

### Product Overview

Qorvo’s QPA2310 is a packaged, high-power C-band amplifier fabricated on Qorvo’s production 0.25  $\mu\text{m}$  GaN on SiC process (QGaN25HV). Covering 5.0–6.0 GHz, the QPA2310 provides 48 dBm of saturated output power and 23 dB of large-signal gain while achieving 49 % power-added efficiency.

The QPA2310 is packaged in a 7 mm x 7 mm 48-pin plastic overmolded package. It can support a variety of operating conditions to best support system requirements. With good thermal properties, it can support a range of bias voltages.

The QPA2310 MMIC has DC blocking capacitors on both RF ports, which are matched to 50 ohms. The QPA2310 is ideal for military radar systems.

Lead-free and RoHS compliant.

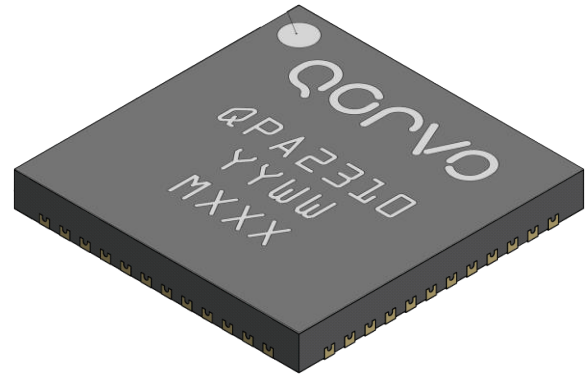

### Key Features

- Frequency Range: 5.0–6.0 GHz
- $P_{SAT}$  ( $P_{IN}=25$  dBm): 48 dBm
- PAE ( $P_{IN}=25$  dBm): 49 %
- Power Gain ( $P_{IN}=25$  dBm): 23 dB
- Bias:  $V_D = 50$  V,  $I_{DQ} = 300$  mA
- Package Dimensions: 7.0 x 7.0 x 0.82 mm

*Performance is typical across frequency. Please reference electrical specification table and data plots for more details.*

### Functional Block Diagram

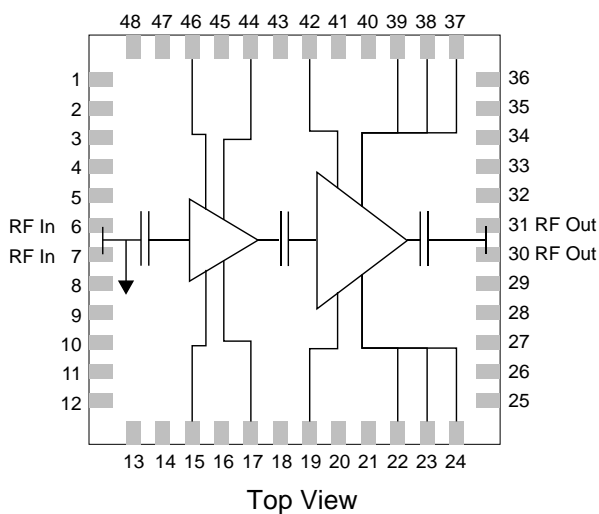

### Applications

- Radar

### Ordering Information

Part No.	Description
QPA2310	5.0 – 6.0 GHz 150 W GaN Power Amplifier (10 Pcs.)
QPA2310TR7	250 piece 7" reel
QPA2310EVB	Evaluation Board for QPA2310

## Absolute Maximum Ratings

Parameter	Value / Range
Drain Voltage ( $V_D$ )	55 V
Gate Voltage Range ( $V_G$ )	-4 to +1 V
Drain Current ( $I_{D1}$ )	1 A
Drain Current ( $I_{D2}$ )	4.5 A
Gate Current ( $I_G$ )	See plot page 10
Power Dissipation ( $P_{DISS}$ ), 85 °C	130 W
Input Power ( $P_{IN}$ ), Pulsed, 50 $\Omega$ , $V_D=50$ V, $I_{DQ}=422$ mA, 85 °C	33 dBm
Input Power ( $P_{IN}$ ), Pulsed, 3:1 VSWR, $V_D=50$ V, $I_{DQ}=422$ mA, 85 °C	33 dBm
Soldering Temperature (30 seconds)	260 °C
Storage Temperature	-55 to 150 °C

Operation of this device outside the parameter ranges given above may cause permanent damage. These are stress ratings only, and functional operation of the device at these conditions is not implied.

## Electrical Specifications

Parameter	Min	Typ	Max	Units
Operational Frequency Range	5.0		6.0	GHz
Saturated Output Power ( $P_{IN} = 28$ dBm)		48		dBm
Power Added Efficiency ( $P_{IN} = 28$ dBm)		49		%
Power Gain ( $P_{IN} = 28$ dBm)		23		dB
Small Signal Gain		29		dB
Input Return Loss		14		dB
Output Return Loss		10		dB
Second Harmonic ( $P_{OUT} = 47$ dBm, 5.5 GHz)		-28		dBc
Third Harmonic ( $P_{OUT} = 47$ dBm, 5.5 GHz)		-37		dBc
Small Signal Temperature Coefficient (-40 °C to 85 °C)		-0.046		dB
Output Power Temperature Coefficient (25 °C to 85 °C)		-0.742		dB
Gate Leakage ( $V_D = 10$ V, $V_G = -3.7$ V)	-16.5			mA

Test conditions, unless otherwise noted: T = 25 °C,  $V_D = 50$  V,  $I_{DQ} = 600$  mA,  $P_{IN} = 28$  dBm, PW = 300  $\mu$ s, Duty Cycle = 20%

## Recommended Operating Conditions

Parameter	Value / Range
Drain Voltage ( $V_D$ )	50 V
Quiescent Drain Current ( $I_{DQ\_TOTAL}$ )	300 mA
Drain Current (Under drive, $I_{D\_TOTAL}$ )	2600 mA
Operating Temperature	-40 to +85 °C

Electrical specifications are measured at specified test conditions. Specifications are not guaranteed over all recommended operating conditions.

## Performance Plots – Large Signal (Pulsed)

Test conditions, unless otherwise noted:  $T = 25\text{ }^{\circ}\text{C}$ ,  $V_D = 50\text{ V}$ ,  $I_{DQ} = 300\text{ mA}$ ,  $P_{IN} = 25\text{ dBm}$ ,  $PW = 300\text{ }\mu\text{s}$ , Duty Cycle = 20%

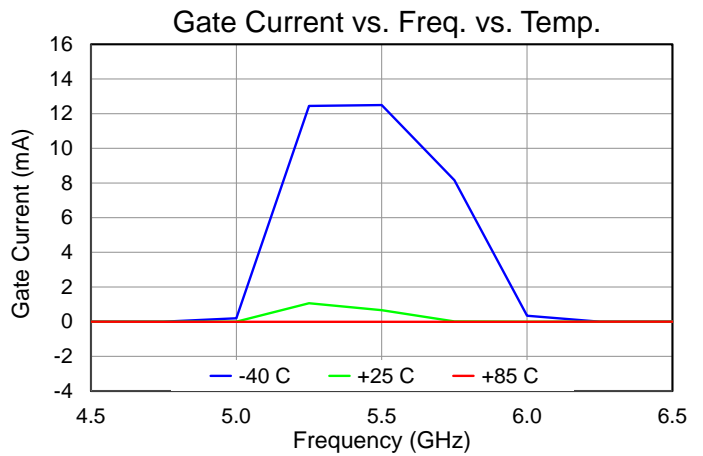
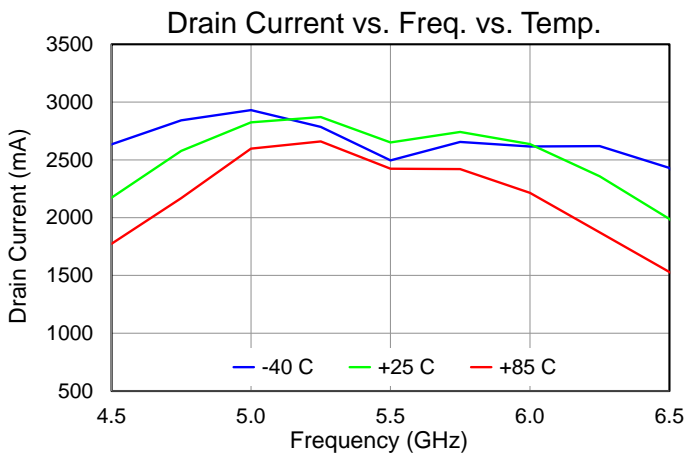
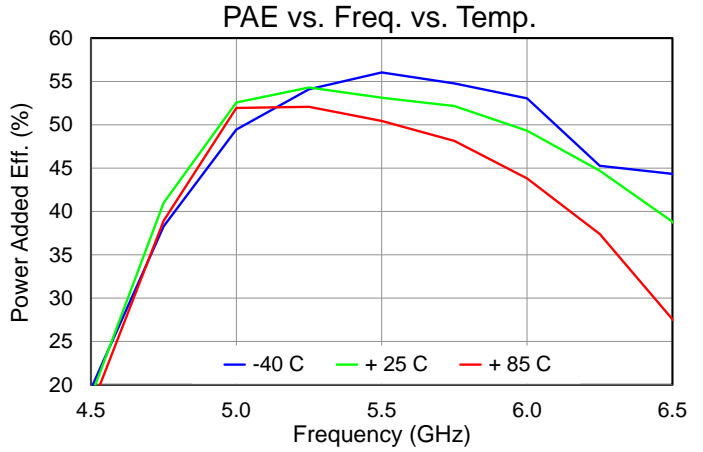
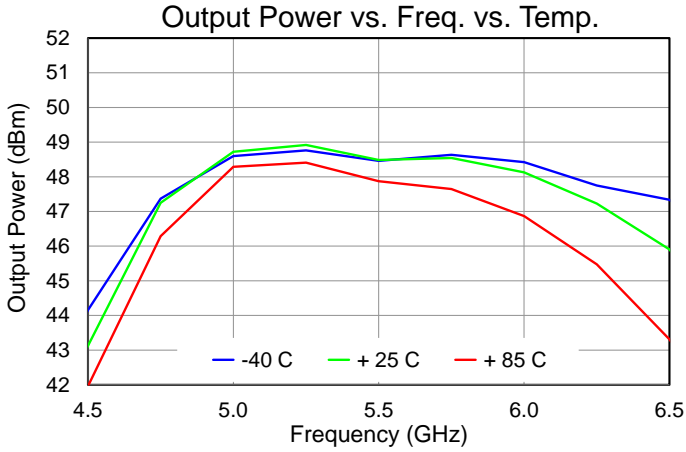

Performance Plots – Large Signal (Pulsed)

Test conditions, unless otherwise noted: T = 25 °C, I<sub>DQ</sub> = 300 mA, P<sub>IN</sub> = 25 dBm, PW = 300 us, Duty Cycle = 20%

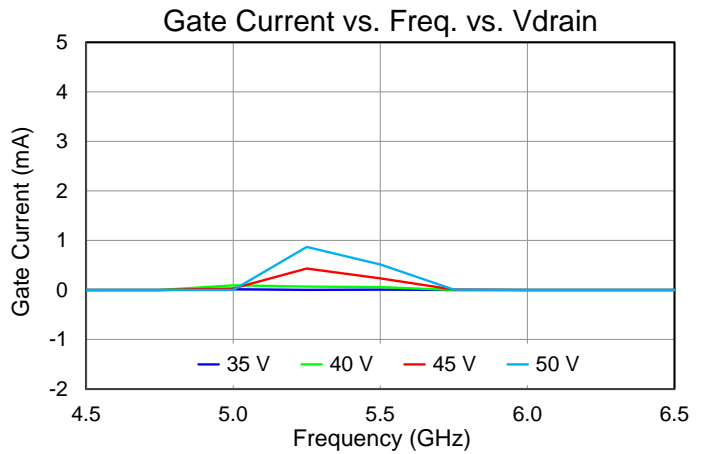
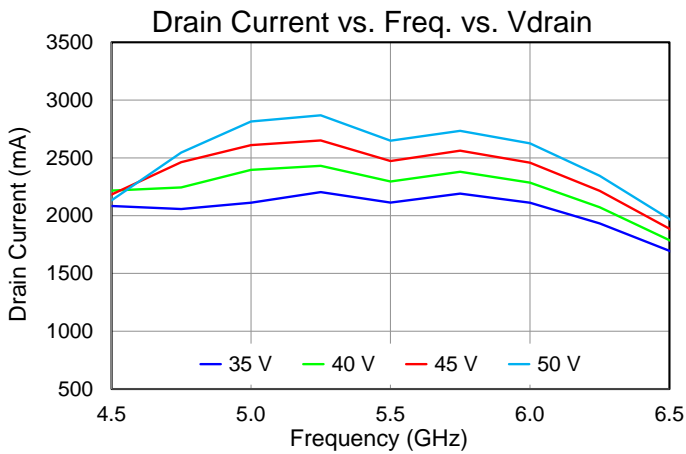
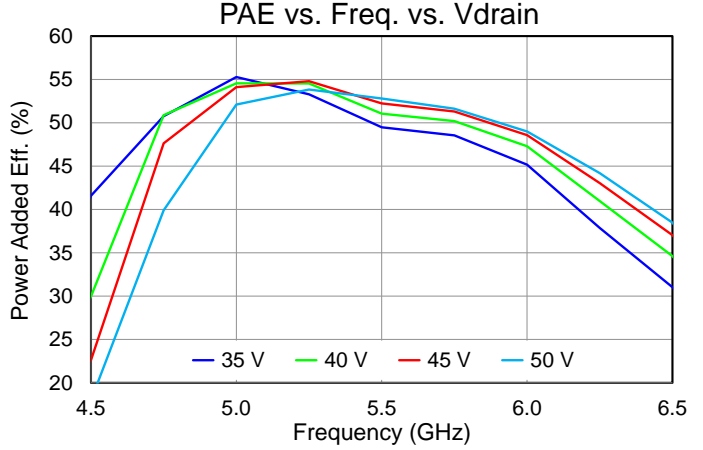
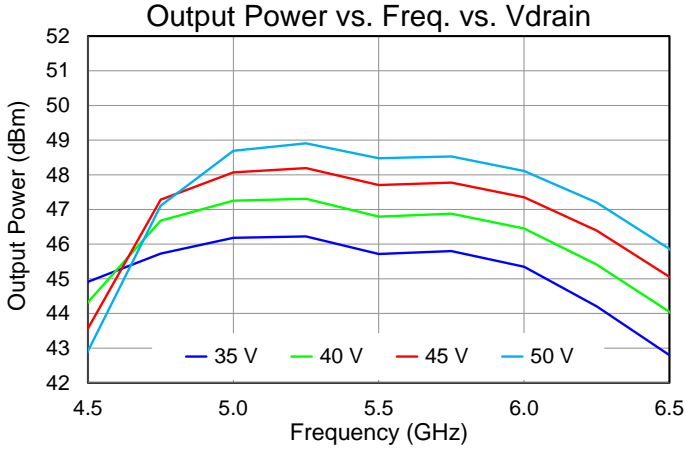

## Performance Plots – Large Signal (Pulsed)

Test conditions, unless otherwise noted:  $T = 25\text{ }^{\circ}\text{C}$ ,  $V_D = 50\text{ V}$ ,  $I_{DQ} = 300\text{ mA}$ ,  $PW = 300\text{ }\mu\text{s}$ , Duty Cycle = 20%

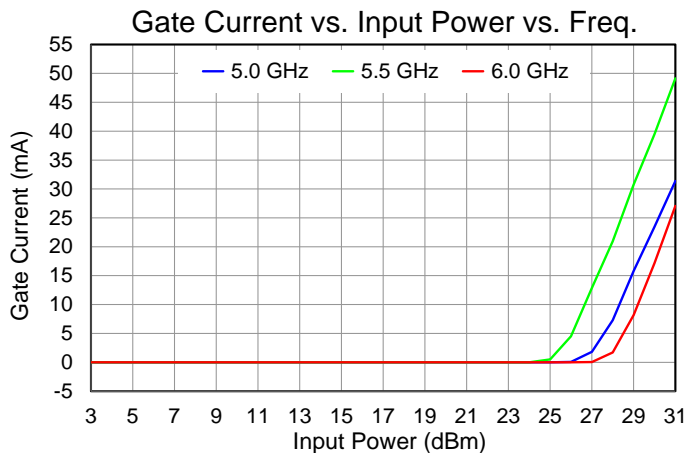
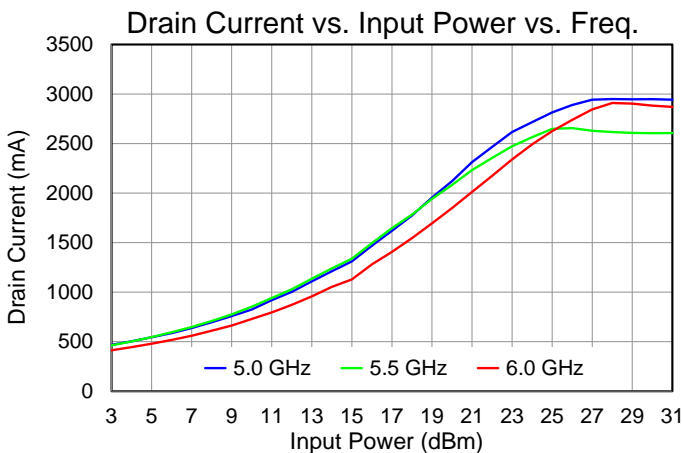
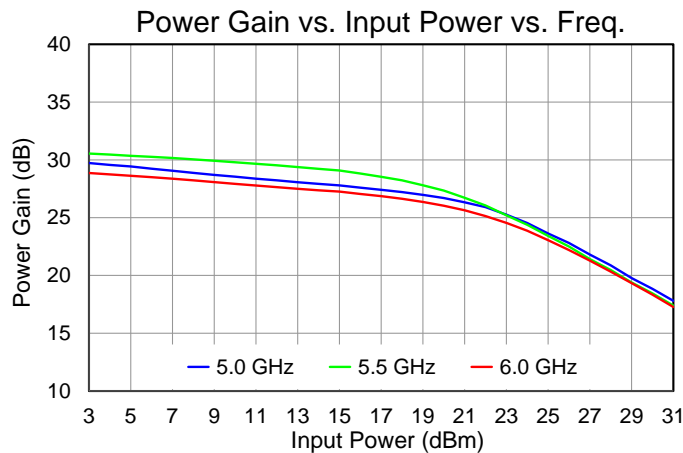
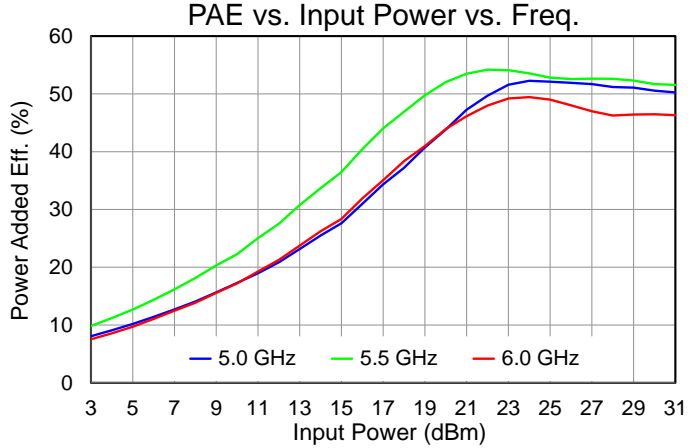
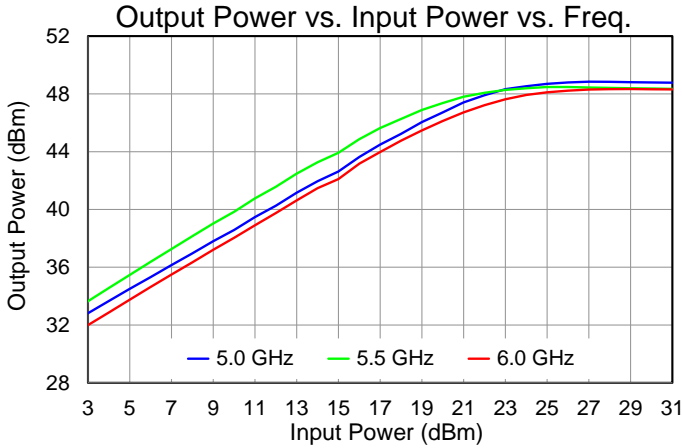

Performance Plots – Large Signal (Pulsed)

Test conditions, unless otherwise noted: T = 25 °C, V<sub>D</sub> = 50 V, I<sub>DQ</sub> = 300 mA, PW = 300 us, Duty Cycle = 20%

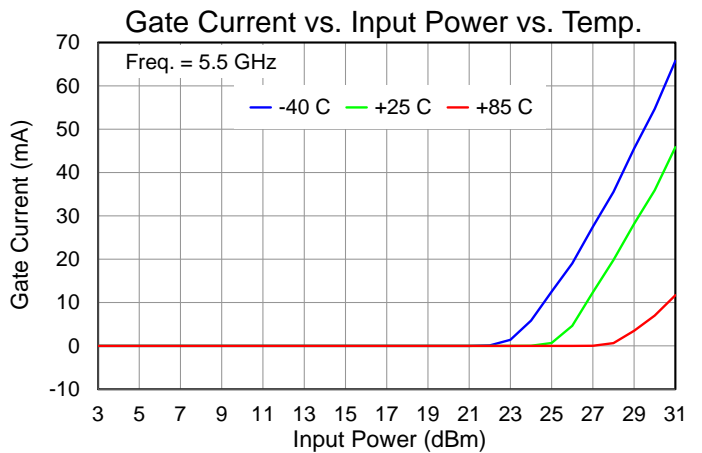
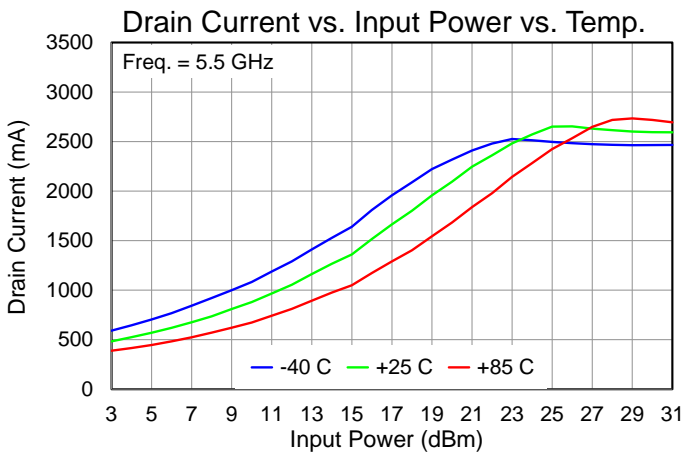
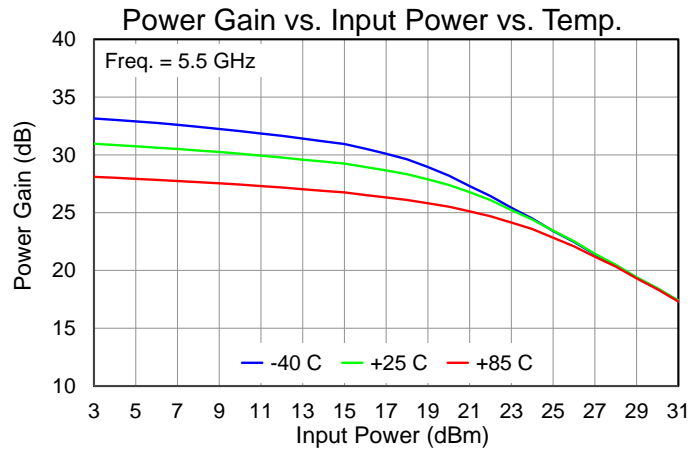
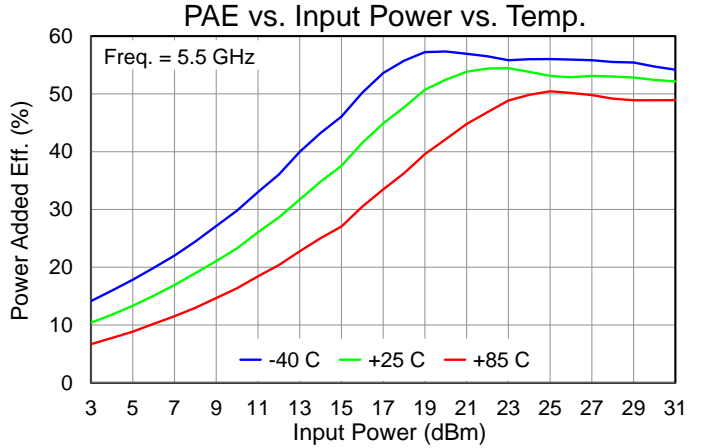
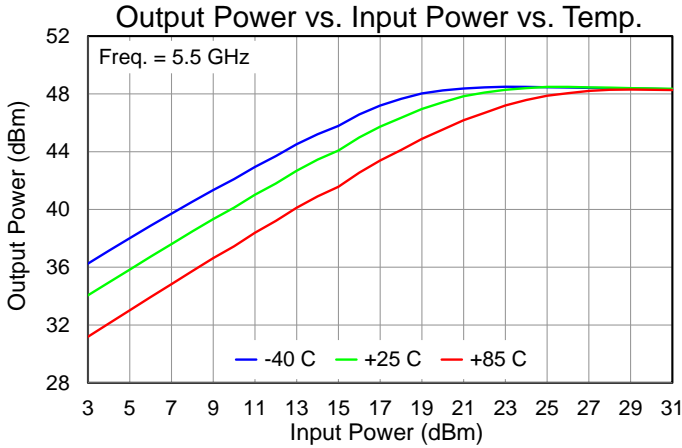

Performance Plots – Large Signal (Pulsed)

Test conditions, unless otherwise noted: T = 25 °C, I<sub>DQ</sub> = 300 mA, PW = 300 us, Duty Cycle = 20%

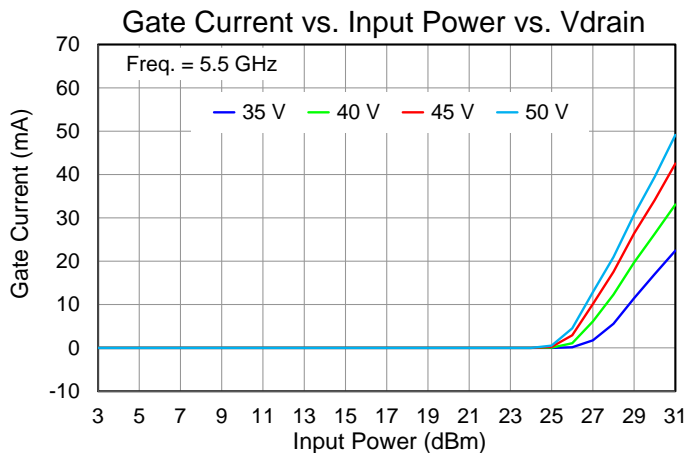
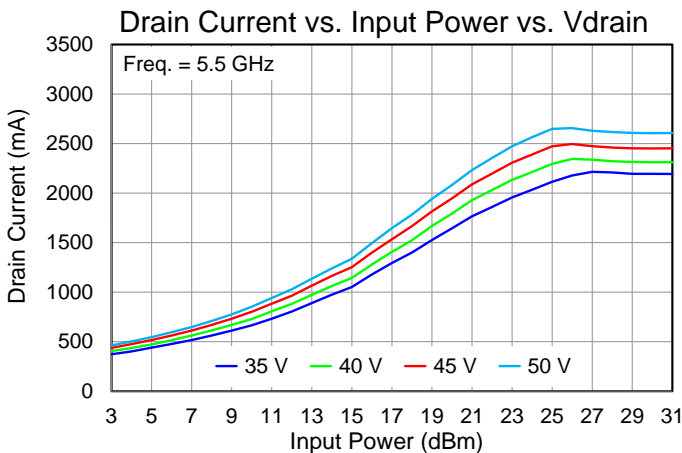
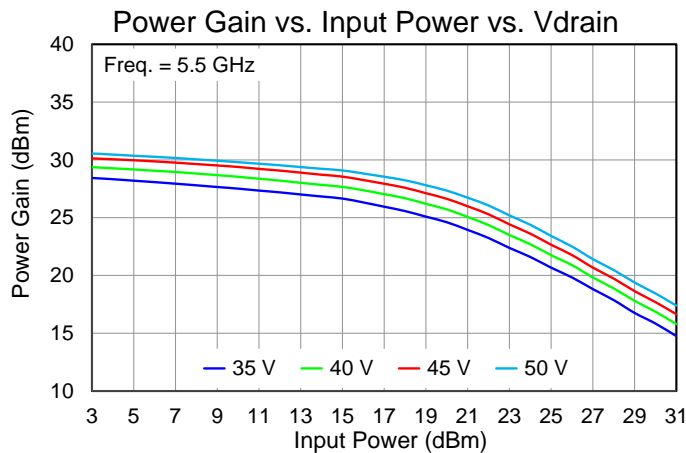
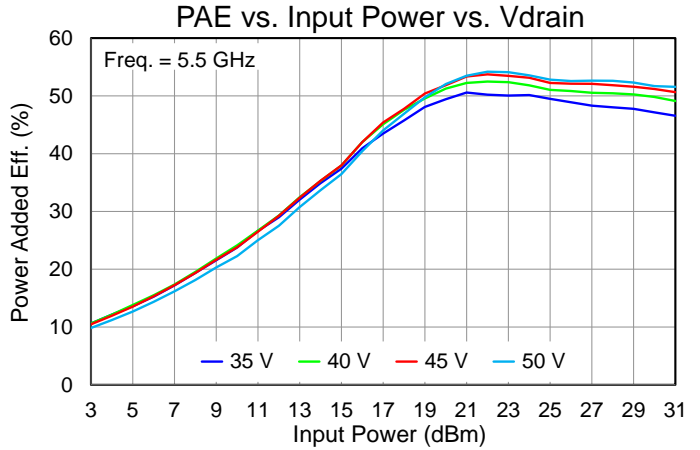
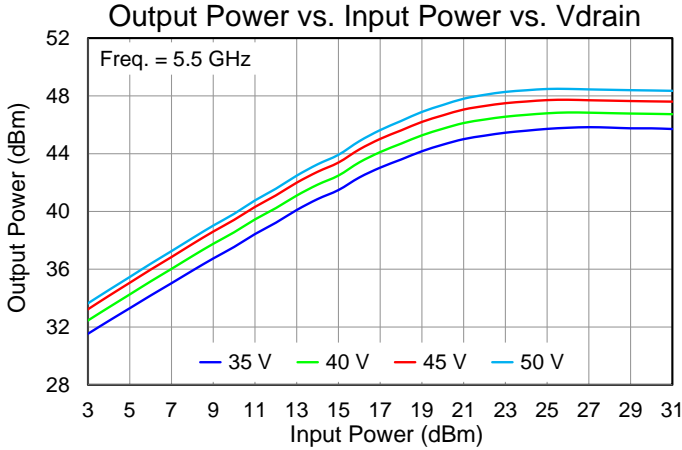

Performance Plots – Harmonics

Test conditions, unless otherwise noted: T = 25 °C, V<sub>D</sub> = 50 V, I<sub>DQ</sub> = 300 mA, PW = 300 us, Duty Cycle = 20%

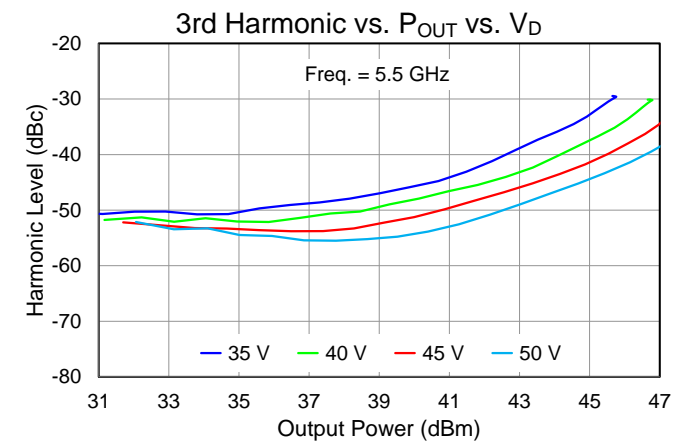
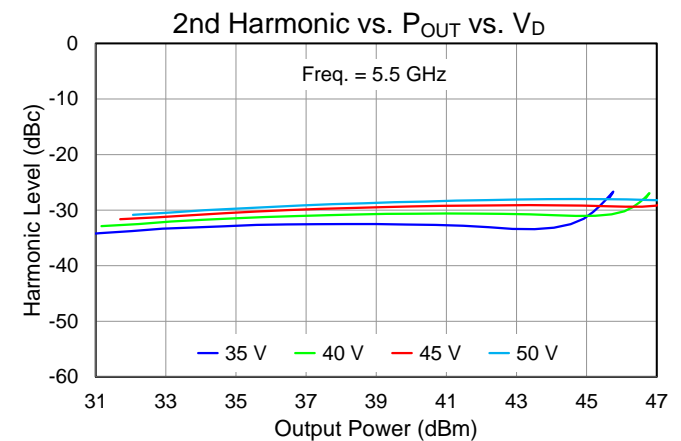
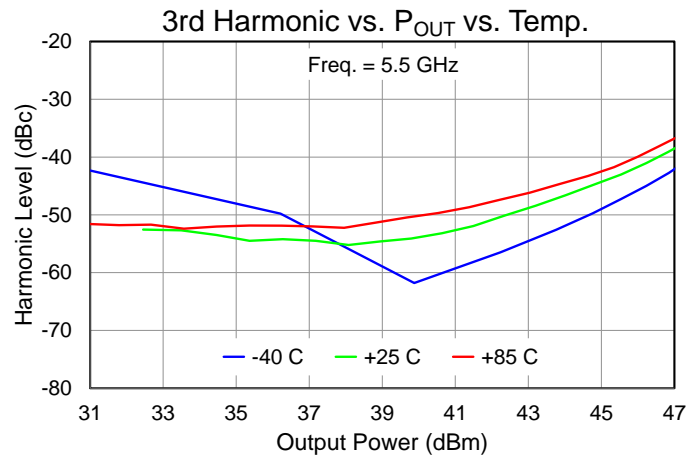
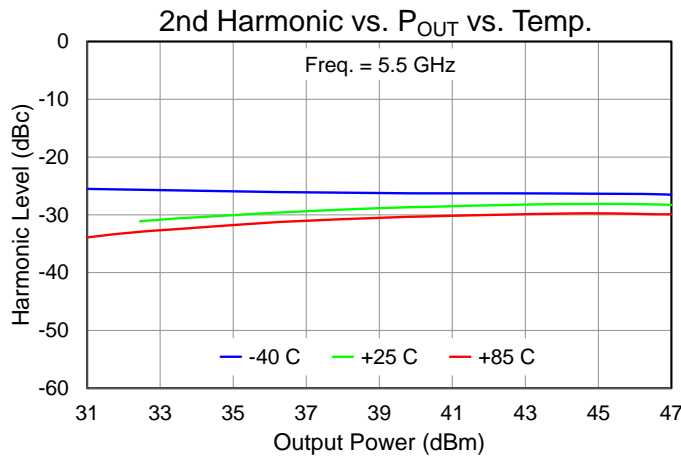
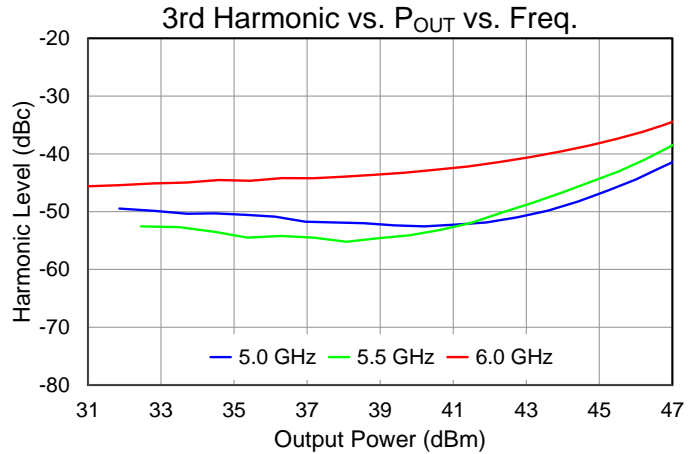
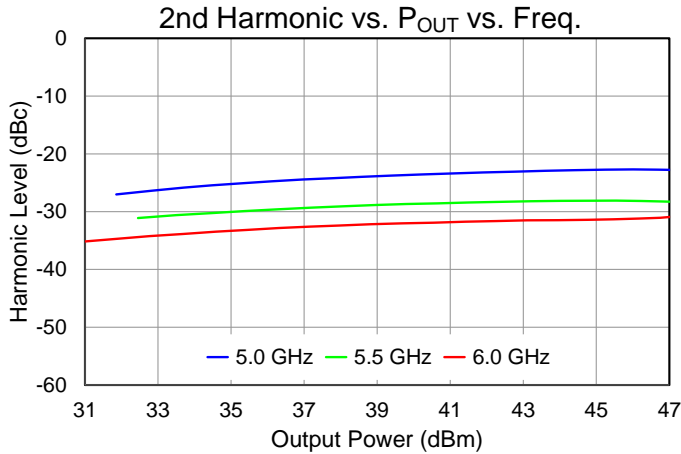

Performance Plots – Small Signal

Test conditions, unless otherwise noted: T = 25 °C, V<sub>D</sub> = 50 V, I<sub>DQ</sub> = 300 mA, CW

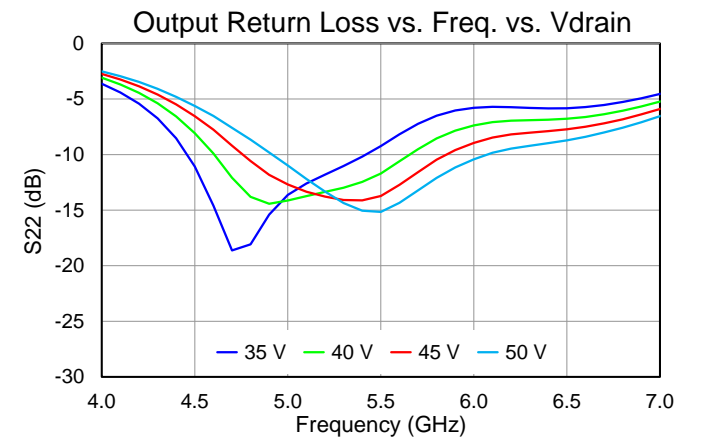
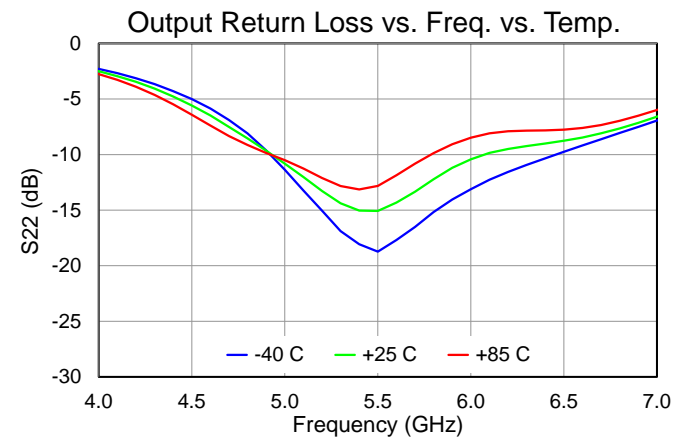
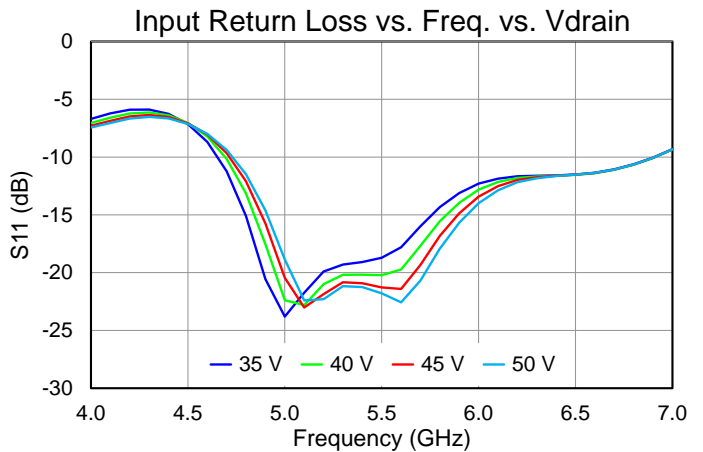
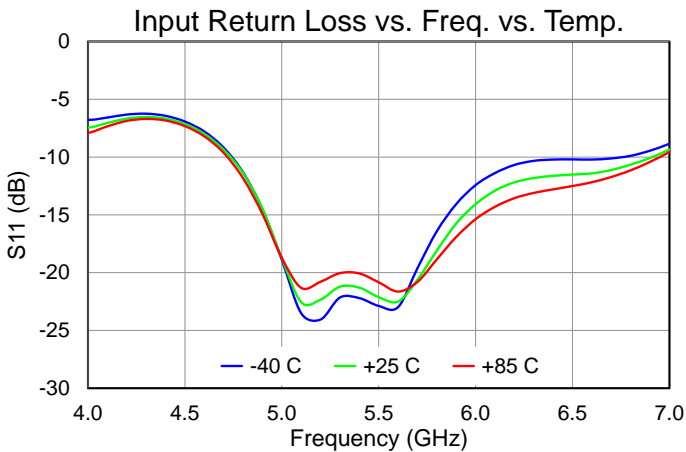
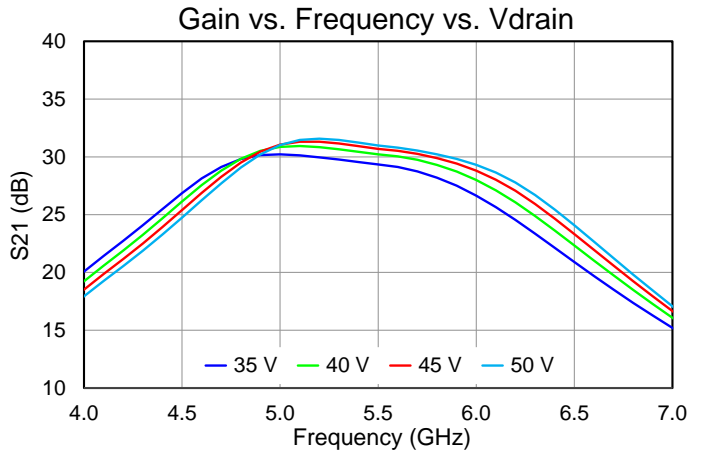
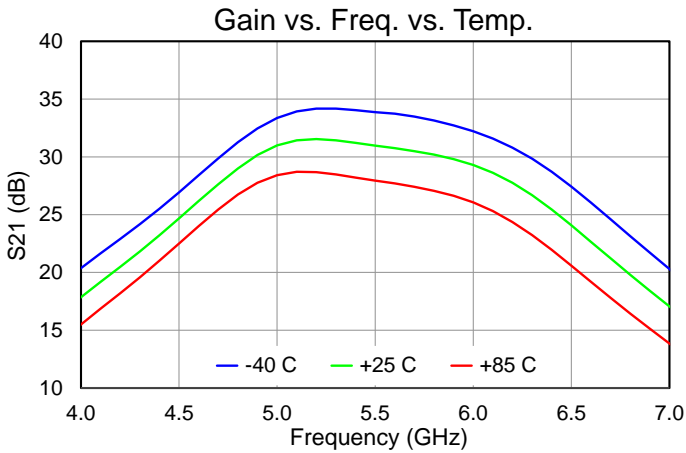

## Thermal and Reliability Information

Parameter	Test Conditions	Value	Units
Thermal Resistance ( $\theta_{JC}$ ) <sup>(1)</sup>	$T_{base} = 85\text{ }^{\circ}\text{C}$ , $V_D = 50\text{ V}$ , $I_{DQ} = 300\text{ mA}$ , $P_{DISS} = 15\text{ W}$ (No RF Drive)	0.897	$^{\circ}\text{C/W}$
Channel Temperature, $T_{CH}$ (No RF drive) <sup>(2)</sup>		98.5	$^{\circ}\text{C}$
Thermal Resistance ( $\theta_{JC}$ ) <sup>(1)</sup>	$T_{base} = 85\text{ }^{\circ}\text{C}$ , $V_D = 50\text{ V}$ , $I_{DQ} = 300\text{ mA}$ , Freq. = 5.25 GHz, $P_{IN} = 25\text{ dBm}$ , $P_{OUT} = 48.4\text{ dBm}$ , $I_{D\_DRIVE} = 2.66\text{ A}$ , $P_{DISS} = 63.5\text{ W}$ , $PW = 300\text{ us}$ , $DC = 20\%$ (Under Drive)	1.085	$^{\circ}\text{C/W}$
Channel Temperature, $T_{CH}$ (w/RF drive) <sup>(2)</sup>		153.9	$^{\circ}\text{C}$

Notes:

1. Thermal resistance determined to the back of the package (fixed at 85  $^{\circ}\text{C}$ )
2. IR scan equivalent. Refer to the following document: [GaN Device Channel Temperature, Thermal Resistance, and Reliability Estimates](#)

## Dissipated Power and Maximum Gate Current

Test conditions, unless otherwise noted:  $T = 25\text{ }^{\circ}\text{C}$ ,  $V_D = 50\text{ V}$ ,  $I_{DQ} = 300\text{ mA}$ ,  $P_{in} = 28\text{ dBm}$ ,  $PW = 300\text{ us}$ , Duty Cycle = 20%

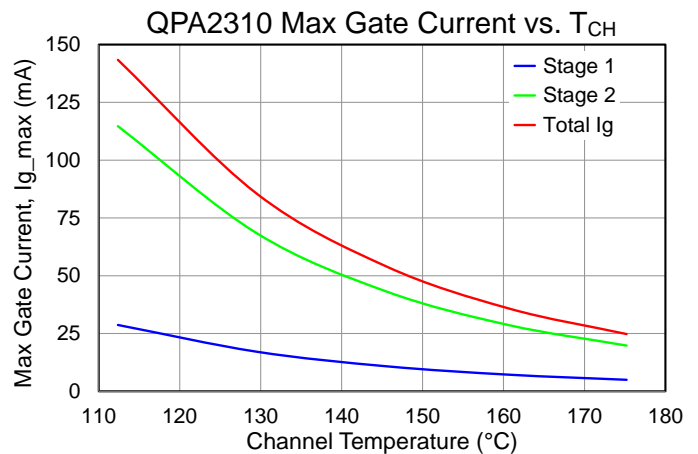
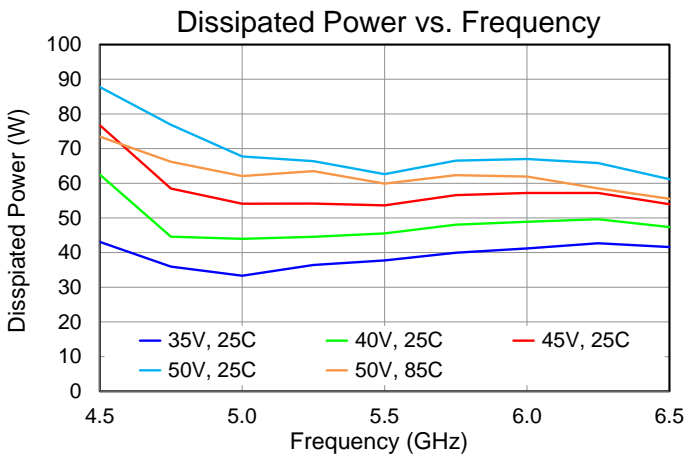



Evaluation Board (EVB) Layout Assembly

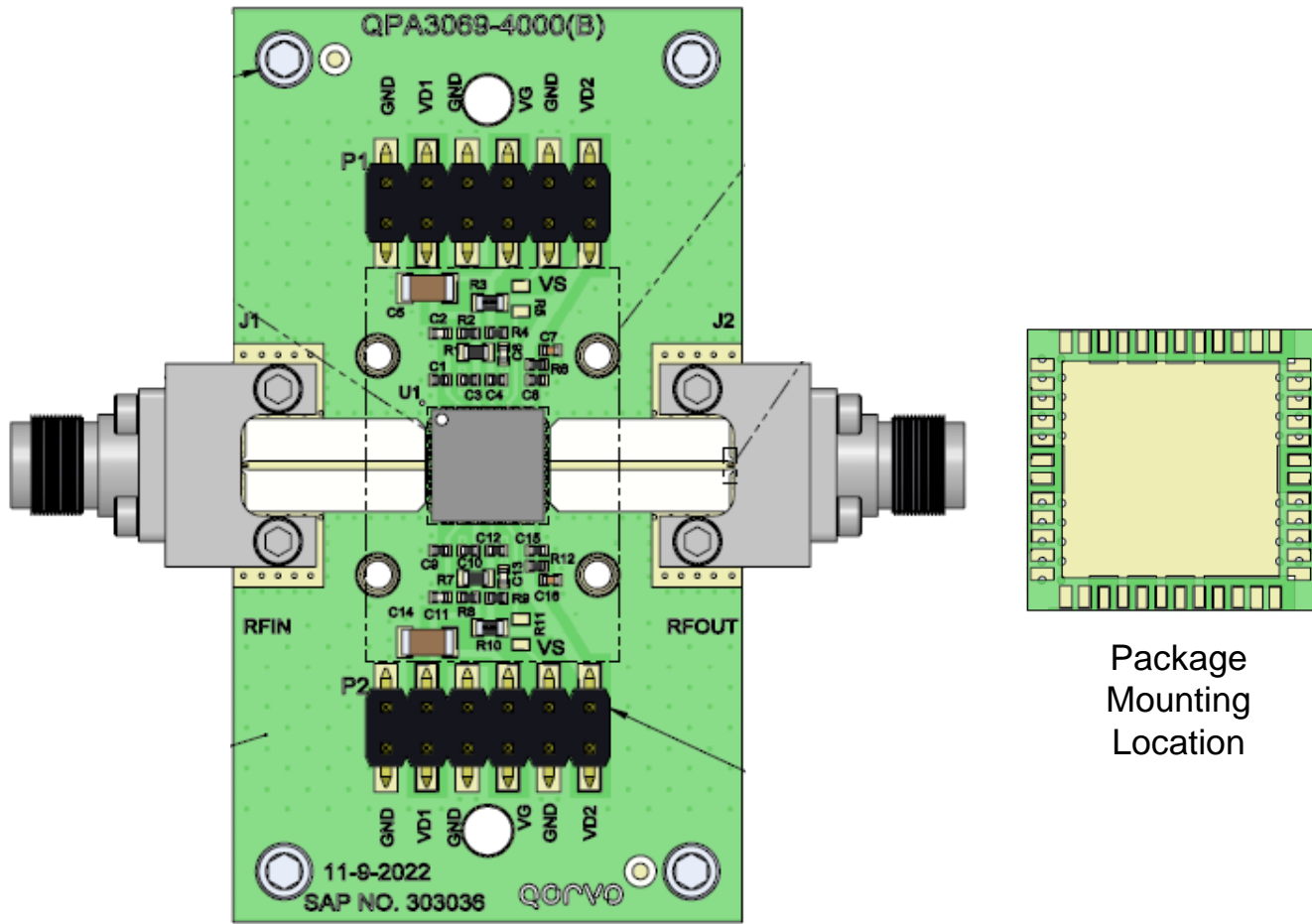

RF PCB is Rogers 6035HTC, 0.010" thick, 0.5 ounce copper on both sides.  
PCB is a single layer board with a copper coin in the center pad for improved thermal conductivity.

**Bias-Up Procedure**

1. Set  $I_D$  (peak) supply limit to 3500 mA,  $I_G$  supply limit to 30 mA
2. Set  $V_G$  to  $-4.0$  V
3. Set  $V_D$  +50 V
4. Adjust  $V_G$  more positive until  $I_{DQ} \approx 300$  mA (peak)
5. Apply RF signal

**Bias-Down Procedure**

1. Turn off RF signal
2. Reduce  $V_G$  to  $-4.0$  V. Ensure  $I_{DQ} \sim 0$ mA
3. Set  $V_D$  to 0 V
4. Turn off  $V_D$  supply
5. Turn off  $V_G$  supply

## Mechanical Information and Pad Description

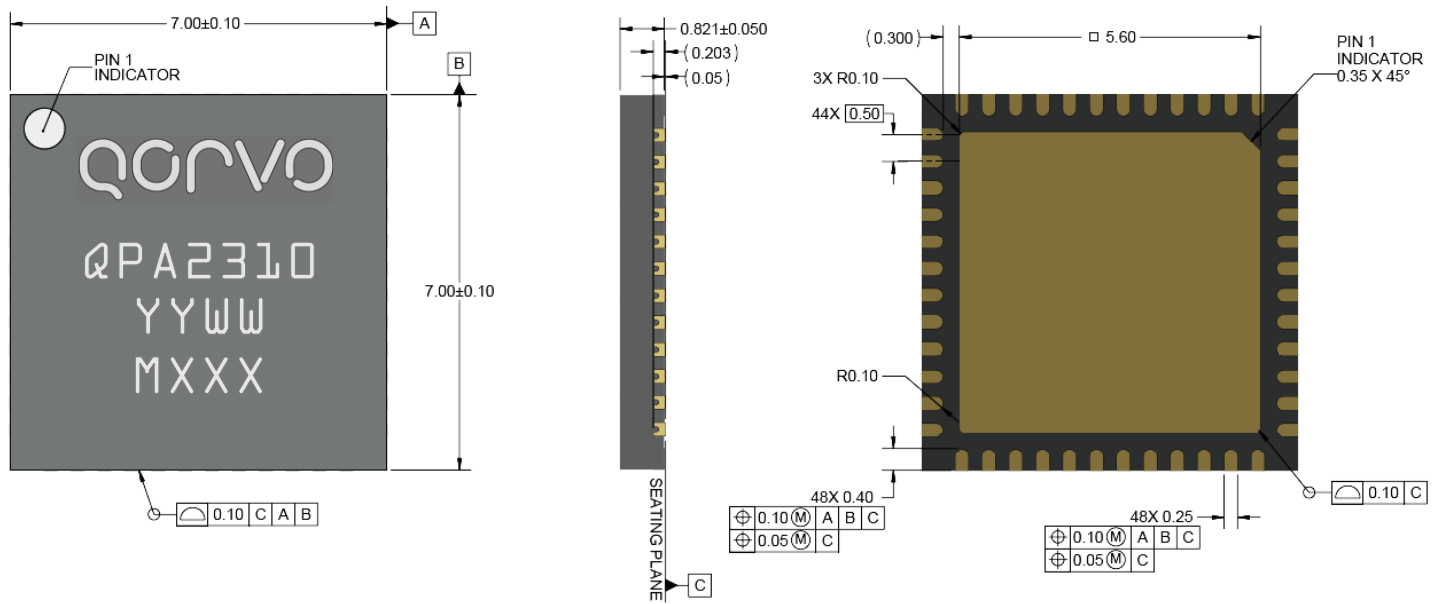

Unless otherwise specified, all dimensions are in mm.  
 Package leads are gold plated.  
 Part is mold encapsulated.  
 Tolerances:  
 .XX = ± 0.25  
 .XXX = ± 0.100  
 .XXXX = ± 0.0254

## Bond Pad Description

Pad No.	Symbol	Description
1-5, 8-14, 16, 18, 20-21, 25-29, 32-36, 40-41, 43, 45, 47-48	NC	No connection. Grounding these pins is recommended, but not required
6, 7	RF INPUT	RF Input; matched to 50 Ω; DC grounded
15, 46	VG1	Gate voltage, stage 1. Bias network is required; see Application Circuit as an example (must be biased from both sides)
17, 44	VD1	Drain voltage, stage 1. Bias network is required; see Application Circuit as an example (must be biased from both sides)
19, 42	VG2	Gate voltage, stage 2. Bias network is required; see Application Circuit as an example (must be biased from both sides)
22-24, 37-39	VD2	Drain voltage, stage 2. Bias network is required; see Application Circuit as an example (must be biased from both sides)
30-31	RF OUTPUT	RF Output; matched to 50 Ω; DC blocked
49 (Center Pad)	GND	Center pad must be grounded to PCB

Assembly Notes

Compatible with lead-free soldering processes with 260°C peak reflow temperature.

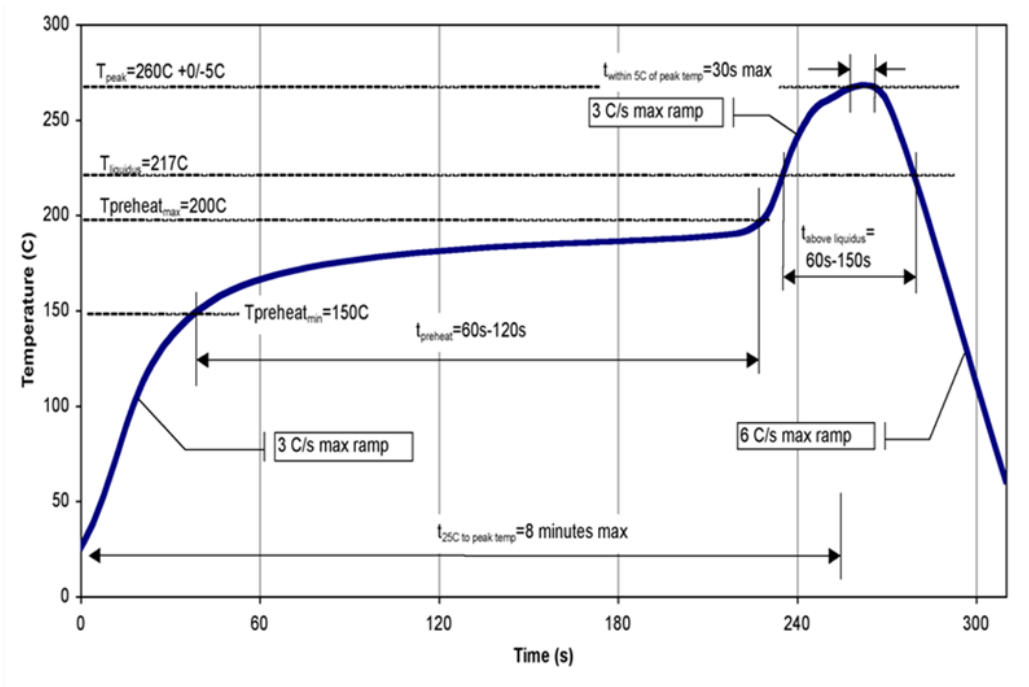

Recommended Soldering Temperature Profile

**Tape and Reel Information – Carrier and Cover Tape Dimensions**

Tape and reel specifications for this part are also available on the Qorvo website.  
Standard T/R size = 250 pieces on a 7" reel.

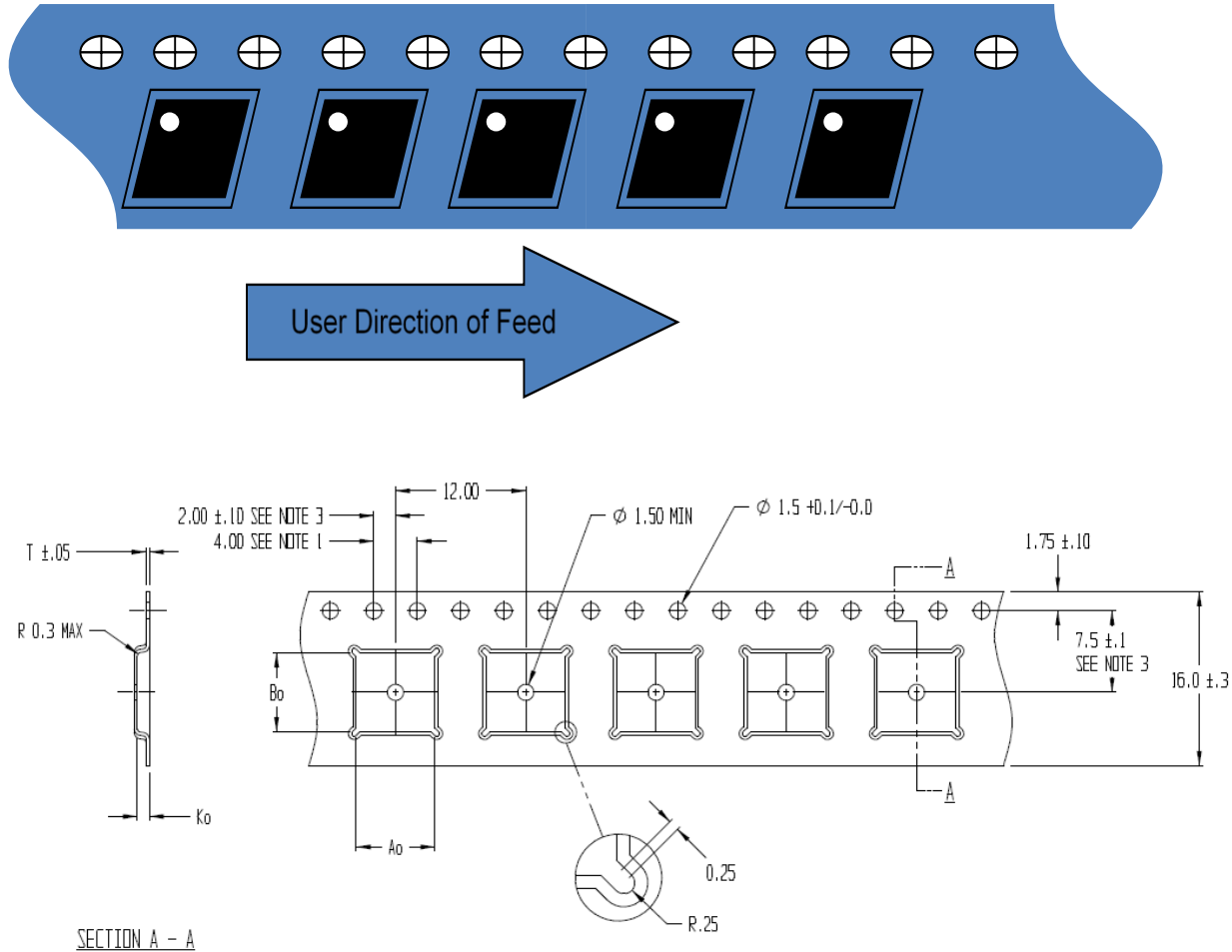

Feature	Measure	Symbol	Size (in)	Size (mm)
Cavity	Length	A0	0.285	7.25
	Width	B0	0.285	7.25
	Depth	K0	0.043	1.10
	Pitch	P1	0.472	12.00
Centerline Distance	Cavity to Perforation - Length Direction	P2	0.079	2.00
	Cavity to Perforation - Width Direction	F	0.295	7.50
Cover Tape	Width	C	0.524	13.30
Carrier Tape	Width	W	0.630	16.00

**Tape and Reel Information – Reel Dimensions**

Packaging reels are used to prevent damage to devices during shipping and storage, loaded carrier tape is typically wound onto a plastic take-up reel. The reel size is 7" diameter. The reels are made from high-impact injection-molded polystyrene (HIPS), which offers mechanical and ESD protection to packaged devices.

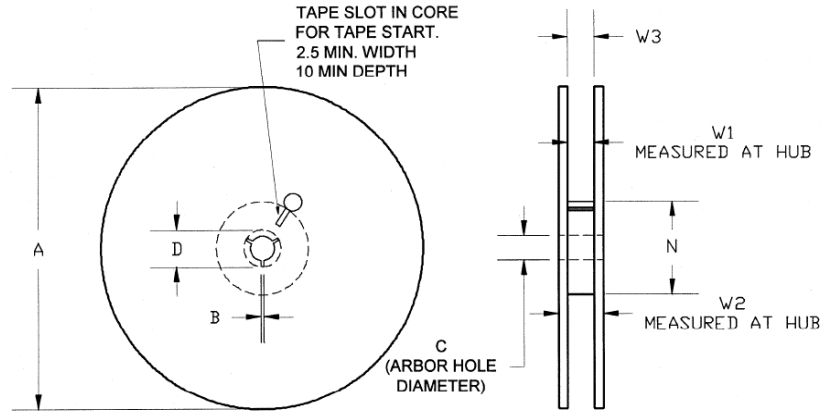

Feature	Measure	Symbol	Size (in)	Size (mm)
Flange	Diameter	A	6.969	177.0
	Thickness	W2	0.724	18.4
	Space Between Flange	W1	0.488	12.4
Hub	Outer Diameter	N	2.283	58.0
	Arbor Hole Diameter	C	0.512	13.0
	Key Slit Width	B	0.079	2.0
	Key Slit Diameter	D	0.795	20.2

**Tape and Reel Information – Tape Length and Label Placement**

Tape and reel specifications for this part are also available on the Qorvo website. Standard T/R size = 250 pieces on a 7" reel.

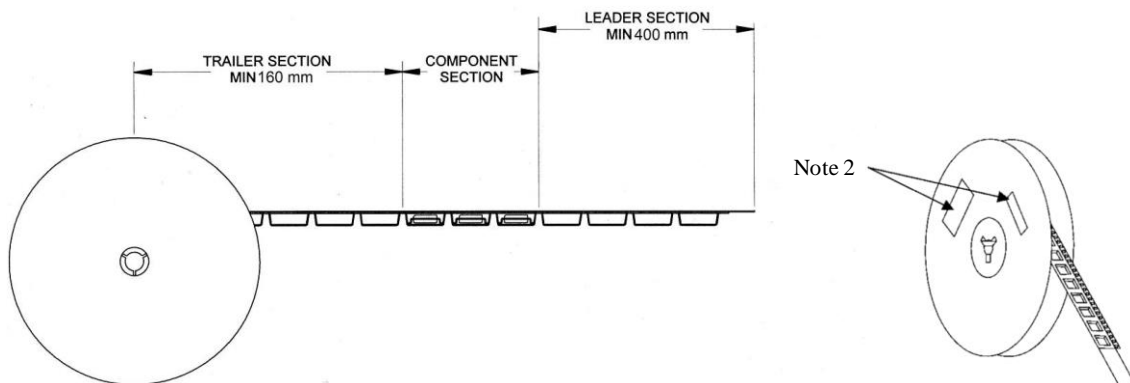

**Notes:**

1. Empty part cavities at the trailing and leading ends are sealed with cover tape. See EIA 481.
2. Labels are placed on the flange opposite the sprockets in the carrier tape.

## Handling Precautions

Parameter	Rating	Standard
ESD – Human Body Model (HBM)	1B	ANSI/ESDA/JEDEC JS-001
ESD – Charge Device Model (CDM)	C3	ANSI/ESDA/JEDEC JS-002
MSL – Moisture Sensitivity Level	MSL3	IPC/JEDEC J-STD-020



Caution!  
 ESD-Sensitive Device

## Solderability

Compatible with the latest version of J-STD-020 Lead-free solder, 260 °C.

## RoHS Compliance

This part is compliant with 2011/65/EU RoHS directive (Restrictions on the Use of Certain Hazardous Substances in Electrical and Electronic Equipment) as amended by Directive 2015/863/EU.

This product also has the following attributes:

- Lead Free
- Halogen Free (Chlorine, Bromine)
- Antimony Free
- TBBP-A (C<sub>15</sub>H<sub>12</sub>Br<sub>4</sub>O<sub>2</sub>) Free
- PFOS Free
- SVHC Free

## Contact Information

For the latest specifications, additional product information, worldwide sales and distribution locations:

**Web:** [www.qorvo.com](http://www.qorvo.com)

**Tel:** 1-844-890-8163

**Email:** [customer.support@qorvo.com](mailto:customer.support@qorvo.com)

## Important Notice

The information contained herein is believed to be reliable; however, Qorvo makes no warranties regarding the information contained herein and assumes no responsibility or liability whatsoever for the use of the information contained herein. All information contained herein is subject to change without notice. Customers should obtain and verify the latest relevant information before placing orders for Qorvo products. The information contained herein or any use of such information does not grant, explicitly or implicitly, to any party any patent rights, licenses, or any other intellectual property rights, whether with regard to such information itself or anything described by such information. **THIS INFORMATION DOES NOT CONSTITUTE A WARRANTY WITH RESPECT TO THE PRODUCTS DESCRIBED HEREIN, AND QORVO HEREBY DISCLAIMS ANY AND ALL WARRANTIES WITH RESPECT TO SUCH PRODUCTS WHETHER EXPRESS OR IMPLIED BY LAW, COURSE OF DEALING, COURSE OF PERFORMANCE, USAGE OF TRADE OR OTHERWISE, INCLUDING THE IMPLIED WARRANTIES OF MERCHANTABILITY AND FITNESS FOR A PARTICULAR PURPOSE.**

Without limiting the generality of the foregoing, Qorvo products are not warranted or authorized for use as critical components in medical, life-saving, or life-sustaining applications, or other applications where a failure would reasonably be expected to cause severe personal injury or death.

© 2024 Qorvo US, Inc. All rights reserved. This document is subject to copyright laws in various jurisdictions worldwide and may not be reproduced or distributed, in whole or in part, without the express written consent of Qorvo US, Inc.

## Looking for pricing, stock, or lifecycle information?

Click below to explore more details on WIN SOURCE:

 [View QPA2310TR7 on WIN SOURCE](#)

 [Qorvo US Inc. Information](#)

## Optimize Your Supply Chain with WIN SOURCE Solutions

-  Global Sourcing Solution
-  Obsolete Management
-  Cost Control Management
-  Shortage Management
-  Alternative Solution
-  Excess Inventory Management