

Typical unit

FEATURES

- DC-DC converter with supporting IEEE802.3af class0 (MYBSP01201ABF or MYBSP00502ABF)
- DC-DC converter with supporting IEEE802.3af class2 (MYBSP01201ABFB or MYBSP00502ABFB)
- 37-57V Input Voltage range
- 14.8 x 26 x 6.2mm Size
- 84% efficiency (typical, 12V_{OUT}).
- Surface mount module
- 2250V Input-Output Isolation
- Operating Temperature range -40 to +85 degC

PRODUCT OVERVIEW

The MYBSP01201ABF / MYBSP00502ABF / MYBSP01201ABFB / MYBSP00502ABFB are an isolated, regulated, DC-DC converter for PoE PD that has an input range of 37-57V with a typical efficiency of 84%(12V_{OUT}), and full 2250 Volt DC isolation.

The MYBSP01201ABF / MYBSP00502ABF / MYBSP01201ABFB / MYBSP00502ABFB are ideal for IEEE 802.3af Compliant Devices. Module has self-protection features. These include input undervoltage lockout and output current limit.

And the modules have detection and classification for compliant IEEE802.3af.

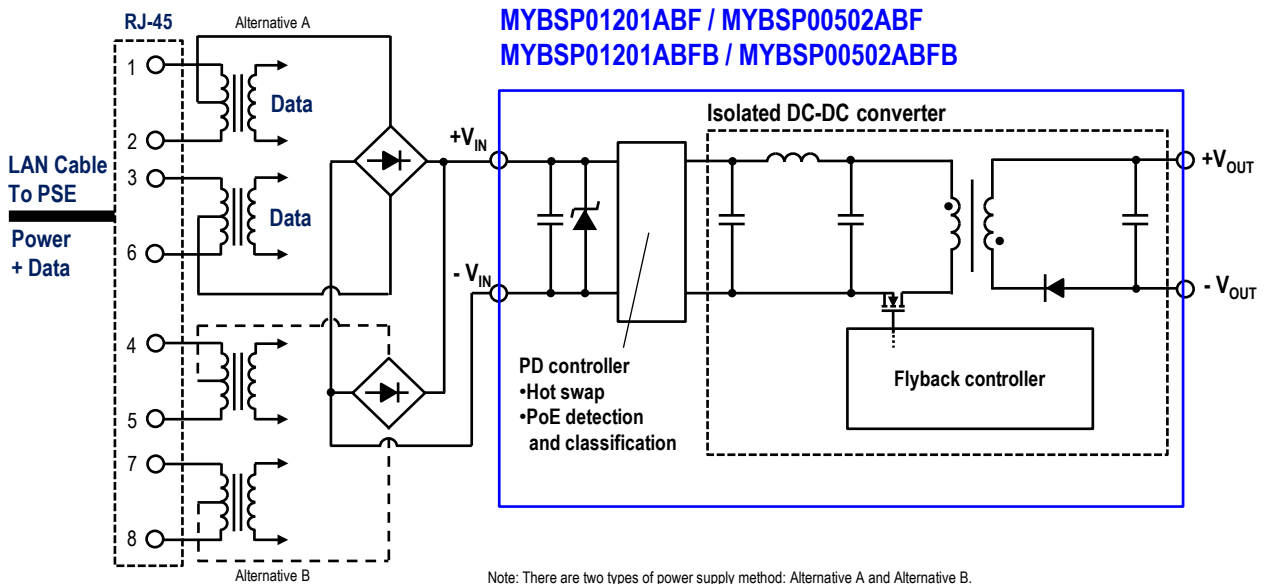

Note: There are two types of power supply method: Alternative A and Alternative B.
 Alternative A: A method that uses the data and power supply lines of 10BASE-T/100BASE-TX in common. It uses pins 1, 2, 3 and 6 of the RJ45 connector.
 Alternative B: Pins 1, 2, 3 and 6 of the RJ45 connector are used for the 10BASE-T/100BASE-TX data lines. On the other hand, pins 4, 5, 7 and 8 of the RJ45 connector, which are not used for the 10BASE-T/100BASE-TX data lines, are used for the power supply lines.

Figure 1. Simplified Block Diagram
Typical topology is shown.

PERFORMANCE SPECIFICATIONS SUMMARY AND ORDERING GUIDE

Model Number	Output						Input			Efficiency [%]		Package [mm]
	V _{OUT} [V]	I _{OUT} (Max.) [A]	Power [W]	R/N Typ. [mVp-p]	Regulation Typ.		V _{IN} Nom. [V]	Range [V]	I _{IN} full load (Typ.) [A]	Min.	Typ.	
					Line [%]	Load [%]						
MYBSP01201ABF	12	1	12	150	±0.4	±0.4	48	37-57	0.3	81	84	14.8 x 26 x 6.2
MYBSP00502ABF	5	2	10	150	±0.6	±0.5	48	37-57	0.3	76	80	
MYBSP01201ABFB	12	0.55	6.6	150	±0.4	±0.4	48	37-57	0.3	80	83	
MYBSP00502ABFB	5	1.3	6.49	150	±0.6	±0.5	48	37-57	0.2	73	77	

- Please refer to the Part Number Structure for additional ordering information and options.
- All specifications are at nominal line voltage, full load, +25degC unless otherwise stated.

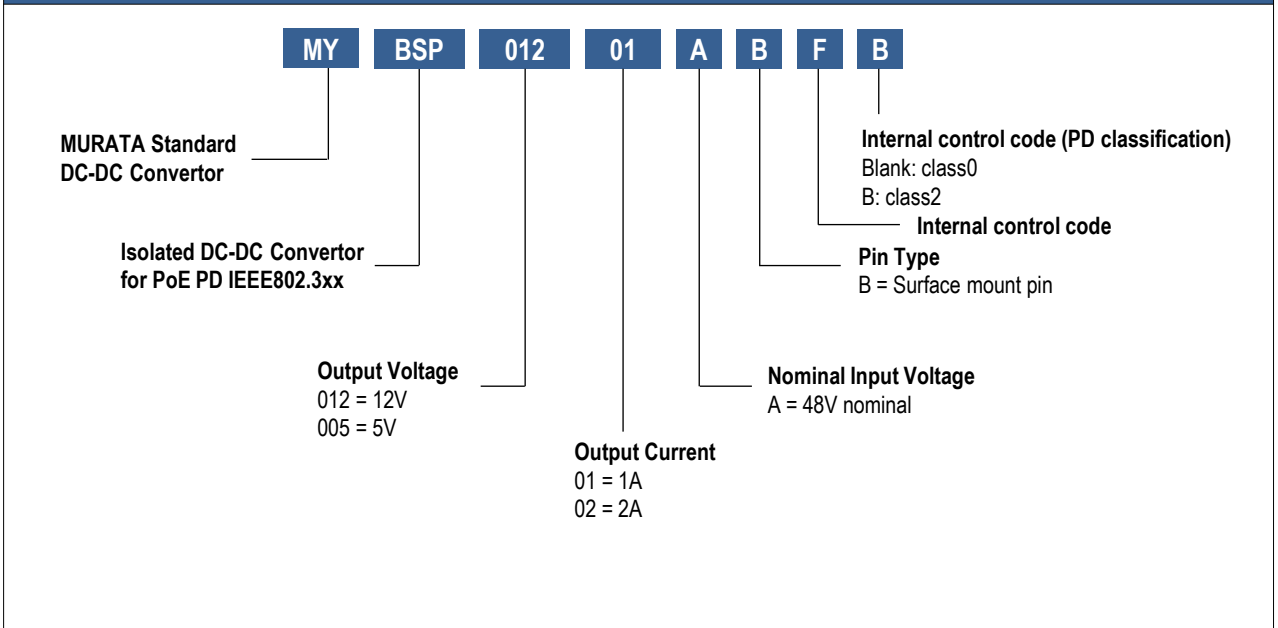
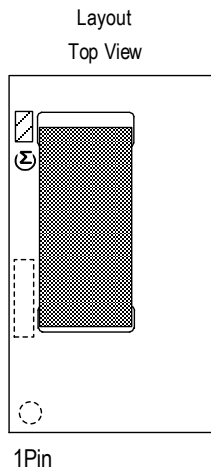
PART NUMBER STRUCTURE

Product Marking

Codes

- Murata Manufacturing ID
- Product Code
- Internal Manufacturing Code

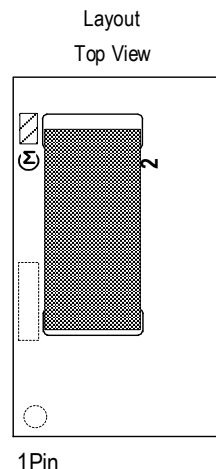
Part Number	Product Code
MYBSP01201ABF	EE
MYBSP00502ABF	EM



Codes

- Murata Manufacturing ID
- Product Code
- Internal Manufacturing Code
- 2** PD Class2

Part Number	Product Code
MYBSP01201ABFB	EE
MYBSP00502ABFB	EM

FUNCTIONAL SPECIFICATIONS, MYBSP01201ABF, MYBSP01201ABFB

Absolute Maximum Ratings	Conditions	Minimum	Typical / Nominal	Maximum	Units
Input Voltage, Continuous		0	-	57	V
Input Voltage, Transient	100ms max. duration	-	-	60	V
Isolation Voltage	Input to output, Leak current 1mA max for 1minute at +25degC/60%RH.	-	-	2250	V
Output Power		0	-	12	W
Output Current	Current-limited, no damage, short-circuit protected	0	-	1	A
Storage Temperature Range	$V_{IN} = \text{Zero}$ (no power)	-40	-	90	degC
Absolute maximums are stress ratings. Exposure of devices to greater than any of these conditions may adversely affect long-term reliability. Proper operation under conditions other than those listed in the Performance/Functional Specifications Table is not implied or recommended.					
INPUT					
Operating Voltage Range	Slew rate less than 30V/us	37	48	57	V
Start-up threshold	Rising input voltage	34.9	37.5	40.1	V
Undervoltage shutdown	Falling input voltage	28.9	31	33.1	V
Internal Filter Type		-	Pi	-	
Input current					
Full Load Conditions	$V_{IN} = \text{nom.}, I_{OUT} = \text{max}$	-	0.3	-	A
Low Line Input current	$V_{IN} = \text{min.}, I_{OUT} = \text{max.}$	-	0.4	-	A
On Resistance of Internal Hotswap			0.48	-	Ω
Resistance for detection	$V_{IN} = 2.7$ to 10.1V	-	25	-	k Ω
Classification current	$V_{IN} = 14.5$ to 20.5V	MYBSP01201ABF	-	2	mA
		MYBSP01201ABFB	-	18.5	mA
GENERAL and SAFETY					
Efficiency	$V_{IN} = 48\text{V}$, full load	81	84	-	%
	$V_{IN} = 48\text{V}$, $I_{OUT} = 0.55\text{A}$	80	83	-	%
Isolation					
Isolation Voltage	Input to output, Leak current 1mA max for 1minute at +25degC/60%RH.	2250	-	-	V
Insulation Safety Rating		-	Functional	-	
Isolation Capacitance		-	1500	-	pF
Calculated MTBF	Telcordia SR-332, issue 1, class 3, ground fixed, $T_a = +25\text{degC}$	-	4406	-	Hours x 10 ³
DYNAMIC CHARACTERISTIC					
Fixed Switching Frequency *1	$V_{IN} = 48\text{V}$, $I_{OUT} = \text{max}$	-	110	-	kHz
	$V_{IN} = 48\text{V}$, $I_{OUT} = 0.55\text{A}$	-	60	-	kHz
V_{OUT} Rise Time	From 10%-90% of V_{OUT}	-	4	-	ms
Dynamic Load Response	50-100-50% load step to 1% of V_{OUT}	-	500	-	uSec
Dynamic Load Peak Deviation	same as above	-	100	-	mV

FUNCTIONAL SPECIFICATIONS, MYBSP01201ABF, MYBSP01201ABFB

OUTPUT	Conditions	Minimum	Typical / Nominal	Maximum	Units
Total Output Power		0	-	12	W
Voltage					
Nominal Output Voltage	$I_{OUT} = 0.1A$ to max *2	11.4	12	12.6	V
Oversvoltage Protection		-	None	-	V
Current					
Output Current Range *3		0	-	1	A
Current Limit Inception		1.05	-	-	A
Short circuit protection method		-	Non-latching	-	
Regulation					
Line Regulation	$V_{IN} = \text{min to max.}, V_{OUT} = \text{nom.}, \text{full load}$	-	0.4	-	% of V_{OUT}
Load Regulation	$I_{OUT} = 0.1A$ to max.	-	0.4	-	% of V_{OUT}
Ripple and Noise	150 MHz BW, $C_{OUT} = 0.1\mu F$ MLCC paralleled with 10 μF and 100 μF	-	150	300	mV pk-pk
Maximum Capacitive Loading	Low ESR	100	-	400	μF
MECHANICAL					
Outline Dimensions	L x W x H	-	14.8 x 26 x 6.2	-	mm
Weight		-	4.5	-	Grams
Pin Diameter		-	1.6	-	mm
Pin Material		-	Copper alloy	-	
ENVIRONMENTAL					
Operating Ambient Temperature Range		-40	-	85	degC
Storage Temperature	$V_{IN} = \text{Zero (no power)}$	-40	-	90	degC
Electromagnetic Interference Conducted, EN55022/CISPR22	External filter is required	-	A	-	Class
Moisture Sensitivity Level			2 Equivalent		

Specification Notes

Unless otherwise noted, all specifications are typical at nominal input voltage, nominal output voltage and full load. General conditions are +25degC ambient temperature, near sea level altitude, natural convection airflow. All models are tested and specified with external parallel 0.1 μF and 10 μF and 100 μF output capacitors (See Technical Notes).

- *1 Variable Frequency Operation.
This module emits audible noise at light load.
- *2 Maximum output voltage is 14.4V if I_{OUT} is less than 0.1A.
- *3 Input current must be greater than or equal to 10mA if your application applies Maintain Power Signature(MPS) by IEEE802.3af. Please check with your application.

PERFORMANCE DATA, MYBSP01201ABF, MYBSP01201ABFB

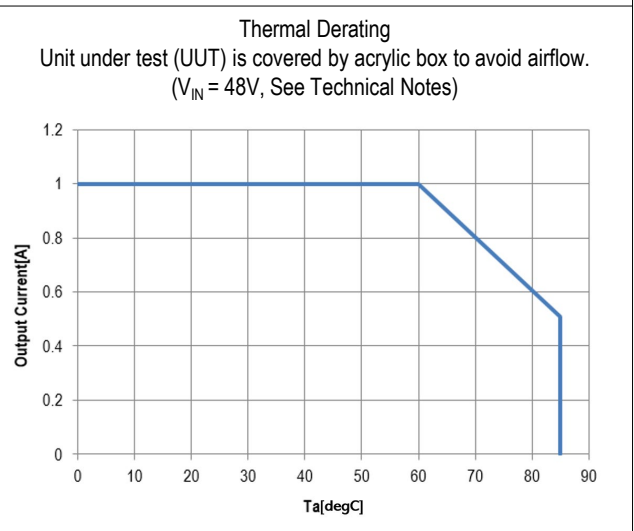
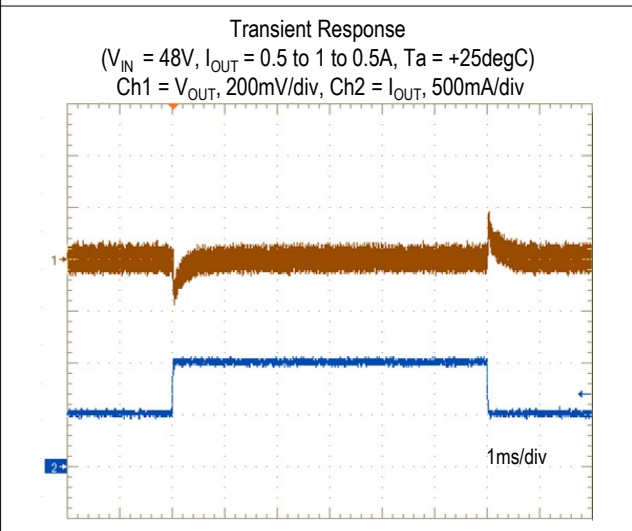
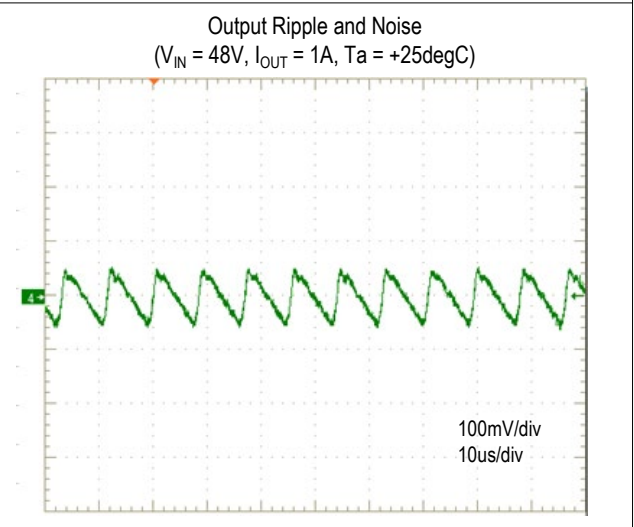
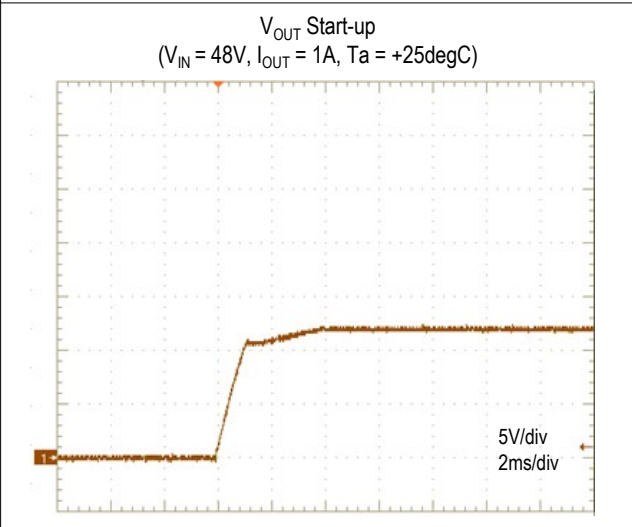
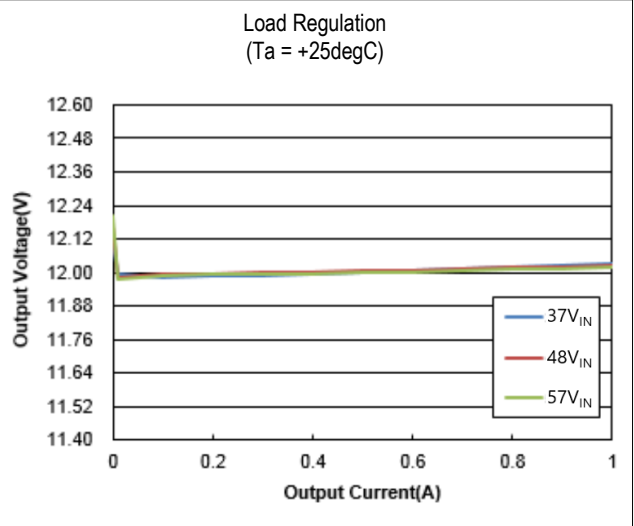
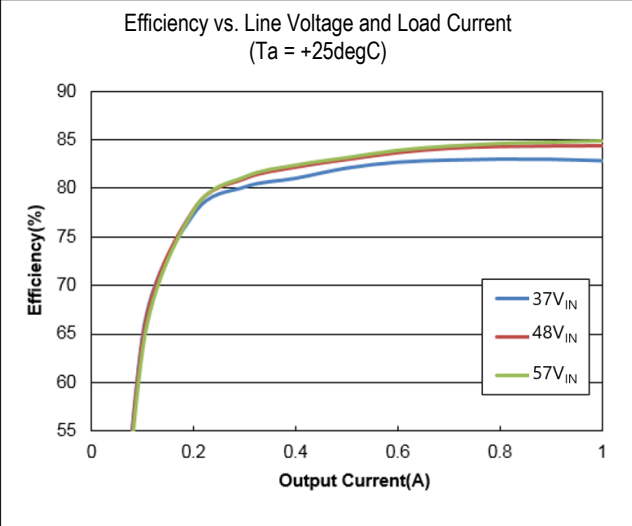

PERFORMANCE DATA, MYBSP01201ABF, MYBSP01201ABFB(CONT.)

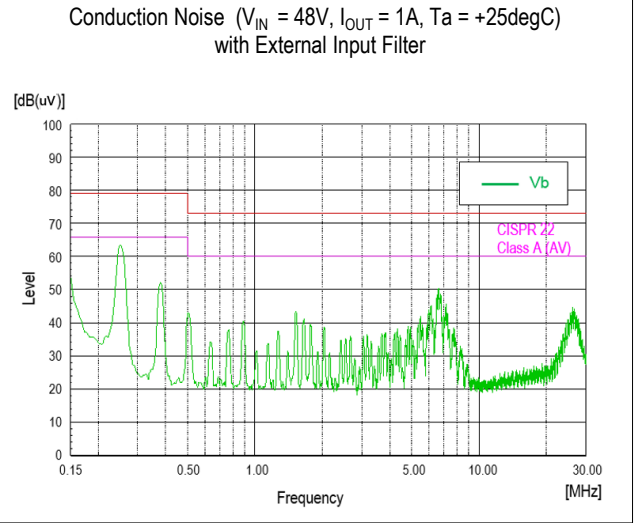
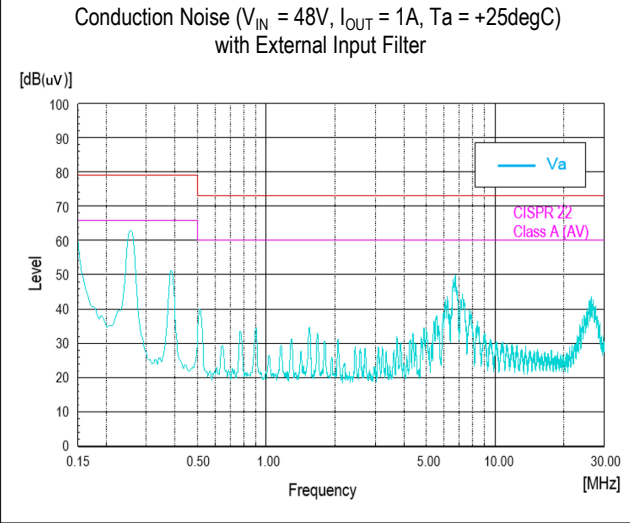

FUNCTIONAL SPECIFICATIONS, MYBSP00502ABF, MYBSP00502ABFB

ABSOLUTE MAXIMUM RATINGS	Conditions	Minimum	Typical / Nominal	Maximum	Units	
Input Voltage, Continuous		0	-	57	V	
Input Voltage, Transient	100ms max. duration	-	-	60	V	
Isolation Voltage	Input to output, Leak current 1mA max for 1minute at +25degC/60%RH.	-	-	2250	V	
Output Power		0	-	10	W	
Output Current	Current-limited, no damage, short-circuit protected	0	-	2	A	
Storage Temperature Range	$V_{IN} = \text{Zero (no power)}$	-40	-	90	degC	
Absolute maximums are stress ratings. Exposure of devices to greater than any of these conditions may adversely affect long-term reliability. Proper operation under conditions other than those listed in the Performance/Functional Specifications Table is not implied or recommended.						
INPUT						
Operating Voltage Range	Slew rate less than 30V/us	37	48	57	V	
Start-up threshold	Rising input voltage	34.9	37.5	40.1	V	
Undervoltage shutdown	Falling input voltage	28.9	31	33.1	V	
Internal Filter Type		-	Pi	-		
Input current						
Full Load Conditions	$V_{IN} = \text{nom.}, I_{OUT} = \text{max}$	-	0.3	-	A	
Low Line Input current	$V_{IN} = \text{min.}, I_{OUT} = \text{max.}$	-	0.4	-	A	
On Resistance of Internal Hotswap		-	0.48	-	Ω	
Resistance for detection	$V_{IN} = 2.7$ to 10.1V	-	25	-	k Ω	
Classification current	$V_{IN} = 14.5$ to 20.5V	MYBSP00502ABF	-	2	-	mA
		MYBSP00502ABFB	-	18.5	-	mA
GENERAL and SAFETY						
Efficiency	$V_{IN} = 48\text{V}$, full load	76	80	-	%	
	$V_{IN} = 48\text{V}$, $I_{OUT} = 1.3\text{A}$	73	77	-	%	
Isolation						
Isolation Voltage	Input to output, Leak current 1mA max for 1minute at +25degC/60%RH.	2250	-	-	V	
Insulation Safety Rating		-	Functional	-		
Isolation Capacitance		-	1500	-	pF	
Calculated MTBF	Telcordia SR-332, issue 1, class 3, ground fixed, $T_a = +25\text{degC}$	-	5605	-	Hours x 10 ³	
DYNAMIC CHARACTERISTIC						
Fixed Switching Frequency *1	$V_{IN} = 48\text{V}$, $I_{OUT} = \text{max}$	-	100	-	kHz	
	$V_{IN} = 48\text{V}$, $I_{OUT} = 1\text{A}$	-	60	-	kHz	
V_{OUT} Rise Time	From 10-90% of V_{OUT}	-	1	-	ms	
Dynamic Load Response	50-100-50% load step to 1% of V_{OUT}	-	500	-	uSec	
Dynamic Load Peak Deviation	same as above	-	100	-	mV	

FUNCTIONAL SPECIFICATIONS, MYBSP00502ABF, MYBSP00502ABFB

OUTPUT	Conditions	Minimum	Typical / Nominal	Maximum	Units
Total Output Power		0	-	10	W
Voltage					
Nominal Output Voltage	$I_{OUT} = 0.2A$ to max *2	4.7	5	5.3	V
Overvoltage Protection		-	None	-	V
Current					
Output Current Range *3		0	-	2	A
Current Limit Inception		2.1	-	-	A
Short circuit protection method		-	Non-latching	-	
Regulation					
Line Regulation	$V_{IN} = \text{min. to max.}, V_{OUT} = \text{nom.}, \text{full load}$	-	0.6	-	% of V_{OUT}
Load Regulation	$I_{OUT} = 0.2A$ to max.	-	0.5	-	% of V_{OUT}
Ripple and Noise	150 MHz BW, $C_{OUT} = 0.1\mu F$ MLCC paralleled with 10 μF and 300 μF	-	150	300	mV pk-pk
Maximum Capacitive Loading	Low ESR	300	-	600	μF
MECHANICAL					
Outline Dimensions	L x W x H	-	14.8 x 26 x 6.2	-	mm
Weight		-	4.7	-	Grams
Pin Diameter		-	1.6	-	mm
Pin Material		-	Copper alloy	-	
ENVIRONMENTAL					
Operating Ambient Temperature Range		-40	-	85	degC
Storage Temperature	$V_{IN} = \text{Zero (no power)}$	-40	-	90	degC
Electromagnetic Interference Conducted, EN55022/CISPR22	External filter is required	-	A	-	Class
Moisture Sensitivity Level		2 Equivalent			

Specification Notes

Unless otherwise noted, all specifications are typical at nominal input voltage, nominal output voltage and full load. General conditions are +25degC ambient temperature, near sea level altitude, natural convection airflow. All models are tested and specified with external parallel 0.1 μF and 10 μF and 300 μF output capacitors (See Technical Notes).

- *1 Variable Frequency Operation.
This module emits audible noise at light load.
- *2 Maximum output voltage is 6V if I_{OUT} is less than 0.2A.
- *3 Input current must be greater than or equal to 10mA if your application applies Maintain Power Signature(MPS) by IEEE802.3af. Please check with your application.

PERFORMANCE DATA, MYBSP00502ABF, MYBSP00502ABFB

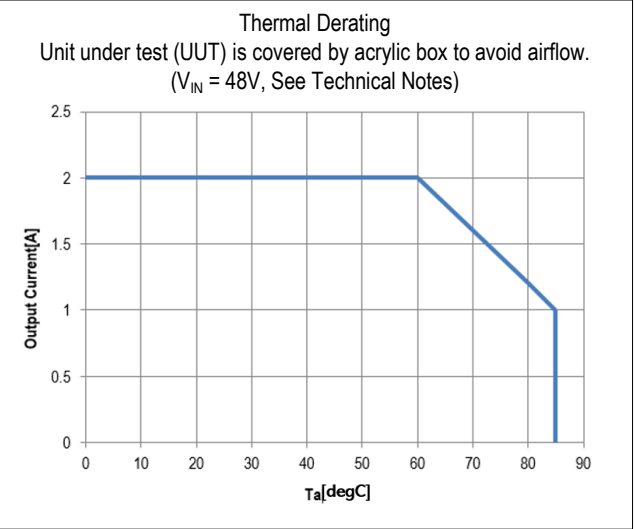
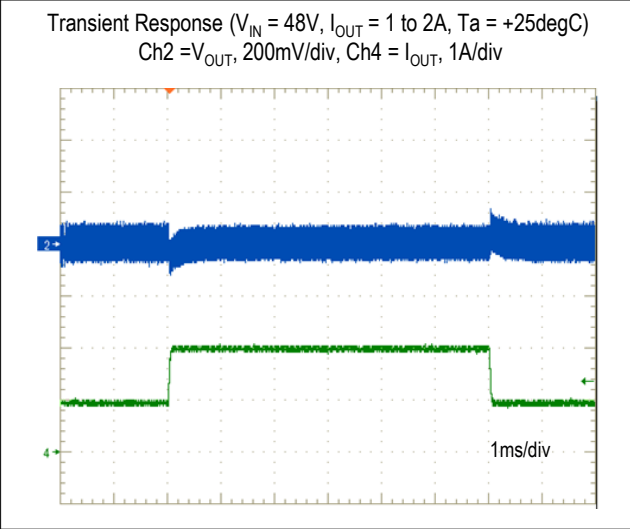
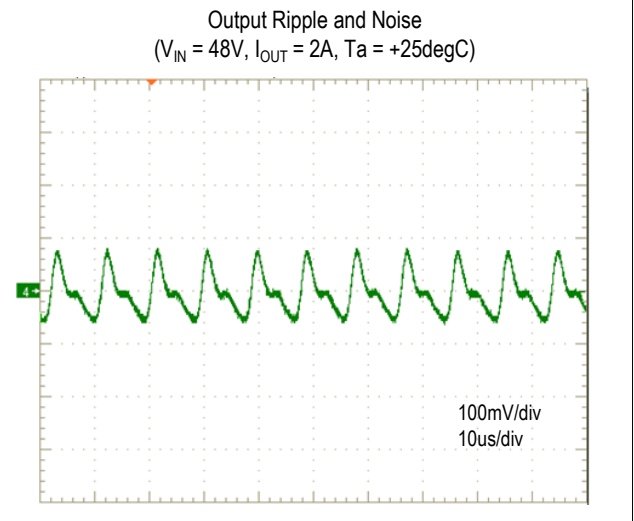
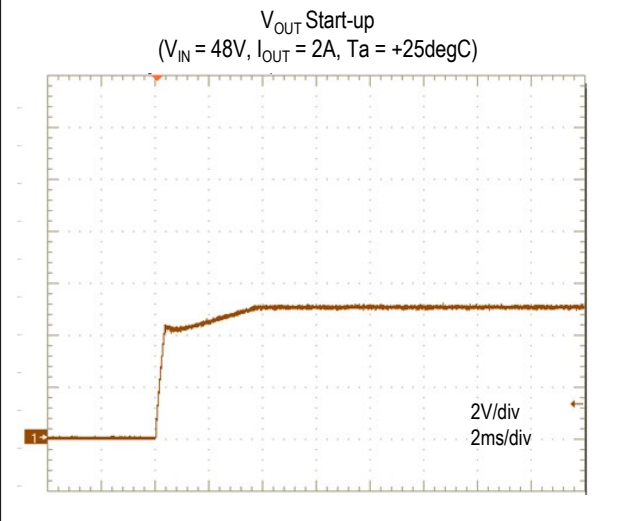
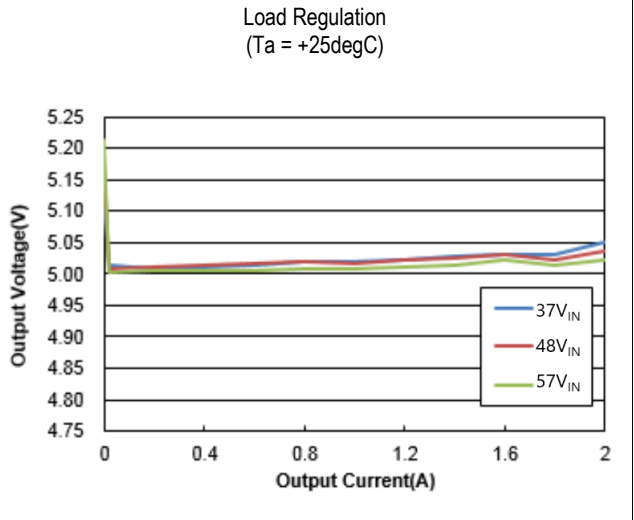
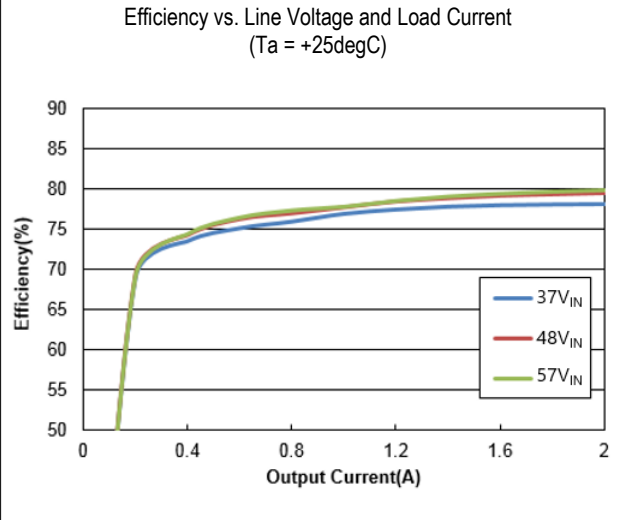

PERFORMANCE DATA, MYBSP00502ABF, MYBSP00502ABFB (CONT.)

Conduction Noise ($V_{IN} = 48V, I_{OUT} = 2A, T_a = +25degC$)
with External Input Filter

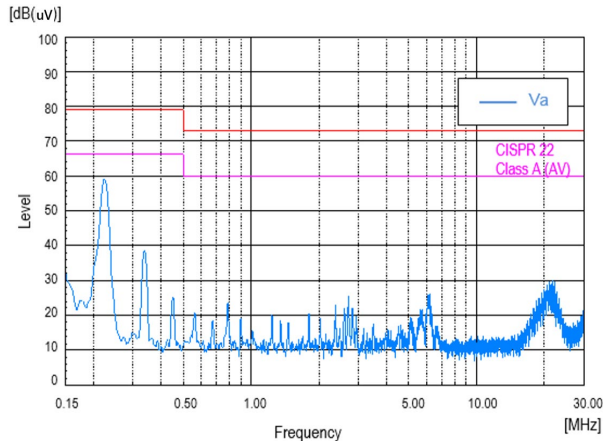

Conduction Noise ($V_{IN} = 48V, I_{OUT} = 2A, T_a = +25degC$)
with External Input Filter

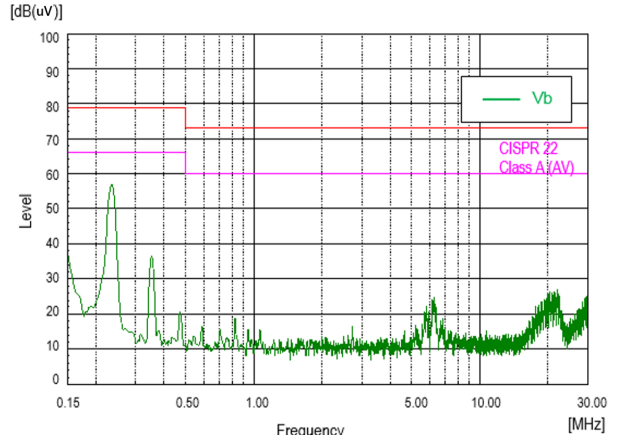

MECHANICAL SPECIFICATIONS

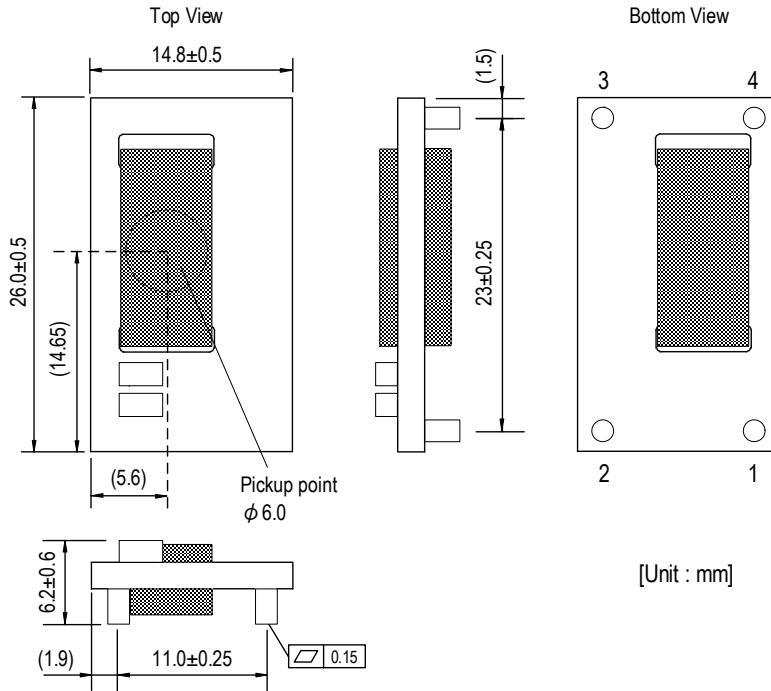

INPUT / OUTPUT CONNECTIONS			
Pin	Designation	Function	Pin size
1	+V _{IN}	Positive Input Voltage	$\phi 1.6$
2	-V _{IN}	Negative Input Voltage	$\phi 1.6$
3	-V _{OUT}	Negative Output Voltage	$\phi 1.6$
4	+V _{OUT}	Positive Output Voltage	$\phi 1.6$

RECOMMENDED FOOTPRINT (Top View)

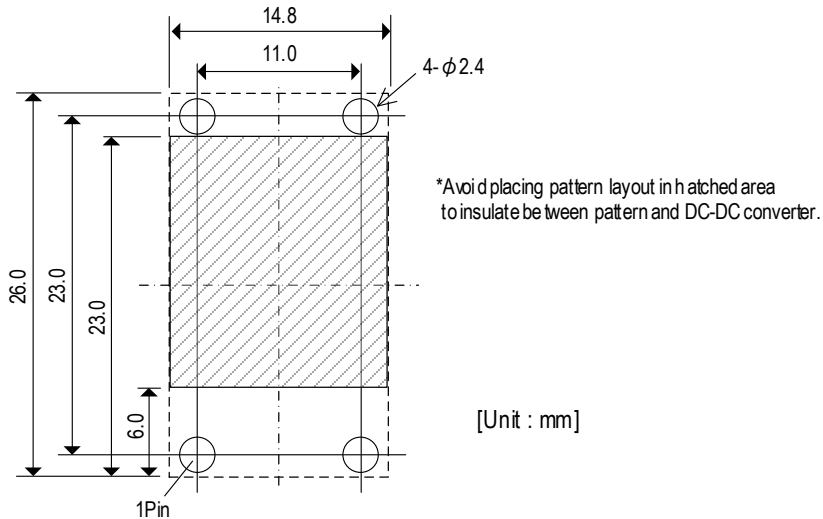

PACKAGING INFORMATION (SURFACE MOUNT, MSL Rating 2 Equivalent)

Packaging form
Tray Specification

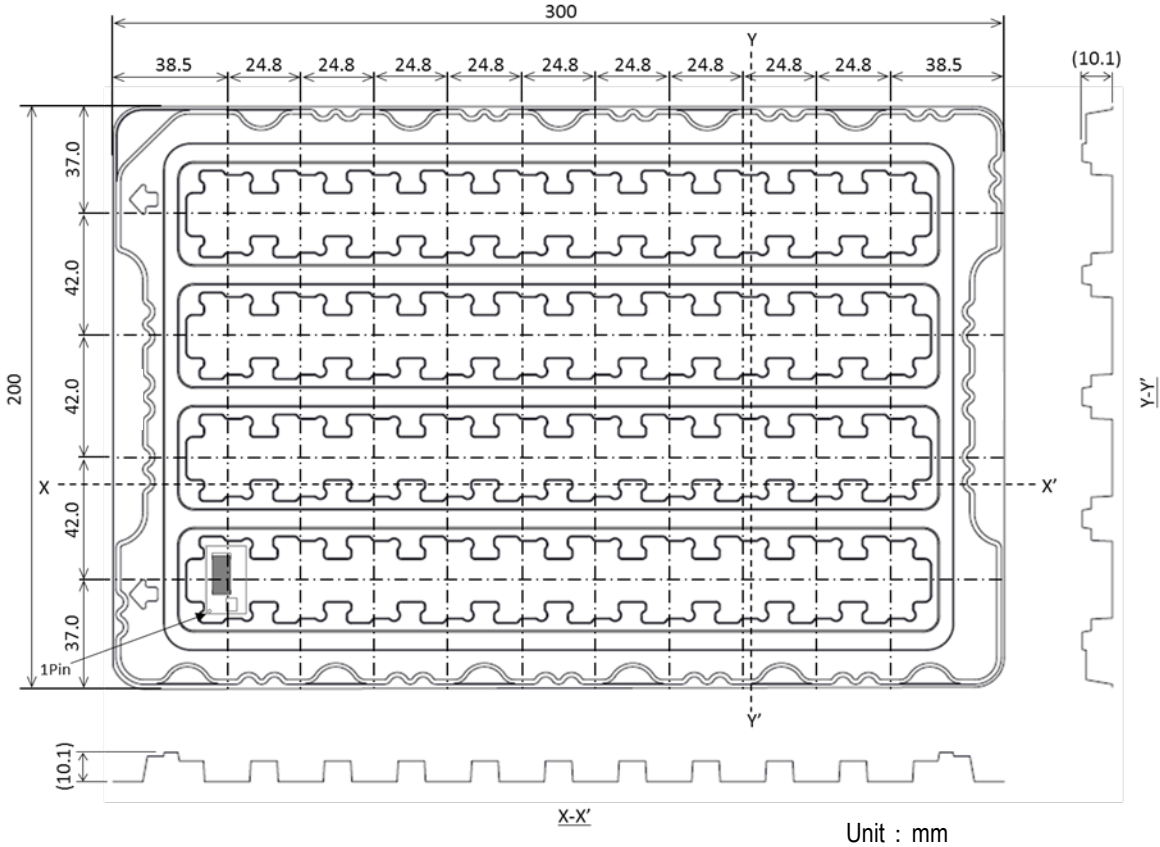

Pieces of contained products per corrugated box.
Maximum contained products pieces 200 pcs/corrugated box.

Further plural sheets of corrugated cardboard are placed on the top of the tray cover according to number of contained trays in order to full up the space in a corrugated box.

PACKAGING INFORMATION (SURFACE MOUNT, MSL Rating 2 Equivalent)

Packaging form
Tray Specification

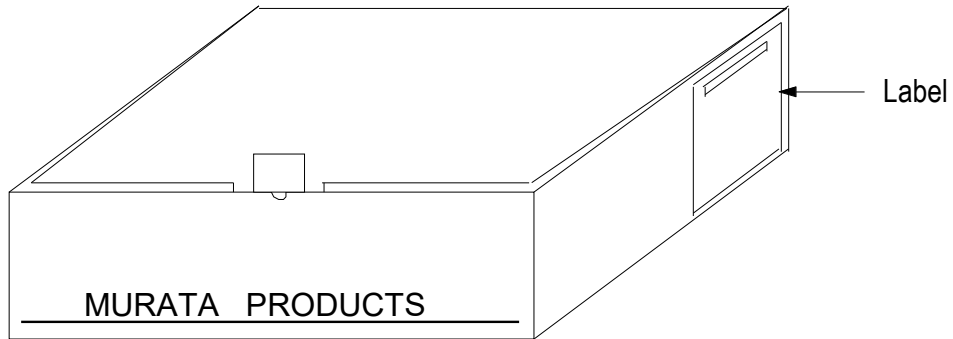
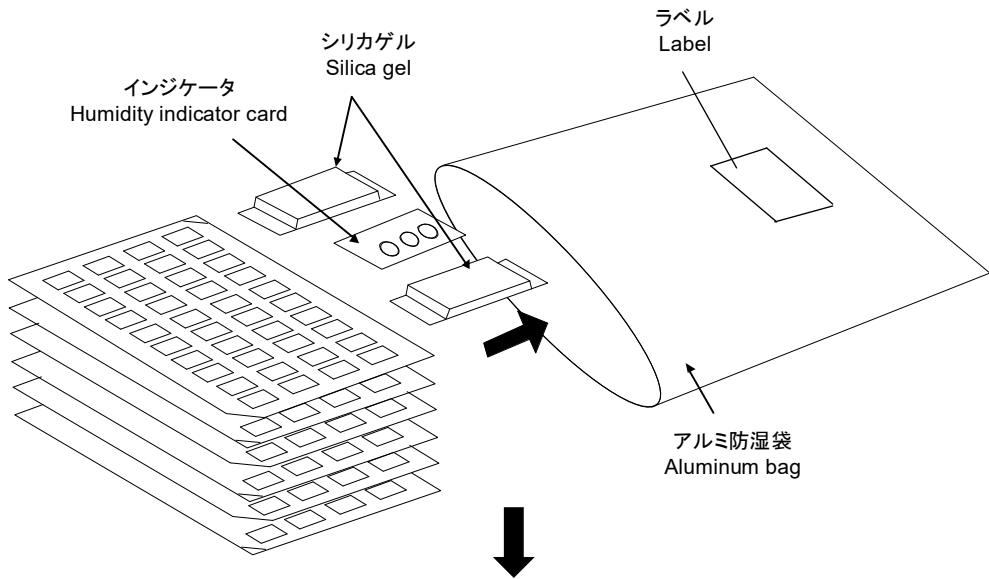
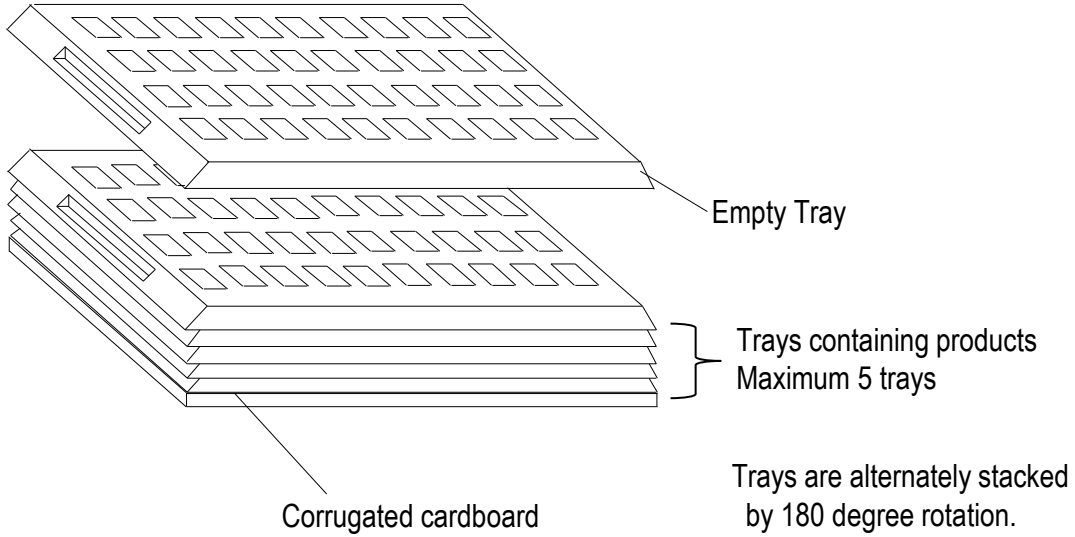

TECHNICAL NOTES

Over Current Protection

Over Current Protection operates with a controller circuit failure or over-load condition. After rejected the abnormal mode, DC-DC converter will automatically restart. However output short voltage affect long-term reliability.

External Input Capacitor

Do not connect any capacitor between positive input and negative input to avoid large inrush current. It is one of the requirements of IEEE802.3af standard.

Test Circuit

The initial values in Functional Specification are measured in the following test circuit.

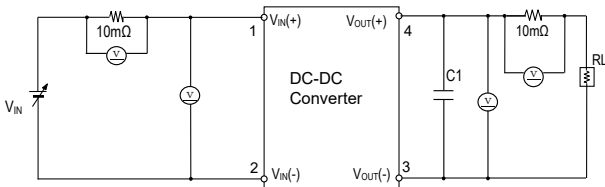

C1 : Ceramic Capacitor 100uF(MYBSP01201ABF, MYBSP01201ABFB)
300uF(MYBSP00502ABF, MYBSP00502ABFB)

RL : Electronic Load Device : LN-1000A-G7 KEISOKU GIKEN equivalent

V_{IN} : DC Power Supply :Model HP6675A KEYSIGHT equivalent

Ⓜ : Digital Multimeter :Model HP34401A KEYSIGHT equivalent

When deviating from the above, DC-DC converter may operate abnormally. It should be fully confirmed on your board before use.

Ripple Noise Test

Output ripple noise is measured using designated external output components, circuits and layout as shown below.

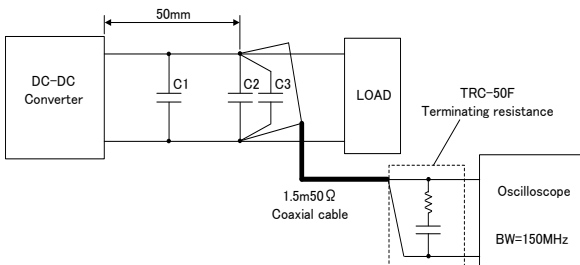

C1 : Ceramic Capacitor 100uF(MYBSP01201ABF, MYBSP01201ABFB)
300uF(MYBSP00502ABF, MYBSP00502ABFB)

C2 : Ceramic Capacitor 0.1uF

C3 : Ceramic Capacitor 10uF

Conduction Noise

The external input filter is installed and the circuit diagram is shown below.

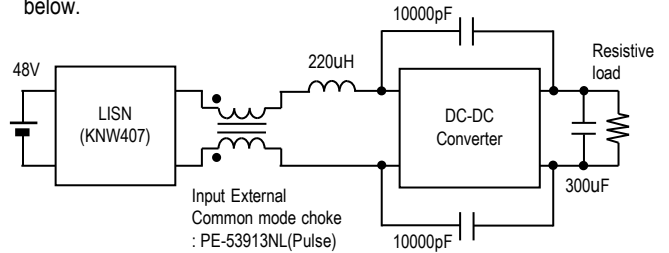

Thermal Derating Condition

The output current is limited by the derating curve. The derating curve in this datasheet illustrate typical operation under a variety of conditions.

DC-DC Converter is tested on a 101.6x188mm, 2 layers Copper evaluation board at V_{IN} = 48V.

The Unit Under Test (UUT) is set up as shown below.

UUT is covered by acrylic box to avoid airflow.

The temperature measurement points are shown below table. The temperature of measurement points should not exceed the maximum temperatures in the below table.

Position	Description	Max temperature
P1	IC	T _{P1MAX} = 110degC
P2	Diode	T _{P2MAX} = 124degC
P3	Transformer pattern	T _{P3MAX} = 125degC

Top View

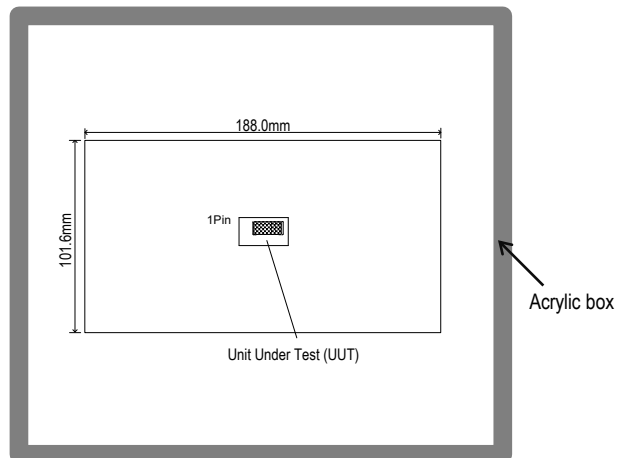
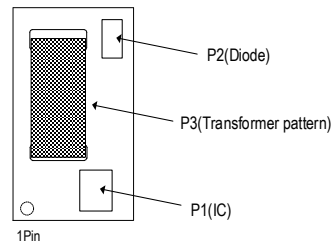

Detection and Hardware Classification

DC-DC converter implements IEEE 802.3af compliant detection and hardware classification.

When DC-DC converter(PD) is connected to PSE, the PSE applies two voltages in the range of 2.8 to 10 V and measures the corresponding current. Connection to PD is detected by measured current.(Detection)

After Detection, the PSE applies voltage in the range of 15.5 to 20.5 V and measures the corresponding current. PD is classified by measured current.(Hardware Classification)

Please check with your application.

SMT Reflow Soldering Guidelines

The surface-mount reflow solder profile is shown below.

This graph should be used only as a guideline.

Reflow Soldering Profiles : JEDEC IPC/JEDEC J-STD-020D

Soldering temperature	245degC +0/-5degC
Soldering time	30 seconds, 240-245degC
Heating time	60~150 seconds, 217degC min.
Preheat time	60~120 seconds, 150-200degC
Programming rate	3degC /sec.max., 217-245degC
Descending rate	6degC /sec.max.
Total soldering time	8 minutes max.,25-245degC
Time	1time

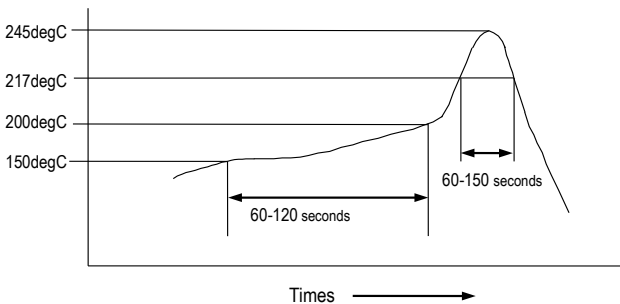

Do not vibrate for the products on reflow. Please need to take care temperature control because mounted parts may come off if the product is left under the high temperature. Do not mount on backside of the board.

Many other factors influence the success of SMT reflow soldering. Since your production environment may differ, please thoroughly review these guidelines with your process engineers.

Storage

Please store this product in an environment where the temperature/humidity is stable in the range 0 to 40 degC /10 to 75%RH and no direct sunlight. Use the product within 6 months after delivery.

Please avoid storage conditions where humidity and temperature change rapidly, as that may cause condensation on the product, which might degrade the quality of the product.

Please do not store the product environments that are dusty, in direct exposure to sea breeze, or in an atmosphere containing corrosive gas (Cl2, NH3, SO2, NOX and so on).

Operational environment and operational conditions

This product is not chemical-proof or rust-proof.

In order to prevent this product from leakage of electricity and/or abnormal temperature increase, do not use the product under the following circumstances:

- (1) in an atmosphere containing corrosive gas (Cl2, NH3, SO2, NOX and so on).
- (2) in a dusty place.
- (3) in a place exposed to direct sunlight.
- (4) in such a place where water splashes or in such a humid place where water condenses.
- (5) in a place exposed to sea breeze.
- (6) in any other places similar to the above (1)through (5).

Operational Conditions

Please use the product within specified values (power supply, temperature, input, output and load condition etc.). Input voltage drops for line impedance, so please make sure that input voltage is within in specified values.

If the product is used over the specified values, it may damage the product, reduce the quality, and even if the products can endure the condition for short time, it may cause degradation of the reliability.

Note Prior to use

If you apply high static electricity, voltage higher than rated voltage or reverse voltage to the product, it may cause defects in the products or degrade the reliability.

Please avoid the following items:

- 1. Over rating power supply, reverse power supply or not-enough connection of input voltage and 0V(DC)line
- 2. Electrostatic discharge by production line and/or operator
- 3. Electrified product by electrostatic induction

Do not subject product to excessive mechanical shock. If you drop the product on the floor it might cause a crack to the core of inductors and monolithic ceramic capacitors.

Also please pay attention to handling; the mounted parts can be dislodged if subjected to excessive force.

Transportation

If you transport the product, please pack it so that the package will not be damaged by mechanical vibration or mechanical shock, and please educate and guide the carrier to prevent rough handling.

Notices**Scope**

This datasheet is applied to MYBSP01201ABF, MYBSP00502ABF, MYBSP01201ABFB and MYBSP00502ABFB. - Specific applications: Consumer Electronics, Industrial Equipment

**Limitation of Applications**

The products listed in the datasheet (hereinafter the product(s) is called the "Product(s)") are designed and manufactured for applications specified in the specification or the datasheet. (hereinafter called the "Specific Application"). We shall not warrant anything in connection with the Products including fitness, performance, adequateness, safety, or quality, in the case of applications listed in from (1) to (11) written at the end of this precautions, which may generally require high performance, function, quality, management of production or safety. Therefore, the Product shall be applied in compliance with the specific application.

We disclaim any loss and damages arising from or in connection with the products including but not limited to the case such loss and damages caused by the unexpected accident, in event that (i) the product is applied for the purpose which is not specified as the specific application for the product, and/or (ii) the product is applied for any following application purposes from (1) to (11) (except that such application purpose is unambiguously specified as specific application for the product in our catalog specification forms, datasheets, or other documents officially issued by us*).

- (1) Aircraft equipment
- (2) Aerospace equipment
- (3) Undersea equipment
- (4) Power plant control equipment
- (5) Medical equipment
- (6) Transportation equipment (such as vehicles, trains, ships)
- (7) Traffic control equipment
- (8) Disaster prevention / crime prevention equipment
- (9) Industrial data-processing equipment
- (10) Combustion/explosion control equipment
- (11) Application of similar complexity and/or reliability requirements to the applications listed in the above

For exploring information of the Products which will be compatible with the particular purpose other than those specified in the datasheet, please contact our sales offices, distribution agents, or trading companies with which you make a deal, or via our web contact form.

Contact form: <https://www.murata.com/contactform>

*We may design and manufacture particular Products for applications listed in (1) to (11). Provided that, in such case we shall unambiguously specify such Specific Application in specification or datasheet without any exception. Therefore, any other documents and/or performances, whether exist or non-exist, shall not be deemed as the evidence to imply that we accept the applications listed in (1) to (11).

Fail-safe function

Be sure to add an appropriate fail-safe function to your finished product to prevent secondary damage in the unlikely event of an abnormality function or malfunction in our product.

Please connect the input terminal by right polarity. If you mistake the connection, it may break the DC-DC converter. In the case of destruction of the DC-DC converter inside, over input current may flow. Please add a diode and fuse as following to protect them.

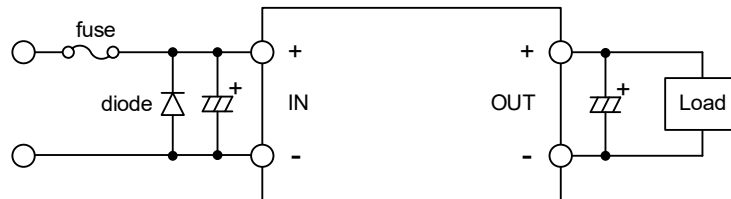

Please select diode and fuse after confirming the operation.

⚠ Note

1. Please make sure that your product has been evaluated in view of your specifications with our product being mounted to your product.
2. You are requested not to use our product deviating from the reference specifications.
3. If you have any concerns about materials other than those listed in the RoHS directive, please contact us.
4. Please don't wash this product under any conditions.

Product Specification

Product Specification in this datasheet are as of April 2025. Specifications and features may change in any manner without notice. Please check with our sales representatives.

Contact form

<https://www.murata.com/contactform?Product=Power%20Device>

Disclaimers

The information described in this data sheet was carefully crafted for accuracy. However this product is based on the assumption that it will be used after thoroughly verifying and confirming the characteristics and system compatibility. Therefore, Murata is not responsible for any damages caused by errors in the description of the datasheet.

Murata constantly strives improve the quality and reliability of our products, but it is inevitable that semiconductor products will fail with a certain probability. Therefore regardless of whether the use conditions are within the range of this data sheet, Murata is not responsible for any damage caused by the failure of this product., (for example, secondary damage, compensation for accidents, punitive damage, loss of opportunity, and etc.) Also, regardless of whether Murata can foresee the events caused by the failure of our product, Murata has no obligations or responsibilities.

The buyer of this product and developer of systems incorporating this product must analyze, evaluate, and make judgements at their own risk in designing applications using this product. The buyer and the developer are responsible for verifying the safety of this product and the applications, and complying with all applicable laws, regulations, and other requirements.

Furthermore, the buyer and developer are responsible for predicting hazards and taking adequate safeguards against potential events at your own risk in order to prevent personal accidents, fire accidents, or other social damage. When using this product, perform thorough evaluation and verification of the safety design designed at your own risk for this product and the application.

Murata assumes that the buyer and developer have the expertise to verify all necessary issues for proper use of the product as described above and to take corrective action. Therefore, Murata has no liability arising out of the use of the product. The buyer and developer should take all necessary evaluations, verifications, corrective actions and etc., in your own responsibility and judgment.

This data sheet does not guarantee or grant any license to the information, including patents, copyrights, and other intellectual property rights, of the Murata or third parties. Regardless of whether the information described in this datasheet is express or implied, Murata does not take any responsibility or liability for any claims, damages, costs, losses, etc. relating to intellectual property rights or other rights from third parties due to the use of these information.

Patent Statement

Murata products are protected to under one or more of the U.S. patents.

Copyright and Trademark

©2025 Murata Manufacturing Co., Ltd. All rights reserved.





This product is subject to the following [operating requirements](#) and the [Life and Safety Critical Application Sales Policy](#):
Refer to: <https://power.murata.com/en/requirements>

Murata Manufacturing Co., Ltd makes no representation that the use of its products in the circuits described herein, or the use of other technical information contained herein, will not infringe upon existing or future patent rights. The descriptions contained herein do not imply the granting of licenses to make, use, or sell equipment constructed in accordance therewith. Spec and cautions are subject to change without notice.

Looking for pricing, stock, or lifecycle information?

Click below to explore more details on WIN SOURCE:

-  [View MYBSP00502ABF on WIN SOURCE](#)
-  [Murata Power Solutions Inc. Information](#)

Optimize Your Supply Chain with WIN SOURCE Solutions

-  Global Sourcing Solution
-  Obsolete Management
-  Cost Control Management
-  Shortage Management
-  Alternative Solution
-  Excess Inventory Management