

High-Accuracy, Pulse-Width or AK Protocol Hall-Effect Wheel Speed and Direction Sensor IC

FEATURES AND BENEFITS

- **Hall-effect technology** allows ease of use for ring magnet and ferromagnetic target sensing
- **PW and AK Protocol** provides speed and direction information, signal integrity, and functional status
- **Integrated capacitor** in a single overmolded miniature package provides greater EMC robustness
- **SolidSpeed Digital Architecture** supports advanced algorithms, maintaining pitch accuracy during dynamic air gap disturbances
- **ASIL-Compliant:** ASIL B safety element out-of-context (SEooC) developed in accordance with ISO 26262, when used as specified in the safety manual
- **EEPROM** enables traceability throughout the product life cycle



PACKAGE:

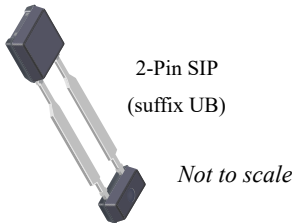

DESCRIPTION

The A19302 is an optimized Hall-effect integrated circuit (IC) with the option for PW- or AK-protocol two-wire interface, ideal for applications requiring the determination of speed and direction of the sensed target. The small package includes an integrated capacitor and Hall-based IC in a single overmolded design, with an additional molded lead-stabilizing bar for robust shipping and ease of assembly.

The IC's SolidSpeed Digital Architecture provides highly accurate speed and rotational direction detection. The intelligent algorithms provide signal optimization and compensation capable of maintaining stable operation in the harsh automotive environments common to wheel speed applications.

The A19302 was developed in accordance with ISO 26262 as a hardware safety element out-of-context with ASIL B capability for use in automotive safety-related systems when integrated and used in the manner prescribed in the applicable safety manual and datasheet.

Integrated EEPROM memory allows traceability of the device throughout the product lifecycle.

The IC is offered in the UB package, which integrates the IC and a high temperature ceramic capacitor in a single overmolded SIP package for enhanced EMC performance.

The 2-pin SIP package is lead (Pb) free, with tin leadframe plating.

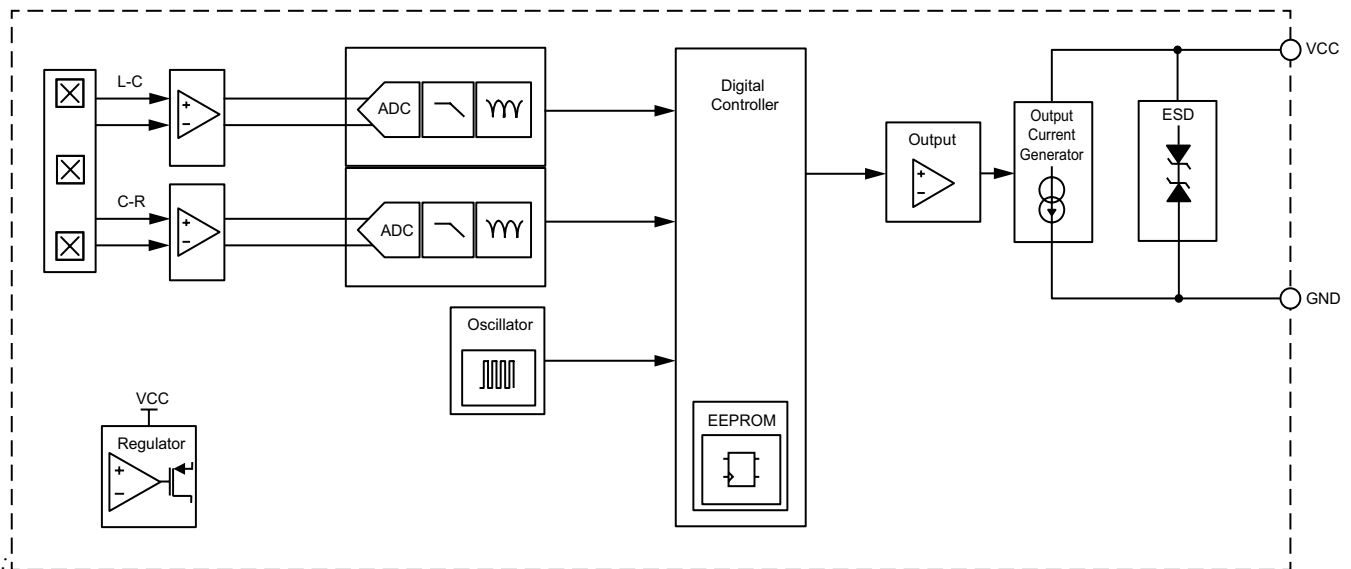

Figure 1: Functional block diagram

A19302

High-Accuracy, Pulse-Width or AK Protocol Hall-Effect Wheel Speed and Direction Sensor IC

SELECTION GUIDE [1]

Part Number	Packing
A19302PUBATN-FAE	Tape and reel, 4000 pieces per reel
A19302PUBATN-RAE	
A19302PUBATN-FPE	
A19302PUBATN-RPE	
A19302PUBATN-FAE-A	Tape and reel, 4000 pieces per reel
A19302PUBATN-RAE-A	
A19302PUBATN-FPE-A	
A19302PUBATN-RPE-A	



[1] Not all combinations are available. Contact Allegro sales for availability and pricing of custom programming options.

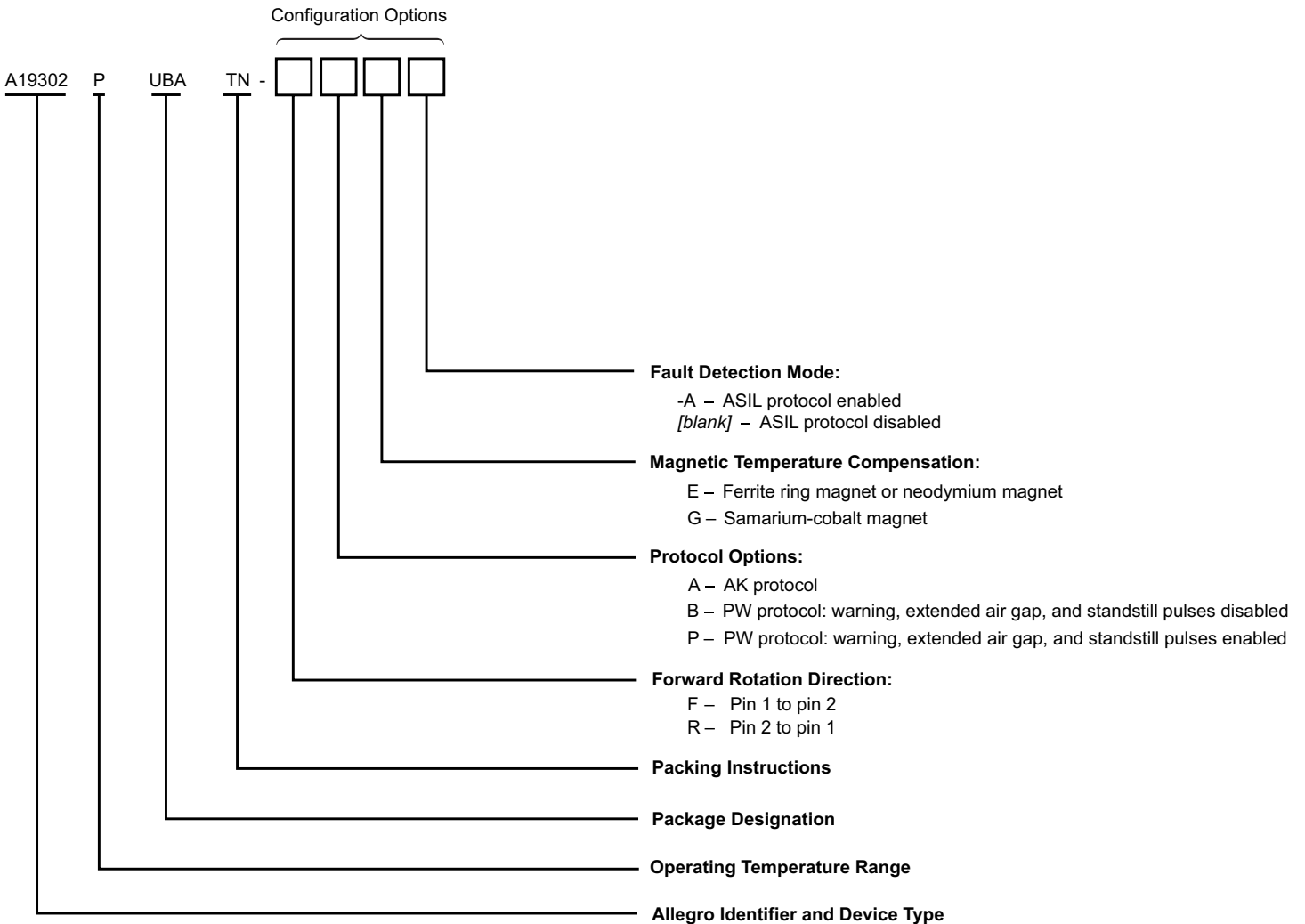

SPECIFICATIONS

ABSOLUTE MAXIMUM RATINGS

Characteristic	Symbol	Notes	Rating	Unit
Supply Voltage	V_{CC}	Refer to Power Derating section; potential between pin 1 and pin 2	28	V
Reverse Supply Voltage	V_{RCC}		-18	V
Operating Ambient Temperature	T_A		-40 to 160	°C
Junction Temperature	$T_{J(max)}$		175	°C
Storage Temperature	T_{stg}		-65 to 170	°C

INTERNAL DISCRETE CAPACITOR RATINGS

Characteristic	Symbol	Test Conditions	Value (Typ.)	Unit
Nominal Capacitance	C_{SUPPLY}	Connected between pin 1 and pin 2 (refer to Figure 2)	2.2	nF

PINOUT DIAGRAM

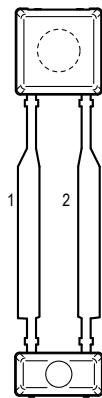

UB Package,
2-Pin SIP Pinout Diagram

PINOUT TABLE

Name	Number	Function
VCC	1	Supply Voltage
GND	2	Ground

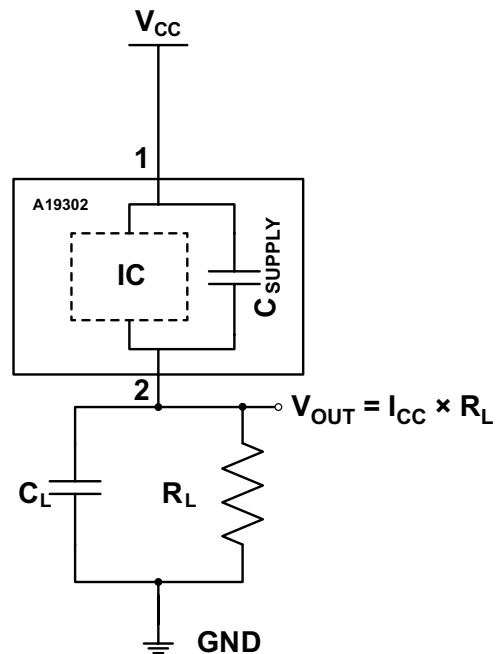

Figure 2: Typical Application Circuit

OPERATING CHARACTERISTICS: Valid over operating voltage and temperature, unless otherwise specified

Characteristic	Symbol	Test Conditions	Min.	Typ. ^[1]	Max.	Unit	
ELECTRICAL SUPPLY CHARACTERISTICS							
Supply Voltage ^[2]	V_{CC}	Potential between pin 1 and pin 2	-xBx and -xPx variants	4	–	24	V
			-xAx variant	5.2	–	24	V
UVLO Hysteresis	$V_{HYS(AK)}$	-xAx variant	1.1	–	–	V	
Reverse Supply Current ^[3]	I_{RCC}	$V_{CC} = V_{RCC(max)}$	–10	–	–	mA	
Supply Zener Clamp Voltage	$V_{Zsupply}$	$I_{CC} = 36.6$ mA	28	–	–	V	
Supply Current	$I_{CC(LOW)}$	Low-current state	5.9	7	8.4	mA	
	$I_{CC(MID)}$	Mid-current state	12	14	16	mA	
	$I_{CC(HIGH)}$	High-current state	23.52	28.0	33.6	mA	
Supply Current Ratio ^[4]	$I_{CC(MID)} / I_{CC(LOW)}$	Measured as ratio of mid current to low current (isothermal)	1.9	–	–	–	
	$I_{CC(HIGH)} / I_{CC(LOW)}$	Measured as ratio of high current to low current (isothermal)	3.6	–	–	–	
ASIL Safety Current	I_{FAULT}	Refer to Figure 14	1.5	3.5	3.9	mA	
Output Rise/Fall Time	t_r, t_f	Voltage measured at pin 2 in Figure 2; $R_L = 100 \Omega$, $C_L = 10$ pF, measured between 10% and 90% of $I_{CC(LOW)}$ and $I_{CC(MID)}$ (-xBx and -xPx variants)	0	–	1.5	μ s	
Slew Rate	SR	Measured at pin 2 in Figure 2; $R_L = 50 \Omega$, $C_L = 10$ pF, measured between 10% and 90% of $I_{CC(LOW)}$ and $I_{CC(HIGH)}$ or $I_{CC(LOW)}$ and $I_{CC(MID)}$ (-xAx variant)	8	–	28	mA/ μ s	
Overtemperature Threshold	T_{JF}	Junction temperature that sets AK OT bit (-xAx variant)	–	175	–	$^{\circ}$ C	
Overtemperature Hysteresis	T_{JHYS}	Junction overtemperature threshold hysteresis (-xAx variant)	–	15	–	$^{\circ}$ C	
POWER-ON CHARACTERISTICS							
Power-On State	POS	$V_{CC} > V_{CC(min)}$, as connected in Figure 2		$I_{CC(LOW)}$		mA	
Power-On Time ^[5]	t_{PO}	$V_{CC} > V_{CC(min)}$, as connected in Figure 2	–	0.25	1	ms	
OPERATING CHARACTERISTICS AND PERFORMANCE							
Operating Differential Magnetic Input ^[6]	$B_{DIFF(pk-pk)}$	Peak-to-peak of differential magnetic input ($T_A = 160^{\circ}$ C)	20	–	–	G	
Operating Differential Magnetic Range ^[6]	B_{DIFF}	Refer to Figure 6	–700	–	700	G	
Operating Magnetic Input Signal Variation	$\Delta B_{DIFF(pk-pk)}$	Bounded amplitude ratio within T_{WINDOW} ^[7] ; no missed output transitions or flat line condition; possible incorrect direction information; see Figure 4 and Figure 5	0.4	–	–	–	
Operating Magnetic Input Signal Window	T_{WINDOW}	Rolling window where $\Delta B_{DIFF(pk-pk)}$ cannot exceed bounded ratio; see Figure 4 and Figure 5	4	–	–	T_{CYCLE}	
Calibration Period	T_{CAL}	Period between power-on and valid speed and correct direction output ($f \leq 200$ Hz)	–	–	1.5	T_{CYCLE}	
Operate Point	B_{OP}	% of peak-to-peak IC-processed signal	–	60	–	%	
Release Point	B_{RP}	% of peak-to-peak IC-processed signal	–	40	–	%	
Switch Point Separation	$B_{DIFF(SP-SEP)}$	Required amount of amplitude separation between channel A and channel B at each B_{OP} and B_{RP} occurrence. Channels must be in phase; see Figure 7	20	–	–	%	

Continued on next page...

OPERATING CHARACTERISTICS (continued): Valid over operating voltage and temperature, unless otherwise specified

Characteristic	Symbol	Test Conditions	Min.	Typ. ^[1]	Max.	Unit
OUTPUT PROTOCOL CHARACTERISTICS [8] (-xAx variant)						
Bit Width	t_p	Refer to Figure 9	40	50	60	μs
Standstill Period	t_{STOP}		105	150	195	ms
AK Off Time	$t_{\text{W(PRE)}}$	Pre-low time	–	75	–	μs
Pulse Width, ASIL Fault	$t_{\text{W(FAULT)}}$	Refer to Figure 14	5	–	–	ms
Air Gap Reserve Level	B_{LR}	Signal amplitude that engages AK LR bit	–	24	–	$G_{\text{pk-pk}}$
Operating Frequency	f_{SIG}		0	–	2.5	kHz
OUTPUT PROTOCOL CHARACTERISTICS [8] (-xBx variant)						
Pulse Width Off Time	$t_{\text{W(PRE)}}$	Refer to Figure 9	38	45	52	μs
Forward Pulse Width	$t_{\text{W(FWD)}}$		76	90	104	μs
Reverse Pulse Width	$t_{\text{W(REV)}}$		153	180	207	μs
Pulse Width, ASIL Fault	$t_{\text{W(FAULT)}}$	Refer to Figure 14	5	–	–	ms
Operating Frequency, Forward Pulses [9]	f_{FWD}		0	–	3.9	kHz
Operating Frequency, Reverse Pulses [9]	f_{REV}		0	–	2.4	kHz
OUTPUT PROTOCOL CHARACTERISTICS [8] (-xPx variant)						
Pulse Width Off Time	$t_{\text{W(PRE)}}$	Refer to Figure 9	38	45	52	μs
Forward Pulse Width	$t_{\text{W(FWD)}}$		76	90	104	μs
Reverse Pulse Width	$t_{\text{W(REV)}}$		153	180	207	μs
EA Forward Pulse Width	$t_{\text{W(EA FWD)}}$		306	360	414	μs
EA Reverse Pulse Width	$t_{\text{W(EA REV)}}$		612	720	828	μs
Warning Pulse Width	$t_{\text{W(WARN)}}$		38	45	52	μs
Standstill Pulse Width	$t_{\text{W(STILL)}}$		1232	1440	1656	μs
Standstill Period	t_{STOP}		590	737	848	ms
Pulse Width, ASIL Fault	$t_{\text{W(FAULT)}}$	Refer to Figure 14	5	–	–	ms
Operating Frequency, Forward Pulses [9]	f_{FWD}		0	–	3.9	kHz
Operating Frequency, Reverse Pulses [9]	f_{REV}		0	–	2.4	kHz
Operating Frequency, Warning Pulses	f_{WARN}		0	–	5	kHz
Operating Frequency, EA Pulses	f_{EA}	EA pulses output when $f < f_{\text{EA}}$ and $B_{\text{DIFF(pk-pk)}} < B_{\text{EA}}$	–	117	–	Hz
Air Gap Warning Level	B_{WARN}	Warning pulses output when $B_{\text{DIFF(pk-pk)}} < B_{\text{WARN}}$	–	24	–	$G_{\text{pk-pk}}$
Extended Air Gap Level	B_{EA}	EA pulses output when $f < f_{\text{EA}}$ and $B_{\text{DIFF(pk-pk)}} < B_{\text{EA}}$	–	84	–	$G_{\text{pk-pk}}$

Continued on next page...

OPERATING CHARACTERISTICS (continued): Valid over operating voltage and temperature, unless otherwise specified

Characteristic	Symbol	Test Conditions	Min.	Typ. ^[1]	Max.	Unit
THERMAL CHARACTERISTICS						
Magnetic Temperature Coefficient ^[10]	TC	Based on ferrite ring magnet and neodymium magnet (-xxE variant)	–	0.16	–	%/°C
		Based on samarium-cobalt magnet (-xxG variant)	–	0.04	–	%/°C
Package Thermal Resistance ^[11]	R _{θJA}	Single-layer PCB with copper limited to solder pads	–	213	–	°C/W

^[1] Typical values are at T_A = 25°C and V_{CC} = 12 V. Performance may vary for individual units, within the specified maximum and minimum limits.

^[2] Maximum voltage must be adjusted for power dissipation and junction temperature; refer to Power Derating section.

^[3] Negative current is defined as conventional current coming out of (sourced from) the specified device terminal.

^[4] Supply current ratio is taken as a mean value of I_{CC(MID)} / I_{CC(LOW)} and I_{CC(HIGH)} / I_{CC(LOW)}.

^[5] Output transients prior to t_{PO} should be ignored.

^[6] Differential magnetic field is measured for Channel A (E1-E2) and Channel B (E2-E3) independently. Each channel's differential magnetic field is measured between two Hall elements. Magnetic field is measured orthogonally to the front of the package. B_{DIFF(pk-pk)} only valid at T_{A(max)} due to magnetic temperature compensation. Refer to UB package drawing.

^[7] Symmetrical signal variation is defined as the largest amplitude ratio from B_n to B_n + T_{WINDOW}. Signal variation may occur continuously while B_{DIFF} remains in the operating magnetic range.

^[8] Pulse width measured at threshold of (I_{CC(MID)} + I_{CC(LOW)}) / 2 and (I_{CC(HIGH)} + I_{CC(LOW)}) / 2.

^[9] These frequency ranges are based on valid pulse width generation with each pulse width preceding with a t_{w(PRE)(MAX)}. Frequency is based on B_{DIFF} frequency.

^[10] Magnets decrease in strength with increasing temperature. The device temperature coefficient compensates to help maintain a consistent maximum air gap over temperature.

^[11] Additional thermal information is available on the Allegro website.

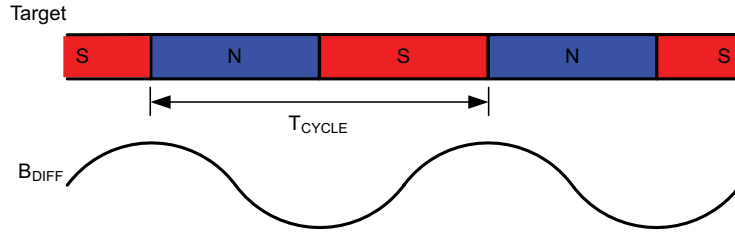

T_{CYCLE} = Target Cycle; the amount of rotation that moves one north and one south pole across the sensor

B_{DIFF} = The differential magnetic flux density sensed by the sensor

Figure 3: Definition of T_{CYCLE}

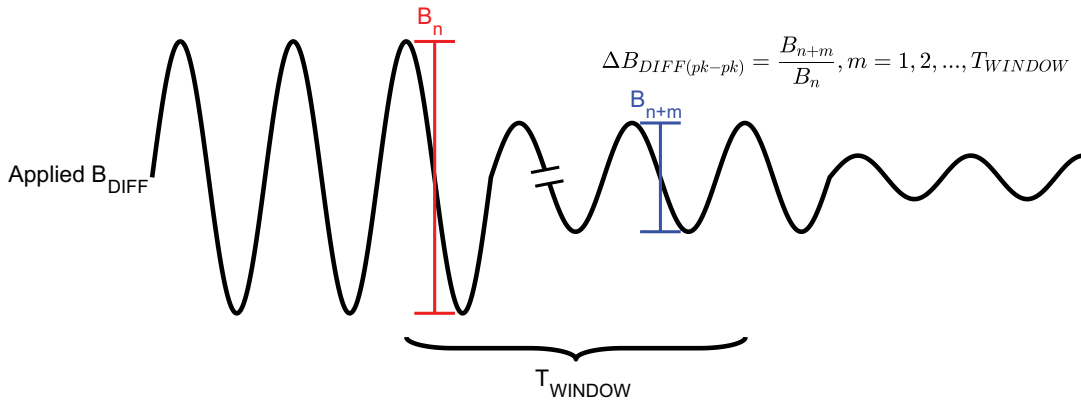

Figure 4: Single Period-to-Period Variation

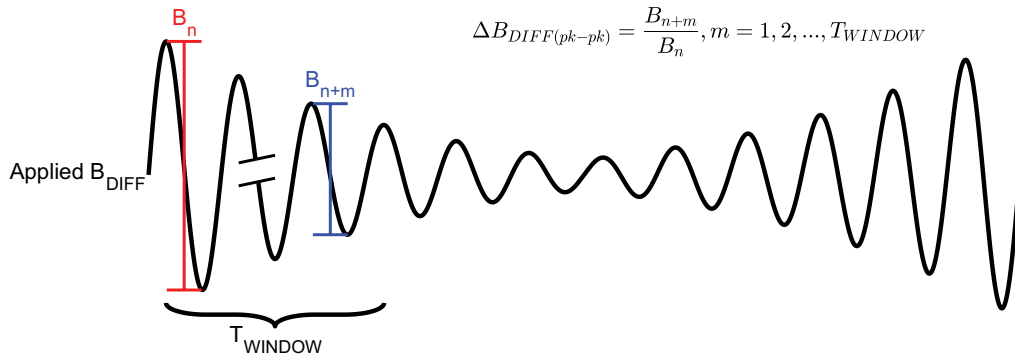

Figure 5: Repeated Period-to-Period Variation

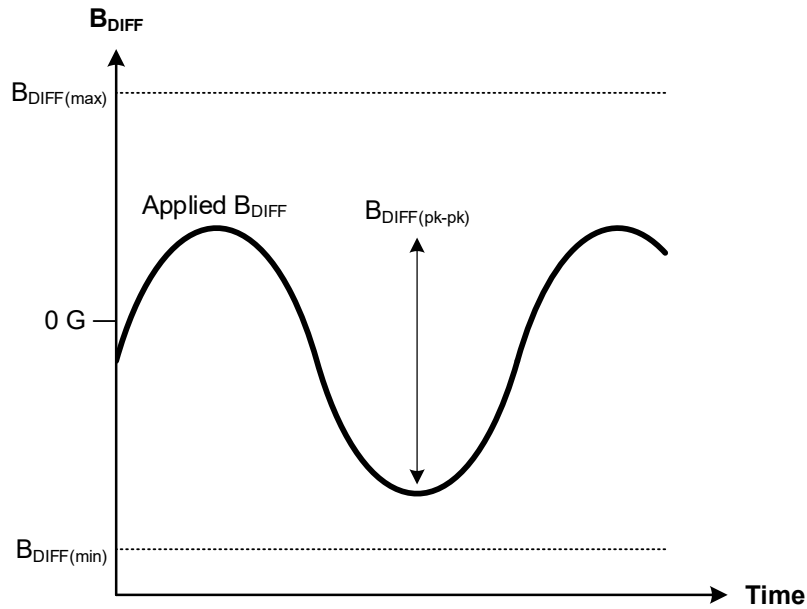

Figure 6: Definition of Differential Magnetic Input

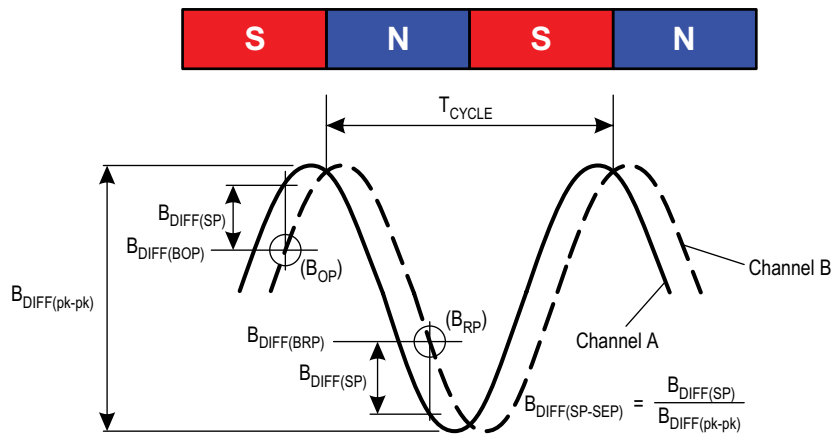

Figure 7: Definition of Switch Point Separation

FUNCTIONAL DESCRIPTION

The A19302 sensor IC contains a single-chip Hall-effect circuit that supports three Hall elements. These elements are used in differential pairs to provide electrical signals containing information regarding edge position and direction of target rotation. The A19302 is intended for use with ring magnet targets, or, when back-biased with an appropriate magnet, with ferromagnetic targets. The IC detects the peaks of the magnetic signals and sets dynamic thresholds based on these detected signals. Output events are triggered when B_{DIFF} transitions through the switch points.

FORWARD ROTATION

For the -Fxx variant, when the target is rotating such that a target feature passes from pin 1 to pin 2, this is referred to as forward rotation. This direction of rotation is indicated on the output by the AK or PW protocol. For the -Rxx variant, forward direction is indicated for target rotation from pin 2 to 1 (refer to Figure 8).

REVERSE ROTATION

For the -Fxx variant, when the target is rotating such that a target feature passes from pin 2 to pin 1, this is referred to as reverse rotation. This direction of rotation is indicated on the output by the AK or PW protocol. For the -Rxx variant, reverse direction is indicated for target rotation from pin 1 to 2.

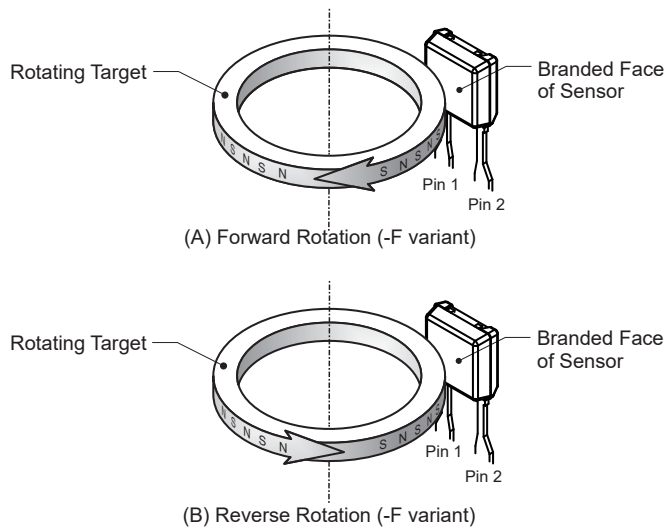

Figure 8: Target Orientation Relative to Device (ring magnet shown).

AK PROTOCOL DESCRIPTION

When a target passes in front of the device (opposite the branded face of the package case), the A19302 generates an AK word for each magnetic pole or for each tooth and each valley of the target. Speed information is provided by the output pulse rate, while direction of target rotation is provided in the AK data bits.

PW PROTOCOL DESCRIPTION

When a target passes in front of the device (opposite the branded face of the package case), the A19302 generates an output pulse for each magnetic pole or for each tooth and each valley of the target. Speed information is provided by the output pulse rate, while direction of target rotation is provided by the duration of the output pulses.

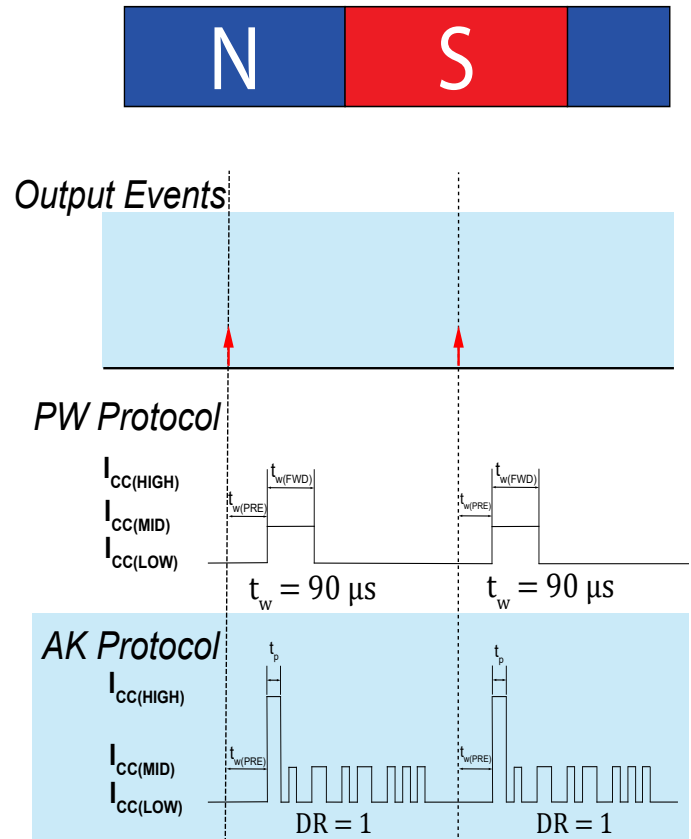

Figure 9: Output Timing Example

DESCRIPTION OF AK PROTOCOL

The A19302 will fulfill the requirements according to the AK protocol specification “Requirement Specifications for Standardized Interface for Wheel Speed Sensors with Additional Information ‘AK-Protokoll’” version 4.0 with some modifications as discussed in the following.

AK BIT DEFINITIONS

The AK protocol (-xAx variant) consists of 10 pulses. A single speed pulse, 8 data bits, and a single parity bit. The speed pulse and data bit definitions are described below.

Field	Abbreviation	Coding
Speed Pulse	SP	$I_{CC(HIGH)}$ if speed pulse, $I_{CC(MID)}$ if standstill pulse

Bit Number	Field	Abbreviation	Coding	Post-Power-On Default Value
0	Air Gap Reserve	LR	1 if $G_{pkpk} < B_{LR(pk-pk)}$, 0 otherwise	0
1	Status Mode	M	1 if not in running mode, 0 otherwise	1
2	Overtemperature	OT	1 if overtemperature, 0 otherwise	0
3	Validity of the Direction of Rotation	GDR	1 if direction is valid, 0 otherwise	0
4	Direction	DR	1 if forward rotation, 0 if reverse rotation	0
5	Air Gap Indication	LM0	LM LSB	0
6	Air Gap Indication	LM1	LM	0
7	Air Gap Indication	LM2	LM MSB	0
8	Parity	P	1 if parity incl. parity bit is even, 0 otherwise	1

LM AIR GAP TABLE

Data bits [5:7] report the air gap indication. These bits give 8 air gap ranges in respect to the measured peak to peak magnetic field ($B_{DIFF(pk-pk)}$).

LM2	LM1	LM0	Threshold Value (Typ.)	Units
0	0	0	≤ 12	G
0	0	1	> 12	G
0	1	0	> 18	G
0	1	1	> 24	G
1	0	0	> 36	G
1	0	1	> 54	G
1	1	0	> 78	G
1	1	1	> 111	G

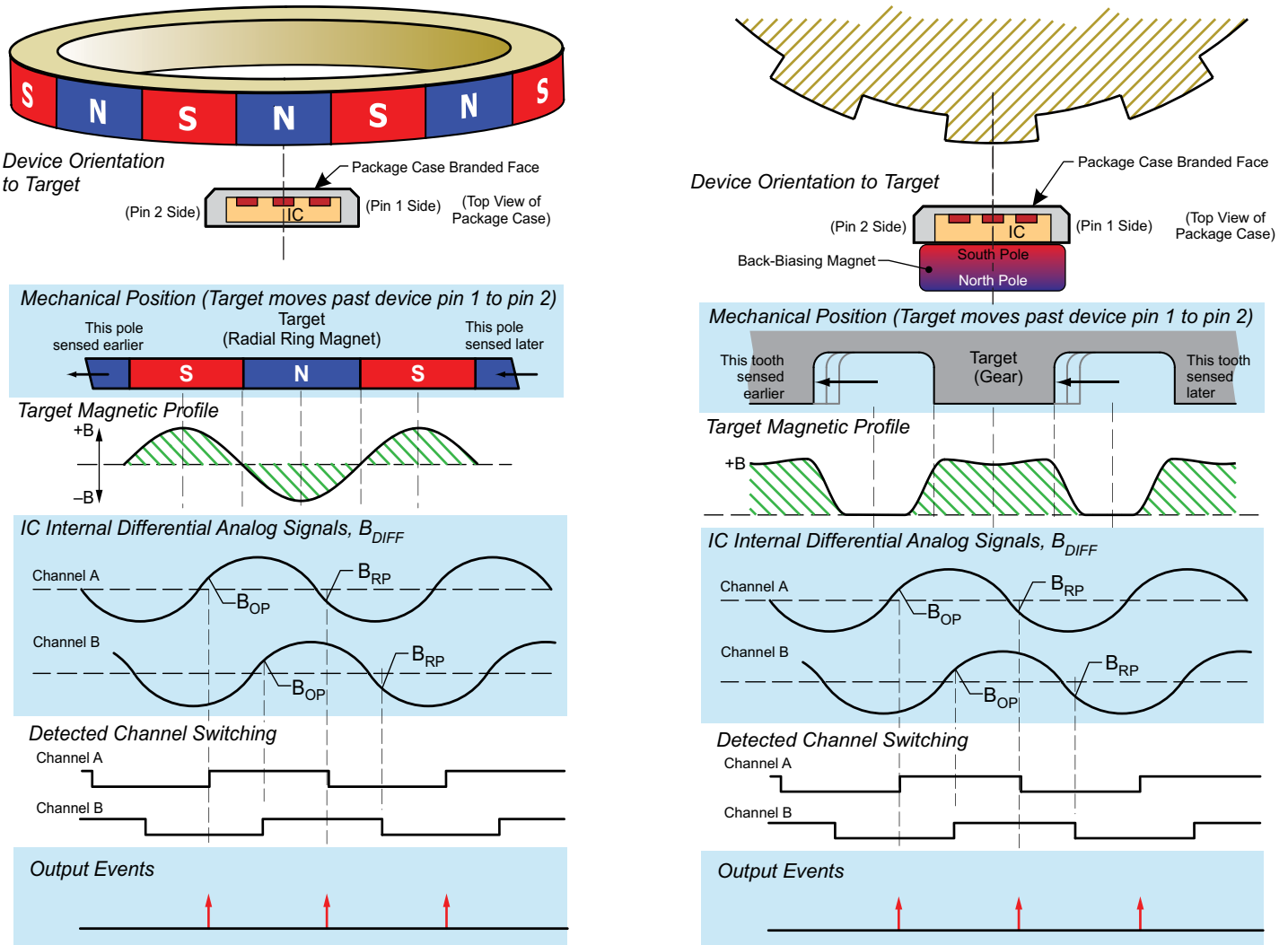

Figure 10: Basic operation

Channel A or Channel B can be used as the output switching channel. This is determined on startup by the first channel that switches. The non-switching channel is used for direction detection.

Calibration and Direction Validation

When power is applied to the A19302, the built-in algorithm performs an initialization routine. For a short period after power-on, the device calibrates itself and determines the direction of target rotation. Once the calibration routine is complete, the A19302 will transmit accurate speed and direction information.

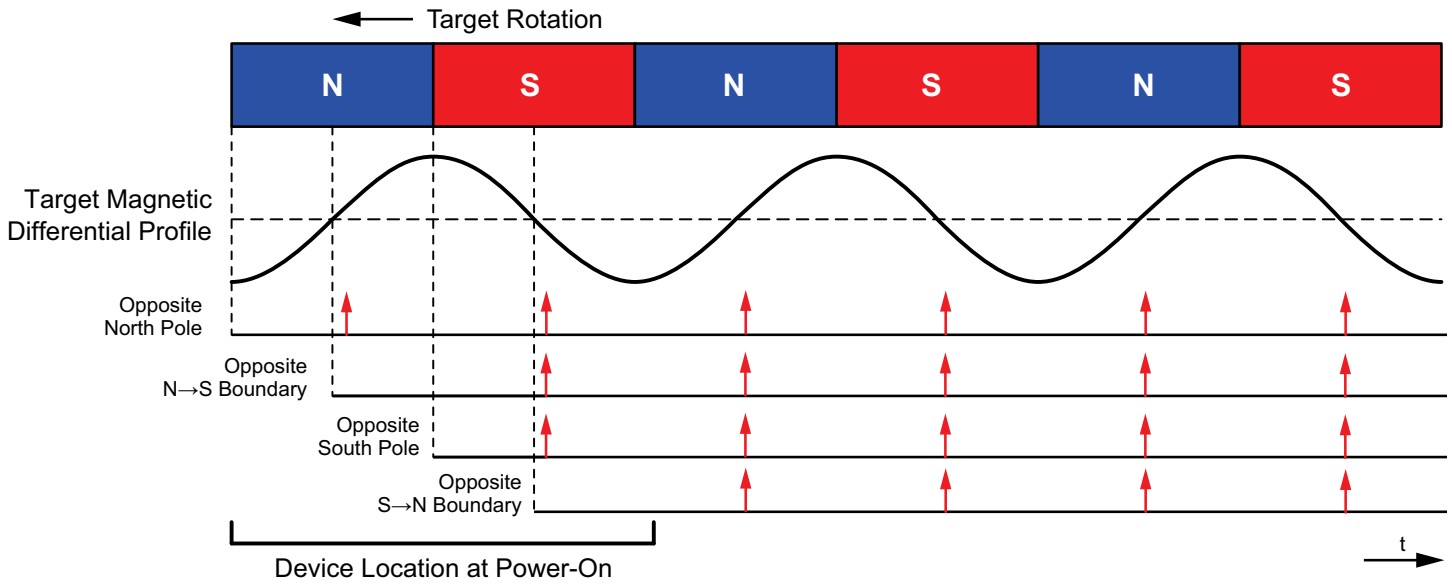

Figure 11: Calibration Behavior (-xBx Variant)

Direction Changes, Vibrations, and Anomalous Events

During normal operation, the A19302 will be exposed to changes in the direction of target rotation (Figure 12), vibrations of the target (Figure 13), and anomalous events such as sudden air gap changes.

During calibration, output pulses with direction information are immediately transmitted to the output. Depending on target design, air gap, and the phase of the target, direction may be momentarily incorrect. Following a direction change in running mode, direction changes are immediately transmitted to the output.

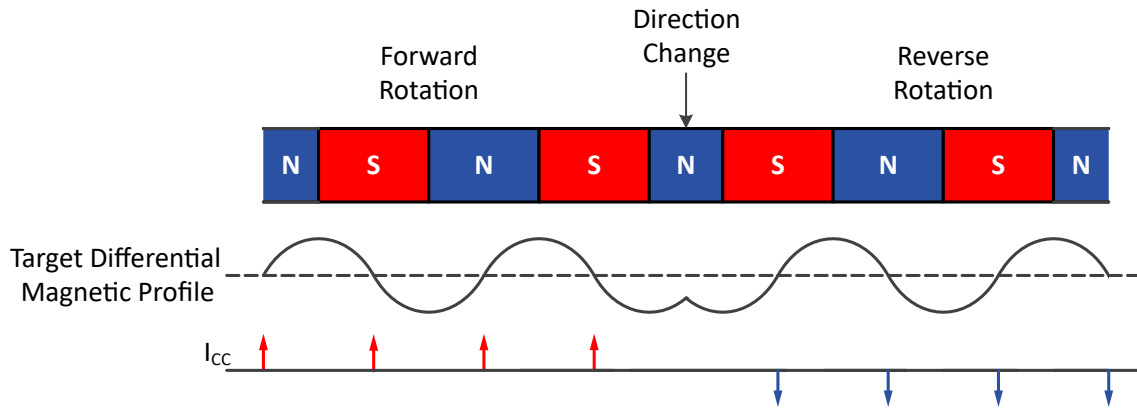

Figure 12: Direction Change Behavior

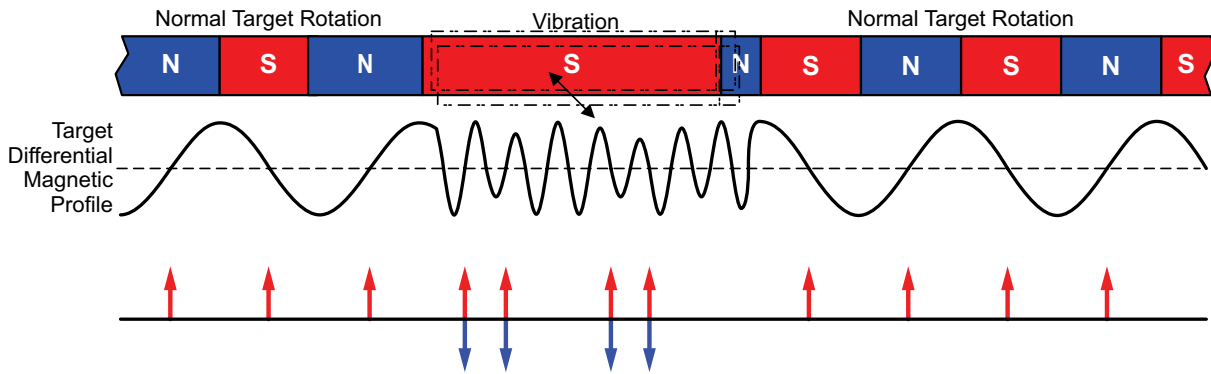

Figure 13: Vibration Behavior

ASIL Safe State Output Protocol

The A19302 was developed in accordance with ISO 26262 as a hardware safety element out-of-context with ASIL B capability for use in automotive safety-related systems when integrated and used in the manner prescribed in the applicable safety manual and datasheet.

The -xxx-A variant enables diagnostic circuitry that will continuously monitor occurrences of failure defects within the IC. Refer to Figure 14 for the output protocol of the ASIL safe state after an internal defect has been detected. Error Protocol will result from faults which cause incorrect signal transmission (i.e., too few or too many output pulses).

Note: If a fault exists continuously, the device will stay in permanent safe state. Refer to the A19302 Safety Manual for additional details on the ASIL Safe State Output Protocol.

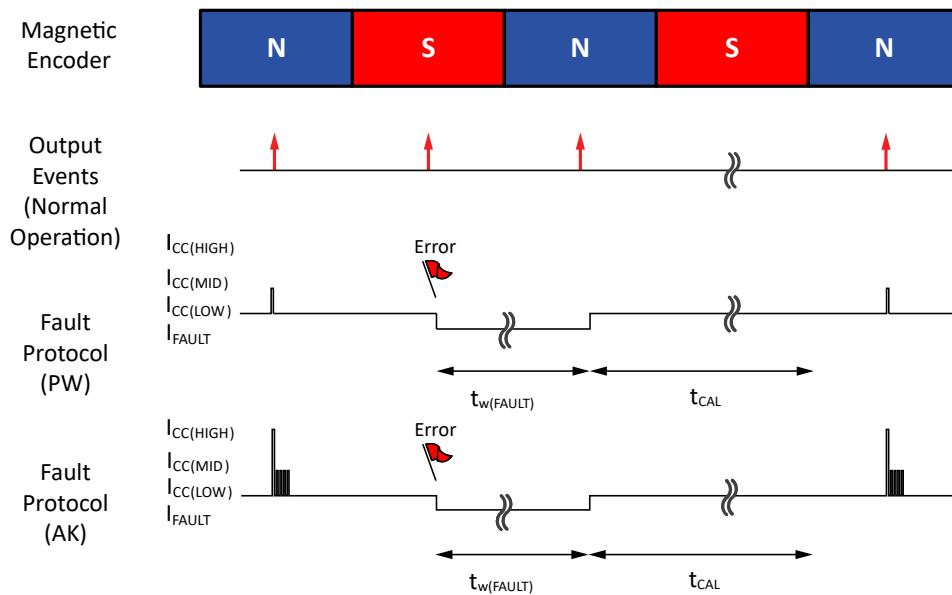

Figure 14: Output Protocol (ASIL Safe State)

POWER DERATING

The device must be operated below the maximum junction temperature of the device ($T_{J(max)}$). Under certain combinations of peak conditions, reliable operation may require derating supplied power or improving the heat dissipation properties of the application. This section presents a procedure for correlating factors affecting operating T_J . (Thermal data is also available on the Allegro MicroSystems website.)

The Package Thermal Resistance ($R_{\theta JA}$) is a figure of merit summarizing the ability of the application and the device to dissipate heat from the junction (die), through all paths to the ambient air. Its primary component is the Effective Thermal Conductivity (K) of the printed circuit board, including adjacent devices and traces. Radiation from the die through the device case ($R_{\theta JC}$) is a relatively small component of $R_{\theta JA}$. Ambient air temperature (T_A) and air motion are significant external factors, damped by overmolding.

The effect of varying power levels (Power Dissipation or P_D), can be estimated. The following formulas represent the fundamental relationships used to estimate T_J , at P_D .

$$P_D = V_{IN} \times I_{IN} \quad (1)$$

$$\Delta T = P_D \times R_{\theta JA} \quad (2)$$

$$T_J = T_A + \Delta T \quad (3)$$

For example, given common conditions such as: $T_A = 25^\circ\text{C}$, $V_{CC} = 12\text{ V}$, $I_{CC} = 7.15\text{ mA}$, and $R_{\theta JA} = 213^\circ\text{C/W}$, then:

$$P_D = V_{CC} \times I_{CC} = 12\text{ V} \times 7.15\text{ mA} = 85.8\text{ mW}$$

$$\Delta T = P_D \times R_{\theta JA} = 85.8\text{ mW} \times 213^\circ\text{C/W} = 18.3^\circ\text{C}$$

$$T_J = T_A + \Delta T = 25^\circ\text{C} + 18.3^\circ\text{C} = 43.3^\circ\text{C}$$

A worst-case estimate, $P_{D(max)}$, represents the maximum allowable power level ($V_{CC(max)}$, $I_{CC(max)}$), without exceeding $T_{J(max)}$, at a selected $R_{\theta JA}$ and T_A .

Example: Reliability for V_{CC} at $T_A = 150^\circ\text{C}$, package UB, using minimum-K PCB.

Observe the worst-case ratings for the device, specifically: $R_{\theta JA} = 213^\circ\text{C/W}$, $T_{J(max)} = 175^\circ\text{C}$, $V_{CC(max)} = 24\text{ V}$, and $I_{CC(AVG)} = 16.6\text{ mA}$. $I_{CC(AVG)}$ is computed using $I_{CC(HIGH)(max)}$, $I_{CC(MID)(max)}$, and $I_{CC(LOW)(max)}$, with an input signal frequency of $f_{SIG(max)}$ (AK protocol).

Calculate the maximum allowable power level ($P_{D(max)}$). First, invert equation 3:

$$\Delta T_{max} = T_{J(max)} - T_A = 175^\circ\text{C} - 150^\circ\text{C} = 25^\circ\text{C}$$

This provides the allowable increase to T_J resulting from internal power dissipation. Then, invert equation 2:

$$P_{D(max)} = \Delta T_{max} \div R_{\theta JA} = 25^\circ\text{C} \div 213^\circ\text{C/W} = 117.4\text{ mW}$$

Finally, invert equation 1 with respect to voltage:

$$V_{CC(est)} = P_{D(max)} \div I_{CC(AVG)} = 117.4\text{ mW} \div 16.6\text{ mA} = 7.0\text{ V}$$

The result indicates that, at T_A , the application and device can dissipate adequate amounts of heat at voltages $\leq V_{CC(est)}$.

Compare $V_{CC(est)}$ to $V_{CC(max)}$. If $V_{CC(est)} \leq V_{CC(max)}$, then reliable operation between $V_{CC(est)}$ and $V_{CC(max)}$ requires enhanced $R_{\theta JA}$. If $V_{CC(est)} \geq V_{CC(max)}$, then operation between $V_{CC(est)}$ and $V_{CC(max)}$ is reliable under these conditions.

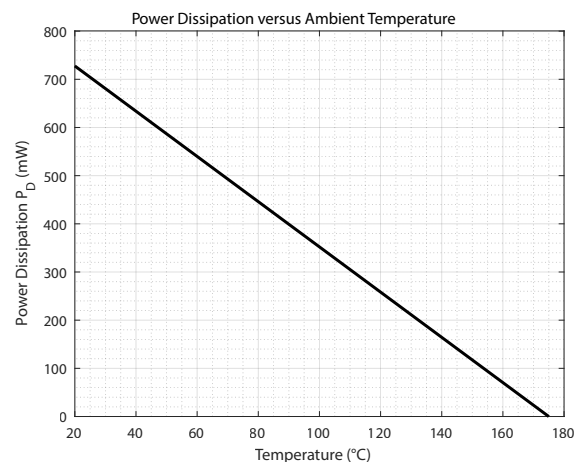
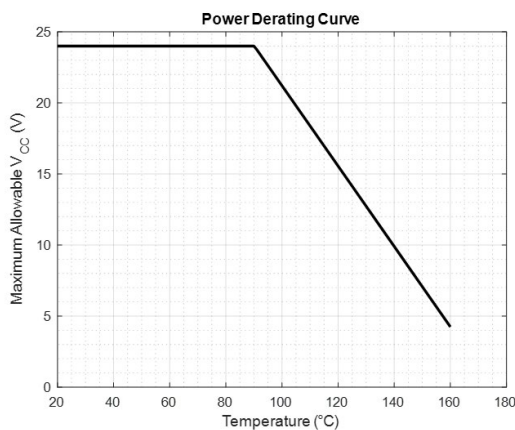

PACKAGE OUTLINE DRAWING

For Reference Only – Not for Tooling Use

(Reference DWG-0000408, Rev. 4)
Dimensions in millimeters – NOT TO SCALE

Exact case and lead configuration at supplier discretion within limits shown

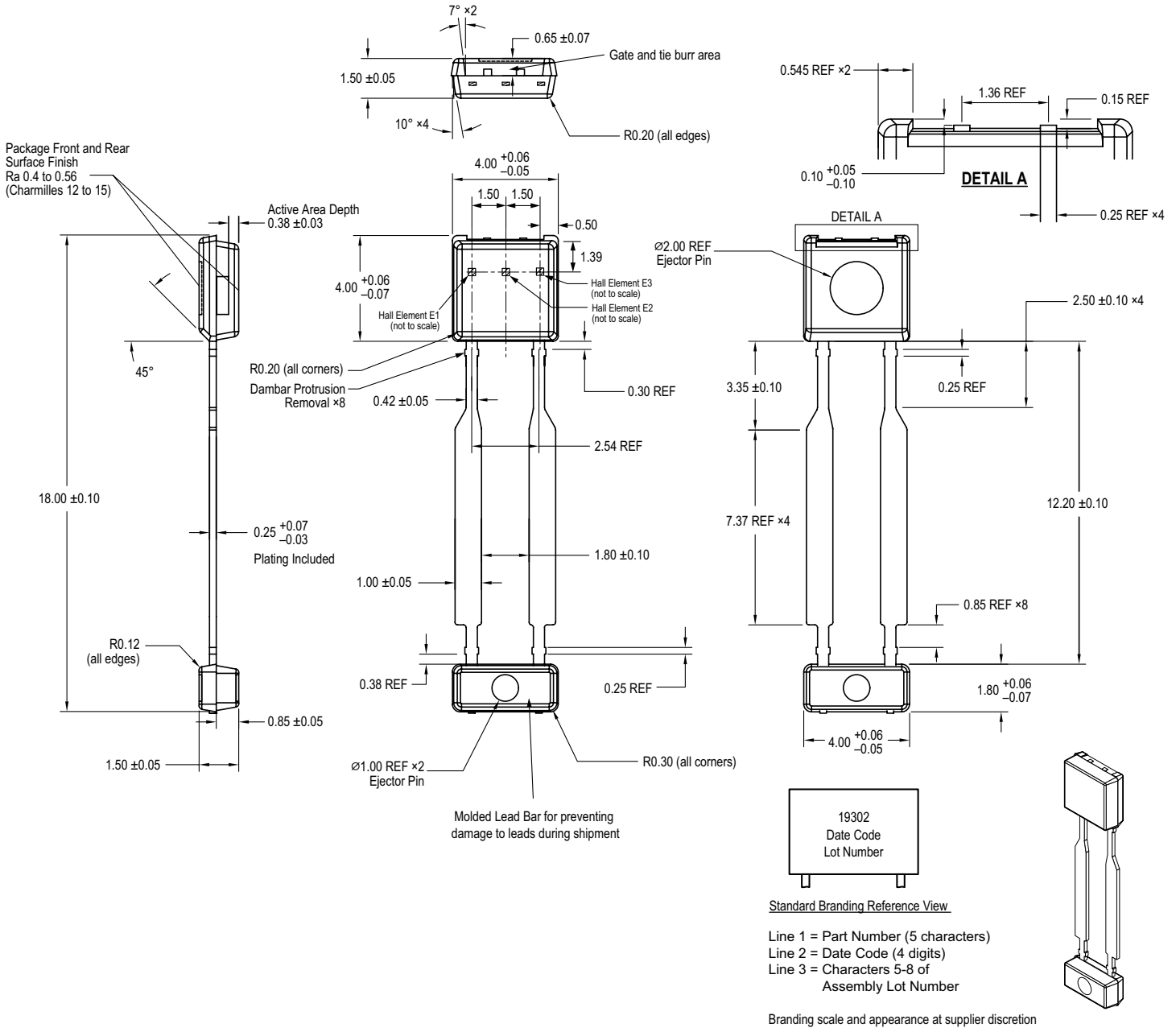

Figure 15: Package UB, 2-Pin SIP

Revision History

Number	Date	Description
–	February 24, 2020	Initial release
1	April 9, 2020	Updated Selection Guide
2	May 21, 2020	Updated ASIL assessment status (pages 1-2), Operating Differential Magnetic Input test conditions (page 4), ASIL Fault Pulse Width characteristic name (page 5), and Footnote 6 (page 6).
3	September 18, 2020	Updated ASIL status (pages 1-2) and other minor editorial updates.
4	October 14, 2020	Added Description of AK Protocol (page 10).
5	December 9, 2021	Updated Figure 9 (page 9) and Bit 4 Coding (page 10).
6	April 24, 2024	Updated package drawing (page 16)
7	May 12, 2025	Updated ASIL logo and text (pages 1 and 14)
8	September 24, 2025	Updated cross-references (page 5); updated Output Timing Example diagram (page 9)

Copyright 2025, Allegro MicroSystems.

Allegro MicroSystems reserves the right to make, from time to time, such departures from the detail specifications as may be required to permit improvements in the performance, reliability, or manufacturability of its products. Before placing an order, the user is cautioned to verify that the information being relied upon is current.

Allegro's products are not to be used in any devices or systems, including but not limited to life support devices or systems, in which a failure of Allegro's product can reasonably be expected to cause bodily harm.

The information included herein is believed to be accurate and reliable. However, Allegro MicroSystems assumes no responsibility for its use; nor for any infringement of patents or other rights of third parties which may result from its use.

Copies of this document are considered uncontrolled documents.

For the latest version of this document, visit our website:

www.allegromicro.com

Looking for pricing, stock, or lifecycle information?

Click below to explore more details on WIN SOURCE:

 [View A19302PUBATN-RAE on WIN SOURCE](#)

 [Allegro MicroSystems, LLC](#) Information

Optimize Your Supply Chain with WIN SOURCE Solutions

-  Global Sourcing Solution
-  Obsolete Management
-  Cost Control Management
-  Shortage Management
-  Alternative Solution
-  Excess Inventory Management