



TGA2817-SM

S-Band 60 W GaN Power Amplifier

General Description

Qorvo's TGA2817-SM is a high-power, S-band amplifier fabricated on Qorvo's TQGaN25 0.25 um GaN on SiC production process. Covering 2.9-3.5 GHz, the TGA2817-SM provides > 48 dBm of saturated output power and > 24 dB of large-signal gain while achieving > 54 % power added efficiency.

The TGA2817-SM can also support a variety of operating conditions to best support system requirements. With good thermal properties, it can support a range of bias voltages and will perform well under pulse applications. The TGA2817-SM is matched to 50 ohms with integrated DC blocking caps on both I/O ports. It is ideal for use in both commercial and military radar systems.

Lead-free and RoHS compliant

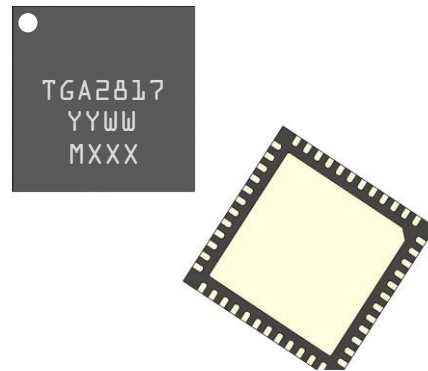

Product Features

- Frequency Range: 2.9–3.5 GHz
- P_{OUT}: > 48 dBm (at P_{IN} = 24 dBm)
- Large Signal Gain: > 24 dB (at P_{IN} = 24 dBm)
- PAE: > 54 % (at P_{IN} = 24 dBm)
- Bias: V_D = 28 V, I_{DQ} = 200 mA
- Package Dimensions: 7.00 x 7.00 x 0.85 mm

Functional Block Diagram

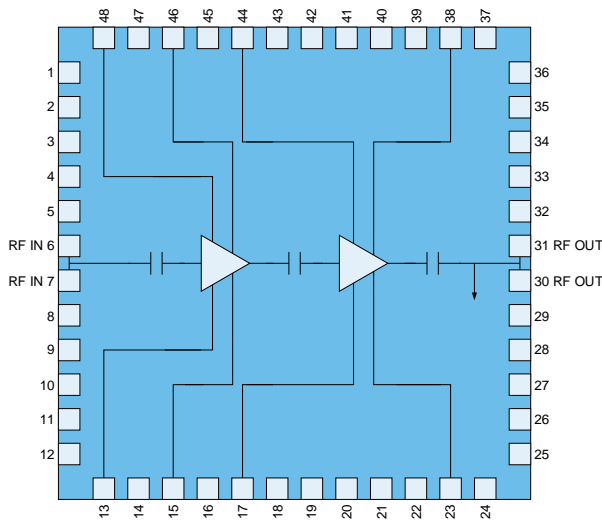

Applications

- Military Radar
- Commercial Radar

Ordering Information

Part	Description
TGA2817-SM	S-Band 60 W GaN Power Amplifier
TGA2817-SM_EVB	TGA2817-SM Evaluation Board

Absolute Maximum Ratings

Parameter	Value/Range
Drain Voltage (V_D)	40 V
Drain Current (I_{D1}/I_{D2})	1.4 / 5.8 A
Gate Current (I_G)	See graph, page 8
Dissipated Power (P_{DISS})	92 W
Input Power: 50 Ω , 85 °C ⁽¹⁾	30 dBm
Input Power: 3:1 VSWR, 85 °C ⁽¹⁾	28 dBm
Soldering Temperature	260 °C
Storage Temperature	-55 to 150 °C

Notes:

1. Based on die performance.

Operation of this device outside the parameter ranges given above may cause permanent damage.

Electrical Specifications

Test conditions, unless otherwise noted: 25 °C, $V_D = 28$ V, $I_{DQ} = 200$ mA, Pulse Width = 100 μ s, Duty Cycle = 10%

Parameter	Condition	Min	Typical	Max	Units
Operational Frequency		2.9		3.5	GHz
Output Power ($P_{IN} = 24$ dBm)	2.9 GHz	47.2	48		dBm
	3.1 GHz	47.2	48		dBm
	3.3 GHz	47.4	48		dBm
Power Added Efficiency ($P_{IN} = 24$ dBm)	2.9 GHz	49.5	54		%
	3.1 GHz	48.0	54		%
	3.3 GHz	47.0	54		%
Large Signal Gain ($P_{IN} = 24$ dBm)			24		dB
Input Return Loss			>8		dB
Gate Leakage ($V_D = 10$ V, $V_G = -3.7$ V)		-30.6	-0.46	-0.0001	mA
Output Power Temperature Coefficient			-0.006		dBm/°C

Recommended Operating Conditions

Parameter	Value/Range
Drain Voltage (V_D)	28 V
Drain Current (quiescent, I_{DQ})	200 mA
Drain Current (under drive, I_{D_DRIVE})	4.6 A
Gate Voltage Range (V_G)	-2.8 to -2.0 V
Operating Temperature	-40 to 85 °C

Electrical specifications are measured at specified test conditions. Specifications are not guaranteed over all recommended operating conditions.

Typical Performance

Test conditions unless otherwise noted: Temp. = 25 °C

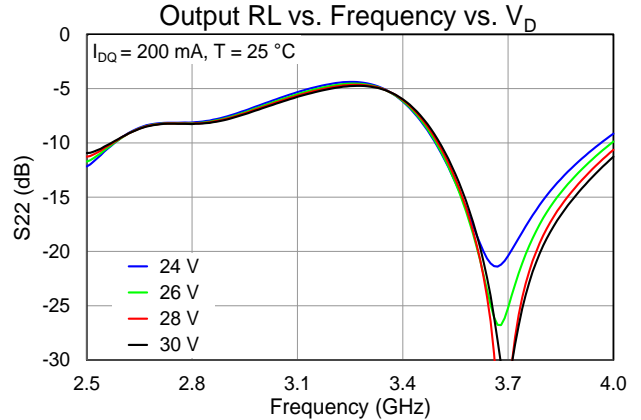
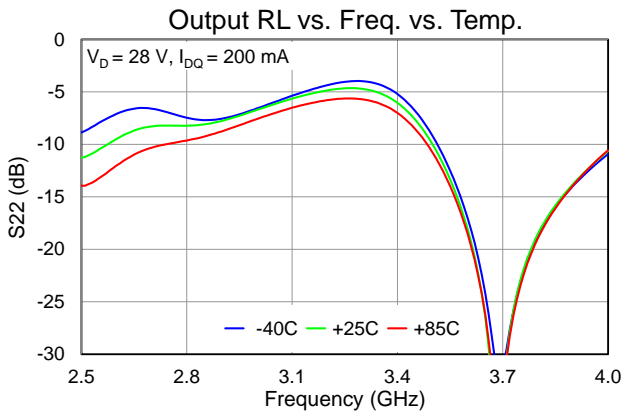
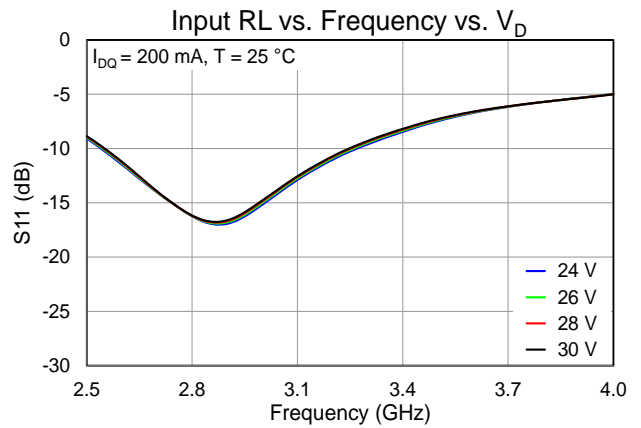
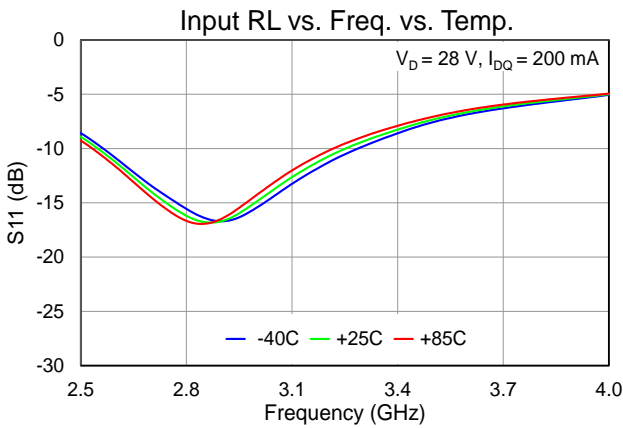
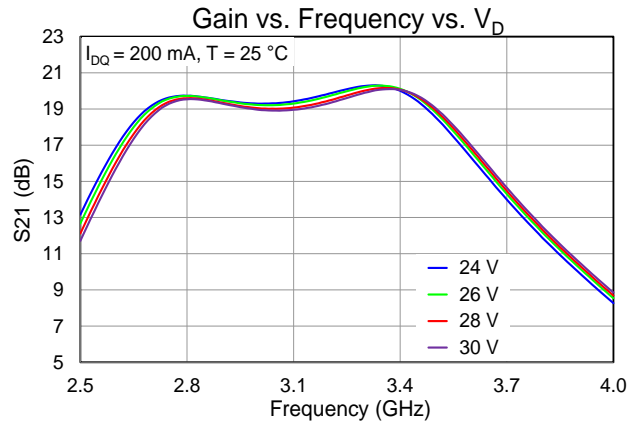
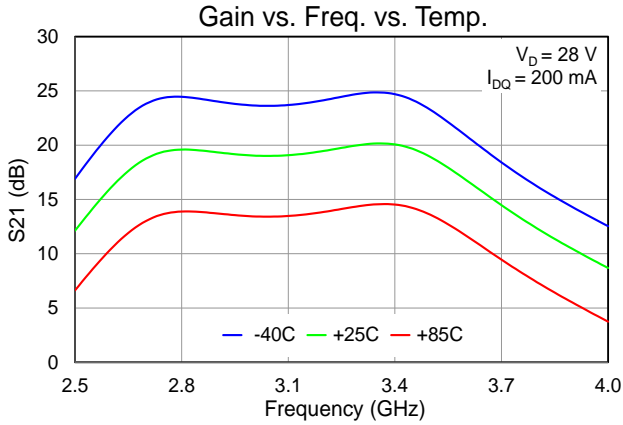

Typical Performance

Test conditions unless otherwise noted: Temp. = 25 °C

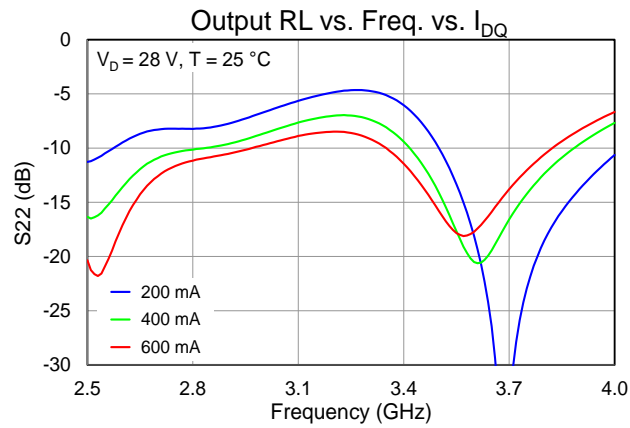
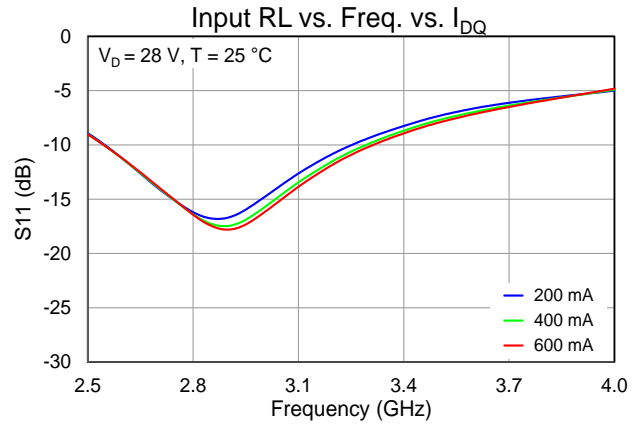
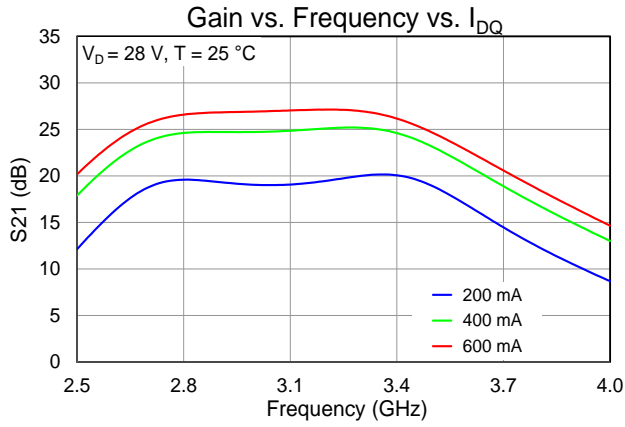

Typical Performance

Test conditions unless otherwise noted: Temp. = 25 °C, Pulsed input power PW = 100 us, Duty Cycle = 10%

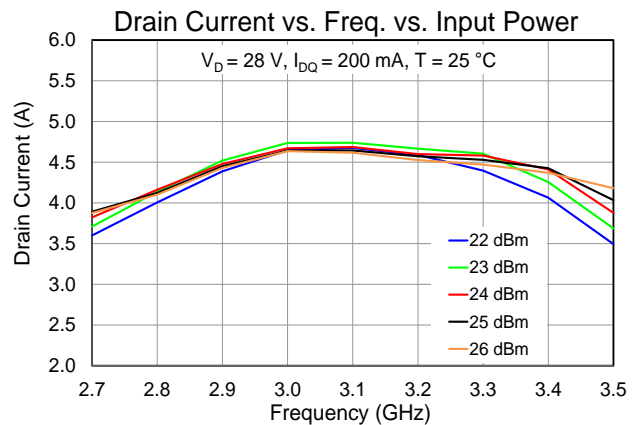
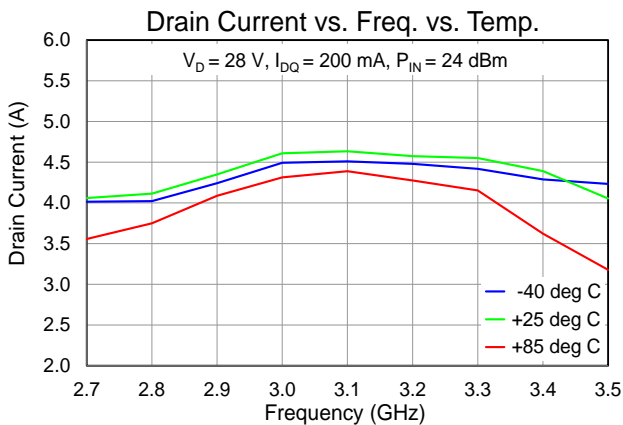
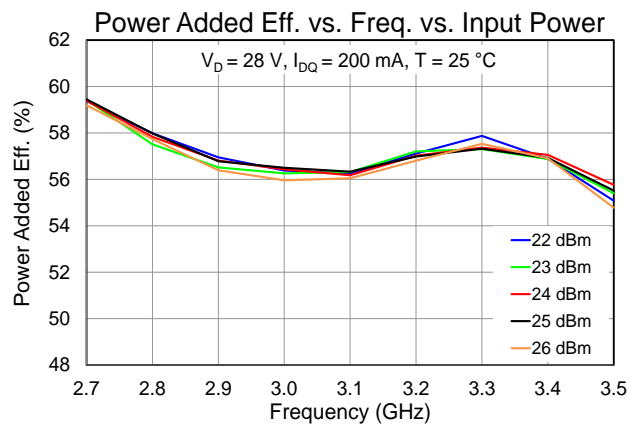
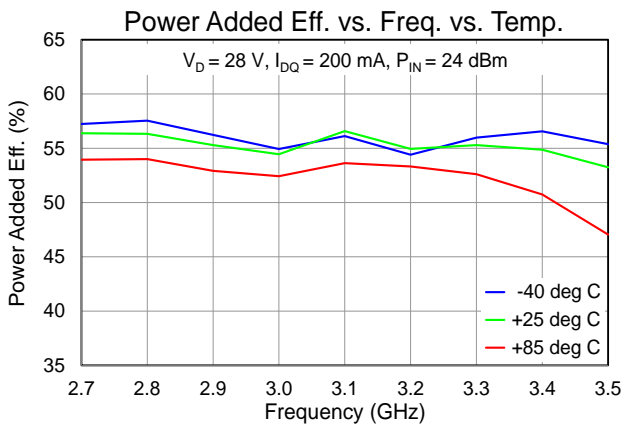
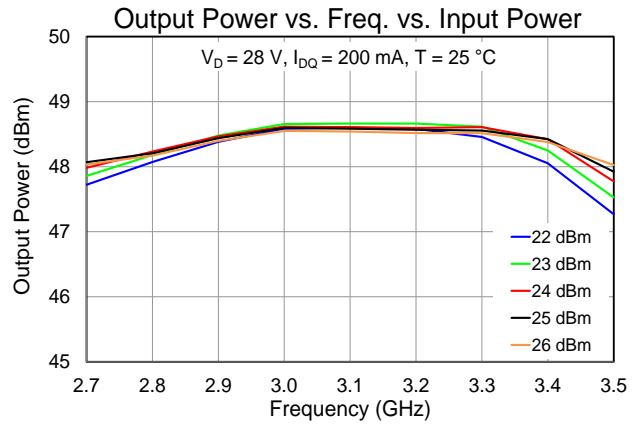
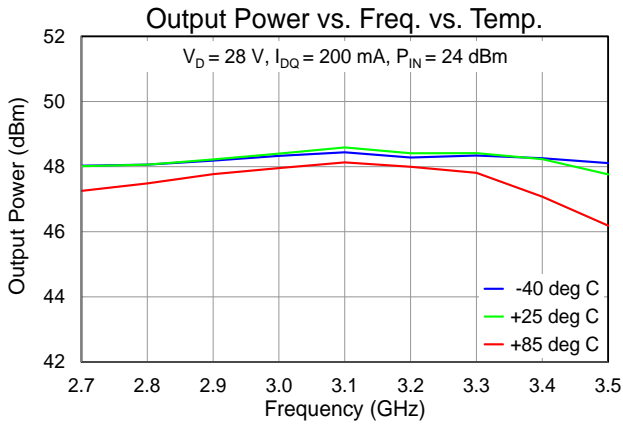

Typical Performance

Test conditions unless otherwise noted: Pulsed input power PW = 100 us, Duty Cycle = 10%

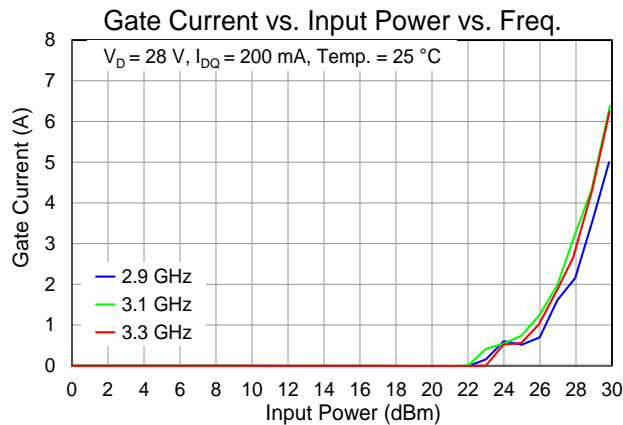
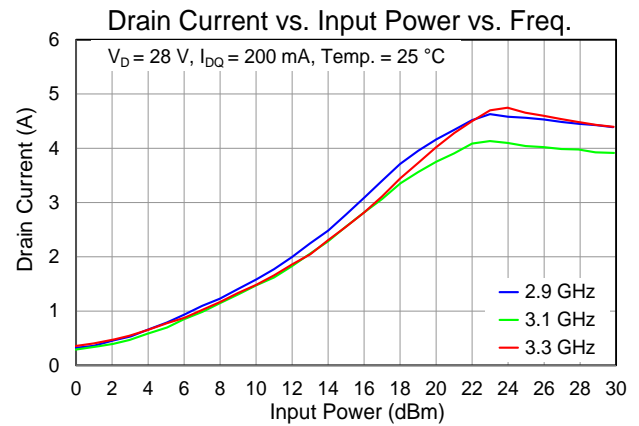
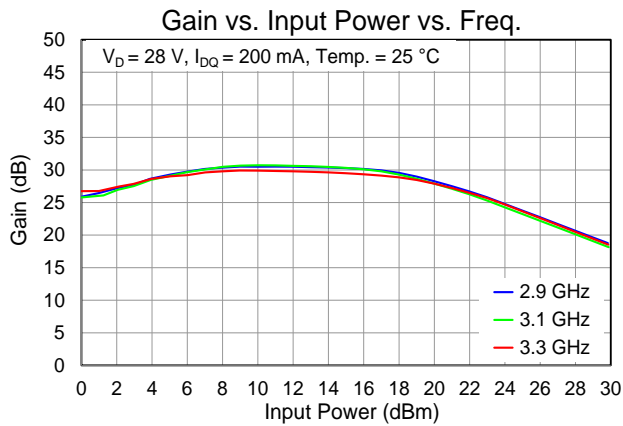
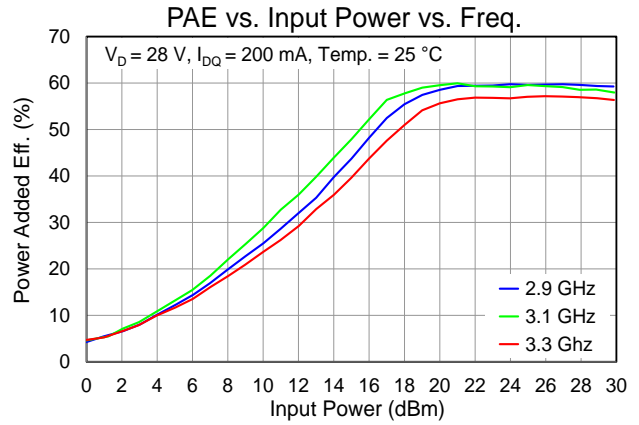
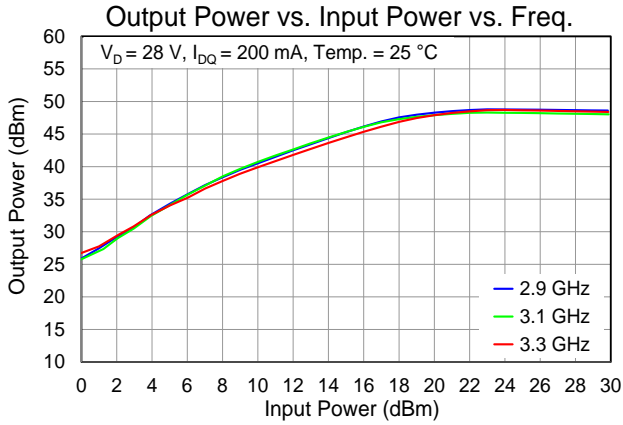

Typical Performance

Test conditions unless otherwise noted: Pulsed input power PW = 100 us, Duty Cycle = 10%

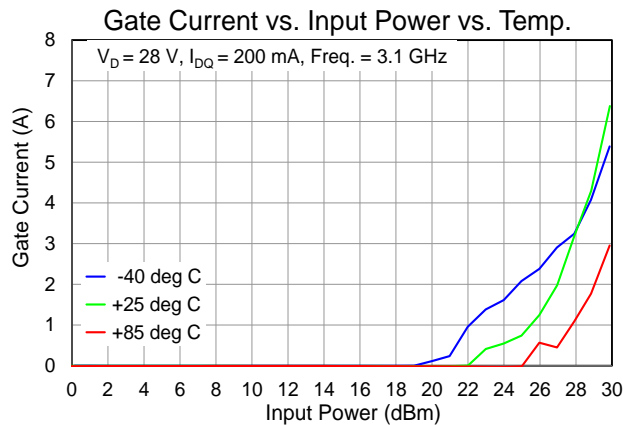
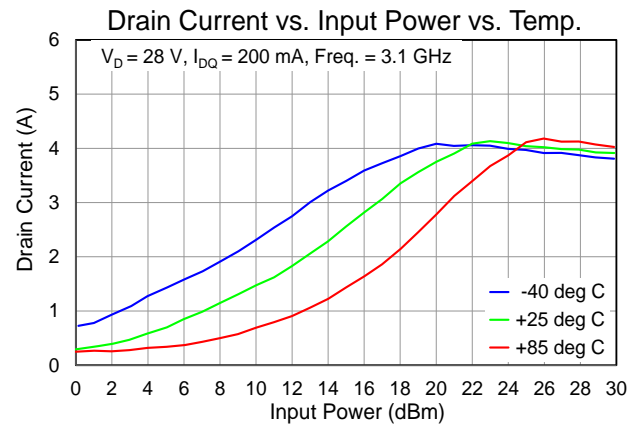
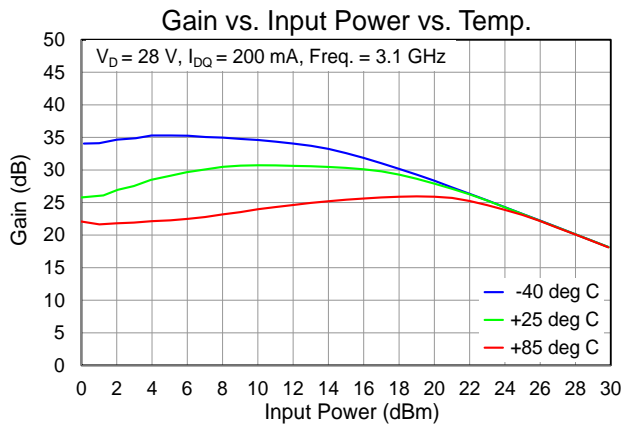
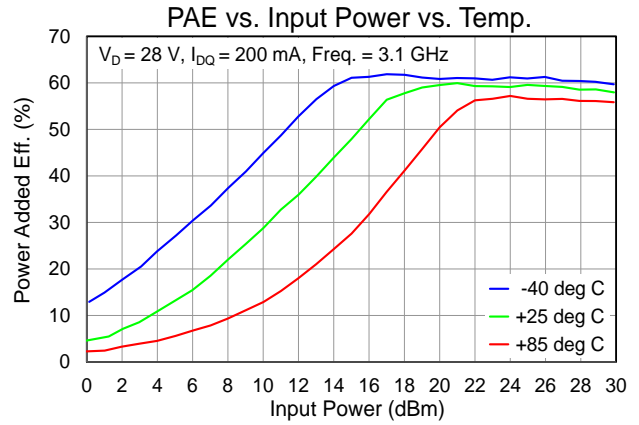
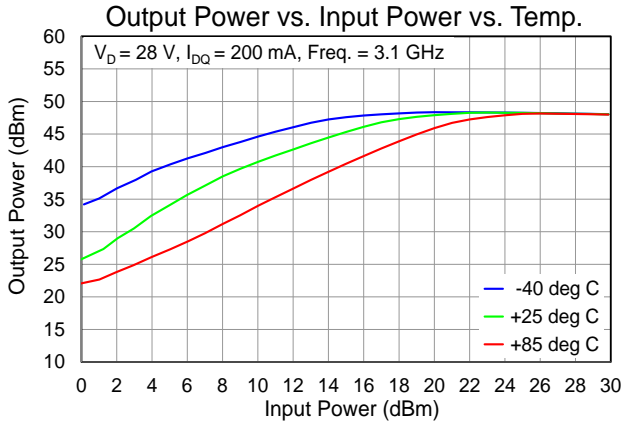

Thermal and Reliability Information

Parameter	Test Conditions	Value	Units
Thermal Resistance (θ_{JC}) ⁽¹⁾	$T_{BASE} = 85\text{ }^{\circ}\text{C}$, $V_D = 28\text{ V}$, $I_D = 200\text{ mA}$ (quiescent DC, small signal), $P_{DISS} = 6.4\text{ W}$	0.396	$^{\circ}\text{C/W}$
Channel Temperature (T_{CH}) ⁽²⁾		87.5	$^{\circ}\text{C}$
Thermal Resistance (θ_{JC}) ⁽¹⁾	$T_{BASE} = 85\text{ }^{\circ}\text{C}$, $V_D = 28\text{ V}$, $I_D = 4.5\text{ A}$, $P_{IN} = 24\text{ dBm}$, $P_{OUT} = 48.5\text{ dBm}$, $PW = 100\text{ }\mu\text{s}$, $DC = 10\%$, $P_{DISS} = 53\text{ W}$	0.476	$^{\circ}\text{C/W}$
Channel Temperature (T_{CH}) ⁽²⁾		110.2	$^{\circ}\text{C}$
Thermal Resistance (θ_{JC}) ⁽¹⁾	$T_{BASE} = 85\text{ }^{\circ}\text{C}$, $V_D = 32\text{ V}$, $I_D = 5.1\text{ A}$, $P_{IN} = 24\text{ dBm}$, $P_{OUT} = 49.4\text{ dBm}$, $PW = 100\text{ }\mu\text{s}$, $DC = 10\%$, $P_{DISS} = 74\text{ W}$	0.492	$^{\circ}\text{C/W}$
Channel Temperature (T_{CH}) ⁽²⁾		121.4	$^{\circ}\text{C}$

Notes:

- Thermal resistance is determined to the back of the package (at 85 °C).
- IR scan equivalent. Refer to the following document: [GaN Device Channel Temperature, Thermal Resistance, and Reliability Estimates](#)

Power Dissipation and Maximum Gate Current

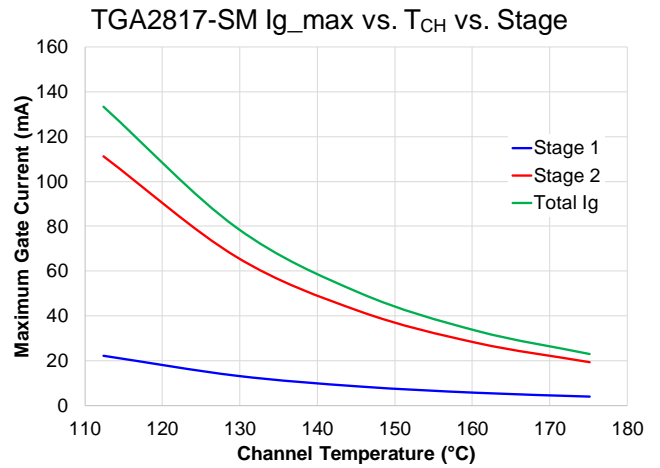
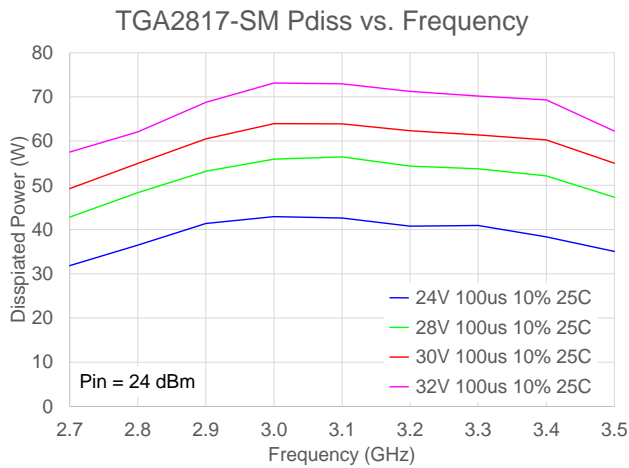

Application Circuit

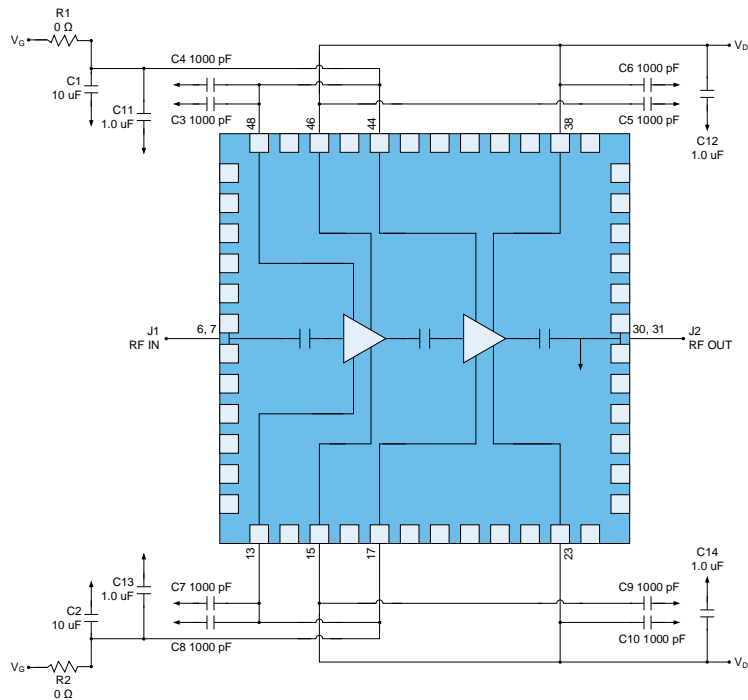

Notes:

1. V_G and V_D must be biased from both sides (top and bottom).

Bias-up Procedure

- Set I_D limit to 6000 mA, I_G limit to 40 mA

- Set V_G to -6.0 V

- Set V_D +28 V

- Adjust V_G more positive until $I_{DQ} = 200$ mA

- Apply RF signal

Bias-down Procedure

- Turn off RF signal

- Reduce V_G to -6.0 V. Ensure $I_{DQ} \sim 0$ mA

- Set V_D to 0 V

- Turn off V_D supply

- Turn off V_G supply

Evaluation Board and Mounting Detail

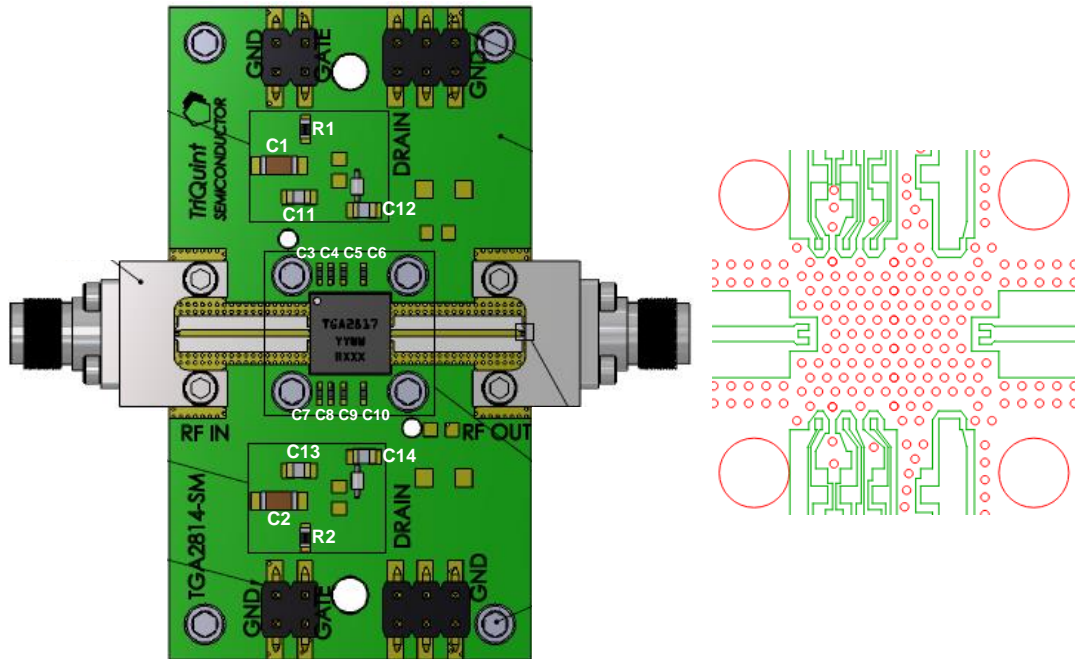

RF Layer is 0.008" thick Rogers Corp. RO40003C ($\epsilon_r = 3.35$). Metal layers are 0.5 oz. copper. The microstrip line at the connector interface is optimized for the Southwest Microwave end launch connector 1092-02A-5.

Reference Design	Component	Value	Manufacture	Part Number
C1, C2	Surface Mount Cap	10 uF, 20 %, 50 V (1206), X5R	Various	
C3–C10	Surface Mount Cap	1000 pF, 10 %, 50 V (0402), X7R	Various	
C11–C14	Surface Mount Cap	1.0 uF, 10 %, 25 V (0402), X7R	Various	
R1, R2	Surface Mount Res	0 Ohm, 5 % (0603)	Various	

Mechanical Drawing and Pad Description

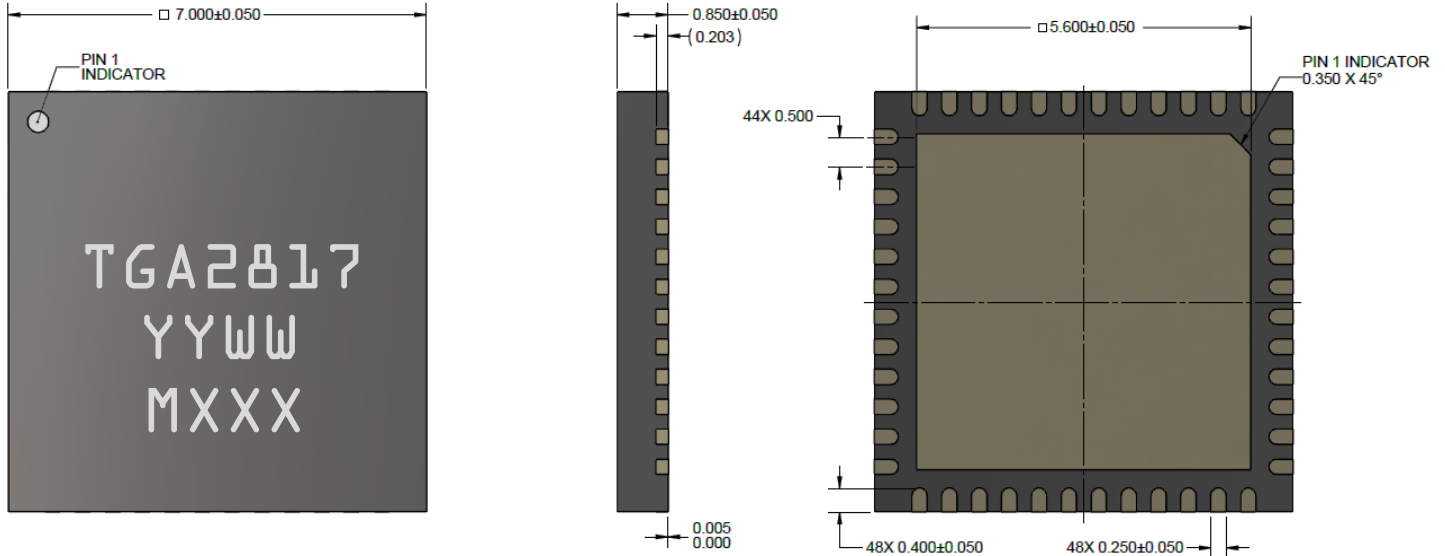

Package Leads are Gold Plated
Part is Mold Encapsulated
Dimensions are in mm
Tolerances: .XX = ± .25, .XXX = ± .127
Markings:
TGA2817: Part Number
YY: Assembly Year
WW: Assembly Week
MXXX: Batch ID

Pad No.	Symbol	Description
1-5, 8-12, 14, 16, 18-22, 24-29, 32-37, 39-43, 45, 47, 49	GND	Ground connection.
6, 7	RF Input	50 Ohm RF input. Pad is capacitively coupled to block on-chip DC voltages.
13, 48	V _{G1}	1 st Stage Gate Voltage; bias network is required; must be biased from both sides (V _{G1} and V _{G2} can be tied together in application)
15, 46	V _{D1}	1 st Stage Drain Voltage; bias network is required; must be biased from both sides (V _{D1} and V _{D2} can be tied together in application)
17, 44	V _{G2}	2 nd Stage Gate Voltage; bias network is required; must be biased from both sides (V _{G1} and V _{G2} can be tied together in application)
23, 38	V _{D2}	2 nd Stage Drain Voltage; bias network is required; must be biased from both sides (V _{D1} and V _{D2} can be tied together in application)
30, 31	RF Output	50 Ohm RF output. Pad is capacitively coupled to block on-chip DC voltages. Pad is DC grounded.

Recommended Soldering Temperature Profile

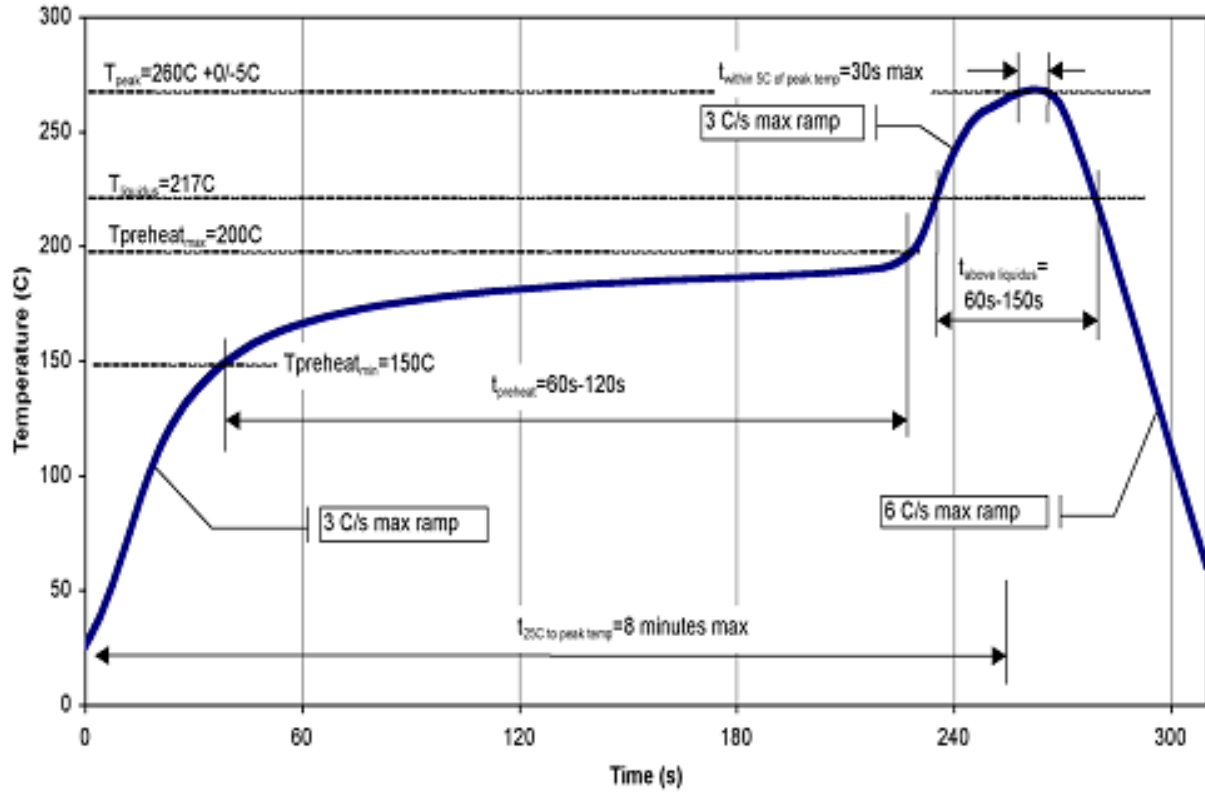

Handling Precautions

Parameter	Rating	Standard
ESD - Human Body Model (HBM)	1C	JEDEC/JS-001-2014
ESD- Charge Device Model (CDM)	C3	JEDEC/JS-002-2014
MSL - Moisture Sensitivity Level	MSL3	JEDEC/IPC/JEDEC J-STD-020



Caution!
ESD-Sensitive Device

Solderability

Compatible with the latest version of J-STD-020 Lead Free solder, 260 °C.

RoHS Compliance

This part is compliant with 2011/65/EU RoHS directive (Restrictions on the Use of Certain Hazardous Substances in Electrical and Electronic Equipment) as amended by Directive 2015/863/EU.

This product also has the following attributes:

- Lead Free
- Halogen Free (Chlorine, Bromine)
- Antimony Free
- TBBP-A (C₁₅H₁₂Br₄O₂) Free
- PFOS Free
- SVHC Free

Contact Information

For the latest specifications, additional product information, worldwide sales and distribution locations.

Web: www.qorvo.com

Tel: 1-844-890-8163

Email: customer.support@qorvo.com

Important Notice

The information contained herein is believed to be reliable; however, Qorvo makes no warranties regarding the information contained herein and assumes no responsibility or liability whatsoever for the use of the information contained herein. All information contained herein is subject to change without notice. Customers should obtain and verify the latest relevant information before placing orders for Qorvo products. The information contained herein or any use of such information does not grant, explicitly or implicitly, to any party any patent rights, licenses, or any other intellectual property rights, whether with regard to such information itself or anything described by such information. **THIS INFORMATION DOES NOT CONSTITUTE A WARRANTY WITH RESPECT TO THE PRODUCTS DESCRIBED HEREIN, AND QORVO HEREBY DISCLAIMS ANY AND ALL WARRANTIES WITH RESPECT TO SUCH PRODUCTS WHETHER EXPRESS OR IMPLIED BY LAW, COURSE OF DEALING, COURSE OF PERFORMANCE, USAGE OF TRADE OR OTHERWISE, INCLUDING THE IMPLIED WARRANTIES OF MERCHANTABILITY AND FITNESS FOR A PARTICULAR PURPOSE.**

Without limiting the generality of the foregoing, Qorvo products are not warranted or authorized for use as critical components in medical, life-saving, or life-sustaining applications, or other applications where a failure would reasonably be expected to cause severe personal injury or death.

Copyright 2019 © Qorvo, Inc. | Qorvo is a registered trademark of Qorvo, Inc.

Looking for pricing, stock, or lifecycle information?

Click below to explore more details on WIN SOURCE:

 [View TGA2817-SM on WIN SOURCE](#)

 [Qorvo US Inc. Information](#)

Optimize Your Supply Chain with WIN SOURCE Solutions

-  Global Sourcing Solution
-  Obsolete Management
-  Cost Control Management
-  Shortage Management
-  Alternative Solution
-  Excess Inventory Management