



QPA2811

X-Band 60 W GaN Power Amplifier

Product Overview

Qorvo's QPA2811 is a packaged, high-power X-band amplifier fabricated on Qorvo's production 0.15 μm GaN on SiC process (QGaN15). Covering 8.5–10.55 GHz, the QPA2811 provides 48.9 dBm of saturated output power and 27.9 dB of large-signal gain while achieving 48.5 % power-added efficiency.

The QPA2811 is packaged in a 7 mm x 7 mm 48-pin plastic overmolded package. It can support a variety of operating conditions to best support system requirements. With good thermal properties, it can support a range of bias voltages.

The QPA2811 MMIC RF ports are DC grounded and matched to 50 ohms. The QPA2811 is ideal for military radar systems.

Lead-free and RoHS compliant.

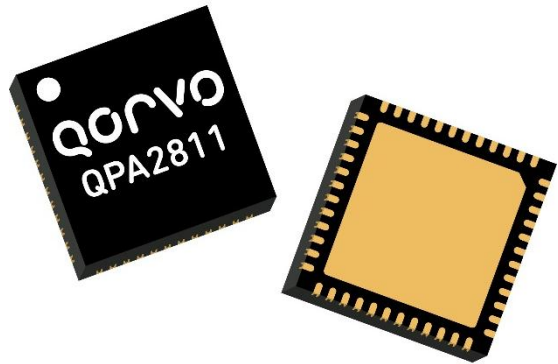

Key Features

- Frequency Range: 8.5–10.55 GHz
- P_{SAT} ($P_{IN}=21$ dBm): 48.9 dBm
- PAE ($P_{IN}=21$ dBm): 48.5 %
- Power Gain ($P_{IN}=21$ dBm): 27.9 dB
- Bias: $V_D = 24$ V, $I_{DQ} = 1.24$ A
- Package Dimensions: 7.0 x 7.0 x 0.82 mm

Performance is typical across frequency. Please reference electrical specification table and data plots for more details.

Functional Block Diagram

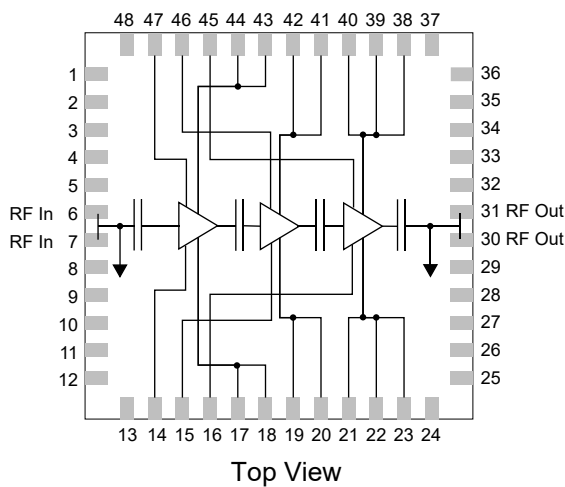

Applications

- Radar

Ordering Information

Part No.	Description
QPA2811	X-Band 60 W GaN Power Amplifier (10 pieces)
QPA2811TR7	7" tape and reel, 250 pieces
QPA2811EVB	Evaluation Board for QPA2811
QPA2811PCK01	QPA2811 EVB and Bias Controller Kit

Absolute Maximum Ratings

Parameter	Value / Range
Drain Voltage (V_D)	29.5 V
Gate Voltage Range (V_G)	-4 to +1 V
Drain Current (single side feed, I_{D1})	1 A
Drain Current (single side feed, I_{D2})	2 A
Drain Current (single side feed, I_{D3})	8 A
Gate Current (I_G)	See plot page 14
Power Dissipation (P_{DISS}), 85 °C	150 W
Input Power (P_{IN}), Pulsed, 50 Ω , $V_D=24$ V, $I_{DQ}=1.24$ A, 85 °C	30 dBm
Input Power (P_{IN}), Pulsed, 3:1 VSWR, $V_D=24$ V, $I_{DQ}=1.24$ A, 85 °C	27 dBm
Soldering Temperature (30 seconds)	260 °C
Storage Temperature	-55 to 150 °C

Operation of this device outside the parameter ranges given above may cause permanent damage. These are stress ratings only, and functional operation of the device at these conditions is not implied.

Recommended Operating Conditions

Parameter	Value / Range
Input Power (P_{IN})	21 dBm
Drain Voltage (V_D)	24 V
Quiescent Drain Current (I_{DQ_TOTAL})	1.24 A
Drain Current (Under drive, I_{D_TOTAL})	7.6 A
Operating Temperature	-40 to +85 °C

Electrical specifications are measured at specified test conditions. Specifications are not guaranteed over all recommended operating conditions.

Electrical Specifications

Parameter	Min	Typ	Max	Units
Operational Frequency Range	8.5		10.55	GHz
Saturated Output Power ($P_{IN} = 21$ dBm)		48.9		dBm
Power Added Efficiency ($P_{IN} = 21$ dBm)		48.5		%
Power Gain ($P_{IN} = 21$ dBm)		27.9		dB
Small Signal Gain		38		dB
Input Return Loss		21		dB
Output Return Loss		15		dB
Second Harmonic ($P_{OUT} = 48$ dBm, 9.5 GHz)		-44		dBc
Third Harmonic ($P_{OUT} = 48$ dBm, 9.5 GHz)		-36		dBc
Small Signal Temp. Coefficient (-40 °C to 85 °C)		-0.065		dB
P_{OUT} Temp. Coefficient ($P_{IN} = 21$ dBm, 25 °C to 85 °C)		-0.079		dB
Gate Leakage ($V_D = 10$ V, $V_G = -4.0$ V)	-30			mA

Test conditions, unless otherwise noted: $T = 25$ °C, $V_D = 24$ V, $I_{DQ} = 1.24$ A, $P_{IN} = 21$ dBm, $PW = 100$ μ s, Duty Cycle = 10%

Performance Plots – Large Signal (Pulsed)

Test conditions, unless otherwise noted: $V_D = 24\text{ V}$, $I_{DQ} = 1.24\text{ A}$, $PW = 100\text{ }\mu\text{s}$, Duty Cycle = 10%

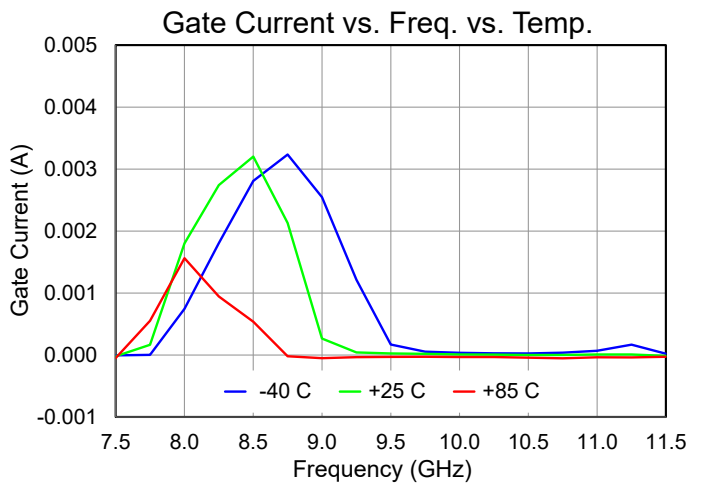
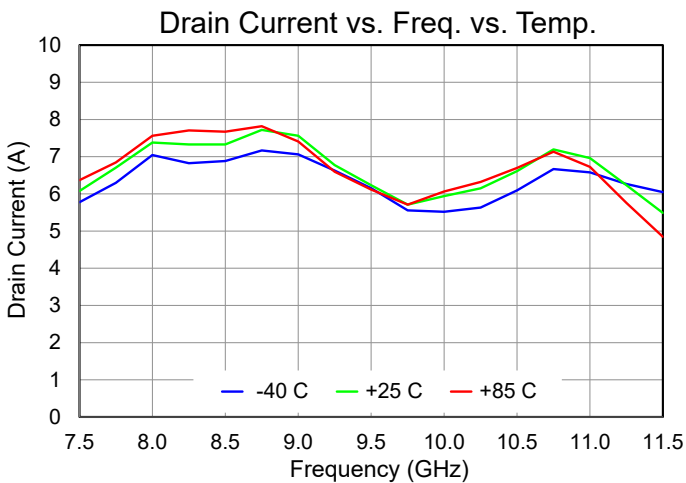
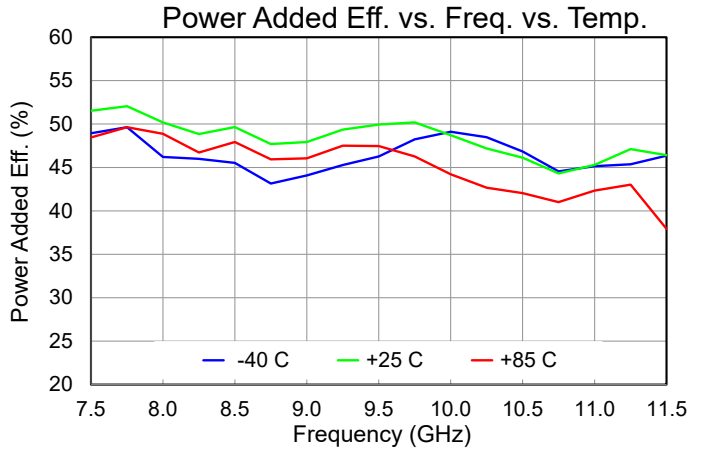
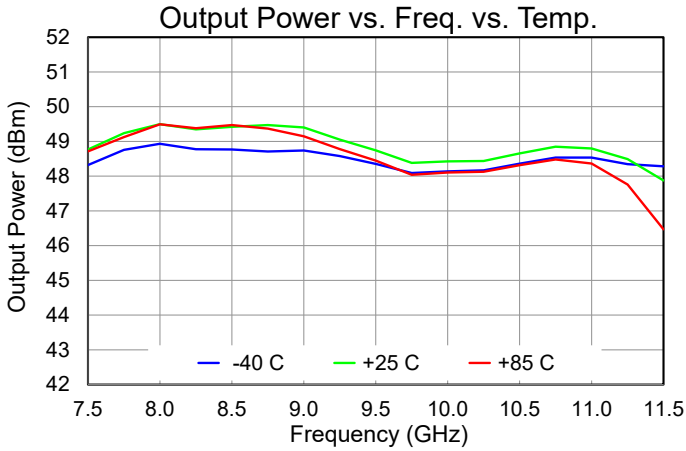

Input Power:
18 dBm at -40 °C
21 dBm at 25 °C
24 dBm at 85 °C

Performance Plots – Large Signal (Pulsed)

Test conditions, unless otherwise noted: $T = 25\text{ }^{\circ}\text{C}$, $I_{DQ} = 1.24\text{ A}$, $P_{IN} = 21\text{ dBm}$, $PW = 100\text{ }\mu\text{s}$, Duty Cycle = 10%

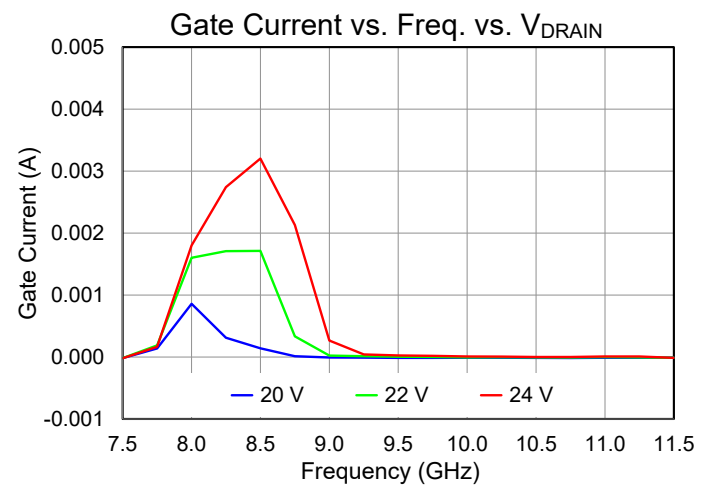
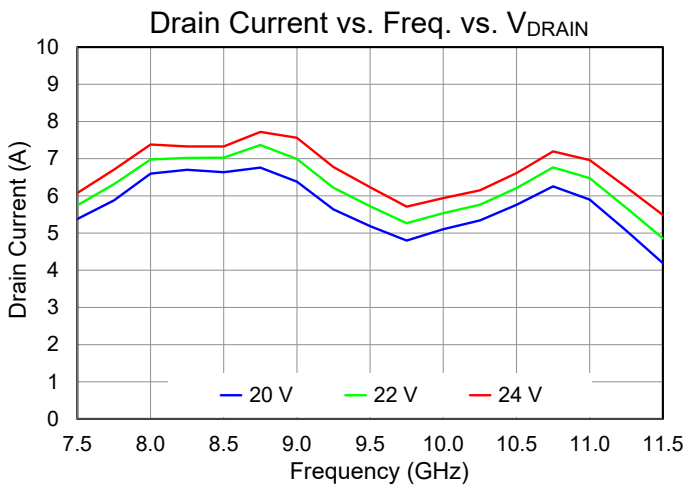
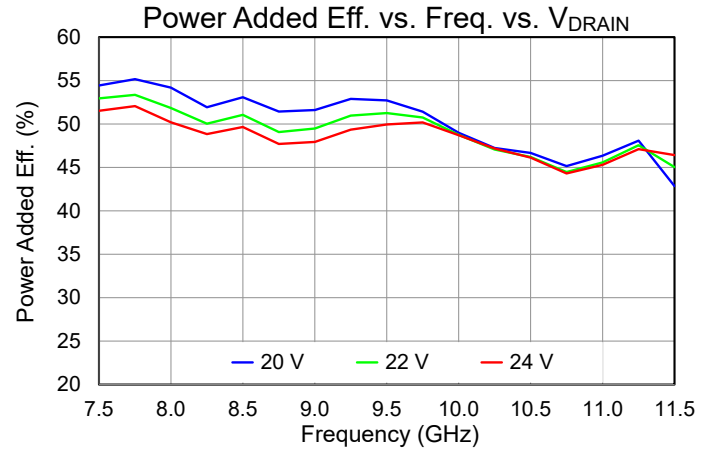
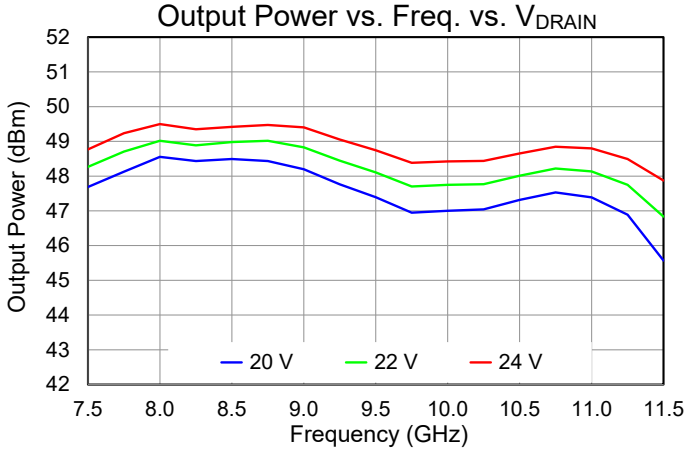

Performance Plots – Large Signal (Pulsed)

Test conditions, unless otherwise noted: $T = 25\text{ }^{\circ}\text{C}$, $V_D = 24\text{ V}$, $I_{DQ} = 1.24\text{ A}$, $PW = 100\text{ }\mu\text{s}$, Duty Cycle = 10%

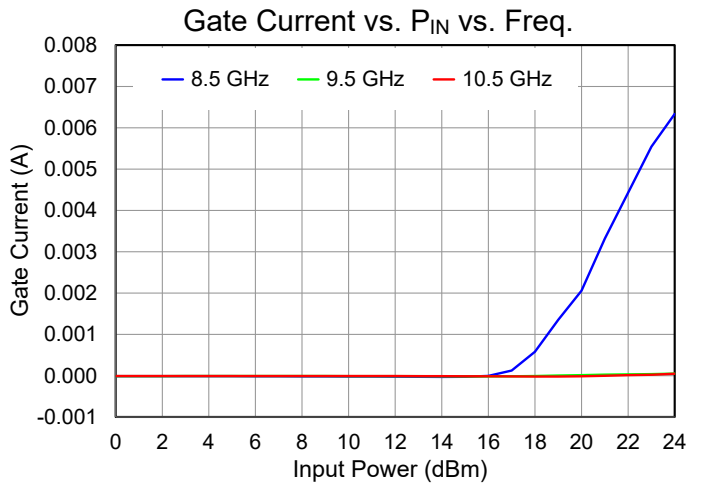
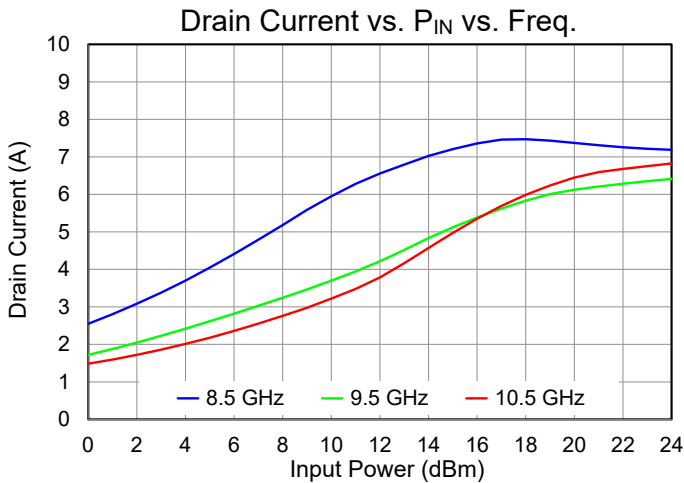
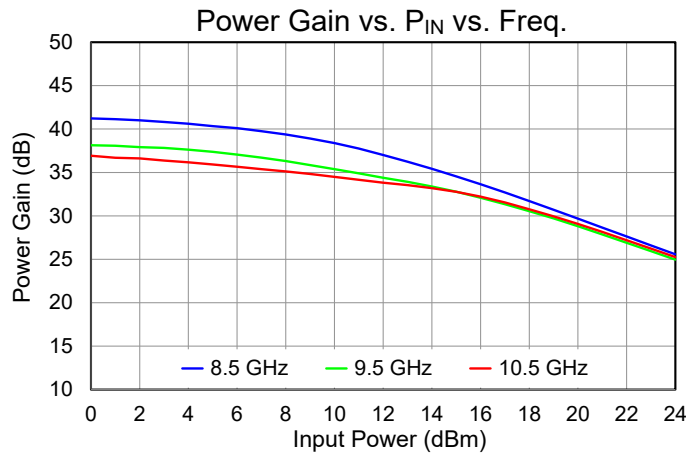
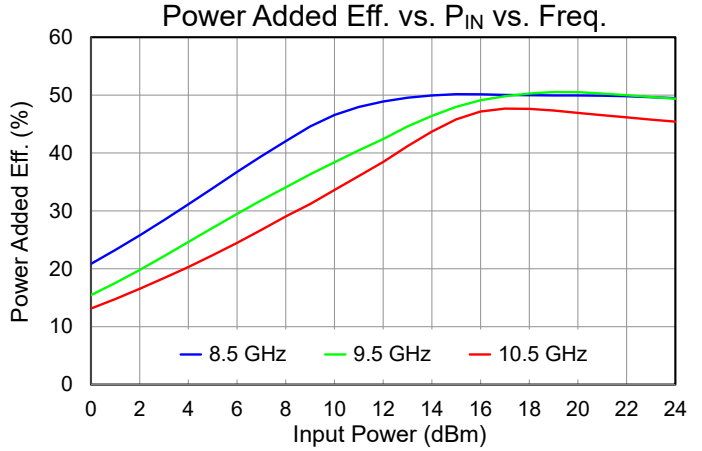
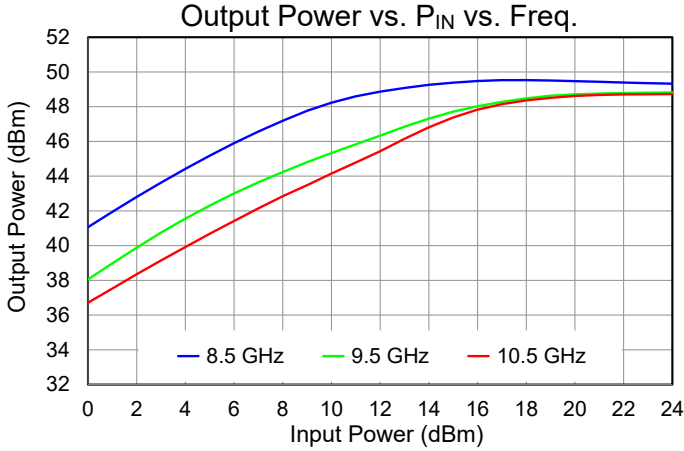

Performance Plots – Large Signal (Pulsed)

Test conditions, unless otherwise noted: $V_D = 24\text{ V}$, $I_{DQ} = 1.24\text{ A}$, $PW = 100\text{ }\mu\text{s}$, Duty Cycle = 10%

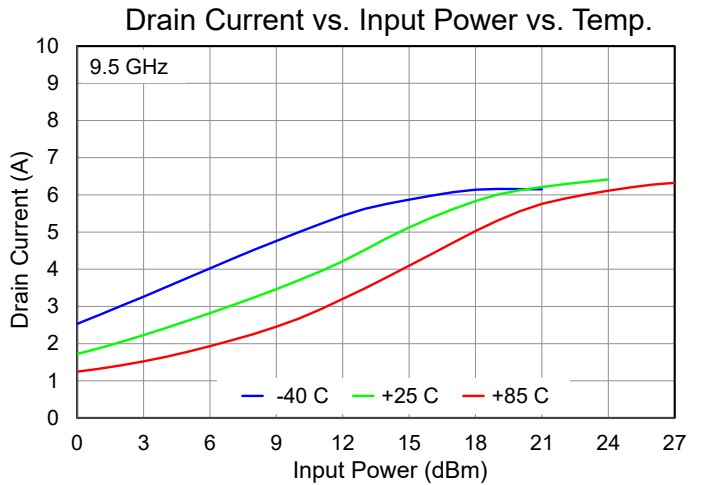
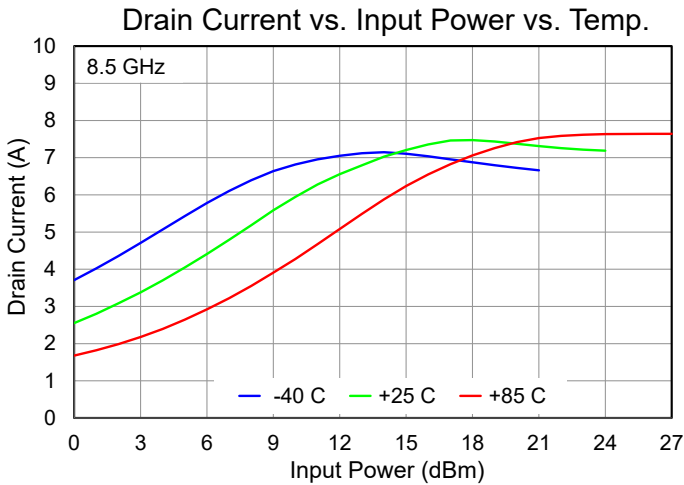
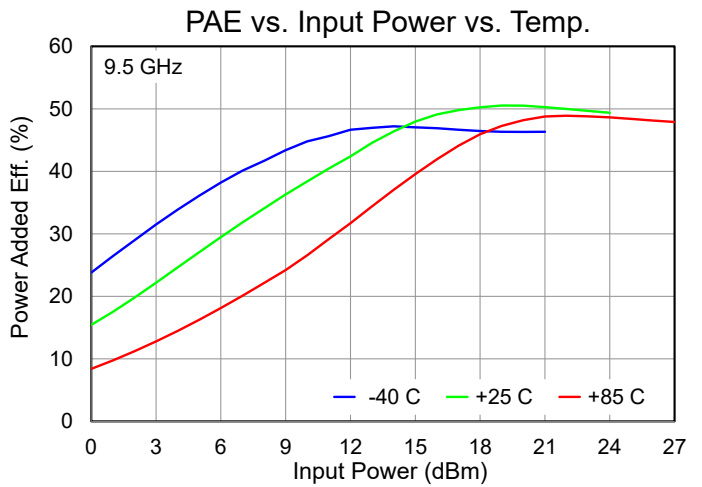
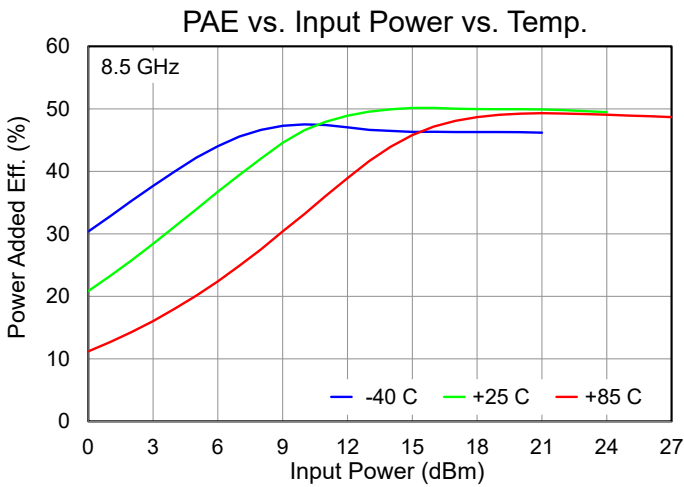
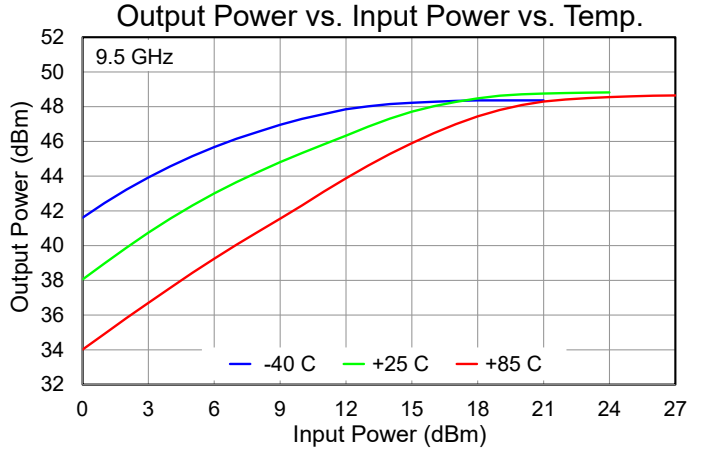
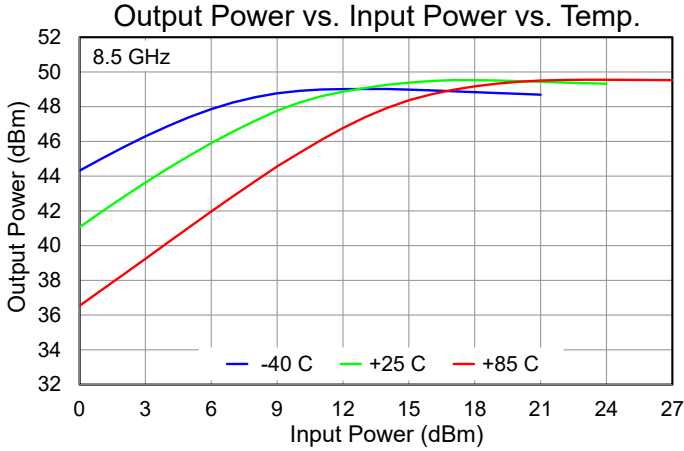

Performance Plots – Large Signal (Pulsed)

Test conditions, unless otherwise noted: $V_D = 24\text{ V}$, $I_{DQ} = 1.24\text{ A}$, $PW = 100\text{ }\mu\text{s}$, Duty Cycle = 10%

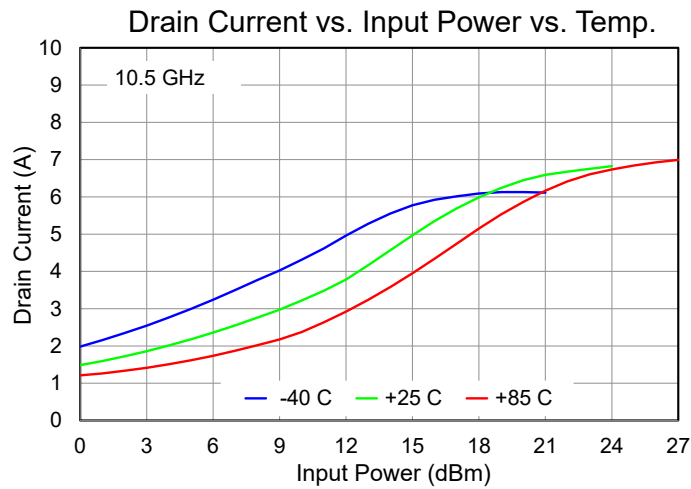
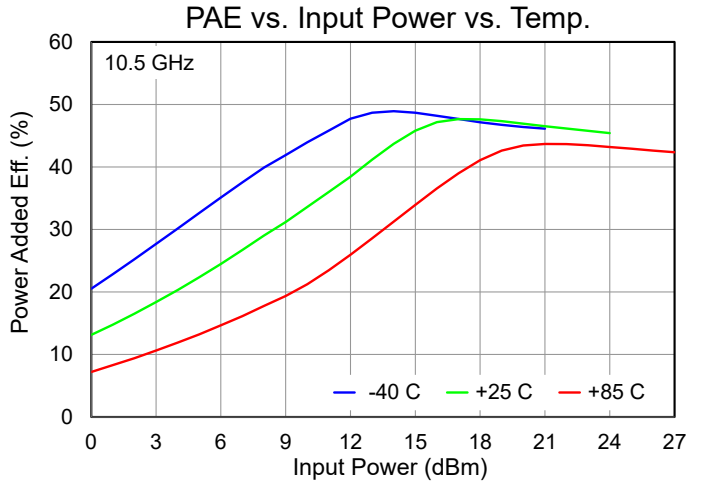
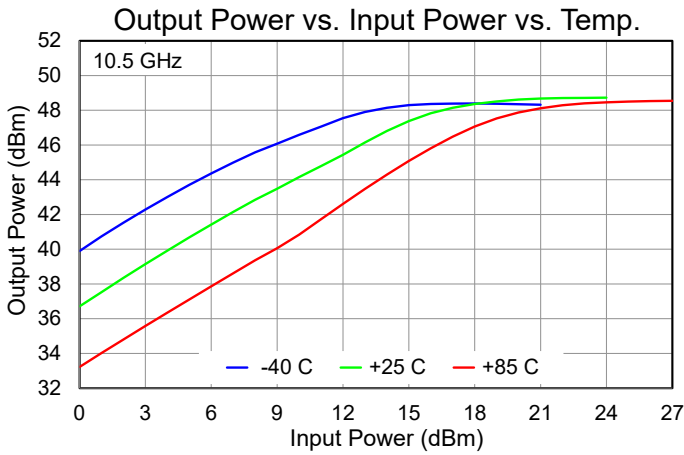

Performance Plots – Large Signal (Pulsed)

Test conditions, unless otherwise noted: T = 25 °C, I_{DQ} = 1.24 A, PW = 100 us, Duty Cycle = 10%

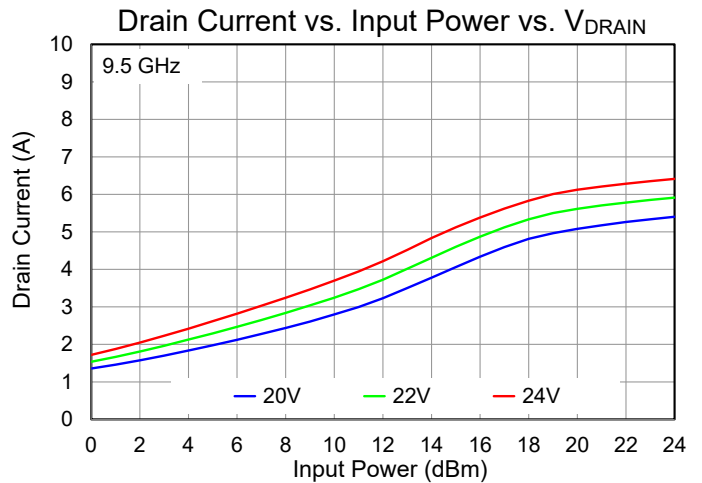
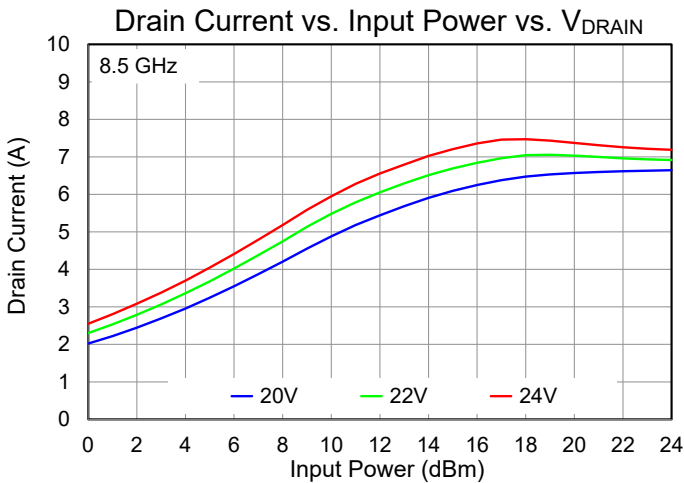
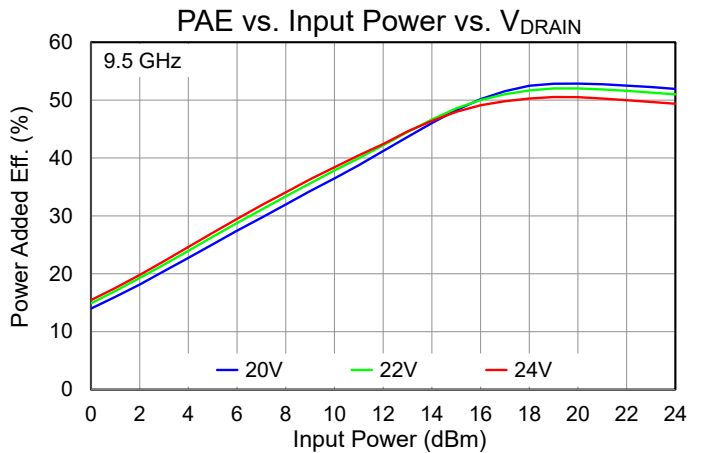
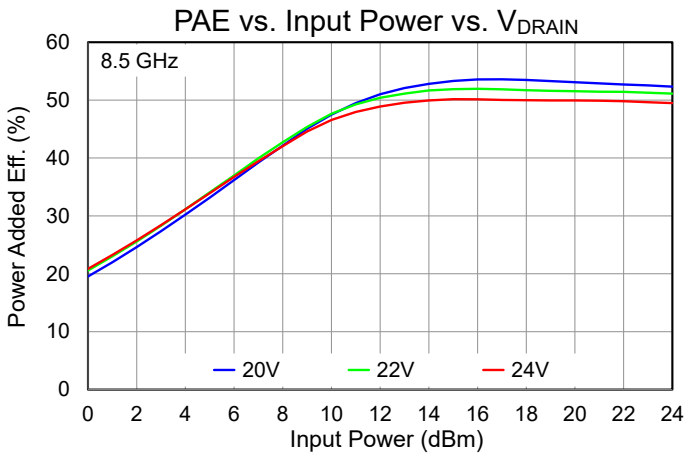
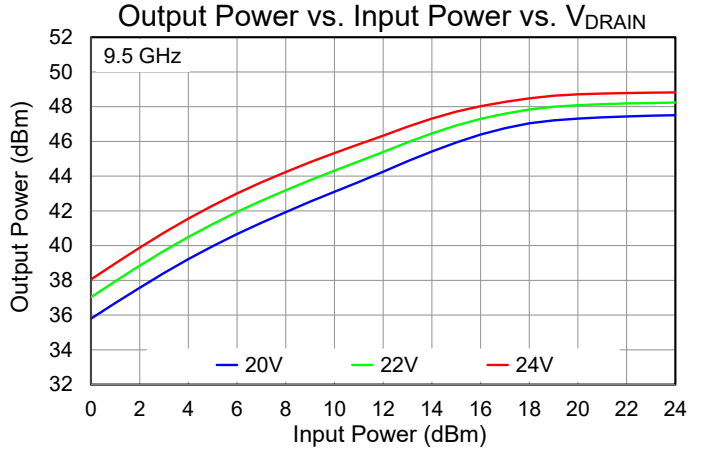
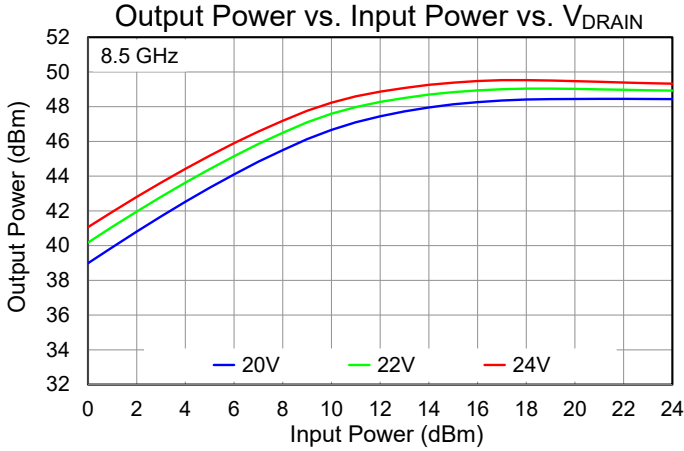

Performance Plots – Large Signal (Pulsed)

Test conditions, unless otherwise noted: $T = 25\text{ }^{\circ}\text{C}$, $I_{DQ} = 1.24\text{ A}$, $PW = 100\text{ }\mu\text{s}$, Duty Cycle = 10%

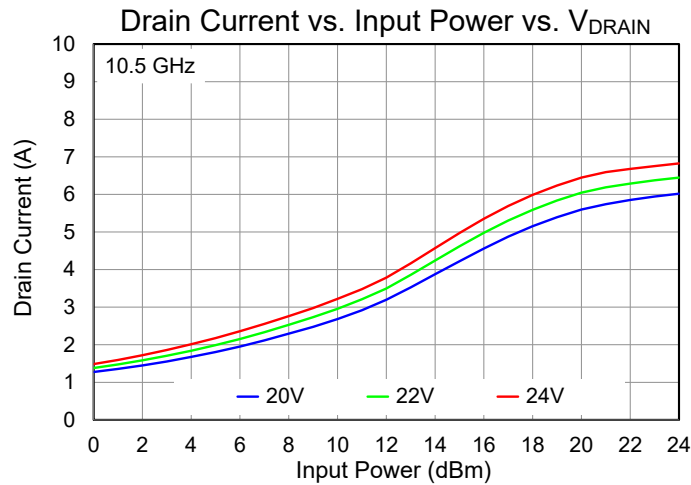
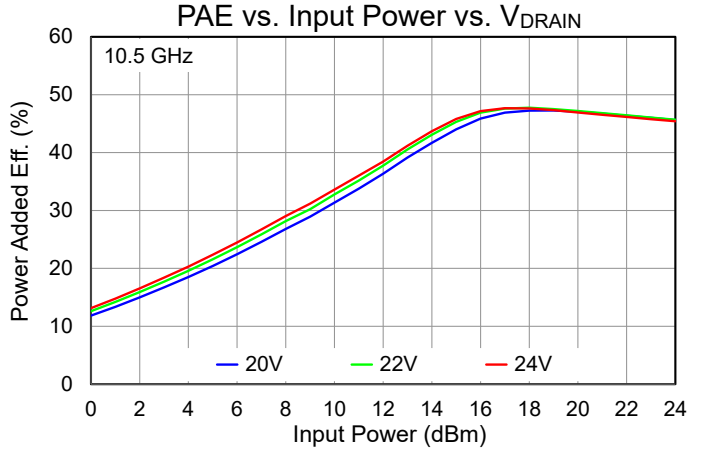
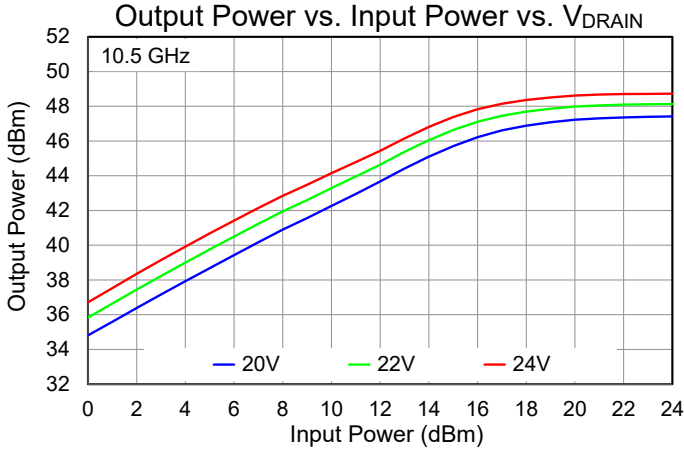

Performance Plots – Large Signal (Pulsed)

Test conditions, unless otherwise noted: $T = 25\text{ }^{\circ}\text{C}$, $V_D = 24\text{ V}$, $I_{DQ} = 1.24\text{ A}$, $P_{IN} = 21\text{ dBm}$

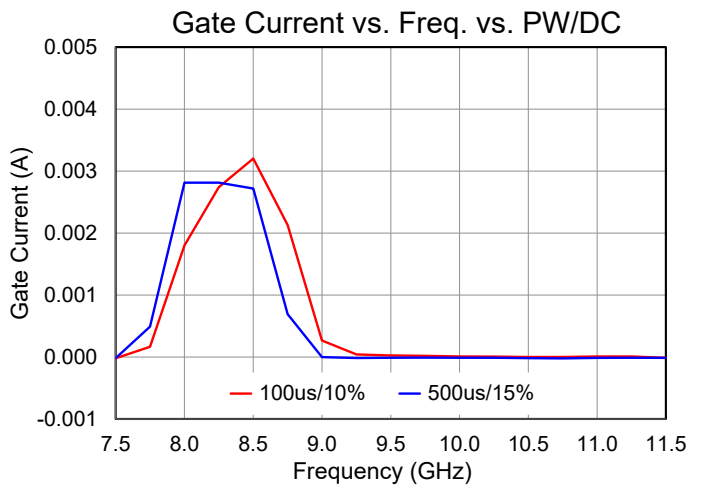
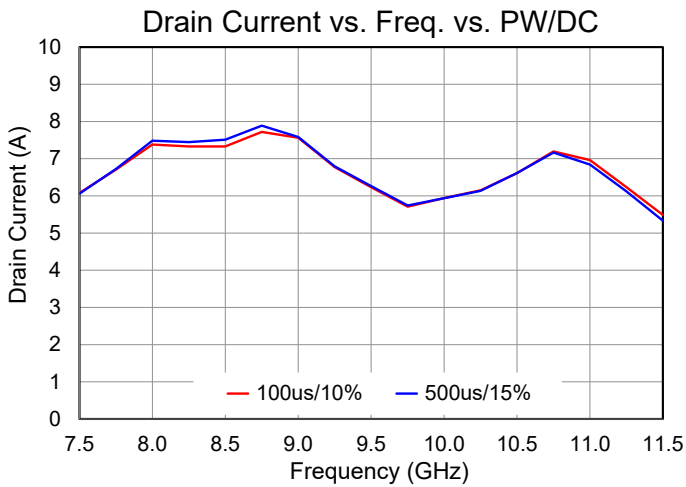
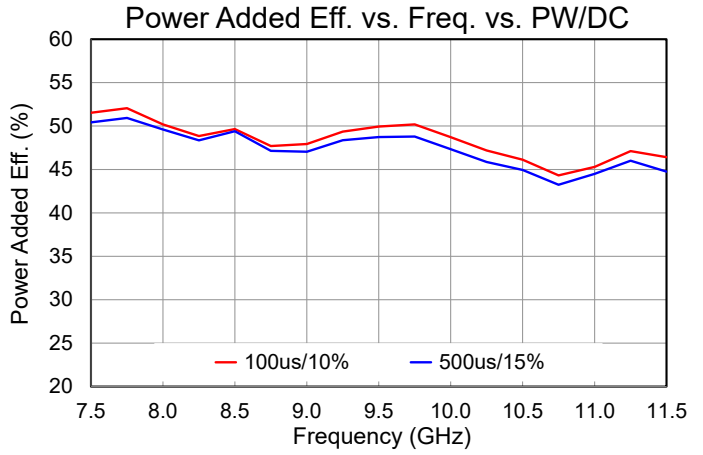
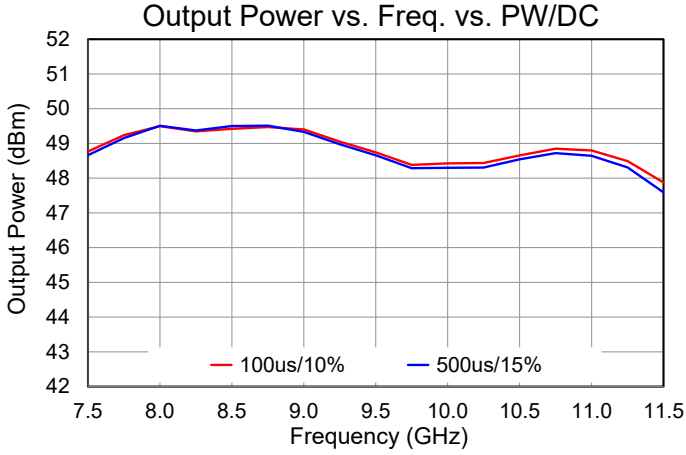

Performance Plots – Harmonics

Test conditions, unless otherwise noted: $I_{DQ} = 1.24$ A, $PW = 100$ us, Duty Cycle = 10%

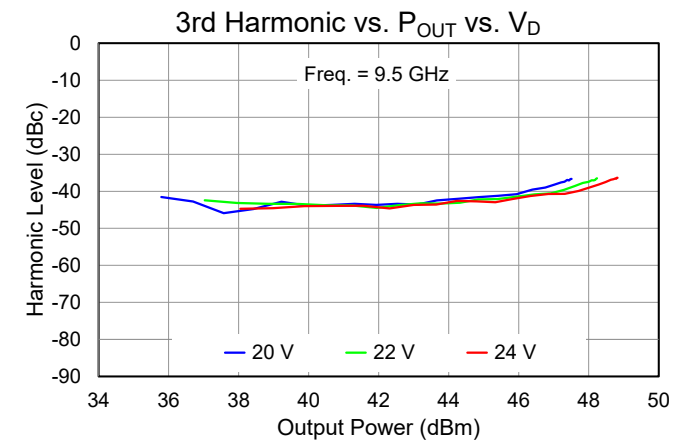
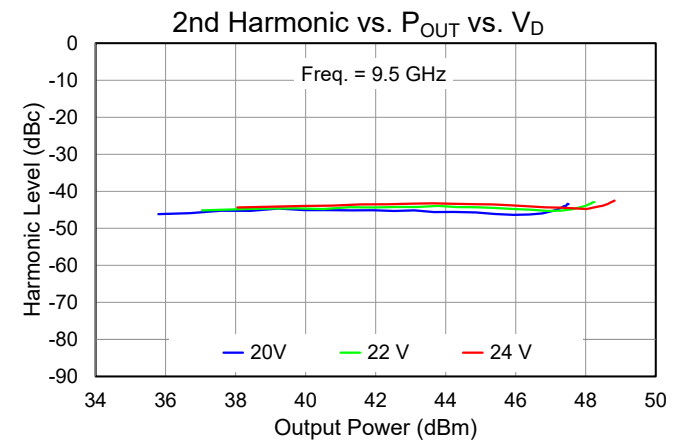
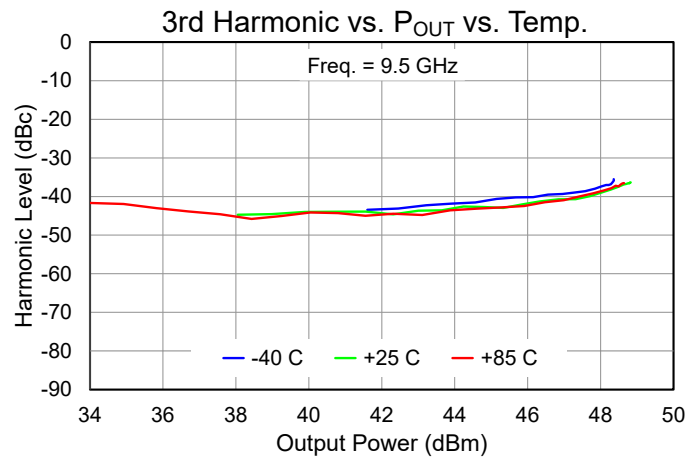
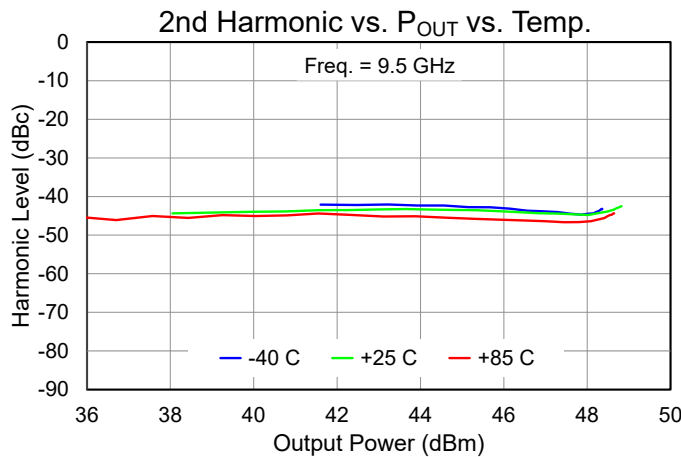
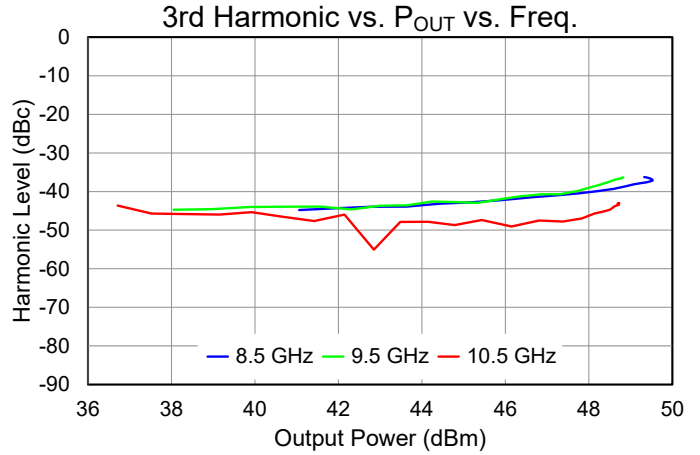
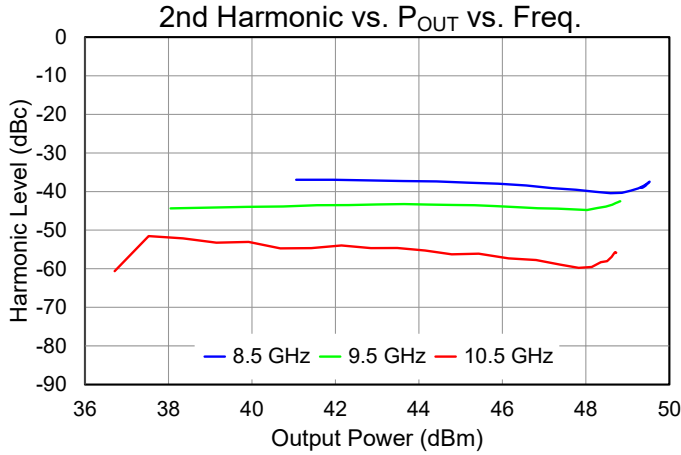

Performance Plots – Small Signal

Test conditions, unless otherwise noted: T = 25 °C, V_D = 24 V, I_{DQ} = 1.24 A, PW = 100 us, Duty Cycle = 10%

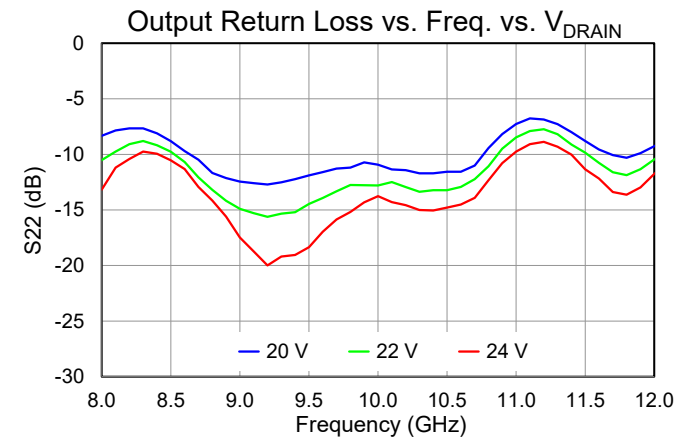
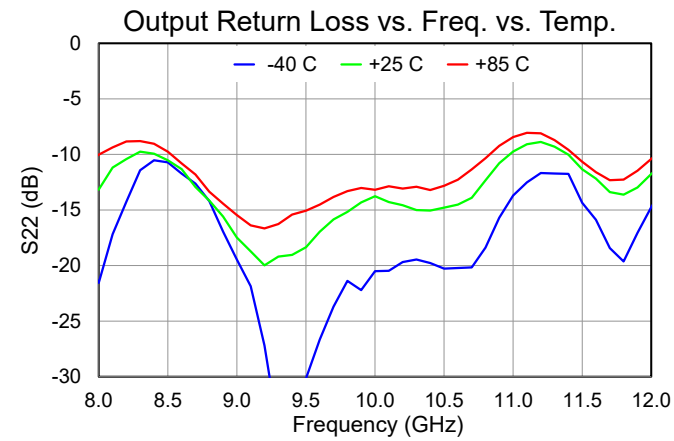
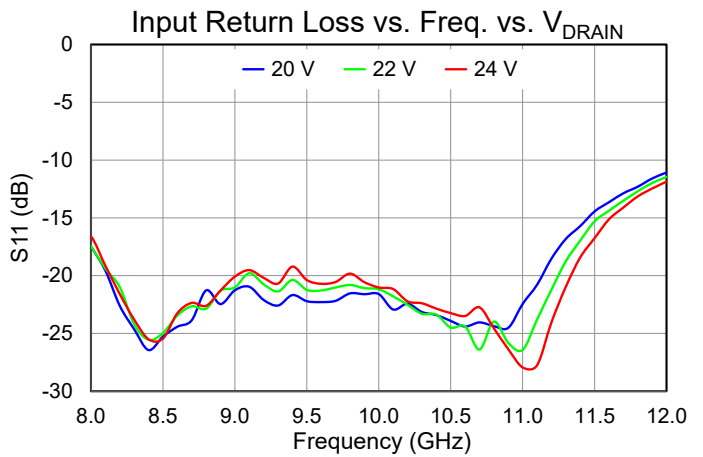
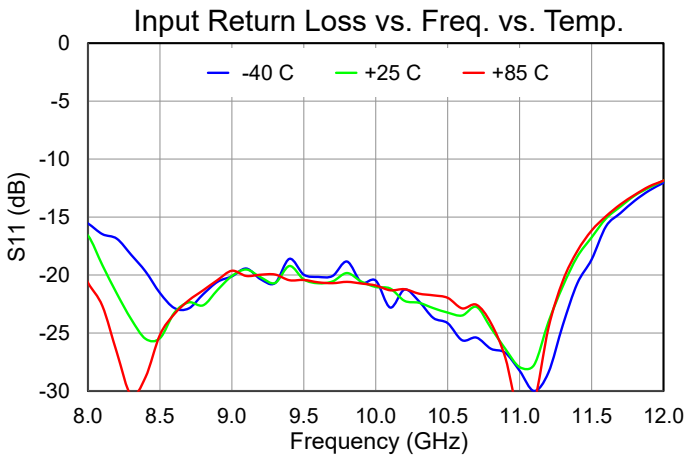
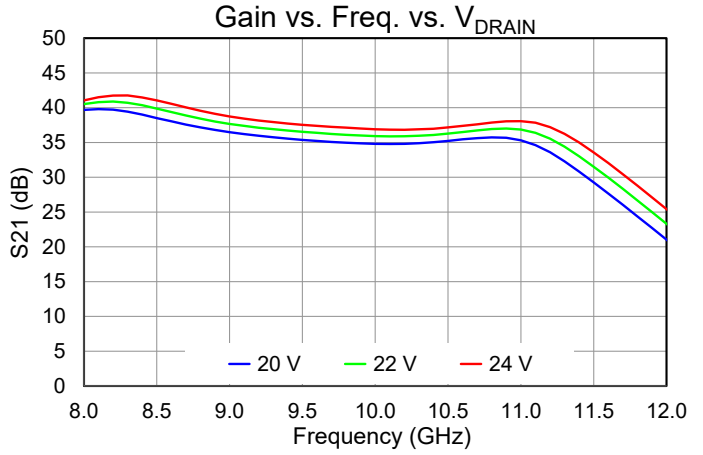
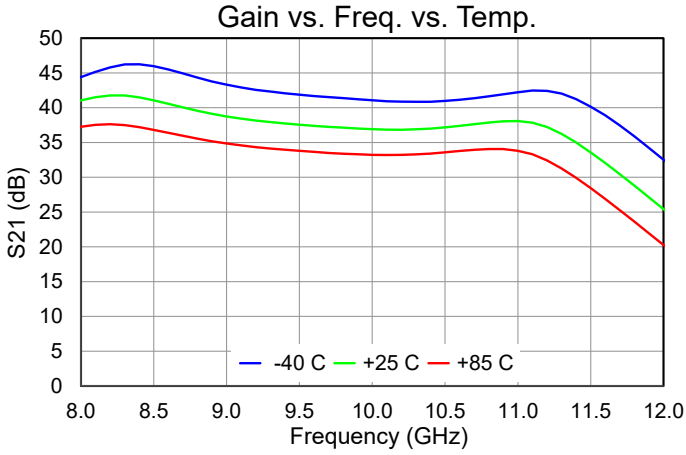

Performance Plots – Small Signal

Test conditions, unless otherwise noted: T = 25 °C, V_D = 24 V, I_{DQ} = 1.24 A, PW = 100 us, Duty Cycle = 10%

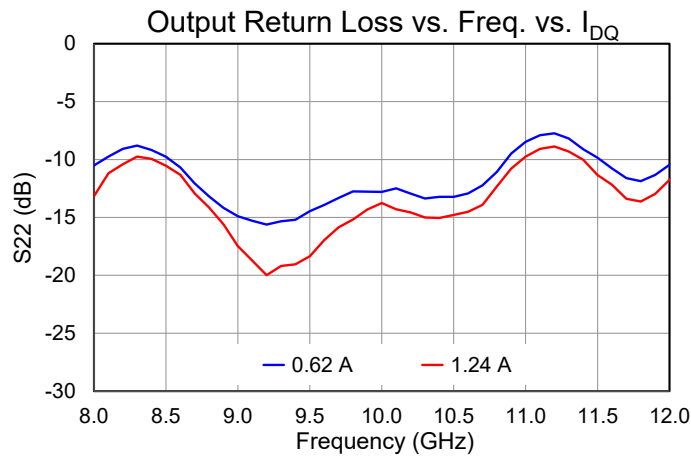
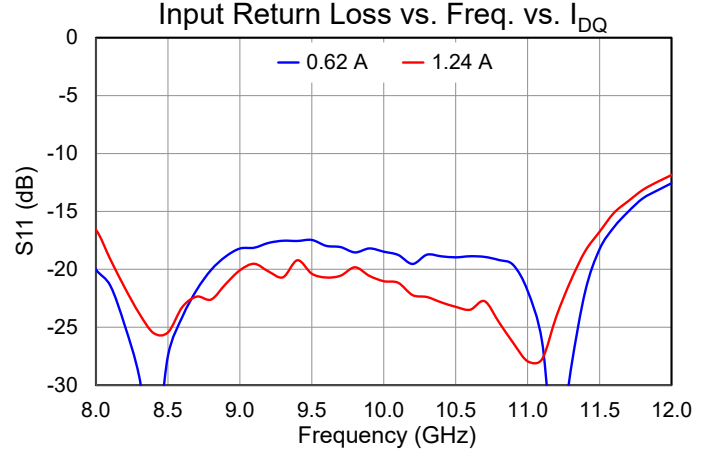
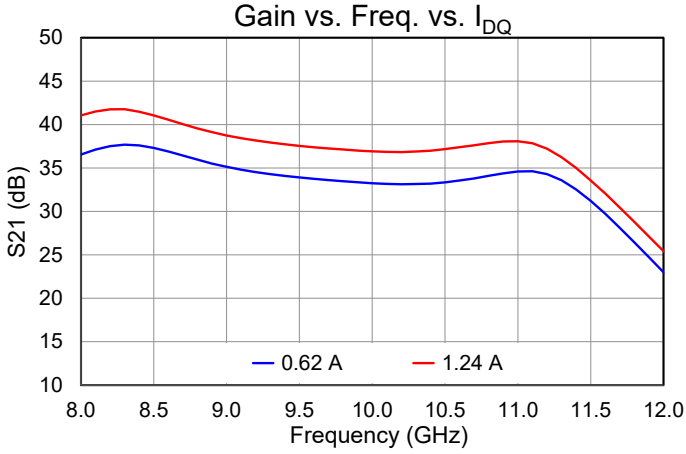

Thermal and Reliability Information

Parameter	Test Conditions	Value	Units
Thermal Resistance (θ_{JC}) ⁽¹⁾	$T_{base} = 85\text{ }^{\circ}\text{C}$, $V_D = 24\text{ V}$, $I_{DQ} = 1.24\text{ A}$, $P_{DISS} = 29.76\text{ W}$ (No RF Drive)	1.038	$^{\circ}\text{C/W}$
Channel Temperature, T_{CH} (No RF drive) ⁽²⁾		115.9	$^{\circ}\text{C}$
Thermal Resistance (θ_{JC}) ⁽¹⁾	Pulsed, $T_{base} = 85\text{ }^{\circ}\text{C}$, $V_D = 24\text{ V}$, $I_{DQ} = 1.24\text{ A}$, Freq. = 8.75 GHz, $P_{IN} = 24\text{ dBm}$, $P_{OUT} = 49.37\text{ dBm}$, $I_{D_DRIVE} = 7.82\text{ A}$, $P_{DISS} = 101.5\text{ W}$, $PW = 100\text{ }\mu\text{s}$, $DC = 10\%$ (Under Drive)	0.680	$^{\circ}\text{C/W}$
Channel Temperature, T_{CH} (w/RF drive) ⁽²⁾		154.0	$^{\circ}\text{C}$
Thermal Resistance (θ_{JC}) ⁽¹⁾	Pulsed, $T_{base} = 85\text{ }^{\circ}\text{C}$, $V_D = 24\text{ V}$, $I_{DQ} = 1.24\text{ A}$, Freq. = 8.75 GHz, $P_{IN} = 24\text{ dBm}$, $P_{OUT} = 49.30\text{ dBm}$, $I_{D_DRIVE} = 7.72\text{ A}$, $P_{DISS} = 100.4\text{ W}$, $PW = 500\text{ }\mu\text{s}$, $DC = 15\%$ (Under Drive)	0.973	$^{\circ}\text{C/W}$
Channel Temperature, T_{CH} (w/RF drive) ⁽²⁾		182.6	$^{\circ}\text{C}$

Notes:

- Thermal resistance determined to the back of the package (fixed at 85 $^{\circ}\text{C}$)
- IR scan equivalent. Refer to the following document: [GaN Device Channel Temperature, Thermal Resistance, and Reliability Estimates](#)

Dissipated Power and Maximum Gate Current

Test conditions, unless otherwise noted: $V_D = 24\text{ V}$, $I_{DQ} = 1.24\text{ A}$, $P_{IN} = 24\text{ dBm}$, $PW = 100\text{ }\mu\text{s}$, Duty Cycle = 10%

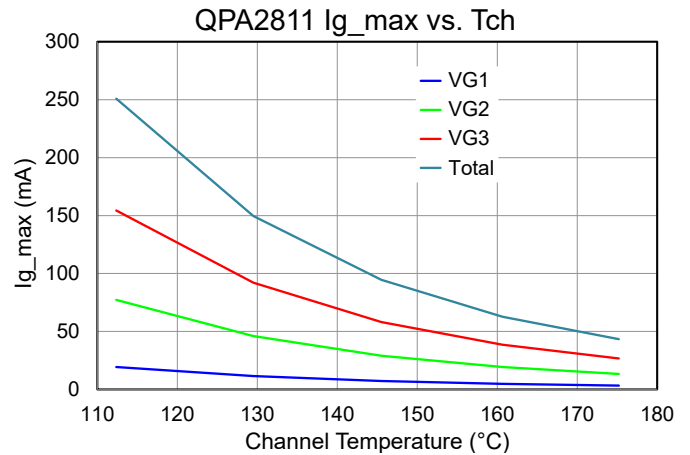
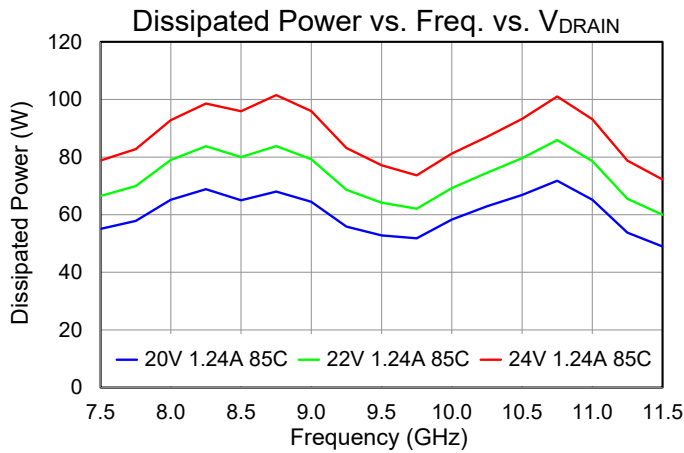

Applications Information

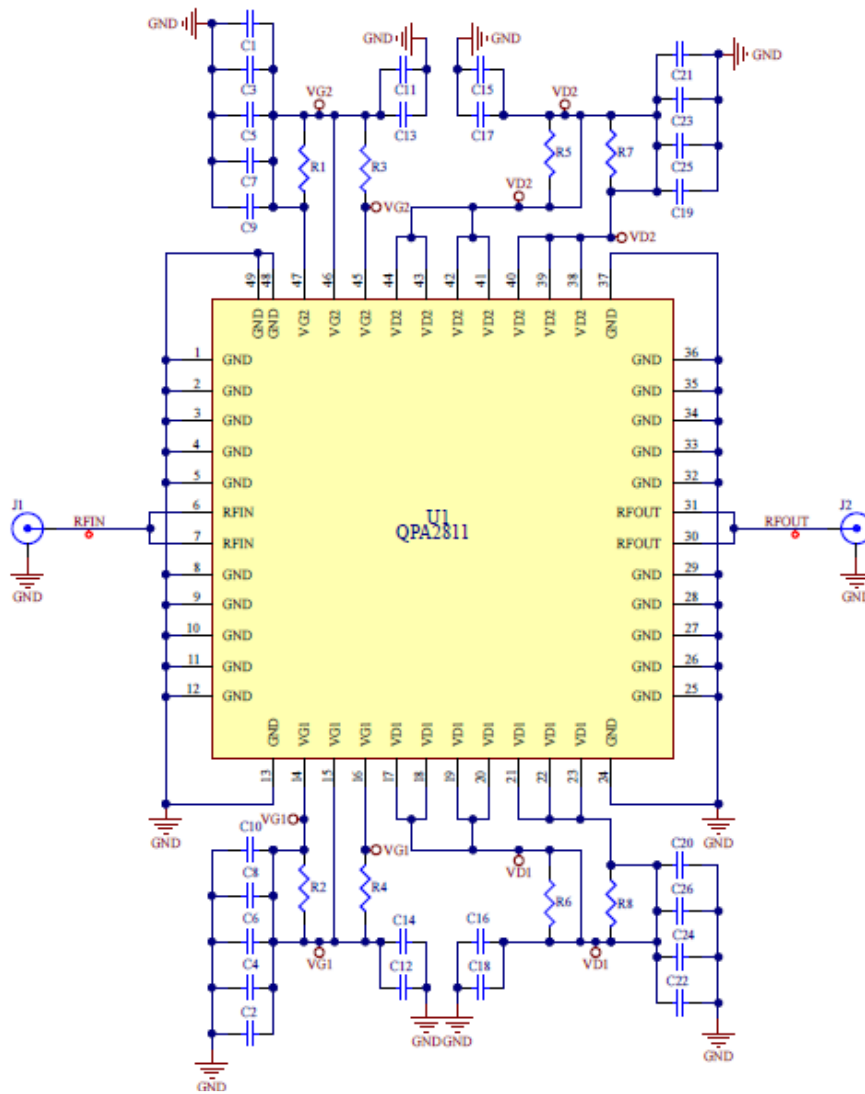

Notes:

1. V_G & V_D must be biased from both sides.

Bill of Materials

Reference Des.	Value	Description	Manuf.	Part Number
C1,C2	10 uF	CAP, 10uF, ±10%, 16V, X7R, 0805	Various	
C3,C4,C7,C8	1 uF	CAP, 1uF, 10%, 50V, X5R, 0603	Various	
C5,C6,C9,C10,C25,C26	0.1 uF	CAP, 0.1uF,10%, 50V, X7R, 0402	Various	
R1,R2,R3,R4,R5,R6,R7,R8	0 Ohm	RES, 0 OHM, 1/10W, 0402	Various	
J1, J2	2.92 mm	Female End Launch Connector	Southwest Microwave	1092-01A-12

Evaluation Board (EVB) Layout Assembly

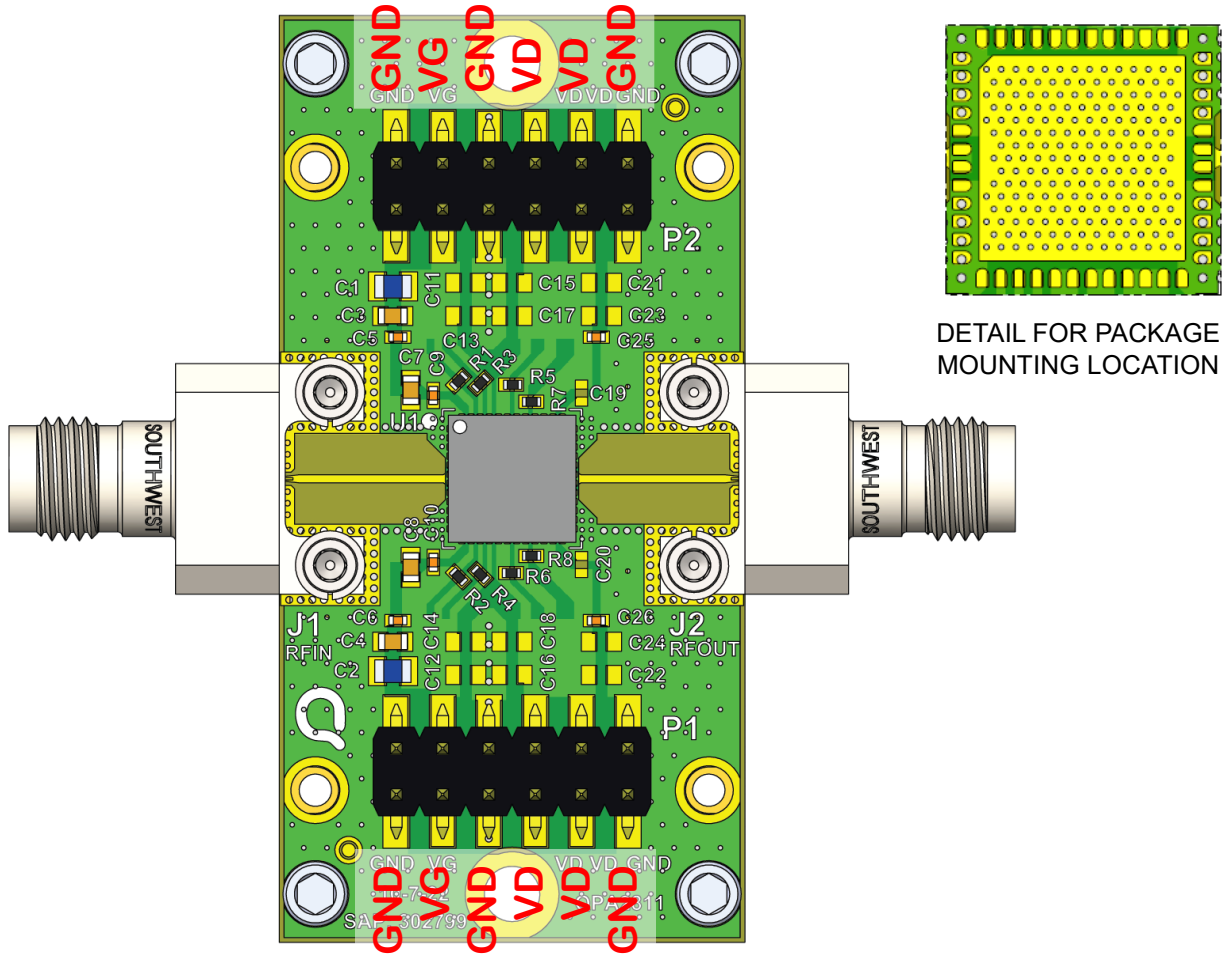

RF PCB is Rogers 4003C, 0.008" thick, 0.5 ounce copper on both sides.
PCB is a single layer board with high density thermal vias in the canter pad for improved thermal conductivity.

Bias-Up Procedure

1. Set I_D (peak) supply limit to 8000 mA, I_G supply limit to 60 mA
2. Set V_G to -4.0 V
3. Set V_D +24 V
4. Adjust V_G more positive until $I_{DQ} \approx 1.24$ A (peak)
5. Apply RF signal

Bias-Down Procedure

1. Turn off RF signal
2. Reduce V_G to -4.0 V. Ensure $I_{DQ} \sim 0$ mA
3. Set V_D to 0 V
4. Turn off V_D supply
5. Turn off V_G supply

QPA2811 Biasing Solution with ACT43750

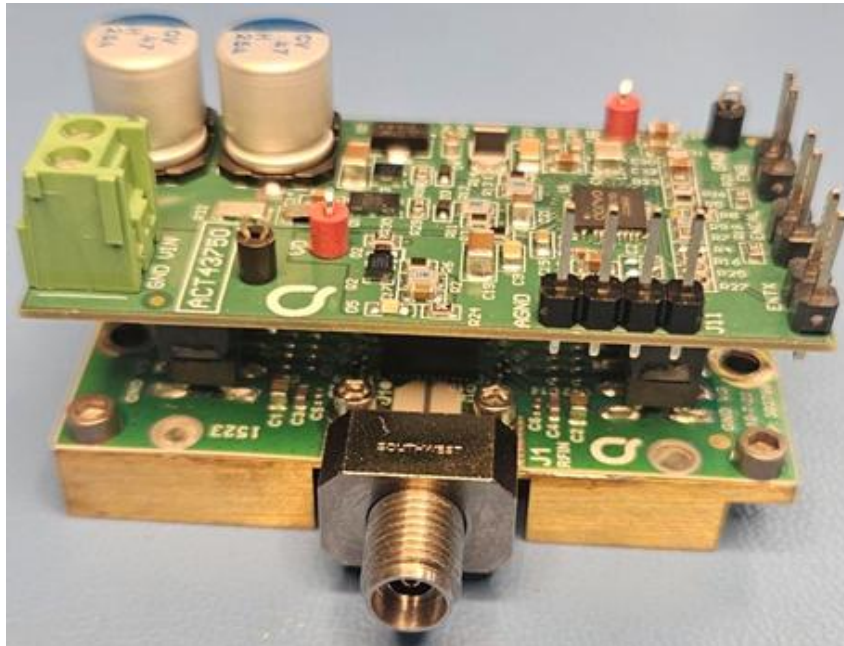

The QPA2811 Evaluation Board (EVB) can come with Qorvo’s advanced ACT43750 bias controller (QPA2811PCK01), providing a robust and flexible biasing solution. The ACT43750 autonomously manages both gate and drain bias sequencing, ensuring safe and repeatable startup and shutdown of the QPA2811 in continuous wave (CW) and pulsed RF applications, making it ideal for a wide range of radar, communications, and test applications.

- **Precision Bias Control:**
The ACT43750 delivers accurate drain current (IDQ) setting and pulsing control if needed. Its autonomous calibration ensures consistent amplifier performance across varying operating conditions.
- **Seamless Integration:**
The bias controller board is designed for direct plug-in to the QPA2811 EVB, minimizing setup time and eliminating the need for external biasing circuits. This simplifies system development and reduces risk of biasing errors.
- **User-Friendly Operation:**
Full control and monitoring of the amplifier bias are available through a PC-based GUI, enabling real-time adjustment, diagnostics, and data logging. The intuitive interface accelerates evaluation and prototyping workflows.
- **Comprehensive Protection:**
The ACT43750 provides built-in protection against overcurrent, overvoltage, and improper sequencing, safeguarding both the QPA2811 and the system during operation and test.

For detailed controller kit user instruction, reference designs and GUI user guide, refer to [ACT43750 Bias Controller Kit Applications and User Guide](#).

Mechanical Information and Pad Description

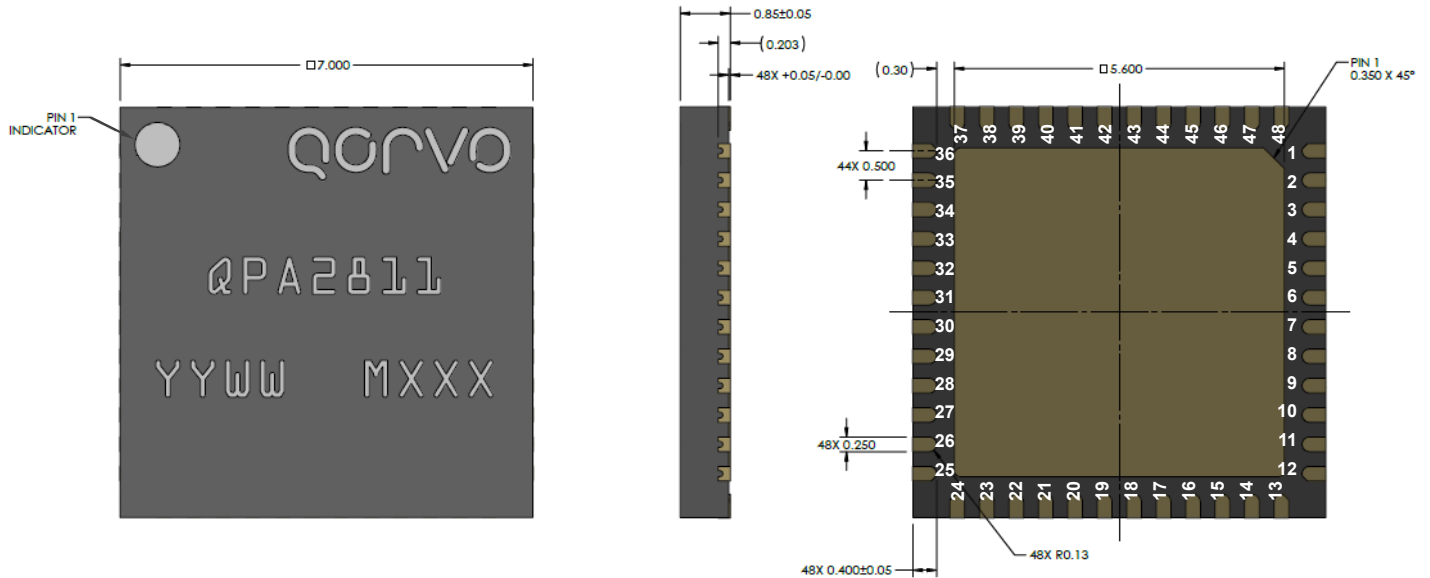

Unless otherwise specified, all dimensions are in mm.

Package leads are gold plated.

Part is mold encapsulated.

Tolerances:

.XX = ± 0.25

.XXX = ± 0.100

.XXXX = ± 0.0254

Bond Pad Description

Pad No.	Symbol	Description
1-5, 8-13, 24-29, 32-37, 48, 49 (Center Pad)	GND	Grounding these pins required. Center pad must be grounded to PCB
6, 7	RF INPUT	RF Input; matched to 50 Ω; DC grounded
14, 47	VG1	Gate voltage, stage 1. Bias network is required; see Application Circuit as an example (must be biased from both sides)
15, 46	VG2	Gate voltage, stage 2. Bias network is required; see Application Circuit as an example (must be biased from both sides)
16, 45	VG3	Gate voltage, stage 2. Bias network is required; see Application Circuit as an example (must be biased from both sides)
17-18, 43-44	VD1	Drain voltage, stage 1. Bias network is required; see Application Circuit as an example (must be biased from both sides)
19-20, 41-42	VD2	Drain voltage, stage 2. Bias network is required; see Application Circuit as an example (must be biased from both sides)
21-23, 38-40	VD3	Drain voltage, stage 2. Bias network is required; see Application Circuit as an example (must be biased from both sides)
30-31	RF OUTPUT	RF Output; matched to 50 Ω; DC grounded

Solderability

Compatible with the latest version of J-STD-020 Lead-free solder, 260 °C.

Assembly Notes

Compatible with lead-free soldering processes with 260°C peak reflow temperature.

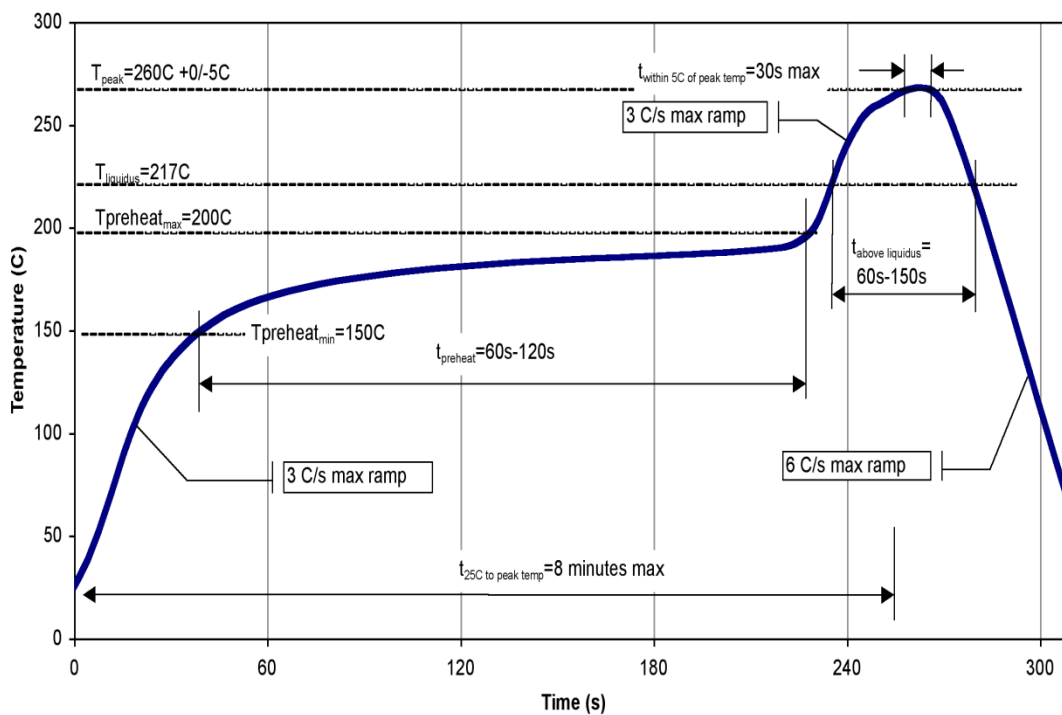

Recommended Soldering Temperature Profile

Tape and Reel Information – Carrier and Cover Tape Dimensions

Tape and reel specifications for this part are also available on the Qorvo website.
Standard T/R size = 250 pieces on a 7" reel.

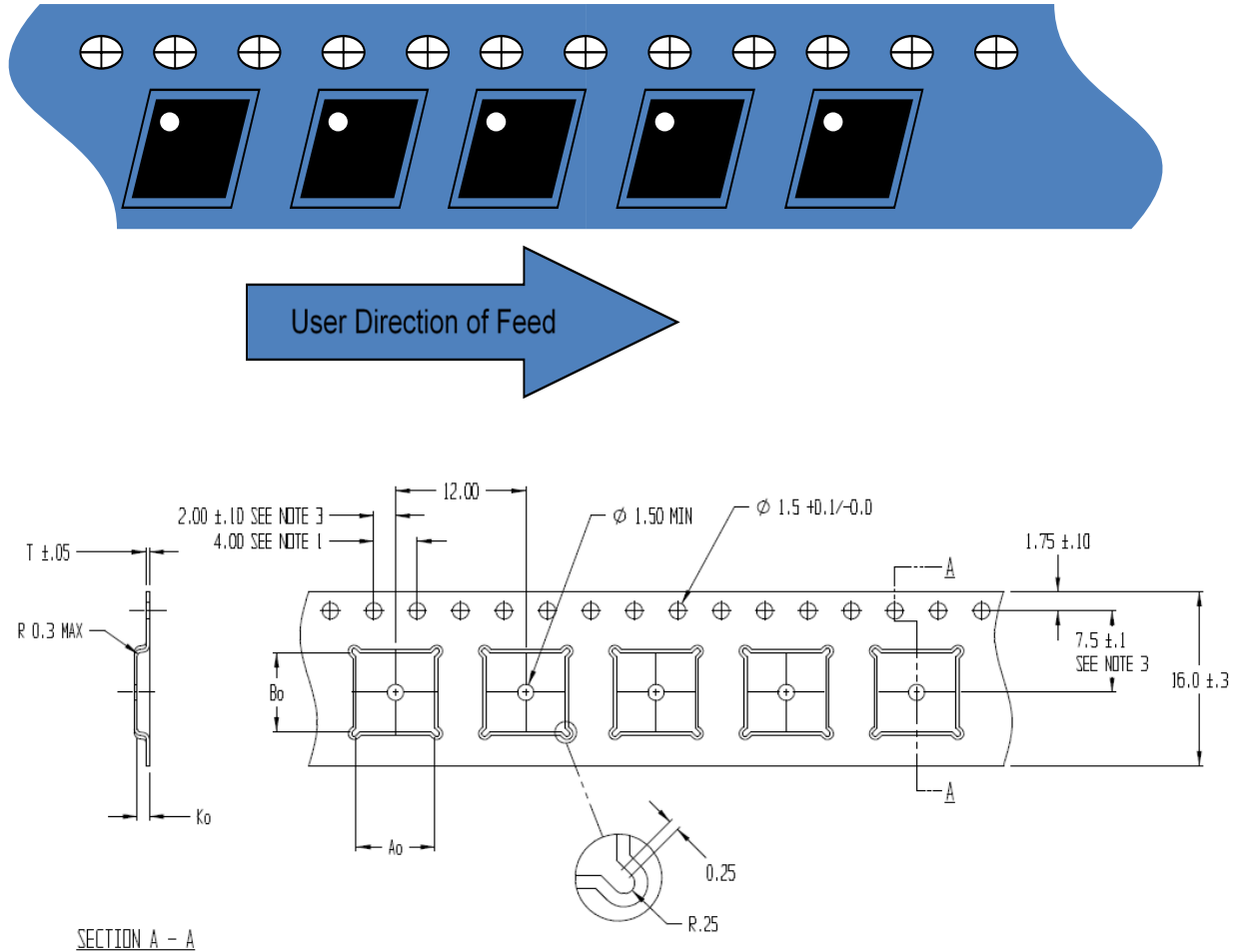

Feature	Measure	Symbol	Size (in)	Size (mm)
Cavity	Length	A0	0.285	7.25
	Width	B0	0.285	7.25
	Depth	K0	0.043	1.10
	Pitch	P1	0.472	12.00
Centerline Distance	Cavity to Perforation - Length Direction	P2	0.079	2.00
	Cavity to Perforation - Width Direction	F	0.295	7.50
Cover Tape	Width	C	0.524	13.30
Carrier Tape	Width	W	0.630	16.00

Tape and Reel Information – Reel Dimensions

Packaging reels are used to prevent damage to devices during shipping and storage, loaded carrier tape is typically wound onto a plastic take-up reel. The reel size is 7" diameter. The reels are made from high-impact injection-molded polystyrene (HIPS), which offers mechanical and ESD protection to packaged devices.

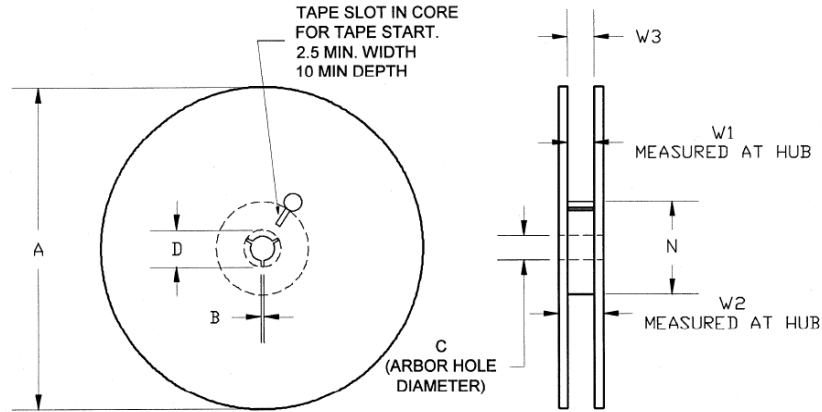

Feature	Measure	Symbol	Size (in)	Size (mm)
Flange	Diameter	A	6.969	177.0
	Thickness	W2	0.724	18.4
	Space Between Flange	W1	0.488	12.4
Hub	Outer Diameter	N	2.283	58.0
	Arbor Hole Diameter	C	0.512	13.0
	Key Slit Width	B	0.079	2.0
	Key Slit Diameter	D	0.795	20.2

Tape and Reel Information – Tape Length and Label Placement

Tape and reel specifications for this part are also available on the Qorvo website. Standard T/R size = 250 pieces on a 7" reel.

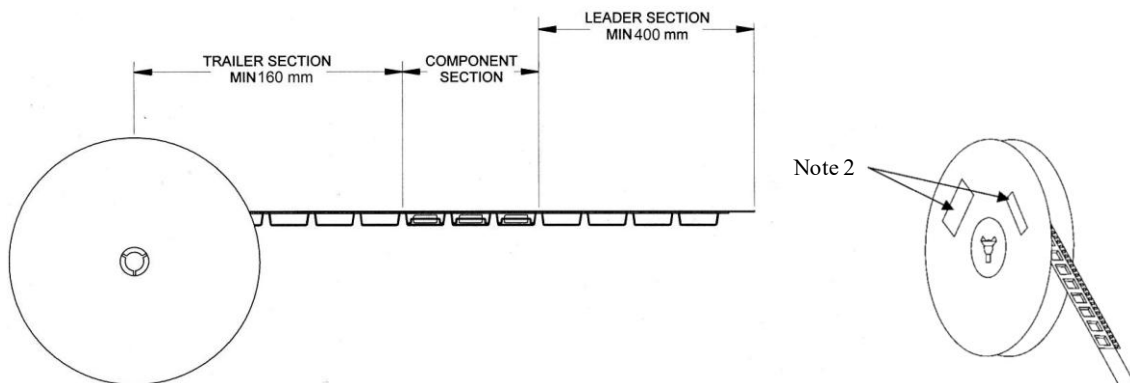

Notes:

1. Empty part cavities at the trailing and leading ends are sealed with cover tape. See EIA 481.
2. Labels are placed on the flange opposite the sprockets in the carrier tape.

Handling Precautions

Parameter	Rating	Standard
ESD – Human Body Model (HBM)	Class 1a	ANSI/ESDA/JEDEC JS-001
ESD – Charge Device Model (CDM)	Class C3	ANSI/ESDA/JEDEC JS-002
MSL – Moisture Sensitivity Level	MSL3	IPC/JEDEC J-STD-020



Caution!
ESD-Sensitive Device

RoHS Compliance

This part is compliant with 2011/65/EU RoHS directive (Restrictions on the Use of Certain Hazardous Substances in Electrical and Electronic Equipment) as amended by Directive 2015/863/EU.

This product also has the following attributes:

- Lead Free
- Halogen Free (Chlorine, Bromine)
- Antimony Free
- TBBP-A (C₁₅H₁₂Br₄O₂) Free
- PFOS Free
- SVHC Free

Contact Information

For the latest specifications, additional product information, worldwide sales and distribution locations:

Web: www.qorvo.com

Tel: 1-844-890-8163

Email: customer.support@qorvo.com

Important Notice

The information contained in this Data Sheet and any associated documents (“Data Sheet Information”) is believed to be reliable; however, Qorvo makes no warranties regarding the Data Sheet Information and assumes no responsibility or liability whatsoever for the use of said information. All Data Sheet Information is subject to change without notice. Customers should obtain and verify the latest relevant Data Sheet Information before placing orders for Qorvo® products. Data Sheet Information or the use thereof does not grant, explicitly, implicitly or otherwise any rights or licenses to any third party with respect to patents or any other intellectual property whether with regard to such Data Sheet Information itself or anything described by such information.

DATA SHEET INFORMATION DOES NOT CONSTITUTE A WARRANTY WITH RESPECT TO THE PRODUCTS DESCRIBED HEREIN, AND QORVO HEREBY DISCLAIMS ANY AND ALL WARRANTIES WITH RESPECT TO SUCH PRODUCTS WHETHER EXPRESS OR IMPLIED BY LAW, COURSE OF DEALING, COURSE OF PERFORMANCE, USAGE OF TRADE OR OTHERWISE, INCLUDING THE IMPLIED WARRANTIES OF MERCHANTABILITY AND FITNESS FOR A PARTICULAR PURPOSE. Without limiting the generality of the foregoing, Qorvo® products are not warranted or authorized for use as critical components in medical, life-saving, or life-sustaining applications, or other applications where a failure would reasonably be expected to cause severe personal injury or death. Applications described in the Data Sheet Information are for illustrative purposes only. Customers are responsible for validating that a particular product described in the Data Sheet Information is suitable for use in a particular application.

© 2026 Qorvo US, Inc. All rights reserved. This document is subject to copyright laws in various jurisdictions worldwide and may not be reproduced or distributed, in whole or in part, without the express written consent of Qorvo US, Inc. | QORVO® is a registered trademark of Qorvo US, Inc.

Looking for pricing, stock, or lifecycle information?

Click below to explore more details on WIN SOURCE:

 [View QPA2811 on WIN SOURCE](#)

 [Qorvo US Inc. Information](#)

Optimize Your Supply Chain with WIN SOURCE Solutions

-  Global Sourcing Solution
-  Obsolete Management
-  Cost Control Management
-  Shortage Management
-  Alternative Solution
-  Excess Inventory Management