

# General Purpose AC/DC EMC/RFI Filter with High Attenuation Performance



- Rated currents from 1 to 30 A
- High performance filter attenuation
- High differential-mode attenuation
- Optional medical versions (B type)
- Optional safety versions (A type)
- Optional enhanced performance versions
- Optional overvoltage protection (Z type)



### Performance indicators

Attenuation performance



Rated current [A]

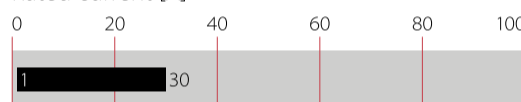

### Approvals & Compliances



### Features and Benefits

- FN 2030 filters are designed for easy and fast chassis mounting
- FN 2030 B versions without capacitors to earth comply to 1MOP for ME (medical equipment) acc. IEC 60601-1
- FN 2030 A versions with low capacitance to earth for safety critical applications with a requirement for low leakage currents
- FN 2030 filters offer an optimized filter range for high performance AC and DC applications, in same compact size (M, N1 types)
- All filters provide an exceptional conducted attenuation performance, based on chokes with high permeable core material and excellent thermal behavior
- The higher inductivity versus amperage offers increased attenuation performance with same form factor compared to FN 2010 and FN 2020 filter series
- All FN 2030 filters can be delivered with optional surge pulse protection (Z type).
- Various terminal options allow you to select the desired connection style

## Technical Specifications

<b>Maximum continuous operating voltage</b>	250 VAC, 50/60 Hz 250 VDC
<b>Nominal operating voltage</b>	230 VAC
<b>Rated currents</b>	1 to 30 A @ 40°C
<b>Operating frequency</b>	DC to 400 Hz
<b>High potential test voltage</b>	P → N 1100 VDC for 2 sec P → PE 2000 VAC for 2 sec (equiv. cap <88 nF) P → PE 2550 VDC for 2 sec (equiv. cap >88 nF) P → PE 2500 VAC for 2 sec (B types)
<b>Overvoltage category</b>	II acc. IEC 60664-1
<b>Pollution degree</b>	2 acc. IEC 60664-1
<b>Surge pulse protection (Z type)</b>	Helps compliance to IEC61000-4-5 (Differential Mode only)
<b>Temperature range (operation and storage)</b>	-25°C to +100°C (25/100/21)**
<b>Altitude</b>	2000m (above derating applies)**
<b>Flammability corresponding to</b>	Laces for -07 version: UL 94 VW-1 Terminal plastic for -06/-08 version: UL 94 V-0 Grommet for -07 version: UL 94 V-0
<b>Certified to</b>	UL 1283, CSA 22.2 No. 8 1986, IEC/EN 60939 (applies to AC and DC applications)
<b>MTBF (Mil-HB-217F)</b>	≤10 A: >2,200,000 h @ 40°C/230 V ≥12 A: >1,200,000 h @ 40°C/230 V

\* maximum RMS operating voltage at rated frequency or the maximum DC operating voltage  
 \*\* for dedicated requests exceeding this specification (e.g. -40 °C or higher altitude) please contact your local Schaffner Sales office







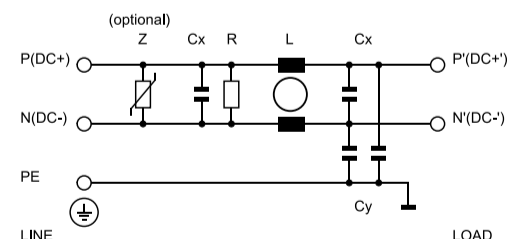



































## Typical Applications

- Electrical and electronic equipment
- Consumer goods
- Household equipment
- Medical equipment
- Electronic data processing equipment
- Office automation and datacom equipment
- Various noisy applications requiring high filter performance

### Typical electrical schematic



## Filter Selection Table

Filter*	Buy	Rated current @ 40°C (25°C) [A]	Leakage current** @ 250 VAC/50 Hz (@ 120 VAC/60 Hz) [mA]	Power Loss @25°C/DC [W]	Inductance*** L [mH]	Capacitance***		Resistance*** R [kΩ]	Input/Output connections			Weight [g]
						Cx [μF]	Cy [nF]					
FN2030-1-..		1 (1.1)	0.31 (0.18)	0.9	20	0.22	2.2	1000	-06	-07		58
FN2030-3-..		3 (3.4)	0.47 (0.27)	2.2	14	0.33	3.3	1000	-06	-07		87
FN2030-4-..		4 (4.5)	0.47 (0.27)	2.9	14	0.33	3.3	1000	-06	-07		92
FN2030-6-..		6 (6.7)	0.66 (0.38)	3.2	8	0.47	4.7	680	-06	-07		100
FN2030-8-..		8 (8.9)	0.66 (0.38)	3.1	8	0.47	4.7	680	-06	-07		170
FN2030-10-..		10 (11.2)	0.66 (0.38)	5.3	8	0.47	4.7	680	-06	-07		196
FN2030-12-..		12 (13.4)	0.79 (0.45)	7.6	4	1.0	10	330	-06	-07		185
FN2030-16-..		16 (17.9)	0.79 (0.45)	6.1	4	1.0	10	330	-06	-07	-08	225
FN2030-20-..		20 (22.4)	0.79 (0.45)	4.6	4	1.0	10	330	-06		-08	285
FN2030-30-08		30 (33.5)	0.79 (0.45)	6.0	2	1.0	10	330			-08	326
<b>Enhanced performance</b>												
FN2030A-1-..		1 (1.1)	0.07 (0.04)	0.9	20	0.22	0.47	1000	-06	-07		58
FN2030A-3-..		3 (3.4)	0.07 (0.04)	2.2	14	0.33	0.47	1000	-06	-07		87
FN2030A-4-..		4 (4.5)	0.07 (0.04)	2.9	14	0.33	0.47	1000	-06	-07		92
FN2030A-6-..		6 (6.7)	0.07 (0.04)	3.2	8	0.47	0.47	680	-06	-07		100
FN2030A-8-..		8 (8.9)	0.07 (0.04)	3.1	8	0.47	0.47	680	-06	-07		170
FN2030A-10-..		10 (11.2)	0.07 (0.04)	5.3	8	0.47	0.47	680	-06	-07		196
FN2030A-12-..		12 (13.4)	0.07 (0.04)	7.6	4	1.0	0.47	330	-06	-07		185
FN2030A-16-..		16 (17.9)	0.07 (0.04)	6.1	4	1.0	0.47	330	-06	-07	-08	225
FN2030A-20-..		20 (22.4)	0.07 (0.04)	4.6	4	1.0	0.47	330	-06		-08	285
FN2030A-30-08		30 (33.5)	0.07 (0.04)	6.0	2	1.0	0.47	330			-08	326
<b>Enhanced performance</b>												
FN2030B-1-..		1 (1.1)	0.00	0.9	20	0.22		1000	-06	-07		58
FN2030B-3-..		3 (3.4)	0.00	2.2	14	0.33		1000	-06	-07		87
FN2030B-4-..		4 (4.5)	0.00	2.9	14	0.33		1000	-06	-07		92
FN2030B-6-..		6 (6.7)	0.00	3.2	8	0.47		680	-06	-07		100
FN2030B-8-..		8 (8.9)	0.00	3.1	8	0.47		680	-06	-07		170
FN2030B-10-..		10 (11.2)	0.00	5.3	8,45	0.47		680	-06	-07		196
FN2030B-12-..		12 (13.4)	0.00	7.6	4	1.0		330	-06	-07		185
FN2030B-16-..		16 (17.9)	0.00	6.1	4	1.0		330	-06	-07	-08	225
FN2030B-20-..		20 (22.4)	0.00	4.6	4	1.0		330	-06		-08	285
FN2030B-30-08		30 (33.5)	0.00	6.0	2	1.0		330			-08	326
<b>Enhanced performance</b>												
FN2030N1-1-06		1 (1.1)	5.34 (3.08)	0.9	20	0.22	68	1000	-06			65
FN2030M-3-06		3 (3.4)	3.69 (2.28)	2.2	14	0.33	47	1000	-06			110
FN2030M-4-06		4 (4.5)	3.69 (2.28)	2.9	14	0.33	47	1000	-06			110
FN2030M-6-06		6 (6.7)	3.69 (2.28)	3.2	8	0.47	47	680	-06			120
FN2030N1-8-06		8 (8.9)	5.34 (3.08)	3.1	8	0.47	68	3680	-06			200
FN2030N1-10-06		10 (11.2)	5.34 (3.08)	5.3	8	0.47	68	680	-06			200
FN2030N1-12-06		12 (13.4)	5.34 (3.08)	7.6	4	1.0	68	330	-06			210
FN2030M-16-..		16 (17.9)	3.69 (2.28)	6.1	4	1.0	47	330	-06		-08	265
FN2030M-20-..		20 (22.4)	3.69 (2.28)	4.6	4	1.0	47	330	-06		-08	326
FN2030M-30-08		30 (33.5)	3.69 (2.28)	6.0	2	1.0	47	330			-08	346

\* To compile a complete part number, please replace the -.. with the required I/O connection style. For surge pulse protection, please add Z (e.g. FN 2030Z-10-06, FN 2030BZ-20-08).

\*\* Maximum leakage under usual AC operating conditions (acc. IEC60939-3). Note: if the neutral line is interrupted, worst case leakage could reach twice this level.

\*\*\* Tolerances apply: Inductance: -30/+50%, Capacitance: ±20%, Resistance: ±10%



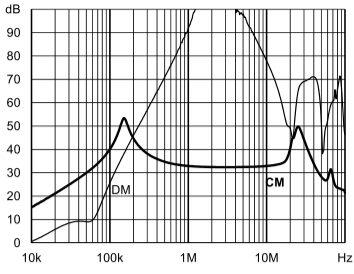

10 A: Standard type

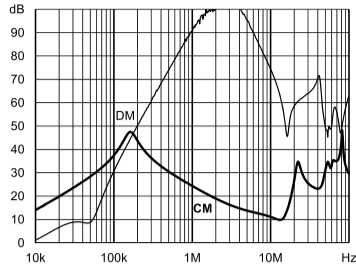

A type

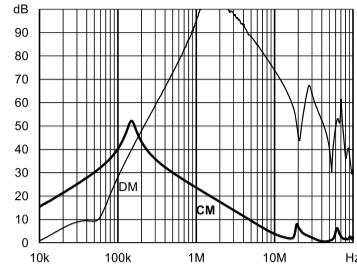

B type

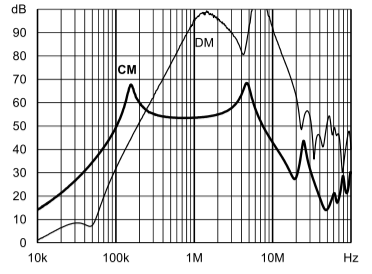

Enhanced performance

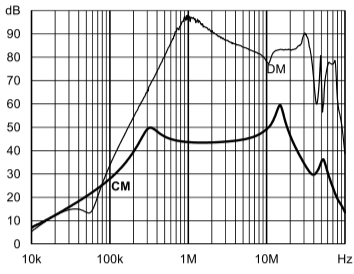

12 A: Standard type

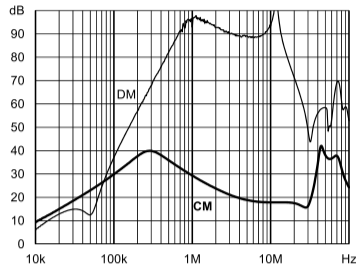

A type

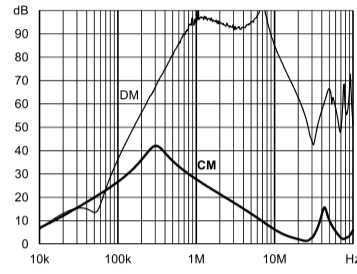

B type

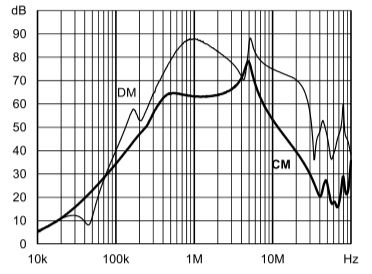

Enhanced performance

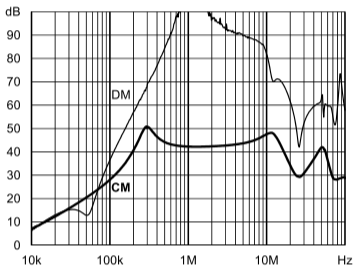

16 A: Standard type

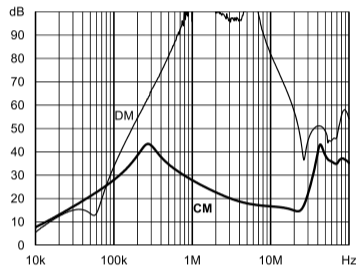

A type

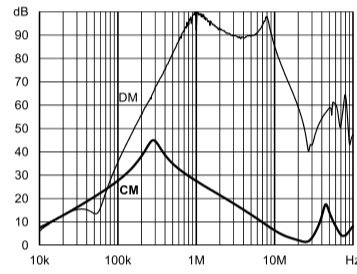

B type

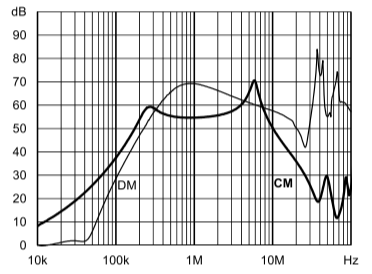

Enhanced performance

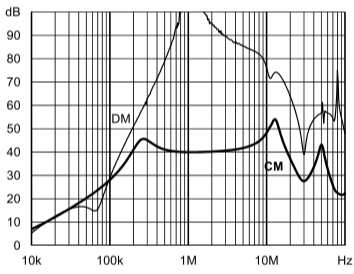

20 A: Standard type

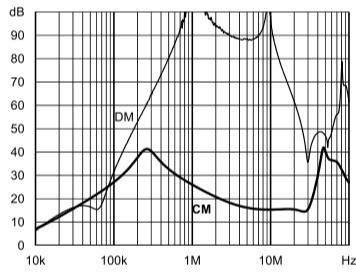

A type

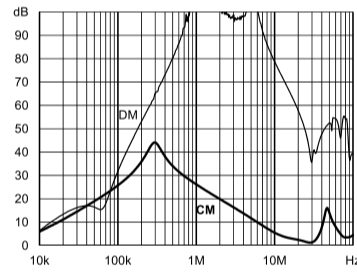

B type

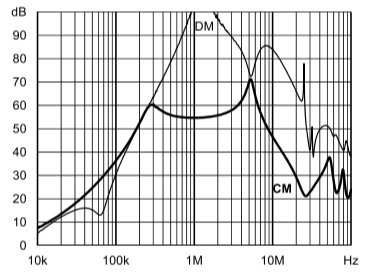

Enhanced performance

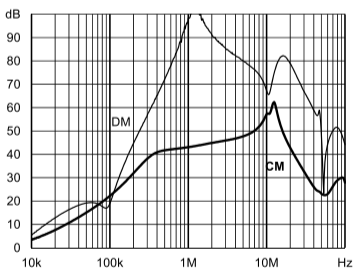

30 A: Standard type

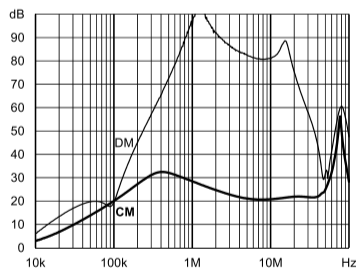

A type

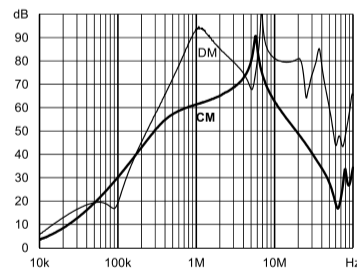

B type

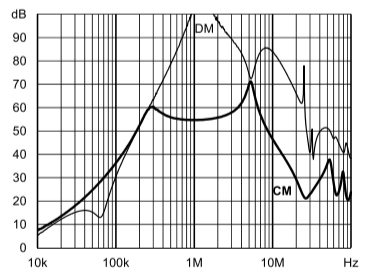

Enhanced performance

Product Selector		
FN 2030 xy-xx-yy		
06	Faston 6,3 × 0,8 mm (spade/soldering)	
07	Wire leads	
08	Studs (M4 screws)	
1 to 60	Rated current	
Blank	Standard version	
Z	With surge protection	
Blank	Standard version	
A	Safety version	
B	Medical version	
N1/M	High performance version	

### Mechanical data

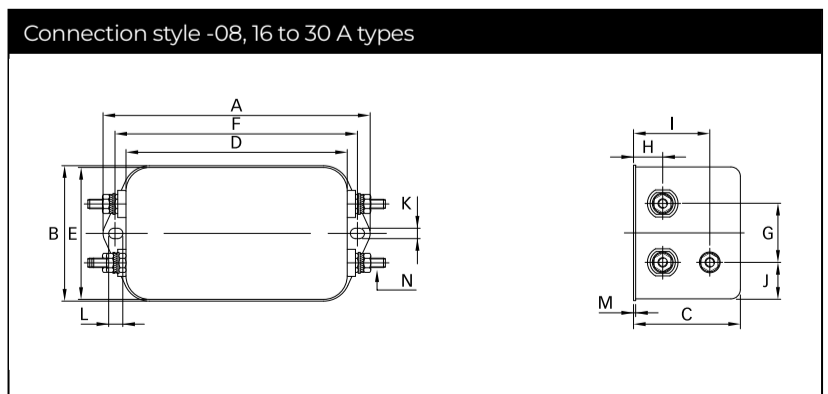
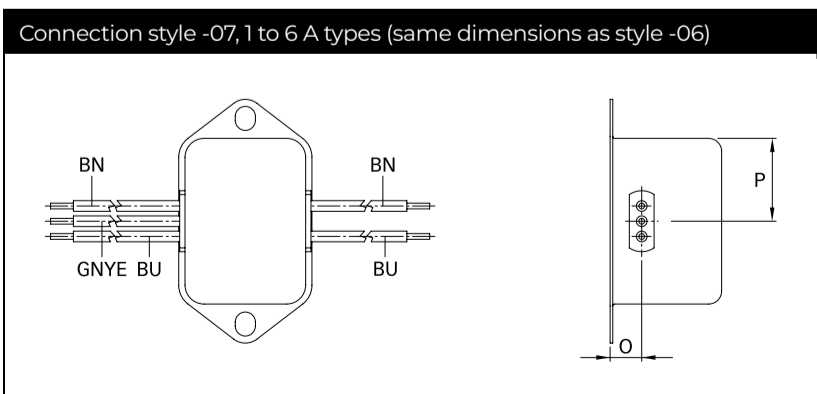
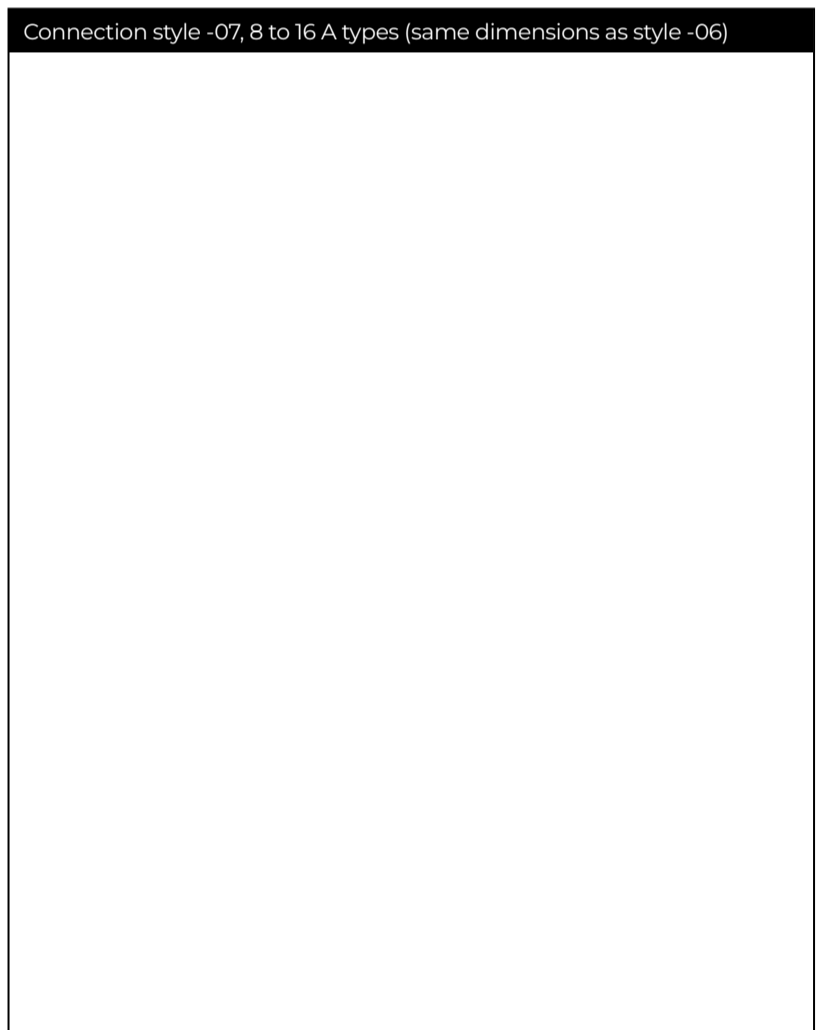
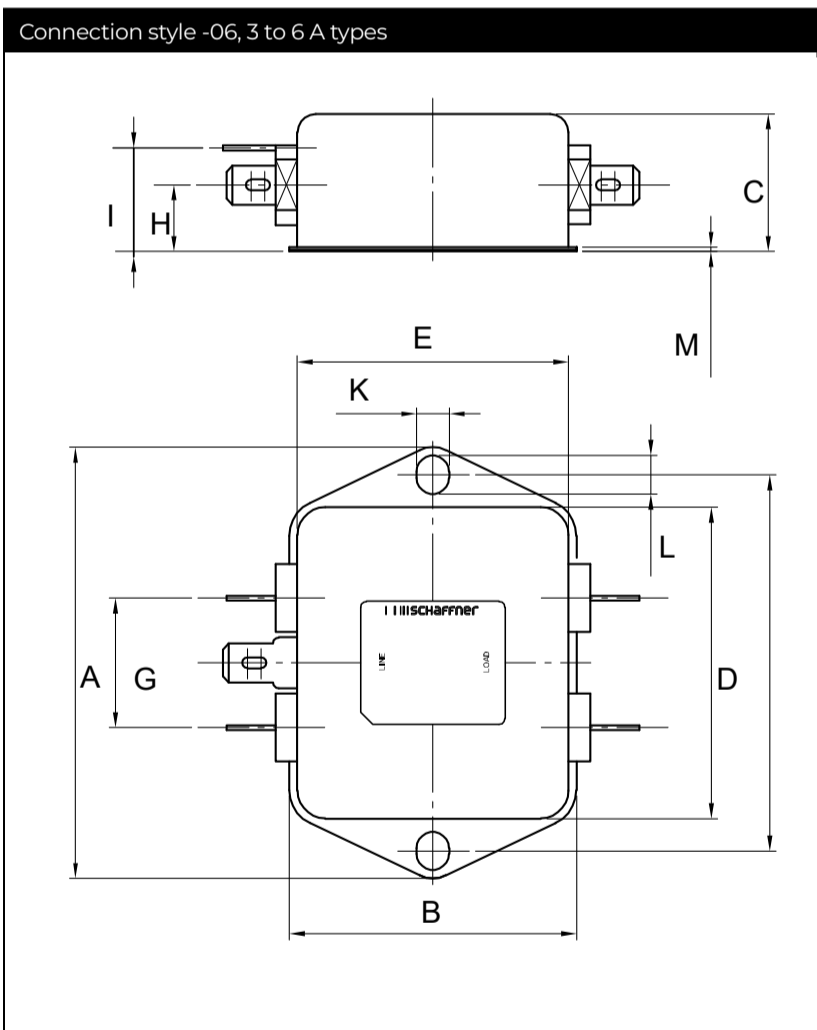
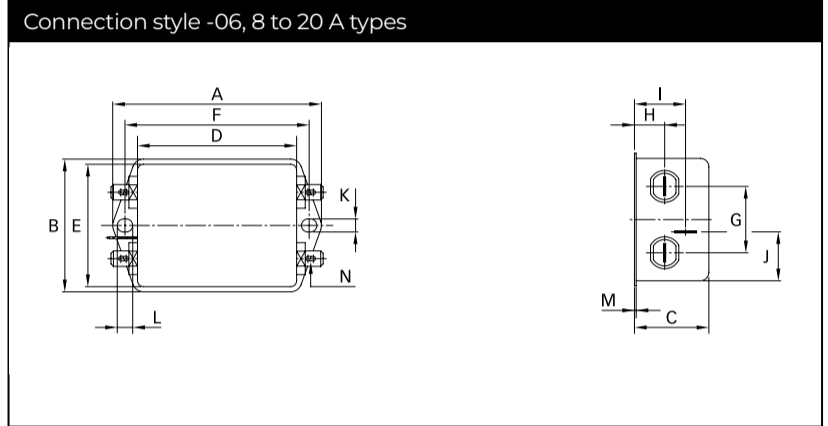
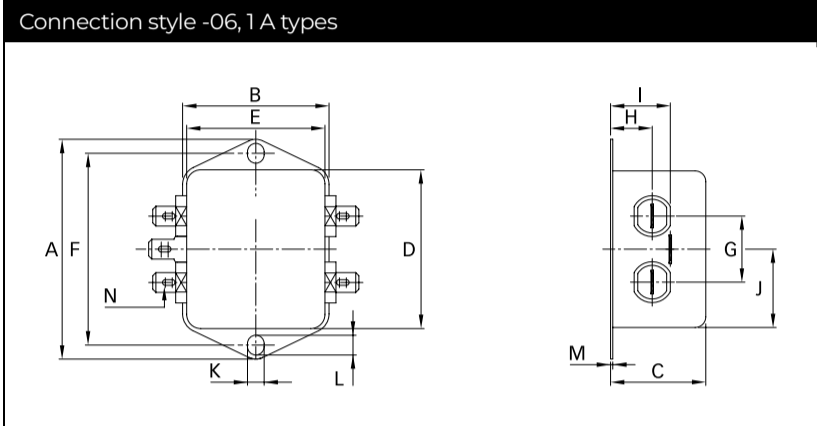

## Dimensions

	1 A	3 A	4 A	6 A	8 A	10 A	12 A	16 A	20 A	30 A	Tolerances
<b>A</b>	64	71	71	71	85	85	85	85	85	85	±0.5
<b>B</b>	35	46.6	46.6	46.6	54	54	54	54	54	54	±0.5
<b>C</b>	24.3	22.3	22.3	22.3	30.3	30.3	30.3	40.3	40.3	40.3	±0.5
<b>D</b>	43.5	50.5	50.5	50.5	64.8	64.8	64.8	64.8	64.8	64.8	±0.5
<b>E</b>	32.5	44.5	44.5	44.5	49.8	49.8	49.8	49.8	49.8	49.8	±0.5
<b>F</b>	54	61	61	61	75	75	75	75	75	75	±0.3
<b>G</b>	21	21	21	21	27	27	27	27	27	27	±0.2
<b>H</b>	9.3	10.8	10.8	10.8	12.3	12.3	12.3	12.3	12.3	12.3	±0.5
<b>I</b>	15.3	16.8	16.8	16.8	20.8	20.8	20.8	29.8	29.8	29.8	±0.5
<b>J</b>	21.8	25.25	25.25	25.25	19.9	19.9	19.9	11.4	11.4	11.4	±0.5
<b>K</b>	5.3	5.3	5.3	5.3	5.3	5.3	5.3	5.3	5.3	5.3	
<b>L</b>	6.3	6.3	6.3	6.3	6.3	6.3	6.3	6.3	6.3	6.3	
<b>M</b>	0.7	0.7	0.7	0.7	0.7	0.7	0.7	0.7	0.7	0.7	
<b>Connection style -06</b>											
<b>N</b>	6.3 x 0.8	6.3 x 0.8	6.3 x 0.8	6.3 x 0.8	6.3 x 0.8	6.3 x 0.8	6.3 x 0.8	6.3 x 0.8	6.3 x 0.8		
<b>Connection style -07</b>											
<b>O</b>	8.3	8.3	8.3	8.3	8.3	8.3	8.3	8.3			±0.5
<b>P</b>	21.8	14	14	14	14.9	14.9	14.9	14.9			±0.5
<b>AWG type wire</b>	AWG 20	AWG 20	AWG 20	AWG 18	AWG 18	AWG 18	AWG 16	AWG 16			
<b>Wire length</b>	140	140	140	140	140	140	140	140			+5
<b>Connection style -08</b>											
<b>N</b>								M4	M4	M4	
<b>Recommended torque (Nm)</b>								1.2 - 1.3	1.2 - 1.3	1.2 - 1.3	
<b>Earth terminal</b>								1.5 - 1.7	1.5 - 1.7	1.5 - 1.7	

All dimensions in mm; 1 inch = 25.4 mm

Tolerances according: ISO 2768-m/EN 22768-m

## We are here to help



Read more insights from TE's experts:

## Connect With Us

We make it easier to connect with our experts and are ready to provide the support you need. Visit [te.com/support](https://te.com/support) to chat with a Product Information Specialist.

## te.com

©2025 TE Connectivity plc. All Rights Reserved.

TE Connectivity, TE, TE connectivity (logo), and EVERY CONNECTION COUNTS, ECOSine, Schaffner are trademarks owned or licensed by TE Connectivity plc. family of companies. All other logos, products and/or company names referred to herein might be trademarks of their respective owners.

While TE has made every reasonable effort to ensure the accuracy of the information in this document, TE does not guarantee that it is error-free, nor does TE make any other representation, warranty or guarantee that the information is accurate, correct, reliable or current. TE reserves the right to make any changes to the information contained herein without prior notice. TE Connectivity assumes only those obligations set forth in the terms and conditions for this product and shall in no event be liable for any incidental, indirect, or consequential damages arising out of the sale, resale, use, or misapplication of the product. TE expressly disclaims any implied warranties with respect to the information contained herein, including, but not limited to, implied warranties of merchantability or fitness for a particular purpose. Dimensions, specifications and/or information contained herein are for reference purposes only and are subject to change without notice. Consult TE for the latest dimensions, specifications and/or information. Users of TE Connectivity products must make their own assessment as to whether the respective product is suitable for the respective desired application.

ED 01/25

**schaffner**  
MORE POWER TO YOU

is now part of

**TE**  
connectivity

## Looking for pricing, stock, or lifecycle information?

Click below to explore more details on WIN SOURCE:

[View FN2030B-10-06 on WIN SOURCE](#)

[Schaffner EMC Inc. Information](#)

## Optimize Your Supply Chain with WIN SOURCE Solutions

- ✓ Global Sourcing Solution
- ✓ Obsolete Management
- ✓ Cost Control Management
- ✓ Shortage Management
- ✓ Alternative Solution
- ✓ Excess Inventory Management