



**THE DATASHEET OF
GKG60015**



**PLASTIC ENCASED TYPE
GKG SERIES**

FEATURES

- Very low cost.
- Wide selection of capacitance ranges.
- Suitable for printed circuit production methods using "spring leads" or "straight leads".

SPECIFICATIONS

Operating Temperature Range: -25°C to +85°C
 Voltage Rating: 100 VDC
 Dielectric Withstanding Voltage: 220 VDC
 Insulation Resistance: 10⁴ Megohms min
 Torque: 15 to 150 g-cm (0.21 to 2.1 oz-in)

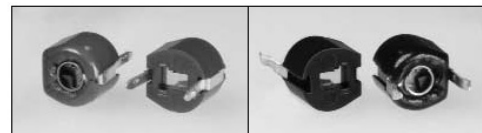

6 mm Economy Models

Capacitance (pF)		TCC (ppm / °C)	Q min (1 MHz)	Color Code	Top Adjust Model No.	Bottom Adjust Model No.
min	max					
1.0	3.0	NPO ± 250	300	Black	GKG3R015	GKG3R016
2.0	5.0	NPO ± 250	300	Blue	GKG5R015	GKG5R016
3.0	10.0	NPO ± 250	300	White	GKG10015	GKG10016
5.0	20.0	N750 ± 250	300	Red	GKG20015	GKG20016
6.5	30.0	N1000 ± 500	200	Green	GKG30015	GKG30016
7.0	40.0	N2200 ± 800	200	Yellow	GKG40015	GKG40016
10.0	50.0	N2200 ± 800	200	Brown	GKG50015	GKG50016
12.0	60.0	N2200 ± 800	200	Brown	GKG60015	GKG60016

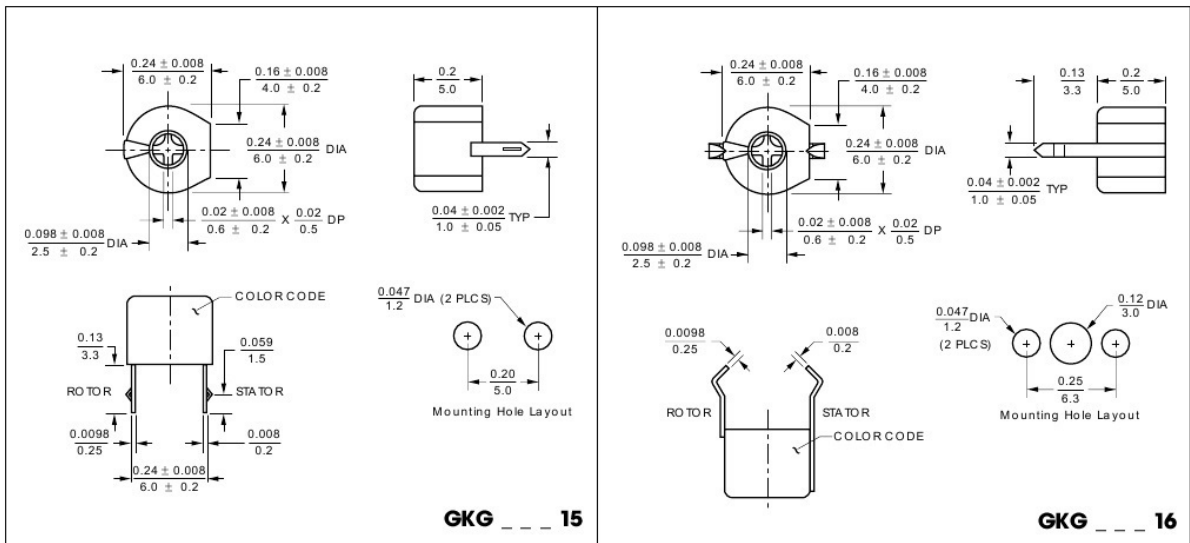

All dimensions are in / mm.
 Unless otherwise specified, the tolerance on dimensions is ± 0.004 / 0.1; except slot tolerance is ± 0.008 / 0.2.

EW Electronics
 9019 Oso Ave.
 Unit-A
 Chatsworth, Ca 91311
 (818)718-2500

Looking for pricing, stock, or lifecycle information?

Click below to explore more details on WIN SOURCE:

 [View GKG60015](#) on WIN SOURCE

 [Manufacturer](#) Information

Optimize Your Supply Chain with WIN SOURCE Solutions

-  Global Sourcing Solution
-  Obsolete Management
-  Cost Control Management
-  Shortage Management
-  Alternative Solution
-  Excess Inventory Management