

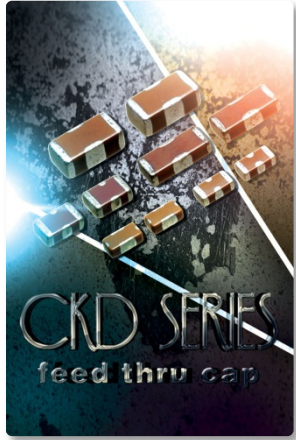

**THE DATASHEET OF  
YFF32SC1E470M**



# CKD SERIES | Feed Thru Capacitor



TDK Feed Thru CKD series capacitors feature 3-terminal design with even lower ESL than Flip Type capacitors. Feed through design consists of 3-terminal construction where the 3rd terminal acts as a ground. Unique internal design allows for low parallel inductance and offer excellent noise reduction capability for high speed digital IC decoupling.

CKD Series are offered in a variety of case size with operating temperature range of -25°C to +85°C and -55°C to +125°C. A wide range of capacitance with rated voltage from 4V to 50V are available.

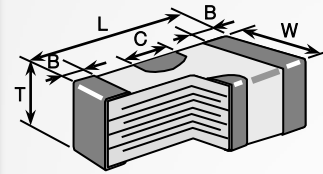

L Body Length  
W Body Width  
T Body Height  
B Terminal Width  
C GND Terminal Width

Case Code	L (mm)	W (mm)	T (mm)	B (mm)	C (mm)
CKD710JB	1.00	0.50	0.30	0.17	0.30
CKD61BJB	1.60	0.80	0.60	0.15	0.80
CKD610JB	1.60	0.80	0.80	0.10	0.40
CKD510JB	2.00	1.25	0.85	0.30	0.40
CKD110JB	3.20	1.25	0.85	0.40	0.95
CKD310JB	3.20	1.60	1.30	0.40	0.95
CKD31C10	3.20	1.60	1.30	0.40	1.20

## Part Number Description

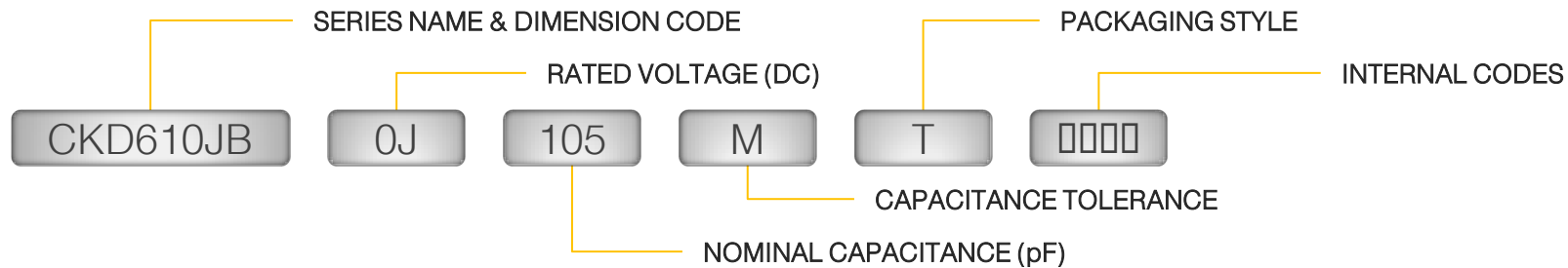

## Features:

- ❖ Ultra low inductance (less than 200 pH)
- ❖ Feed-through structure provides low ESL and high capacitance for noise elimination over a broad frequency band
- ❖ Optimized for use as noise bypass capacitor for signal and power source circuits
- ❖ Aids in EMC compliance

## Applications:

- ❖ IC power supply circuit decoupling
- ❖ High impedance/high current circuits
- ❖ DC to DC converter input/output smoothing

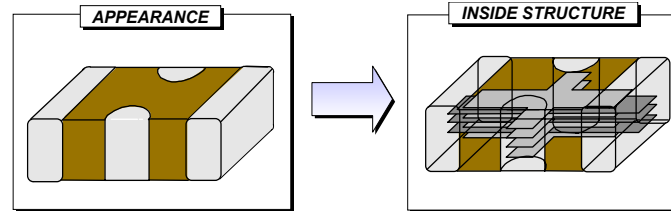

➤ Low ESL Feed Through type CKD series are constructed with 3 terminals and alternating ground and conductive layers.

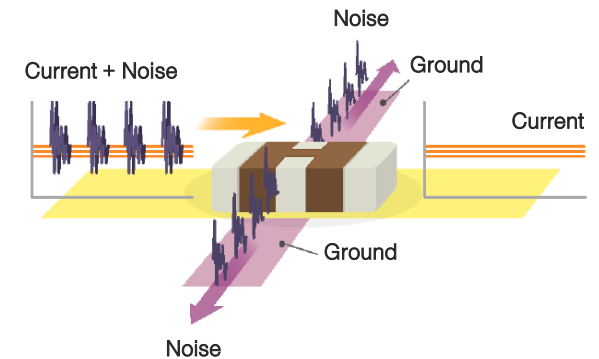
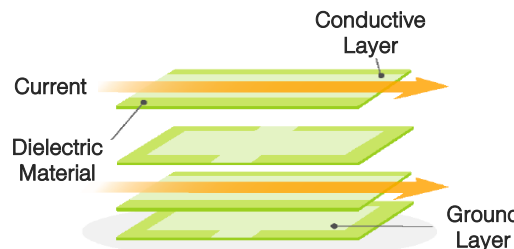

➤ When a pass-through structure is used, the smaller the distance between the capacitor and the ground, the lower the ESL. This helps reduce noise from the circuit.

# CKD SERIES | Feed Thru Capacitor

Capacitance (pF)	Cap Code	CKD710JB 0402/C1005				CKD610JB 0603/C1608		CKD61BJB 0603/C1608		CKD510JB 0805/C2012					CKD110JB 1205/C3212		CKD310JB 1206/C3216		CKD31C10 1206/C3216	
		1C (16V)	1A (10V)	0J (6.3V)	0G (4V)	1A (10V)	0J (6.3V)	1A (10V)	0J (6.3V)	1H (50V)	1E (25V)	1C (16V)	1A (10V)	0J (6.3V)	1H (50V)	1E (25V)	1C (16V)	0J (6.3V)	1H (50V)	1E (25V)
22	220									█					█					
47	470									█					█					
100	101									█					█					
220	221									█					█					
470	471									█					█					
1,000	102									█					█					
2,200	222									█					█					
4,700	472									█					█					
10,000	103									█					█					
15,000	153									█					█					
22,000	223									█					█					
47,000	473									█					█					
100,000	104	█								█					█					
220,000	224	█	█							█					█					
470,000	474	█	█	█						█					█					
1,000,000	105	█	█	█	█					█					█					
2,200,000	225	█	█	█	█					█					█					
4,700,000	475	█	█	█	█					█					█					
10,000,000	106	█	█	█	█					█					█					
22,000,000	226	█	█	█	█					█					█					

█ -25°C to +125°C   █ -25°C to +85°C

## Attenuation Characteristics

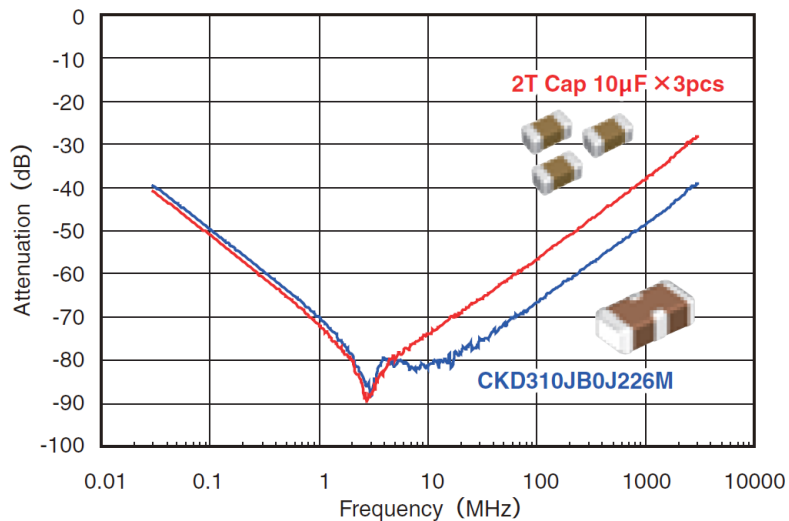

➤ It is possible to reduce the number of components with CKD Series capacitor because one CKD part has similar or better attenuation characteristics as three standard 2-terminal capacitors.

## Target Application

➤ In high-frequency application, the equivalent series resistance (ESR) and equivalent series Inductance (ESL) of a capacitor's internal electrodes and terminal electrodes become apparent. ESL acts as a hindrance, reflecting the signal current. Feed Thru Capacitor allow for better filtering and decoupling due to low ESL and ESR.

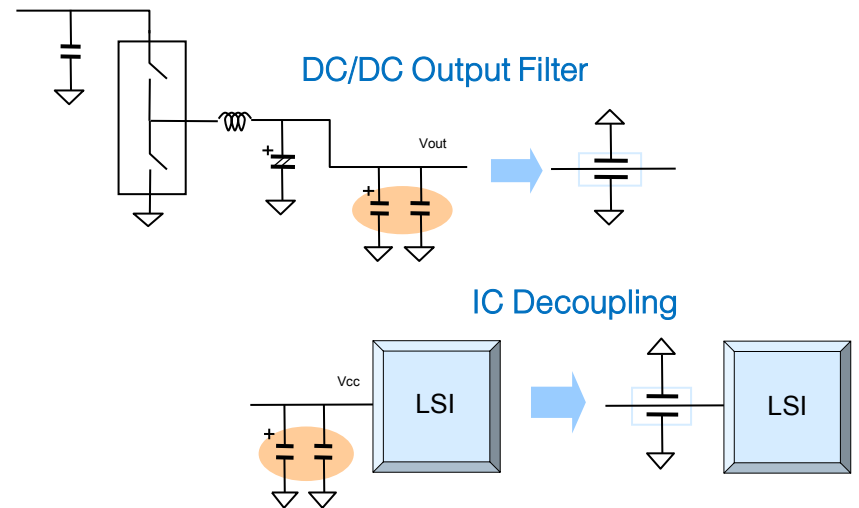

## Looking for pricing, stock, or lifecycle information?

Click below to explore more details on WIN SOURCE:

 [View YFF32SC1E470M on WIN SOURCE](#)

 [TDK Corporation Information](#)

## Optimize Your Supply Chain with WIN SOURCE Solutions

-  Global Sourcing Solution
-  Obsolete Management
-  Cost Control Management
-  Shortage Management
-  Alternative Solution
-  Excess Inventory Management