



**THE DATASHEET OF  
IP4369CX4YL**



# IP4369CX4

## ESD protection for high-speed interfaces

Rev. 1 — 1 October 2012

Product data sheet

## 1. Product profile

---

### 1.1 General description

The device is designed to protect high-speed interfaces such as High-Definition Multimedia Interface (HDMI), DisplayPort, USB, external Serial Advanced Technology Attachment (eSATA) and Low Voltage Differential Signaling (LVDS) interfaces against ElectroStatic Discharge (ESD).

The device includes high-level ESD protection diodes structure for high-speed signal lines in a 4-channel 0.4 mm pitch single Wafer-Level Chip-Scale Package (WLCSP). These features make the device ideal for use in applications requiring component miniaturization such as mobile phone handsets and other portable electronic devices.

All signal lines are protected by a special diode configuration offering ultra low line capacitance of 0.8 pF (typical). These diodes provide protection to downstream components from ESD voltages up to  $\pm 8$  kV contact according to IEC 61000-4-2, level 4.

### 1.2 Features and benefits

- Pb-free, Restriction of Hazardous Substances (RoHS) compliant and free of halogen and antimony (Dark Green compliant)
- System ESD protection for USB 2.0, USB On-The-Go (USB OTG), Ethernet and Digital Visual Interface (DVI)
- All signal lines with integrated rail-to-rail clamping diodes structure for downstream ESD protection of  $\pm 8$  kV according to IEC 61000-4-2, level 4
- $2 \times 2$  solder ball WLCSP with 0.4 mm pitch and height  $< 500 \mu\text{m}$
- Signal lines with  $\leq 0.05$  pF matching capacitance between signal pairs
- Line capacitance of only 0.8 pF for each channel

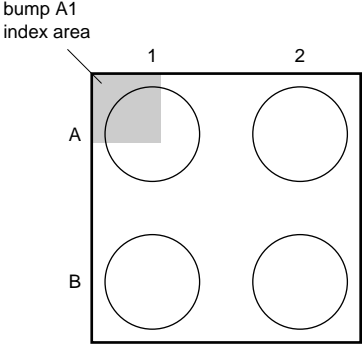
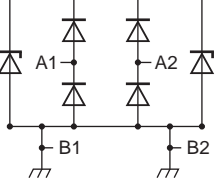
### 1.3 Applications

The device is designed for high-speed receiver and transmitter port protection:

- Portable devices
- Mobile handsets
- Wireless data systems
- Digital cameras

## 2. Pinning information

Table 1. Pinning

Pin	Description	Simplified outline	Graphic symbol
A1 and A2	ESD protection	 <p>008aaa236</p> <p>transparent top view, solder balls facing down</p>	 <p>018aaa224</p>
B1 and B2	ground		

## 3. Ordering information

Table 2. Ordering information

Type number	Package		
	Name	Description	Version
IP4369CX4	WLCSP4	wafer level chip-size package; 4 bumps (2 × 2)	IP4369CX4

## 4. Limiting values

Table 3. Limiting values

In accordance with the Absolute Maximum Rating System (IEC 60134).

Symbol	Parameter	Conditions	Min	Max	Unit
$V_I$	input voltage		-0.5	+5.5	V
$V_{ESD}$	electrostatic discharge voltage	IEC 61000-4-2, level 4; <a href="#">[1]</a> contact discharge	-	±8	kV
$T_{stg}$	storage temperature		-55	+150	°C
$T_{reflow(peak)}$	peak reflow temperature	$t_p \leq 10$ s	-	+260	°C
$T_{amb}$	ambient temperature		-30	+85	°C

[1] Pins A1 and A2 to ground (B1 and B2).

5. Characteristics

Table 4. Characteristics

$T_{amb} = 25\text{ }^{\circ}\text{C}$  unless otherwise specified.

Symbol	Parameter	Conditions	Min	Typ	Max	Unit
$C_{line}$	line capacitance	per pin; pins A1 and A2 to GDN; $V_{bias} = 0\text{ V}$ ; $f = 1\text{ MHz}$	[1]	-	0.8	1 pF
$C_{(I/O-I/O)}$	input/output to input/output capacitance	GND not connected; $V_{bias} = 0\text{ V}$ ; $f = 1\text{ MHz}$	[1]	-	0.4	pF
$I_{RM}$	reverse leakage current	$V_{bias} = 3\text{ V}$	-	-	100	nA
$V_{BR}$	breakdown voltage	$I_{test} = 1\text{ mA}$	6	-	10	V
$V_F$	forward voltage		-	-0.7	-	V
$R_{dyn}$	dynamic resistance	TLP	[2]			
		positive transient	-	0.24	-	$\Omega$
		negative transient	-	0.21	-	$\Omega$
		surge	[3]			
		positive transient	-	0.21	-	$\Omega$
		negative transient	-	0.16	-	$\Omega$
$V_{CL}$	clamping voltage	$I_{CL} = 4\text{ A}$	[3]	-	4	V
		$I_{CL} = -5\text{ A}$	[3]	-	-3	V

- [1] This parameter is guaranteed by design.
- [2] 100 ns Transmission Line Pulse (TLP); 50  $\Omega$ ; pulser at 80 ns.
- [3] According to IEC 61000-4-5 (8/20  $\mu\text{s}$ ).

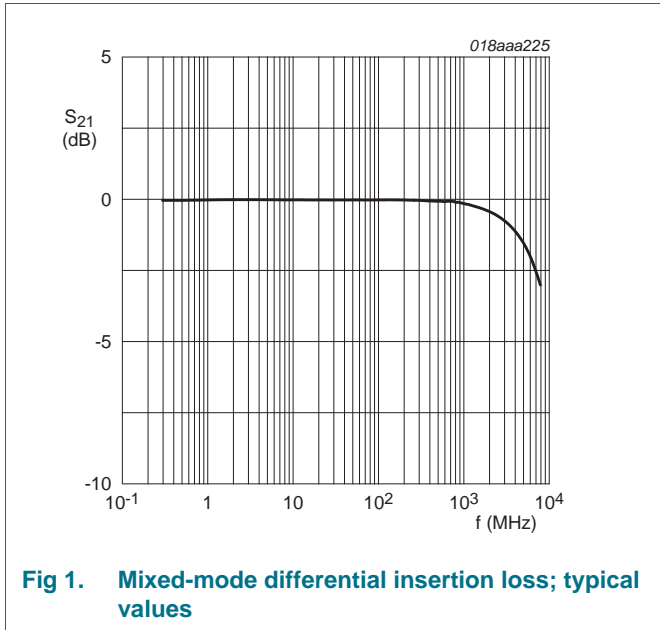


Fig 1. Mixed-mode differential insertion loss; typical values

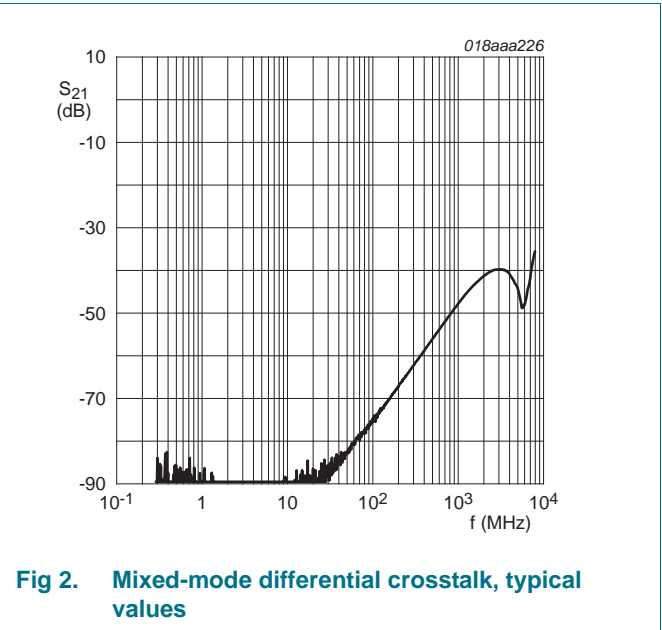
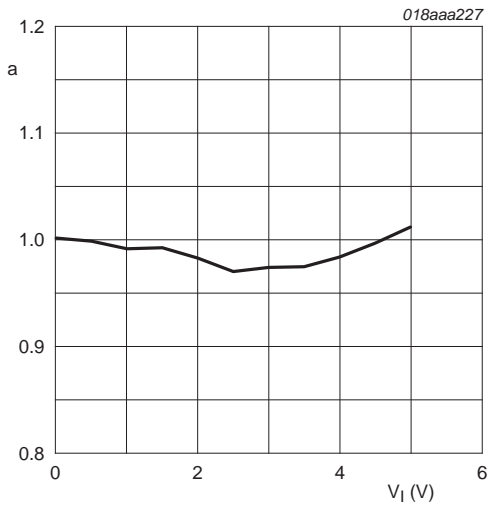
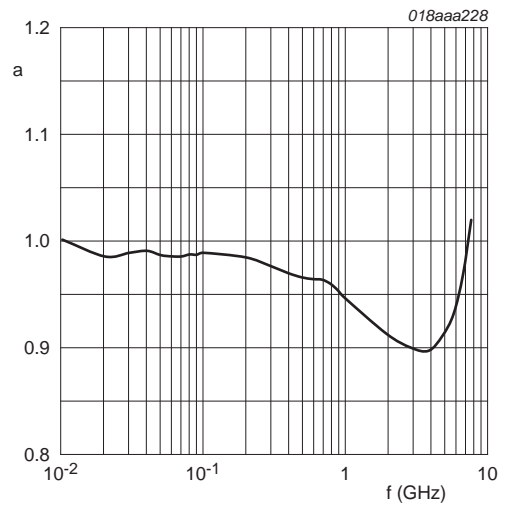


Fig 2. Mixed-mode differential crosstalk, typical values



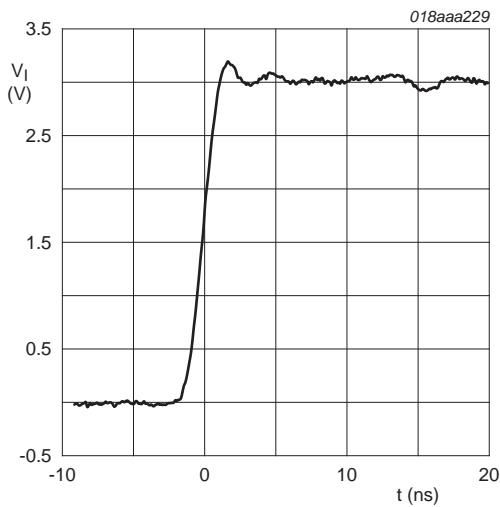
$$a = \frac{C_{line}}{C_{line}(V_{bias} = 0V)}$$

**Fig 3. Relative capacitance as a function of input voltage; typical values**

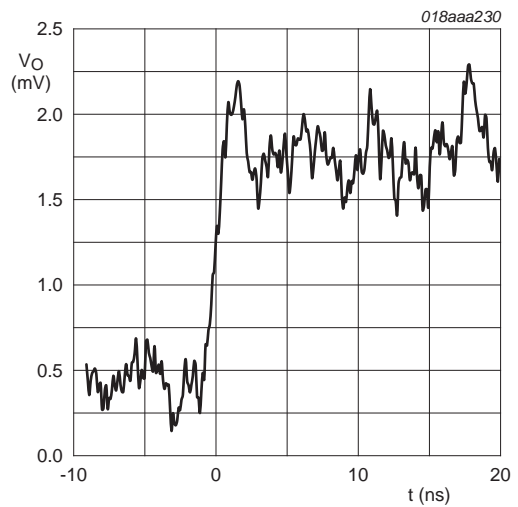


$$a = \frac{C_{line}}{C_{line}(f = 10MHz)}$$

**Fig 4. Relative capacitance as a function of frequency; typical values**

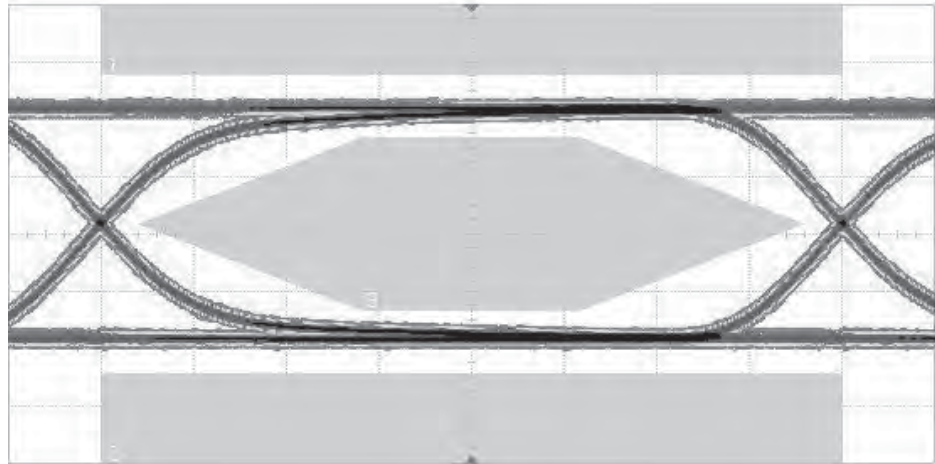


**Fig 5. Input voltage for crosstalk measurements; channel 1; typical values**



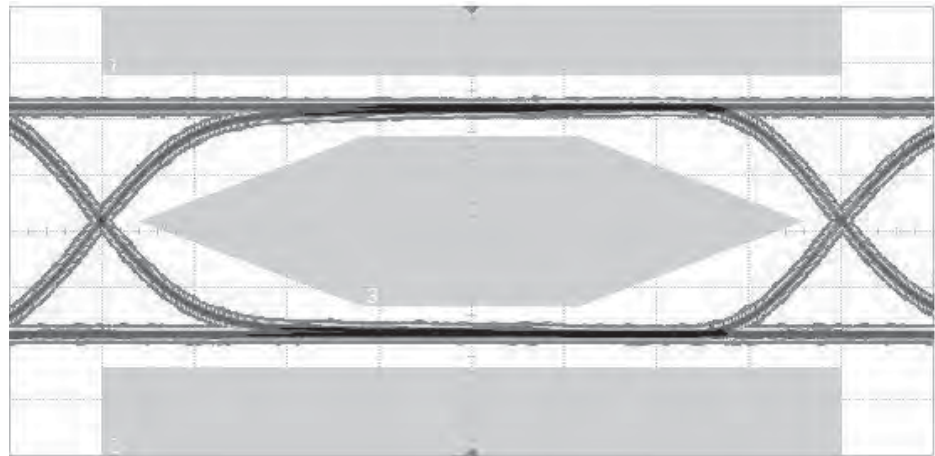
**Fig 6. Output voltage for crosstalk measurements; channel 2; typical values**

Figure 5 and 6 show time-domain crosstalk from channel 1 to channel 2. Generator impedance on channel 1 is 50 Ω, probe impedance on channel 2 is 1 MΩ.



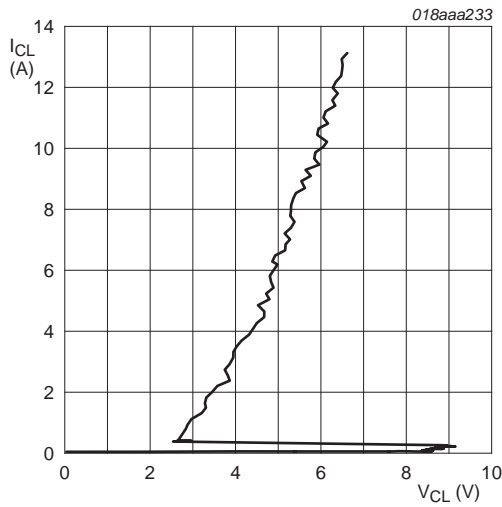
Data rate: 480 Mbit/s (USB 2.0 High-speed)  
Vertical scale = 200 mV/div  
Horizontal scale = 260 ps/div

**Fig 7. USB 2.0 eye diagram with IP4369CX4**



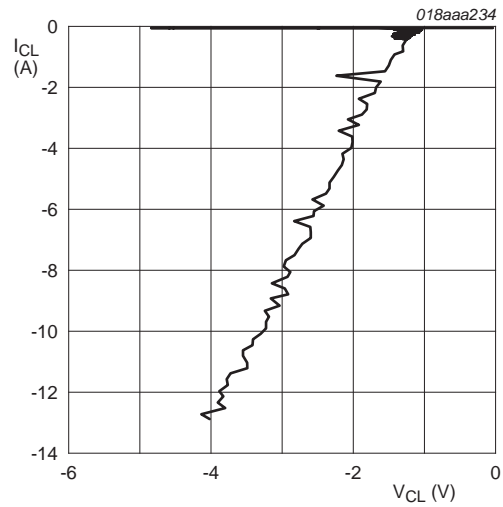
Data rate: 480 Mbit/s (USB 2.0 High-speed)  
Vertical scale = 200 mV/div  
Horizontal scale = 260 ps/div

**Fig 8. USB 2.0 eye diagram without IP4369CX4**



$t_p = 100$  ns; Transmission Line Pulse (TLP)

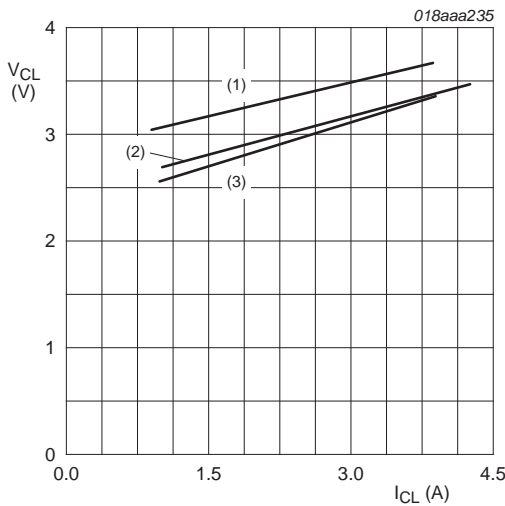
**Fig 9. Dynamic resistance with positive clamping**



$t_p = 100$  ns; Transmission Line Pulse (TLP)

**Fig 10. Dynamic resistance with negative clamping**

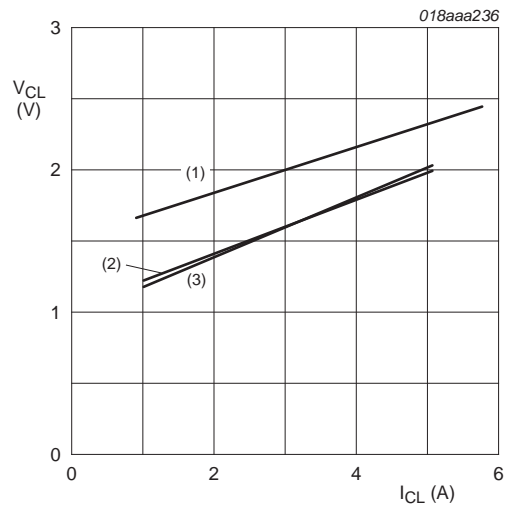
The device uses an advanced clamping structure showing a negative dynamic resistance. This snap-back behavior strongly reduces the clamping voltage to the system behind the ESD protection during an ESD event. Do not connect unlimited DC current sources to the data lines to avoid keeping the ESD protection device in snap-back state after exceeding breakdown voltage (due to an ESD pulse for instance).



IEC 61000-4-5

- (1)  $T_{amb} = 25$  °C;  $y = 0.21x + 2.86$
- (2)  $T_{amb} = 75$  °C
- (3)  $T_{amb} = 125$  °C

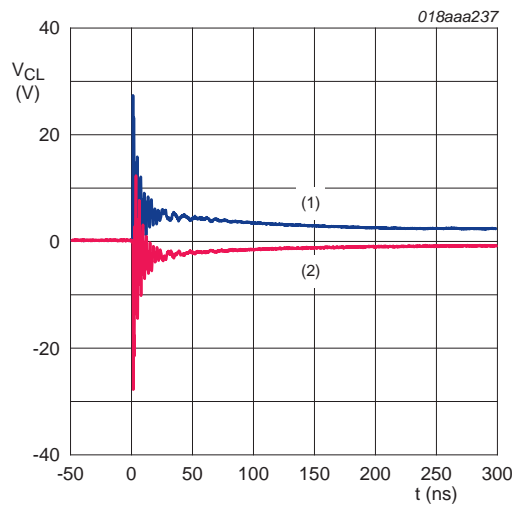
**Fig 11. Surge pulse response test; positive transient, typical values**



IEC 61000-4-5

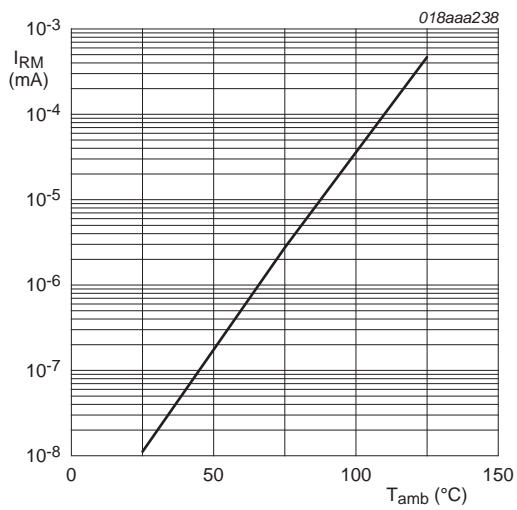
- (1)  $T_{amb} = 25$  °C;  $y = 0.16x + 1.52$
- (2)  $T_{amb} = 75$  °C
- (3)  $T_{amb} = 125$  °C

**Fig 12. Surge pulse response test; negative transient, typical values**



- (1) +8 kV
- (2) -8 kV

Fig 13. ESD pulse transient response; IEC 61000-4-2; contact discharge; typical values



$V_{bias} = 3 V$

Fig 14. Reverse leakage current as a function of ambient temperature; typical values

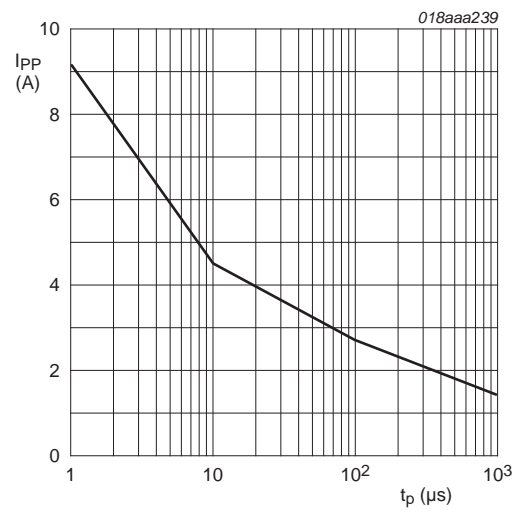


Fig 15. Peak pulse current as a function of pulse duration; rectangular pulses; typical values

## 6. Package outline

WLCSP4: wafer level chip-size package; 4 bumps (2 x 2)

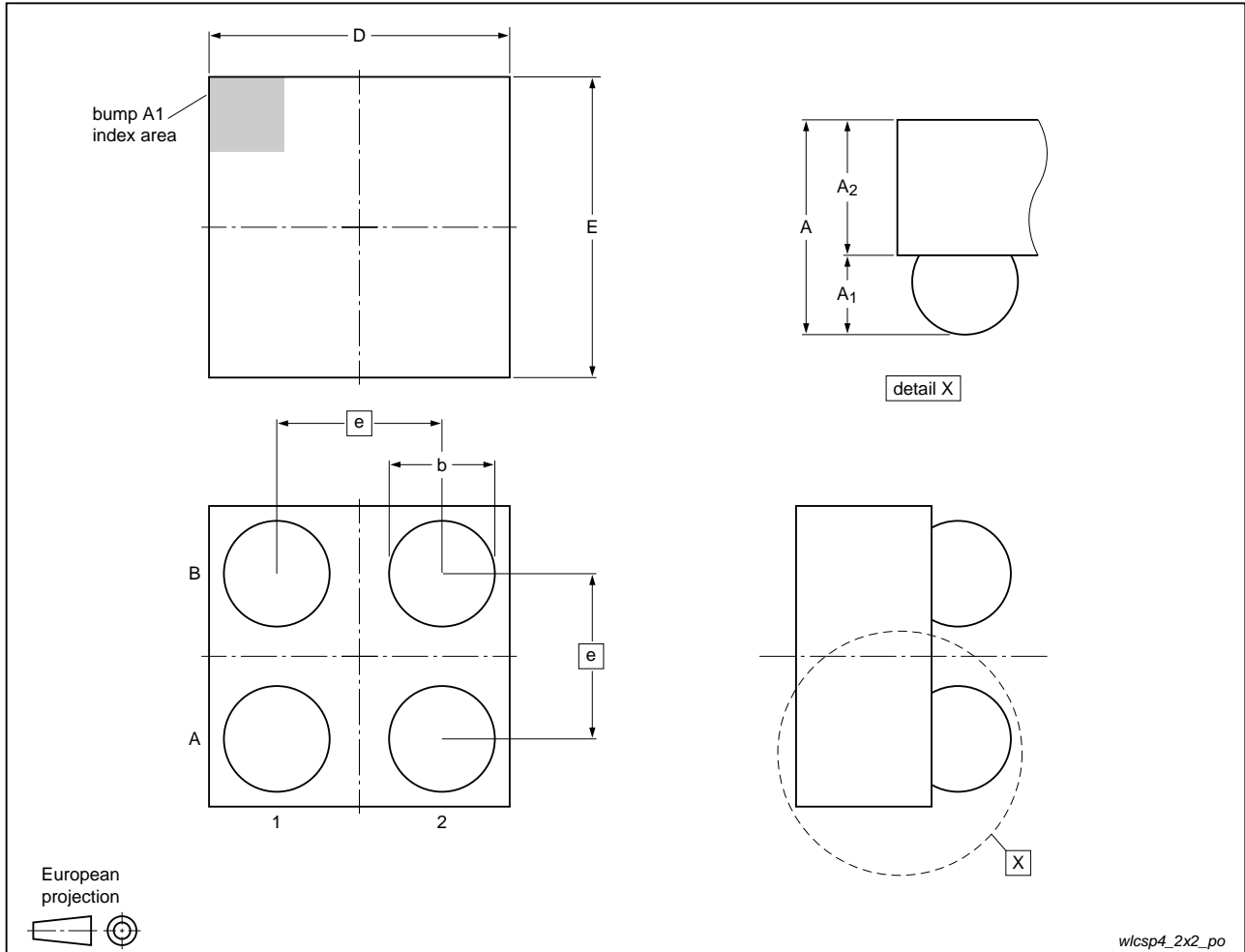


Fig 16. Package outline IP4369CX4 (WLCSP4)

Table 5. Package outline dimensions of IP4369CX4 (WLCSP4)

Symbol	Min	Typ	Max	Unit
A	0.44	0.47	0.50	mm
A <sub>1</sub>	0.18	0.20	0.22	mm
A <sub>2</sub>	0.26	0.27	0.28	mm
b	0.21	0.26	0.31	mm
D	0.71	0.76	0.81	mm
E	0.71	0.76	0.81	mm
e	0.35	0.40	0.45	mm

## 7. Design and assembly recommendations

### 7.1 PCB design guidelines

For optimum performance, use a Non-Solder Mask Defined (NSMD), also known as a copper-defined design, incorporating laser-drilled micro-vias connecting the ground pads to a buried ground-plane layer. This results in the lowest possible ground inductance and provides the best high frequency and ESD performance. Refer to [Table 6](#) for the recommended Printed-Circuit Board (PCB) design parameters.

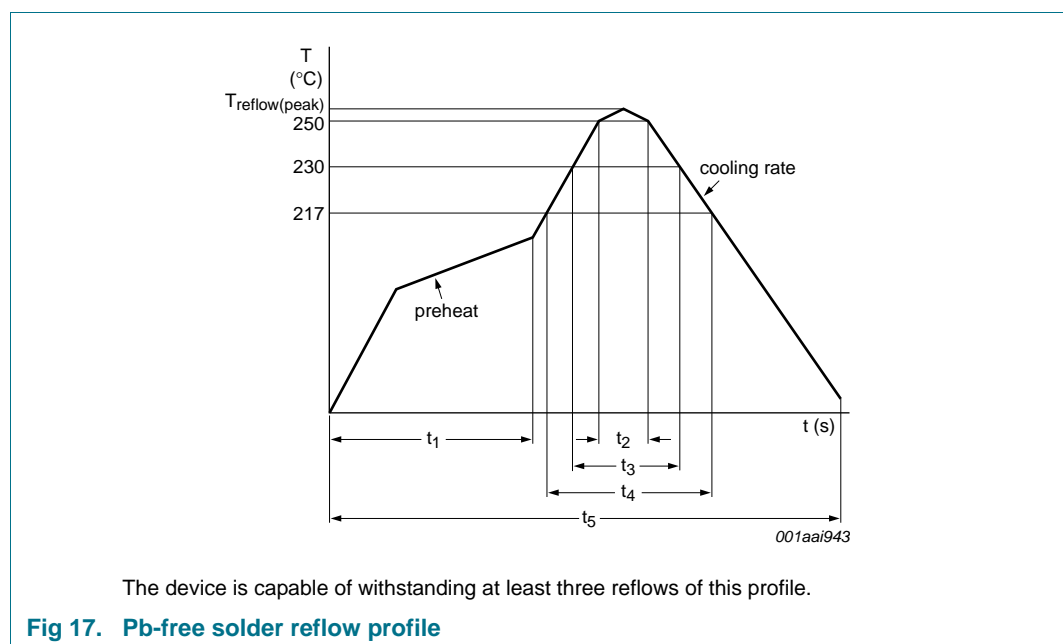
**Table 6. Recommended PCB design parameters**

Parameter	Value or specification
PCB pad diameter	250 $\mu\text{m}$
Micro-via diameter	100 $\mu\text{m}$ (0.004 inch)
Solder mask aperture diameter	325 $\mu\text{m}$
Copper thickness	20 $\mu\text{m}$ to 40 $\mu\text{m}$
Copper finish	AuNi
PCB material	FR4

### 7.2 PCB assembly guidelines for Pb-free soldering

**Table 7. Assembly recommendations**

Parameter	Value or specification
Solder screen aperture diameter	290 $\mu\text{m}$
Solder screen thickness	100 $\mu\text{m}$ (0.004 inch)
Solder paste: Pb-free	SnAg (3 % to 4 %) Cu (0.5 % to 0.9 %)
Solder to flux ratio	50 : 50
Solder reflow profile	see <a href="#">Figure 17</a>



**Table 8. Characteristics**

Symbol	Parameter	Conditions	Min	Typ	Max	Unit
$T_{\text{reflow(peak)}}$	peak reflow temperature		230	-	260	°C
$t_1$	time 1	soak time	60	-	180	s
$t_2$	time 2	time during $T \geq 250$ °C	-	-	30	s
$t_3$	time 3	time during $T \geq 230$ °C	10	-	50	s
$t_4$	time 4	time during $T > 217$ °C	30	-	150	s
$t_5$	time 5		-	-	540	s
$dT/dt$	rate of change of temperature	cooling rate	-	-	-6	°C/s
		pre-heat	2.5	-	4.0	°C/s

## 8. Revision history

Table 9. Revision history

Document ID	Release date	Data sheet status	Change notice	Supersedes
IP4369CX4 v.1	20121001	Product data sheet	-	-

## 9. Legal information

### 9.1 Data sheet status

Document status <sup>[1][2]</sup>	Product status <sup>[3]</sup>	Definition
Objective [short] data sheet	Development	This document contains data from the objective specification for product development.
Preliminary [short] data sheet	Qualification	This document contains data from the preliminary specification.
Product [short] data sheet	Production	This document contains the product specification.

[1] Please consult the most recently issued document before initiating or completing a design.

[2] The term 'short data sheet' is explained in section "Definitions".

[3] The product status of device(s) described in this document may have changed since this document was published and may differ in case of multiple devices. The latest product status information is available on the Internet at URL <http://www.nexperia.com>.

### 9.2 Definitions

**Draft** — The document is a draft version only. The content is still under internal review and subject to formal approval, which may result in modifications or additions. Nexperia does not give any representations or warranties as to the accuracy or completeness of information included herein and shall have no liability for the consequences of use of such information.

**Short data sheet** — A short data sheet is an extract from a full data sheet with the same product type number(s) and title. A short data sheet is intended for quick reference only and should not be relied upon to contain detailed and full information. For detailed and full information see the relevant full data sheet, which is available on request via the local Nexperia sales office. In case of any inconsistency or conflict with the short data sheet, the full data sheet shall prevail.

**Product specification** — The information and data provided in a Product data sheet shall define the specification of the product as agreed between Nexperia and its customer, unless Nexperia and customer have explicitly agreed otherwise in writing. In no event however, shall an agreement be valid in which the Nexperia product is deemed to offer functions and qualities beyond those described in the Product data sheet.

### 9.3 Disclaimers

**Limited warranty and liability** — Information in this document is believed to be accurate and reliable. However, Nexperia does not give any representations or warranties, expressed or implied, as to the accuracy or completeness of such information and shall have no liability for the consequences of use of such information. Nexperia takes no responsibility for the content in this document if provided by an information source outside of Nexperia.

In no event shall Nexperia be liable for any indirect, incidental, punitive, special or consequential damages (including - without limitation - lost profits, lost savings, business interruption, costs related to the removal or replacement of any products or rework charges) whether or not such damages are based on tort (including negligence), warranty, breach of contract or any other legal theory.

Notwithstanding any damages that customer might incur for any reason whatsoever, Nexperia's aggregate and cumulative liability towards customer for the products described herein shall be limited in accordance with the *Terms and conditions of commercial sale* of Nexperia.

**Right to make changes** — Nexperia reserves the right to make changes to information published in this document, including without limitation specifications and product descriptions, at any time and without notice. This document supersedes and replaces all information supplied prior to the publication hereof.

**Suitability for use** — Nexperia products are not designed, authorized or warranted to be suitable for use in life support, life-critical or safety-critical systems or equipment, nor in applications where failure or malfunction of a Nexperia product can reasonably be expected to result in personal injury, death or severe property or environmental damage. Nexperia and its suppliers accept no liability for inclusion and/or use of Nexperia products in such equipment or applications and therefore such inclusion and/or use is at the customer's own risk.

**Applications** — Applications that are described herein for any of these products are for illustrative purposes only. Nexperia makes no representation or warranty that such applications will be suitable for the specified use without further testing or modification.

Customers are responsible for the design and operation of their applications and products using Nexperia products, and Nexperia accepts no liability for any assistance with applications or customer product design. It is customer's sole responsibility to determine whether the Nexperia product is suitable and fit for the customer's applications and products planned, as well as for the planned application and use of customer's third party customer(s). Customers should provide appropriate design and operating safeguards to minimize the risks associated with their applications and products.

Nexperia does not accept any liability related to any default, damage, costs or problem which is based on any weakness or default in the customer's applications or products, or the application or use by customer's third party customer(s). Customer is responsible for doing all necessary testing for the customer's applications and products using Nexperia products in order to avoid a default of the applications and the products or of the application or use by customer's third party customer(s). Nexperia does not accept any liability in this respect.

**Limiting values** — Stress above one or more limiting values (as defined in the Absolute Maximum Ratings System of IEC 60134) will cause permanent damage to the device. Limiting values are stress ratings only and (proper) operation of the device at these or any other conditions above those given in the Recommended operating conditions section (if present) or the Characteristics sections of this document is not warranted. Constant or repeated exposure to limiting values will permanently and irreversibly affect the quality and reliability of the device.

**Terms and conditions of commercial sale** — Nexperia products are sold subject to the general terms and conditions of commercial sale, as published at <http://www.nexperia.com/profile/terms>, unless otherwise agreed in a valid written individual agreement. In case an individual agreement is concluded only the terms and conditions of the respective agreement shall apply. Nexperia hereby expressly objects to applying the customer's general terms and conditions with regard to the purchase of Nexperia products by customer.

**No offer to sell or license** — Nothing in this document may be interpreted or construed as an offer to sell products that is open for acceptance or the grant, conveyance or implication of any license under any copyrights, patents or other industrial or intellectual property rights.

**Export control** — This document as well as the item(s) described herein may be subject to export control regulations. Export might require a prior authorization from competent authorities.

**Quick reference data** — The Quick reference data is an extract of the product data given in the Limiting values and Characteristics sections of this document, and as such is not complete, exhaustive or legally binding.

**Non-automotive qualified products** — Unless this data sheet expressly states that this specific Nexperia product is automotive qualified, the product is not suitable for automotive use. It is neither qualified nor tested in accordance with automotive testing or application requirements. Nexperia accepts no liability for inclusion and/or use of non-automotive qualified products in automotive equipment or applications.

In the event that customer uses the product for design-in and use in automotive applications to automotive specifications and standards, customer (a) shall use the product without Nexperia's warranty of the product for such automotive applications, use and specifications, and (b) whenever customer uses the product for automotive applications beyond Nexperia's specifications such use shall be solely at customer's own risk, and (c) customer fully indemnifies Nexperia for any liability, damages or failed product claims resulting from customer design and use of the product for automotive applications beyond Nexperia's standard warranty and Nexperia's product specifications.

## 9.4 Trademarks

Notice: All referenced brands, product names, service names and trademarks are the property of their respective owners.

## 10. Contact information

For more information, please visit: <http://www.nexperia.com>

For sales office addresses, please send an email to: [salesaddresses@nexperia.com](mailto:salesaddresses@nexperia.com)

## 11. Contents

---

<b>1</b>	<b>Product profile</b> . . . . .	<b>1</b>
1.1	General description . . . . .	1
1.2	Features and benefits . . . . .	1
1.3	Applications . . . . .	1
<b>2</b>	<b>Pinning information</b> . . . . .	<b>2</b>
<b>3</b>	<b>Ordering information</b> . . . . .	<b>2</b>
<b>4</b>	<b>Limiting values</b> . . . . .	<b>2</b>
<b>5</b>	<b>Characteristics</b> . . . . .	<b>3</b>
<b>6</b>	<b>Package outline</b> . . . . .	<b>8</b>
<b>7</b>	<b>Design and assembly recommendations</b> . . . . .	<b>9</b>
7.1	PCB design guidelines . . . . .	9
7.2	PCB assembly guidelines for Pb-free soldering . . . . .	9
<b>8</b>	<b>Revision history</b> . . . . .	<b>11</b>
<b>9</b>	<b>Legal information</b> . . . . .	<b>12</b>
9.1	Data sheet status . . . . .	12
9.2	Definitions . . . . .	12
9.3	Disclaimers . . . . .	12
9.4	Trademarks . . . . .	13
<b>10</b>	<b>Contact information</b> . . . . .	<b>13</b>
<b>11</b>	<b>Contents</b> . . . . .	<b>14</b>

## Looking for pricing, stock, or lifecycle information?

Click below to explore more details on WIN SOURCE:

 [View IP4369CX4YL on WIN SOURCE](#)

 [Nexperia USA Inc. Information](#)

## Optimize Your Supply Chain with WIN SOURCE Solutions

-  Global Sourcing Solution
-  Obsolete Management
-  Cost Control Management
-  Shortage Management
-  Alternative Solution
-  Excess Inventory Management