



**THE DATASHEET OF  
C016 20H003 210 12**



# eco|mate<sup>m</sup>

## Circular Connectors



# Note from the CEO



Ladies and Gentlemen,

For over 75 years Amphenol has enjoyed success as the interconnection technology provider of choice to industry-leading companies around the world. One of our key strategic areas of focus has been and is the Industrial market. Our organization works with leading manufacturers across a wider range of applications - including Energy Generation & Distribution, Transportation, Heavy Equipment, Factory Automation, Wireless Outdoor, Chip Card Readers - enabling smarter, faster and better technologies to connect products to customer solutions.

The Industrial market footprint of Amphenol covers over facilities in more than 12 different European countries and more than 30 countries worldwide. Our successful expansion into new regions as well as new industrial applications is a direct reflection of our agile, entrepreneurial management team and our unwavering commitment to execute Amphenol's strategies for the benefit of our customers, shareholders and employees.

Thank you for partnering with Amphenol. Our entire organization is at your service.

A handwritten signature in black ink, appearing to read 'R. Adam Norwitt'. The signature is fluid and cursive, with a long horizontal stroke at the end.

R. Adam Norwitt  
President and CEO, Amphenol Corporation

# Make use of the best Use our global resources

“Think global, act local!” Independently from where you are in Europe, we offer you our global expertise and great variety of products and technologies. And in comfort with your personal contact. Our numerous European offices are your access to our global resources.

## ● OUR OFFICES IN EUROPE AND WORLDWIDE

FRANCE	CHINA	AUSTRALIA	SOUTH AFRICA
GERMANY	KOREA	MEXICO	INDIA
UNITED KINGDOM	TAIWAN	USA	ITALY

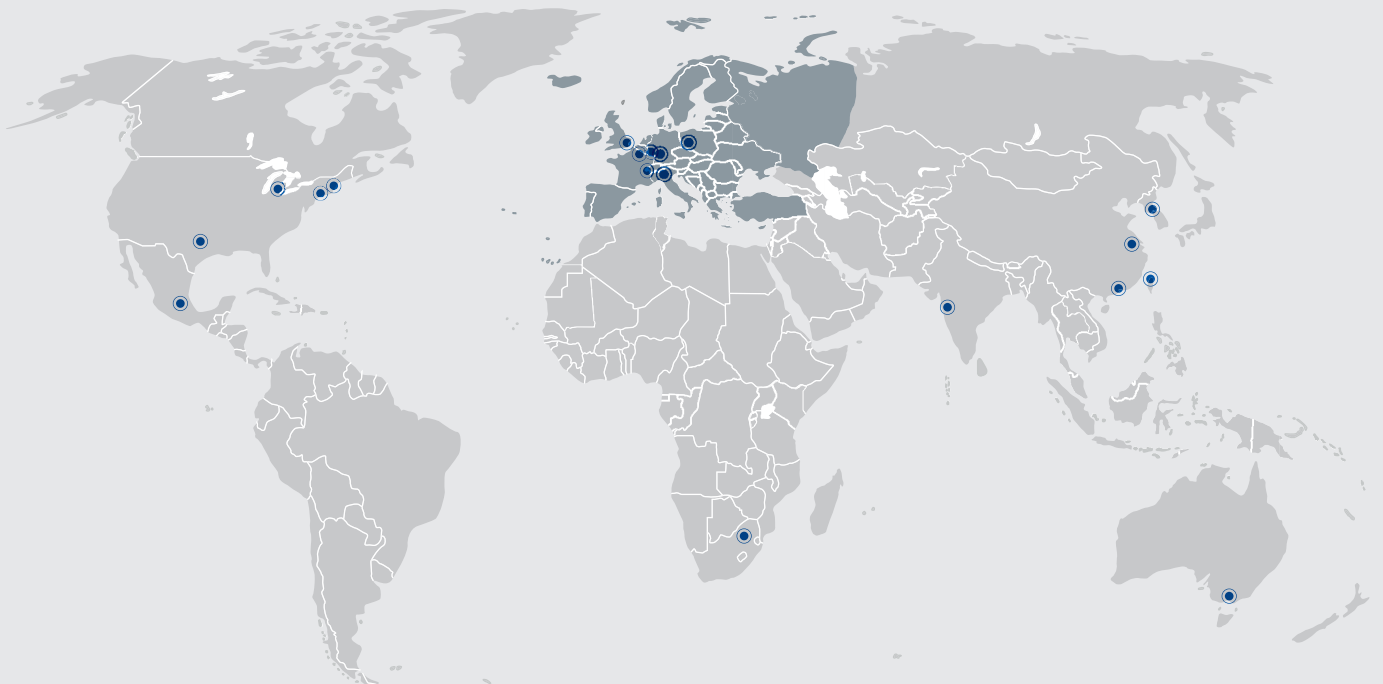



SECURITY, RELIABILITY AND COMFORTABLE SERVICE FROM ONE SOURCE.

# More time for important things: benefit from our service and diversity

Enjoy security, reliability and comfortable service from one source. INDUSTRIAL@AMPHENOL offers one of the most individual and most diversified service programmes in the market – exclusively for industrial customers. Access all possibilities of the Amphenol group through your personal expert adviser.



## WIDE PRODUCT RANGE

Take advantage of a choice of Amphenol products. Our broad product portfolio offers individual solutions from more than 85 member companies in the global Amphenol group.



## EXCLUSIVENESS AND FLEXIBILITY

One face to the customer: every inquiry is handled on an individual service level by your personal key account service partner. This ensures maximum transparency and best-in-class flexibility in the whole process.



## QUALITY

Interconnect systems need reliability, speed and flawless data transmission. We continuously test and guarantee the required standard in our products – and also in our personal services.



## INDIVIDUAL SOLUTIONS

Your project requires an individual solution that is not available off-the-shelf? As your think tank and discussion partner we provide engineering support and solution-oriented development for your tailor-made Amphenol product.



## SPEED AND AVAILABILITY

Smart and intelligent processes are the secret behind our service programme. Flexible planning and distribution, perfect logistics and highest availability are our key factors for best customer service.







## GLOBAL KEY ACCOUNT SERVICE

Our key account service is your individual entrance to global know-how, products and services. More than 85 Amphenol companies around the world offer an extensive range of technologies and products. We offer access to our worldwide resources through one individual contact person.



Content	Seite
Brief Information	8
General Information	9
eco mate Standard	10
eco mate High Voltage	14
eco mate Special Types	17
Crimp contacts	20
Accessories	21
Tools	22
Protective covers	23
Mounting Instructions	24
Technical Information	25
Remarks / Safety Classification	28
Summary of Part Numbers	29



Approvals, Testhouse	Characteristics	Approval Numbers
VDE 	3+PE, 400 V, 16 A 6+PE, 250 V, 10 A (solder version) 6+PE, 250 V, 13 A (crimp version)	56 79 ÜG
SEV 	3+PE, 400 V, 16 A 6+PE, 250 V, 10 A (solder version) 6+PE, 250 V, 13 A (crimp version)	
UL <sup>1)</sup> 	3+PE, 400 V, 16A 6+PE, 250 V, 13A 3+PE, 600 V, 13 A at AWG 16 (High Voltage) 3+PE, 600 V, 5 A at AWG 26 (High Voltage) 6+PE, 600 V, 13 A at AWG 16 (High Voltage) 6+PE, 600 V, 5 A at AWG 26 (High Voltage)	E 63093
CSA 	3+PE, 250 V, 12 A 6+PE, 250 V, 8 A 3+PE, 600 V, 10.5 A at AWG 16 (High Voltage) 6+PE, 600 V, 10.5 A at AWG 16 (High Voltage)	48932

In general approvals refer to versions of the connector series. Test report upon request.

### General Remarks

In design and conception, the eco|mate<sup>m</sup> program meets the high requirements for applications in industrial technology. Easy operation, reduced dimensions and a more robust design are only a few of the features of the series.

The connector's main area of application is in the fields of plant construction and machine building. The connector is used for measuring and controlling applications as well as for power supply technology. The series is comprised of a large selection of housings and shapes and offers models with screw, solder and crimp termination.

### Features

- Circular Connectors with 3+PE and 6+PE contacts
- Housing components made from premium molding material
- Cable housing straight or angled
- Protection class IP 65/67 in mated condition in accordance with DIN EN 60526
- Clamping ring or internal strain relief

### Advantages

- Quick and easy assembly
- Screwed cable gland with clamping ring
- Strain relief and mounted gasket all in one component
- Cable housing, straight or angled, for the cable diameter 6 - 12.5 mm
- Robust thread for the screwed cable gland
- Ergonomically designed product range for safe handling
- Pre-loaded ground contact
- Fastening for the protective covers on the housing of the receptacles
- The eco|mate<sup>m</sup> program is compatible with the C16-1 series



### Additional standards

The 6+PE model corresponds to DIN 9684-1 interface to the signal transmission on inside cabin applications for agricultural machines and tractors

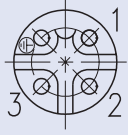

eco|mate<sup>m</sup>

Standard

General Characteristics		Standard			Characteristics		
Number of contacts		3 + PE		6 + PE			
Termination technique		screw type		soldertype	crimp type		
Wire gauge / AWG		0.75 - 2.5 mm <sup>2</sup> AWG 18-14		max. 0.75 mm <sup>2</sup> AWG 18	0.14 - 1.5 mm <sup>2</sup> AWG 26 - 16		
Flammability	UL 94	VO					
Locking system		round thread					
View on termination side of male contact insert							
Electrical Characteristics		Standard			Characteristics		
Rated voltage	IEC 60664-1 <sup>1)</sup>	400 V		250 V			
Pollution degree	IEC 60664-1 <sup>1)</sup>	3					
Installation category	IEC 60664-1 <sup>1)</sup>	III					
Insulation group	IEC 60664-1 <sup>1)</sup>	II					
Rated impulse withstand voltage	IEC 60664-1 <sup>1)</sup>	6000 V		4000 V			
Current rating	IEC 60512-5-2	16 A / + 55°C		12 A / + 55°C	13 A / + 55°C		
Contact resistance	IEC 60512-2-1	≤ 5 m Ω					
Insulation resistance	IEC 60512-3-1	≥ 10 <sup>8</sup> Ω					
Climatic Characteristics		Standard			Characteristics		
Climatic category	IEC 60068-1	40 / 100 / 56		40 / 125 / 56			
Operating temperature		-40°C ... +100°C		-40°C ... +125°C			
Mechanical Characteristics		Standard			Characteristics		
IP-degree	IEC 60529	IP 65 / IP 67					
Insertion and withdrawal forces	IEC 60512-13-2	≤ 15 N		≤ 30 N			
Mechanical operation	IEC 60512-9-1	≥ 500 mating cycles					
Materials		Standard			Characteristics		
Housing material		PA 6.6 / PA 6					
Dielectric material		PA 6.6 / PA 6					
Gasket material		Neopren					
Material lace for protective cover		TPE					
Contact plating		silver plating / gold plating					

Derating-Curves <sup>2)</sup>

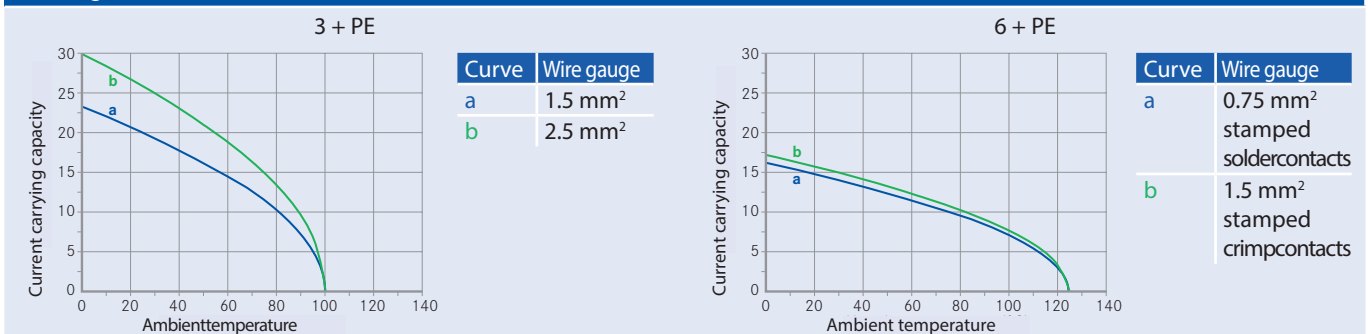

Remark

The stated technical values refer to the use as connector without breaking capacity (COC). If these components are used as plug and socket device a reduced current carrying capacity has to be considered. The characteristics have to be requested from the manufacturer.



Description	No. of contacts	Part number		Drawing	Figure
		Silver plating	Gold plating		

Male cable connector straight | strain relief with clamping ring 6 -12.5 mm

Screw blue black	3 + PE	C016 20H003 100 10	C016 20H003 200 10		
	3 + PE	C016 20H003 100 12	C016 20H003 200 12		
Solder blue black	6 + PE	C016 30H006 100 10	C016 30H006 200 10		
	6 + PE	C016 30H006 100 12	C016 30H006 200 12		
Crimp <sup>1)</sup> blue black	6 + PE	C016 10H006 000 10	C016 10H006 000 10		
	6 + PE	C016 10H006 000 12	C016 10H006 000 12		

Male cable connector straight | with internal cable clamping and clamping ring 6 - 10.0 mm

Screw blue black	3 + PE	C016 20H003 110 10	C016 20H003 210 10		
	3 + PE	C016 20H003 110 12	C016 20H003 210 12		
Solder blue black	6 + PE	C016 30H006 110 10	C016 30H006 210 10		
	6 + PE	C016 30H006 110 12	C016 30H006 210 12		
Crimp <sup>1)</sup> blue black	6 + PE	C016 10H006 010 10	C016 10H006 010 10		
	6 + PE	C016 10H006 010 12	C016 10H006 010 12		

Male cable connector angled | strain relief with clamping ring 6 -12.5 mm

Screw blue black	3 + PE	C016 20K003 100 10	C016 20K003 200 10		
	3 + PE	C016 20K003 100 12	C016 20K003 200 12		
Solder blue black	6 + PE	C016 30K006 100 10	C016 30K006 200 10		
	6 + PE	C016 30K006 100 12	C016 30K006 200 12		
Crimp <sup>1)</sup> blue black	6 + PE	C016 10K006 000 10	C016 10K006 000 10		
	6 + PE	C016 10K006 000 12	C016 10K006 000 12		

Male Receptacle

Screw black	3 + PE	C016 20C003 100 12	C016 20C003 200 12	A		
Solder black	6 + PE	C016 30C006 100 12	C016 30C006 200 12	14.0		
Crimp <sup>1)</sup> black	6 + PE	C016 10C006 000 12	C016 10C006 000 12	12.0		
				16.5		

Mounting Instruction<sup>2)</sup>

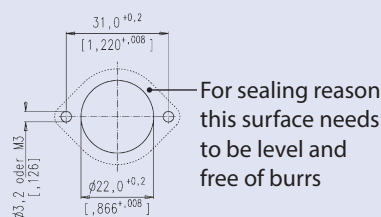

Description	No. of contacts	Part number		Drawing	Figure
		Silver plating	Gold plating		

Female cable connector straight | strain relief with clamping ring 6 -12.5 mm

Screw blue black	3 + PE	C016 20D003 100 10	C016 20D003 200 10		
	3 + PE	C016 20D003 100 12	C016 20D003 200 12		
Solder blue black	6 + PE	C016 30D006 100 10	C016 30D006 200 10		
	6 + PE	C016 30D006 100 12	C016 30D006 200 12		
Crimp <sup>1)</sup> blue black	6 + PE	C016 10D006 000 10	C016 10D006 000 10		
	6 + PE	C016 10D006 000 12	C016 10D006 000 12		

Female cable connector straight | with internal cable clamping and clamping ring 6 - 10.0 mm

Screw blue black	3 + PE	C016 20D003 110 10	C016 20D003 210 10		
	3 + PE	C016 20D003 110 12	C016 20D003 210 12		
Solder blue black	6 + PE	C016 30D006 110 10	C016 30D006 210 10		
	6 + PE	C016 30D006 110 12	C016 30D006 210 12		
Crimp <sup>1)</sup> blue black	6 + PE	C016 10D006 010 10	C016 10D006 010 10		
	6 + PE	C016 10D006 010 12	C016 10D006 010 12		

Female cable connector angled | strain relief with clamping ring 6 -12.5 mm

Screw blue black	3 + PE	C016 20F003 100 10	C016 20F003 200 10		
	3 + PE	C016 20F003 100 12	C016 20F003 200 12		
Solder blue black	6 + PE	C016 30F006 100 10	C016 30F006 200 10		
	6 + PE	C016 30F006 100 12	C016 30F006 200 12		
Crimp <sup>1)</sup> blue black	6 + PE	C016 10F006 000 10	C016 10F006 000 10		
	6 + PE	C016 10F006 000 12	C016 10F006 000 12		

Female Receptacle

Screw black	3 + PE	C016 20G003 100 12	C016 20G003 200 12	A		
Solder black	6 + PE	C016 30G006 100 12	C016 30G006 200 12	13.5		
Crimp <sup>1)</sup> black	6 + PE	C016 10G006 000 12	C016 10G006 000 12	14.2		
				16.5		

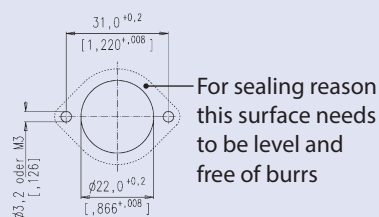

Mounting Instruction<sup>2)</sup>



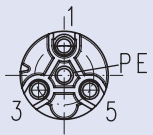
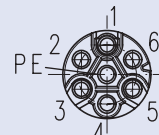
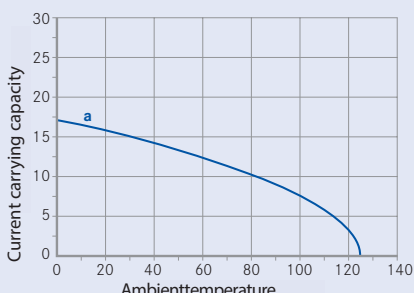

eco|mate<sup>m</sup>

High Voltage

General Characteristics		Standard	Characteristics					
Number of contacts			3 + PE	6 + PE				
Termination technique			crimp type					
Wire gauge / AWG			0.14 - 1.5 mm <sup>2</sup> AWG 26 - 16					
Flammability	UL 94		VO					
Locking system			round thread					
View on termination side of male contact insert								
Electrical Characteristics								
Rated voltage	IEC 60664-1 <sup>1)</sup>		600 V					
Pollution degree	IEC 60664-1 <sup>1)</sup>		3 (mated)					
Installation(overvoltage)category	IEC 60664-1 <sup>1)</sup>		III					
Material group	IEC 60664-1 <sup>1)</sup>		II					
Rated impulse withstand voltage	IEC 60664-1 <sup>1)</sup>		6000 V					
Current carrying capacity	IEC 60512-5-2		14 A / + 40°C					
Contact resistance	IEC 60512-2-1		≤ 5 m Ω					
Insulation resistance	IEC 60512-3-1		≥ 10 <sup>8</sup> Ω					
Climatic Characteristics								
Climatic category	IEC 60068-1		40 / 125 / 56					
Operating temperature			-40°C ... +125°C					
Mechanical Characteristics								
Degree of protection	IEC 60529		IP 65					
Insertion and withdrawal force	IEC 60512-13-2		≤ 35 N					
Mechanical operation	IEC 60512-9-1		≥ 500 mating cycles					
Materials								
Housing material			PA 6.6 / PA 6					
Dielectric material			PA 6.6 / PA 6					
Gasket material			Neopren					
Contact plating			silver plating / gold plating					
Derating-Curves <sup>2)</sup>		Prüfstelle	Kennwert					
<p>6 + PE</p>  <table border="1"> <thead> <tr> <th>Curve</th> <th>Wire gauge</th> </tr> </thead> <tbody> <tr> <td>a</td> <td>1.5 mm<sup>2</sup> stamped crimpcontacts</td> </tr> </tbody> </table>		Curve	Wire gauge	a	1.5 mm <sup>2</sup> stamped crimpcontacts	<p>UL * </p> <p>CSA </p>	<p>3+PE, 600 V, 13 A at AWG 16 3+PE, 600 V, 5 A at AWG 26 6+PE, 600 V, 13 A at AWG 16 6+PE, 600 V, 5 A at AWG 26</p> <p>3+PE, 600 V, 10.5 A at AWG 16 6+PE, 600 V, 10.5 A at AWG 16</p>	
Curve	Wire gauge							
a	1.5 mm <sup>2</sup> stamped crimpcontacts							
		<p>In general approvals refer to versions of the connector series. Test report upon request. * Please refer to „conditions of acceptability“</p>						

**Remark**

The stated technical values refer to the use as connector without breaking capacity (COC). If these components are used as plug and socket device a reduced current carrying capacity has to be considered. The characteristics have to be requested from the manufacturer.



Description	No. of contacts	Part number	Drawing	Figure
-------------	-----------------	-------------	---------	--------

Female cable connector straight | with clamping ring, cable diameter 6 -12.5 mm

Crimp <sup>1)</sup> black	3 + PE	C016 10D003 806 12		
	6 + PE	C016 10D006 806 12		

Male receptacle

Crimp <sup>1)</sup> black	3 + PE	C016 10P003 806 12		
	6 + PE	C016 10P006 806 12		

Mounting Instruction<sup>2)</sup>

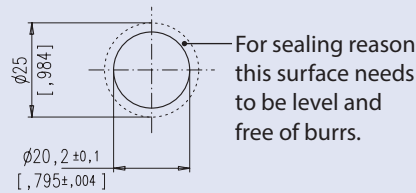

Remark









- Standard dust cups don't fit on high voltage versions special caps upon request.
- Thread size M 20 x 1.5
- If turn protection is required, we recommend to glue receptacles.

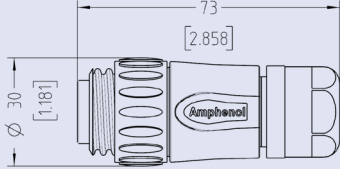

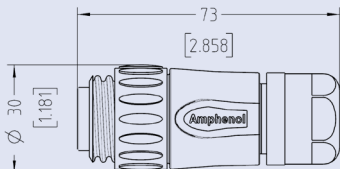
A close-up, perspective view of an industrial conveyor belt system. The central focus is a long, narrow conveyor belt with a blue mesh surface, extending from the foreground into the background. The belt is supported by a complex metal frame with various rollers and guides. To the right, a large green electric motor is mounted vertically, connected to the belt's drive mechanism. The background is a blurred industrial setting with bright overhead lights and other machinery.

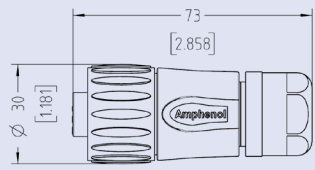
eco|mate<sup>m</sup>

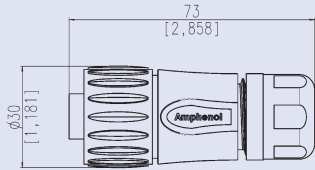
Special Types

Description	No. of contacts	Part number Silver plating	Drawing	Figure
<b>Male cable connector straight   with 4 pressure plates</b>				
Screw black <sup>1)</sup>	3 + PE	C016 20H003 804 12		
<b>Male cable connector straight   1 pressure plate at PE</b>				
Screw black <sup>1)</sup>	3 + PE	C016 20H003 803 12		
<b>Female cable connector straight   with 4 pressure plates</b>				
Screw black <sup>1)</sup>	3 + PE	C016 20D003 806 12		
<b>Female cable connector straight   with turned contacts</b>				
Screw black <sup>1)</sup>	6 + PE	C016 30D006 800 12		

Description	No. of contacts	Part number	Drawing	Figure
<b>Female receptacle   solder with turned contacts</b>				
black	6 + PE	C016 30G006 800 12		
<b>Female receptacle colored   6 + PE crimp<sup>1)</sup></b>				
yellow blue	6 + PE 6 + PE	T 3107 800 T 3107 802		
<b>Male receptacle   straight dip solder</b>				
black	3+ PE 6 + PE	T 3110 010 T 3106 010		
<b>Male receptacle   3 + PE solder with turned contacts</b>				
black	3+ PE	T 3110 100		

Supplied as	for wire gauge	Insulation Ø in mm	Pieces	Part number		Figure	
				Male contact	Female contact		
<b>Stamped single contacts 1.6 mm   6+PE</b>							
silver plating Standard	0.14 - 0.5 mm <sup>2</sup>	1.0 - 2.0	100	VN 01 016 0011 1	VN 02 016 0003 1		
	0.5 - 1.5 mm <sup>2</sup>	1.8 - 2.8	100	VN 01 016 0004 1	VN 02 016 0002 1		
silver plating High voltage	0.14 - 0.5 mm <sup>2</sup>	1.0 - 2.0	100	VN 01 016 0003 1	VN 02 016 0003 1		
	0.5 - 1.5 mm <sup>2</sup>	1.8 - 2.8	100	VN 01 016 0002 1	VN 02 016 0002 1		
gold plating Standard	0.14 - 0.5 mm <sup>2</sup>	1.0 - 2.0	100	VN 01 016 0011 2	VN 02 016 0003 2		
	0.5 - 1.5 mm <sup>2</sup>	1.8 - 2.8	100	VN 01 016 0004 2	VN 02 016 0002 2		
gold plating High voltage	0.14 - 0.5 mm <sup>2</sup>	1.0 - 2.0	100	VN 01 016 0003 2	VN 02 016 0003 2		
	0.5 - 1.5 mm <sup>2</sup>	1.8 - 2.8	100	VN 01 016 0002 2	VN 02 016 0002 2		
<b>Stamped contact on reel for hand crimping tools 1.6 mm   6+PE</b>							
silver plating Standard	0.14 - 0.5 mm <sup>2</sup>	1.0 - 2.0	200	ZN 01 016 0011 1	ZN 02 016 0003 1		
	0.5 - 1.5 mm <sup>2</sup>	1.8 - 2.8	200	ZN 01 016 0004 1	ZN 02 016 0002 1		
silver plating High voltage	0.14 - 0.5 mm <sup>2</sup>	1.0 - 2.0	200	ZN 01 016 0003 1	ZN 02 016 0003 1		
	0.5 - 1.5 mm <sup>2</sup>	1.8 - 2.8	200	ZN 01 016 0002 1	ZN 02 016 0002 1		
gold plating Standard	0.14 - 0.5 mm <sup>2</sup>	1.0 - 2.0	200	ZN 01 016 0011 2	ZN 02 016 0003 2		
	0.5 - 1.5 mm <sup>2</sup>	1.8 - 2.8	200	ZN 01 016 0004 2	ZN 02 016 0002 2		
gold plating High voltage	0.14 - 0.5 mm <sup>2</sup>	1.0 - 2.0	200	ZN 01 016 0003 2	ZN 02 016 0003 2		
	0.5 - 1.5 mm <sup>2</sup>	1.8 - 2.8	200	ZN 01 016 0002 2	ZN 02 016 0002 2		
<b>Stamped contact on reel for crimping machines contact feeding right hand side 1.6 mm   6+PE</b>							
silver plating Standard	0.14 - 0.5 mm <sup>2</sup>	1.0 - 2.0	2000	HN 01 016 0011 1	HN 02 016 0003 1		
	0.5 - 1.5 mm <sup>2</sup>	1.8 - 2.8	2000	HN 01 016 0004 1	HN 02 016 0002 1		
silver plating High voltage	0.14 - 0.5 mm <sup>2</sup>	1.0 - 2.0	2000	HN 01 016 0003 1	HN 02 016 0003 1		
	0.5 - 1.5 mm <sup>2</sup>	1.8 - 2.8	2000	HN 01 016 0002 1	HN 02 016 0002 1		
gold plating Standard	0.14 - 0.5 mm <sup>2</sup>	1.0 - 2.0	2000	HN 01 016 0011 2	HN 02 016 0003 2		
	0.5 - 1.5 mm <sup>2</sup>	1.8 - 2.8	2000	HN 01 016 0004 2	HN 02 016 0002 2		
gold plating High voltage	0.14 - 0.5 mm <sup>2</sup>	1.0 - 2.0	2000	HN 01 016 0003 2	HN 02 016 0003 2		
	0.5 - 1.5 mm <sup>2</sup>	1.8 - 2.8	2000	HN 01 016 0002 2	HN 02 016 0002 2		
<b>Stamped contact on reel for crimping machines contact feeding left hand side 1.6 mm   6+PE</b>							
silver plating Standard	0.14 - 0.5 mm <sup>2</sup>	1.0 - 2.0	2000	TN 01 016 0011 1	TN 02 016 0003 1		
	0.5 - 1.5 mm <sup>2</sup>	1.8 - 2.8	2000	TN 01 016 0004 1	TN 02 016 0002 1		
silver plating High voltage	0.14 - 0.5 mm <sup>2</sup>	1.0 - 2.0	2000	TN 01 016 0003 1	TN 02 016 0003 1		
	0.5 - 1.5 mm <sup>2</sup>	1.8 - 2.8	2000	TN 01 016 0002 1	TN 02 016 0002 1		
gold plating Standard	0.14 - 0.5 mm <sup>2</sup>	1.0 - 2.0	2000	TN 01 016 0011 2	TN 02 016 0003 2		
	0.5 - 1.5 mm <sup>2</sup>	1.8 - 2.8	2000	TN 01 016 0004 2	TN 02 016 0002 2		
gold plating High voltage	0.14 - 0.5 mm <sup>2</sup>	1.0 - 2.0	2000	TN 01 016 0003 2	TN 02 016 0003 2		
	0.5 - 1.5 mm <sup>2</sup>	1.8 - 2.8	2000	TN 01 016 0002 2	TN 02 016 0002 2		

Description	Part number	Figure
<b>Back shell right angled (Packaging units 10 pieces)</b>		
right angled with clamping ring		
blue	C016 G09 042 G10 X	
black	C016 G09 041 G10 X	
<b>Back shell straight (Packaging units 5 pieces)</b>		
colored back shells		
blue	C016 G11 042 E1 V	
black	C016 G11 041 E10 V	
red	C016 G11 043 E10 V	
white	C016 G11 044 E10 V	
green	C016 G11 045 E10 V	
yellow	C016 G11 046 E10 V	
orange	C016 G11 048 E10 V	
violet	C016 G11 060 E10 V	
brown	C016 G11 061 E10 V	
<b>Cable clamp (Packaging units 10 pieces)</b>		
for all straight cable connectors Cable clamp diameter Ø 6 - 10 mm	N 16 110 2000 X	
<b>Plugs brass</b>		
for 3+PE red	N 17 021 0001	
für 6+PE red	N 17 17 0001	
black	N 17 17 0001 1	

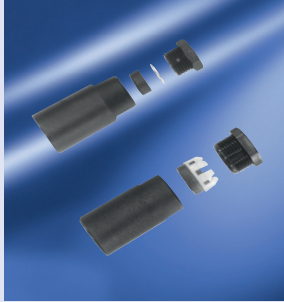
Description	Part number	Figure
Back shells (Packaging units 10 pieces)		
Back shell PG 9 with thrust collar	T 3102 003 7 X	
Back shell PG 11 with thrust collar	T 3102 004 7 X	
Back shell PG 13.5 with clamping ring	T 3102 005 7 X	
Rubber gasket		
for cable diameter 4-6mm <sup>2</sup>	N 06 007 0004	While mounting the rubber gasket for 4-6 mm <sup>2</sup> , the cable clamp shall be bolted with the convex section face-down in order to ensure the strain relief.

Description	Wire gauge	Contact locator	Part number	
			Crimping dies	Tool
Removal tool for crimp contacts	-	-	-	FG 0300 146 1
Hand crimp tools for single contacts	0.14 - 0.5 mm <sup>2</sup>	TA 0002 146 0001	TA 0000 202	TA 0500
	0.5 - 1.5 mm <sup>2</sup>	TA 0002 146 0001	TA 0000 163	TA 0500
Hand crimp tools for contacts on reel	0.14 - 0.5 mm <sup>2</sup>	-	-	TA 0700 203
	0.5 - 1.5 mm <sup>2</sup>	-	-	TA 0700 309

Description	Part number	Drawing	Figure
Protective covers for cable and receptacle housings			
formalecableconnector round cord	C016 00U000 010 12		
for male receptacle round cord	C016 00U000 000 12		
forfemalecableconnector round cord	C016 00V000 010 12		
for female receptacle round cord	C016 00V000 000 12		
formalecableconnector nylon cord	T 6482 000		
für male receptacle nylon cord	T 6482 001		
stainless steel cord	T 6482 008		
fürfemalecableconnector nylon cord	T 6483 000		
for female receptacle nylon cordr	T 6483 001		

Mounting of the protective covers on the back shell, male or female receptacles

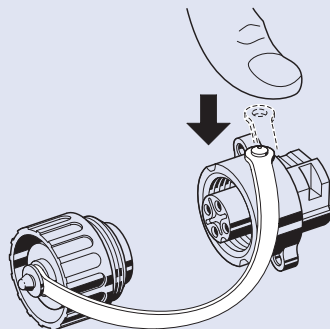

Mounting instruction, straight cable connector

Stripping lengths	Measure a <sup>1)</sup>	Measure b
Screw contacts with internal cable clamping	18 <sup>+1</sup>	7 <sup>+1 2)</sup>
without internal cable clamping	25 <sup>+1</sup>	7 <sup>+1 2)</sup>
Solder contacts with internal cable clamping	14 <sup>+1</sup>	4 <sup>+1</sup>
without internal cable clamping	22 <sup>+1</sup>	4 <sup>+1</sup>
Crimp contacts 0.14 – 0.50 mm <sup>2</sup>		3 <sup>+0.5</sup>
0.50 – 1.5 mm <sup>2</sup>		3.5 <sup>+1</sup>
with internal cable clamping	14 <sup>+1</sup>	
without internal cable clamping	22 <sup>+1</sup>	

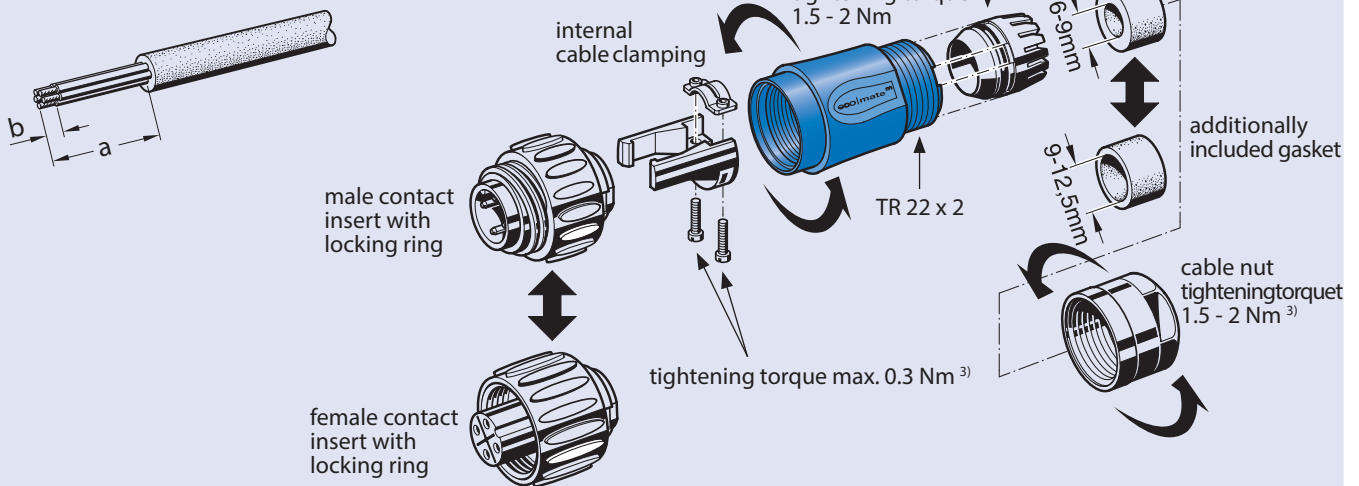

Mounting instruction, right angled cable connector

Stripping lengths	Measure a <sup>1)</sup>	Measure b
Screw contacts without internal cable clamping	35 <sup>+1</sup>	7 <sup>+1 2)</sup>
Solder contacts without internal cable clamping	32 <sup>+1</sup>	4 <sup>+1</sup>
Crimp contacts 0.14 – 0.5 mm <sup>2</sup>		3 <sup>+0.5</sup>
0.50 – 1.5 mm <sup>2</sup>		3.5 <sup>+1</sup>
without internal cable clamping	32 <sup>+1</sup>	

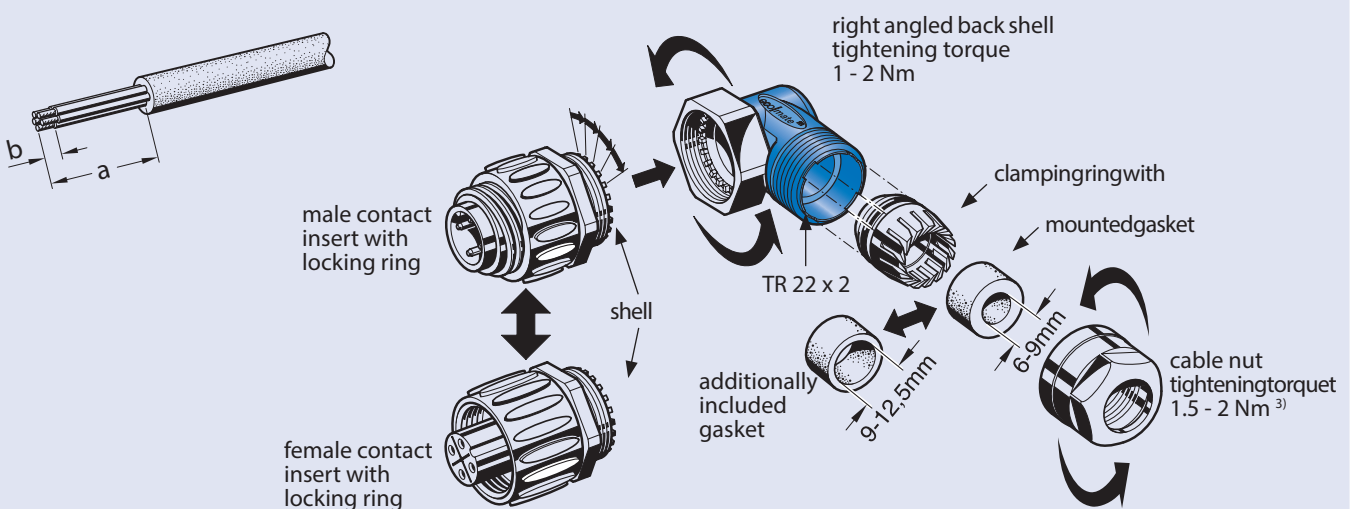

<sup>1)</sup> PE + 2 mm <sup>2)</sup> End splice recommended

<sup>3)</sup> The tightening torque figures can vary depending on the cable you use

Order Information	
Color coding	Crimp version
Backshells of cable connectors are available in different colors upon request. Min order quantity = 1000 pcs. per type.	Order number do not include crimp contacts. Please order separately (see page 20).
Mechanical coding	Crimp tooling
Achieved by special coding pins which are inserted into contact cavities. Min. order quantity = 1000 pcs. per type.	Ask for our catalogue "Tools".

Structure of part number						
C016	30	D	006	1	00	10
Series	Termination technique 10 = Crimp (6 + PE) 20 = Screw (3 + PE) 30 = Solder (6 + PE)	Style H = Male cable connector D = Female cable connector K = Right angled male cable connector F = Right angled female cable connector C = Male receptacle G = Female receptacle P = Male receptacle	No. of Poles 003 = 3 + PE 006 = 6 + PE	Contact Plating 1 = silver plating 2 = gold plating 0 = without contacts	Strain relief 00 = receptacle or cable connector with clamping ring 10 = cable connector with internal cable clamp	Version 10 = cable connector in blue/black 12 = cable or receptacle connector in blue

**Screw termination**

Screw clamps are designed acc. to EN 60999-1/VDE 06095.1. Chart 1 below shows the screw size depending on wire size and the required clamping and testing torque.

Diagram 1 below shows the range of tensile strength for a screw connection with a clamp screw M3, fastened with a torque of 50 Ncm, depending on the wire size.

Chart 1			Diagramm 1
Wire size (mm <sup>2</sup> )	1.5	2.5	
Screw size	M 3	M 3	
Test torque (Ncm)	max. 50	max. 50	

**Conversion AWG - mm<sup>2</sup>**

The comparison chart 2 below allows a cross reference between American Wire Gauge (AWG) and metric wire sizes (mm<sup>2</sup>).

AWG	Wire composition	Wire diameter	Wire size	AWG	Wire composition	Wire diameter	Wire size	
30	1 x 0.25	0.25 mm	0.05 mm <sup>2</sup>	20	1 x 0.81	0.81 mm	0.52 mm <sup>2</sup>	
	7 x 0.10	0.36 mm	0.06 mm <sup>2</sup>		7 x 0.32	0.97 mm	0.56 mm <sup>2</sup>	
28	1 x 0.32	0.32 mm	0.08 mm <sup>2</sup>	18	19 x 0.20	1.02 mm	0.62 mm <sup>2</sup>	
	7 x 0.13	0.38 mm	0.09 mm <sup>2</sup>		1 x 1.02	1.02 mm	0.79 mm <sup>2</sup>	
26	1 x 0.40	0.40 mm	0.13 mm <sup>2</sup>	16	19 x 0.25	1.27 mm	0.96 mm <sup>2</sup>	
	7 x 0.16	0.48 mm	0.14 mm <sup>2</sup>		19 x 0.29	1.44 mm	1.23 mm <sup>2</sup>	
	19 x 0.10	0.51 mm	0.15 mm <sup>2</sup>		14	19 x 0.36	1.80 mm	1.95 mm <sup>2</sup>
24	1 x 0.51	0.51 mm	0.21 mm <sup>2</sup>	12	19 x 0.46	2.29 mm	3.09 mm <sup>2</sup>	
	7 x 0.20	0.61 mm	0.23 mm <sup>2</sup>		10	37 x 0.40	3.10 mm	4.60 mm <sup>2</sup>
	19 x 0.13	0.64 mm	0.24 mm <sup>2</sup>			8	133 x 0.29	4.0 mm
22	1 x 0.64	0.64 mm	0.33 mm <sup>2</sup>	6	133 x 0.36		5.5 mm	13.5 mm <sup>2</sup>
	7 x 0.25	0.76 mm	0.36 mm <sup>2</sup>					
	19 x 0.16	0.81 mm	0.38 mm <sup>2</sup>					

It is to be noted that wires of the same AWG number but with different composition have slightly different mm<sup>2</sup>.

**Crimp Termination**

A crimp connection is a non-detachable electrical connection between a wire and a crimp contact produced with the crimp technology. Precise crimping dies which are matched to the crimp barrel and the wire size and a defined deformation result in a reliable electrical connection.

There are open crimp barrels (stamped contacts) and closed crimp barrels (turned contacts).

The main advantages of crimp connections are:

- Efficient termination of contacts
- Reproducible terminations achieve consistent electrical and mechanical results

The requirements for crimp connections are defined in IEC 60352 Part 2 / DIN EN 60352 Part 2.

An important point of the quality of a crimp connection is the achieved tensile strength of the termination.

Easily measured, the tensile strength is a practicable means for quality control purposes.

Diagram 2 below shows the required minimum tensile strength for open and closed barrels depending on the wire size

**Assembly Instructions**

For crimp contacts use the released crimp tool.

The insertion and extraction of crimp contacts shall only be approved with the corresponding insertion/extraction tool.

A detailed description of the crimp technology can be found in our crimp tooling catalogues.

Crimp contacts are in this catalogue on page 20.

**Diagramm 2**

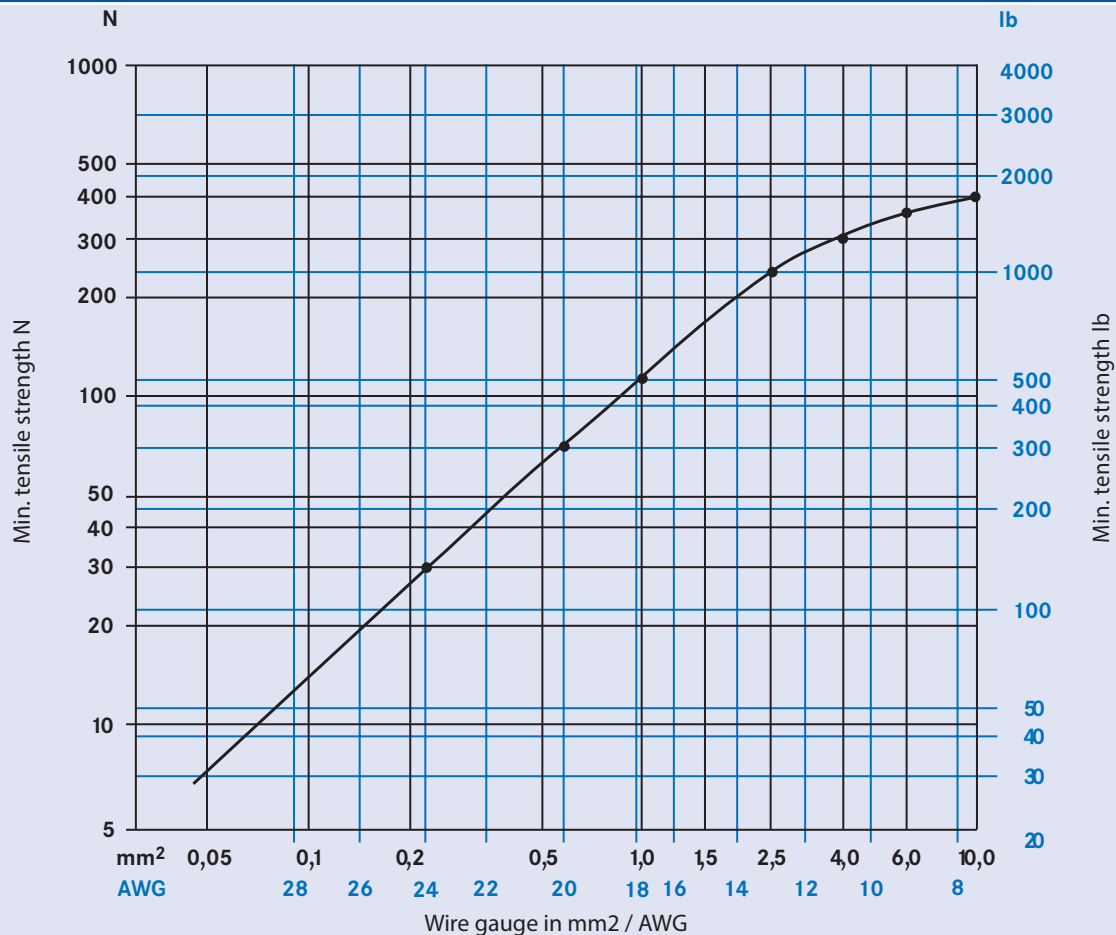

**Degree of Protection**

Electrical devices to which connectors belong to have to be protected for safety reasons from outside influences like dust, foreign objects, direct contact, moisture and water. This protection is provided on industrial connectors by its housings with their latching devices and sealed cable entries. The degree of protection can be selected depending on the type of intended use. The standard IEC 60529 and/or DIN EN 60529/VDE 0470 Part 1 has specified the degree of protection and divided into several classes.

The degree of protection is indicated in the following way:

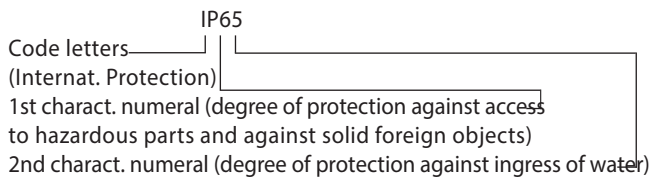

The following charts 3 and 4 give an overview about all protection degrees.

**Chart 3**

1st charact. numeral	Brief description	Definition
0	Non-protected	–
1	Protected against access to hazardous parts with the back of a hand. Protected against solid foreign objects of $\geq 50\text{mm } \varnothing$ .	The probe, sphere of 50mm $\varnothing$ , shall not fully penetrate and shall have adequate clearance from hazardous parts.
2	Protected against access to hazardous parts with a finger. Protected against solid foreign objects of $\geq 12.5\text{mm } \varnothing$ .	The jointed test finger of 12mm $\varnothing$ , 80mm length, shall have adequate clearance from hazardous parts. The probe, sphere of 12.5mm $\varnothing$ , shall not fully penetrate.
3	Protected against access to hazardous parts with a tool. Protected against solid foreign objects of $\geq 2.5\text{mm } \varnothing$ .	The probe of 2.5mm $\varnothing$ shall not penetrate at all.
4	Protected against access to hazardous parts with a wire. Protected against solid foreign objects of $\geq 1\text{mm } \varnothing$ .	The probe of 1mm $\varnothing$ shall not penetrate at all.
5	Protected against access to hazardous parts with a wire. Dust-protected.	The probe of 1mm $\varnothing$ shall not penetrate. Intrusion of dust is not totally prevented, but dust shall not penetrate in a quantity to interfere with satisfactory operation of the device or to impair safety.
6	Protected against access to hazardous parts with a wire. Dust-tight.	The probe of 1mm $\varnothing$ shall not penetrate. No intrusion of dust.

**Chart 4**

2nd charact. numeral	Brief description	Definition
0	Non-protected	--
1	Protected against vertically falling water drops	Vertically falling drops shall have no harmful effects.
2	Protected against vertically falling water drops when enclosure tilted up to 15°	Vertically falling drops shall have no harmful effects when the enclosure is tilted at any angle up to 15° on either side of the vertical.
3	Protected against spraying water	Water sprayed at an angle up to 60° on either side of the vertical shall have no harmful effects
4	Protected against splashing water	Water splashed against the enclosure from any direction shall have no harmful effects.
5	Protected against water jets	Water projected in jets against the enclosure from any direction shall have no harmful effects.
6	Protected against powerful water jets	Water projected in powerful jets against the enclosure from any direction shall have no harmful effects.
7	Protected against the effects of temporary immersion in water	Intrusion of water in quantities causing harmful effects shall not be possible when the enclosure is temporarily immersed in water for 30 min. in 1m depth.
8	Protected against the effects of continuous immersion in water	Intrusion of water in quantities causing harmful effects shall not be possible when the enclosure is continuously immersed in water under conditions which shall be agreed between manufacturer and user but which are more severe than for numeral 7.
9K <sup>1)</sup>	Protected against water during high pressure/steam jet cleaning	Water projected in powerful jets with high pressure against the enclosure from any direction shall have no harmful effects.



### 1. General Remarks

These connectors are designed and produced in conformity with the low voltage directive (73/23/EWG) respectively Gerätesicherheitsgesetz (German law) and are especially in accordance with the standards DIN EN 61984 / IEC 61984 (VDE 0627); IEC 60664-1 (VDE 0110-1) and IEC 60529.

The connectors may be used only within the technical ratings. All technical data refer to mated connectors under live conditions. The safety of the connector system depends on the correct selection of products, proper assembly of the connector device and a precise fit of the connectors

### 2. Application Remarks

Connectors with / without breaking capacity must be used according to specified technical ratings.

The technical data represents the initial value of mated parts under predetermined conditions and length of time. These values could change with different test parameters or product requirements.

The connectors of the series are designed for the areas of application including the construction and installation of controlling and electrical devices.

The product has been tested for the intended purposes only. If the connection is used other than originally intended, or in another manner that we have not previously tested, the consumer assumes full responsibility.

All rated data for the connectors listed in this catalogue are based on overvoltage

category III and pollution degree 3 for electronic applications if not stated differently. Connectors were completely mated according to their respective safety locking mechanism. Selection and testing of connectors with / without breaking capacity to meet specific product or industrial requirements such as rated voltage and the related clearances and creepage distances are the responsibility of the user.

### 3. Assembling Remarks

Protection against electrical shock of the termination of the connectors shall be secured by correct mounting. Connectors of the same or different series being mounted side by side may be protected against incorrect mating by the use of coding options. Care must be taken to ensure the parts are correctly mated and screws are tightened with the proper torque.

### 4. Termination Remarks

Cable connectors are effectively secured when using the strain relief (internal clamping ring). All cable properties or specifications must be compatible with the connector design and materials.

Please make sure that the usability of the cable in conjunction with the clamping ring is given.

Designated wire conductors must be terminated to the correct poles in the connector.

Crimp contacts must be fully inserted into the plastic housing and strain relief assured with a slight tug on the wire.

Wire should be stripped correctly according to printed specifications to insure no electrical contact can be made between the conductors. There should be no nicked or cut strains during the stripping action.

Bestellnummer	Seite	Bestellnummer	Seite	Bestellnummer	Seite	Bestellnummer	Seite
C016 00U000 000 12	23	C016 20H003 804 12	18	HN 02 016 0003 2	20	ZN 01 016 0003 2	20
C016 00U000 010 12	23	C016 20K003 100 10	12	N 06 007 0004	22	ZN 01 016 0004 1	20
C016 00V000 000 12	23	C016 20K003 100 12	12	N 16 110 2000 X	21	ZN 01 016 0004 2	20
C016 00V000 010 12	23	C016 20K003 200 10	12	N 17 17 0001	21	ZN 01 016 0011 1	20
C016 10C006 000 12	12	C016 20K003 200 12	12	N 17 17 0001 1	21	ZN 01 016 0011 2	20
C016 10C006 000 12	12	C016 30C006 100 12	12	N 17 021 0001	21	ZN 02 016 0002 1	20
C016 10D003 806 12	16	C016 30C006 200 12	12	T 3102 003 7 X	22	ZN 02 016 0002 1	20
C016 10D006 000 10	13	C016 30D006 100 10	13	T 3102 004 7 X	22	ZN 02 016 0002 2	20
C016 10D006 000 10	13	C016 30D006 100 12	13	T 3102 005 7 X	22	ZN 02 016 0002 2	20
C016 10D006 000 12	13	C016 30D006 110 10	13	T 3106 010	19	ZN 02 016 0003 1	20
C016 10D006 000 12	13	C016 30D006 110 12	13	T 3107 800	19	ZN 02 016 0003 1	20
C016 10D006 010 10	13	C016 30D006 200 10	13	T 3107 802	19	ZN 02 016 0003 2	20
C016 10D006 010 10	13	C016 30D006 200 12	13	T 3110 010	19	ZN 02 016 0003 2	20
C016 10D006 010 12	13	C016 30D006 210 10	13	T 3110 100	19		
C016 10D006 010 12	13	C016 30D006 210 12	13	T 6482 000	23		
C016 10D006 806 12	16	C016 30D006 800 12	18	T 6482 001	23		
C016 10F006 000 10	13	C016 30F006 100 10	13	T 6482 008	23		
C016 10F006 000 10	13	C016 30F006 100 12	13	T 6483 000	23		
C016 10F006 000 12	13	C016 30F006 200 10	13	T 6483 001	23		
C016 10F006 000 12	13	C016 30F006 200 12	13	TA 0000 163	22		
C016 10G006 000 12	13	C016 30G006 100 12	13	TA 0000 202	22		
C016 10G006 000 12	13	C016 30G006 200 12	13	TA 0002 146 0001	22		
C016 10H006 000 10	12	C016 30G006 800 12	19	TA 0002 146 0001	22		
C016 10H006 000 10	12	C016 30H006 100 10	12	TA 0500	22		
C016 10H006 000 12	12	C016 30H006 100 12	12	TA 0500	22		
C016 10H006 000 12	12	C016 30H006 110 10	12	TA 0700 203	22		
C016 10H006 010 10	12	C016 30H006 110 12	12	TA 0700 309	22		
C016 10H006 010 10	12	C016 30H006 200 10	12	TN 01 016 0002 1	20		
C016 10H006 010 12	12	C016 30H006 200 12	12	TN 01 016 0002 2	20		
C016 10H006 010 12	12	C016 30H006 210 10	12	TN 01 016 0003 1	20		
C016 10K006 000 10	12	C016 30H006 210 12	12	TN 01 016 0003 2	20		
C016 10K006 000 10	12	C016 30K006 100 10	12	TN 01 016 0004 1	20		
C016 10K006 000 12	12	C016 30K006 100 12	12	TN 01 016 0004 2	20		
C016 10K006 000 12	12	C016 30K006 200 10	12	TN 01 016 0011 1	20		
C016 10P003 806 12	16	C016 30K006 200 12	12	TN 01 016 0011 2	20		
C016 10P006 806 12	16	C016 G09 041 G10 X	21	TN 02 016 0002 1	20		
C016 20C003 100 12	12	C016 G09 042 G10 X	21	TN 02 016 0002 1	20		
C016 20C003 200 12	12	C016 G11 041 E10 V	21	TN 02 016 0002 2	20		
C016 20D003 100 10	13	C016 G11 042 E1 V	21	TN 02 016 0002 2	20		
C016 20D003 100 12	13	C016 G11 043 E10 V	21	TN 02 016 0003 1	20		
C016 20D003 110 10	13	C016 G11 044 E10 V	21	TN 02 016 0003 1	20		
C016 20D003 110 12	13	C016 G11 045 E10 V	21	TN 02 016 0003 2	20		
C016 20D003 200 10	13	C016 G11 046 E10 V	21	TN 02 016 0003 2	20		
C016 20D003 200 12	13	C016 G11 048 E10 V	21	VN 01 016 0002 1	20		
C016 20D003 210 10	13	C016 G11 060 E10 V	21	VN 01 016 0002 2	20		
C016 20D003 210 12	13	C016 G11 061 E10 V	21	VN 01 016 0003 1	20		
C016 20D003 806 12	18	FG 0300 146 1	22	VN 01 016 0003 2	20		
C016 20F003 100 10	13	HN 01 016 0002 1	20	VN 01 016 0004 1	20		
C016 20F003 100 12	13	HN 01 016 0002 2	20	VN 01 016 0004 2	20		
C016 20F003 200 10	13	HN 01 016 0003 1	20	VN 01 016 0011 1	20		
C016 20F003 200 12	13	HN 01 016 0003 2	20	VN 01 016 0011 2	20		
C016 20G003 100 12	13	HN 01 016 0004 1	20	VN 02 016 0002 1	20		
C016 20G003 200 12	13	HN 01 016 0004 2	20	VN 02 016 0002 1	20		
C016 20H003 100 10	12	HN 01 016 0011 1	20	VN 02 016 0002 2	20		
C016 20H003 100 12	12	HN 01 016 0011 2	20	VN 02 016 0002 2	20		
C016 20H003 110 10	12	HN 02 016 0002 1	20	VN 02 016 0003 1	20		
C016 20H003 110 12	12	HN 02 016 0002 1	20	VN 02 016 0003 1	20		
C016 20H003 200 10	12	HN 02 016 0002 2	20	VN 02 016 0003 2	20		
C016 20H003 200 12	12	HN 02 016 0002 2	20	VN 02 016 0003 2	20		
C016 20H003 210 10	12	HN 02 016 0003 1	20	ZN 01 016 0002 1	20		
C016 20H003 210 12	12	HN 02 016 0003 1	20	ZN 01 016 0002 2	20		
C016 20H003 803 12	18	HN 02 016 0003 2	20	ZN 01 016 0003 1	20		





# International

## Argentinien

Amphenol Argentina  
Av. Callao 930  
2nd Floor Office B "Plaza"  
C1023 AAP Buenos Aires  
Telefon +54 11 4815 68 86  
www.amphenol.com.ar

## Australien

Amphenol Australia Pty. Ltd.  
2 Fiveways Blvd  
Keysborough  
Victoria 31 73  
Telefon +61 3 8796 88 88  
www.amphenol.com.au

## Brasilien

Amphenol do Brasil Ltda.  
Rua Diogo Moreira 132, 20th Floor  
CEP 05423-101 Sao Paulo SP  
Telefon +55 11 3815 10 03  
www.amphenol.com.br

## China

Amphenol-Tuchel Electronics  
China Branch  
20 Tianshan Road  
Changzhou 213022  
Telefon +86 519 85 11 03 01  
www.amphenol.info

## Deutschland

Amphenol-Tuchel Electronics GmbH  
August-Häusser-Str. 10  
74080 Heilbronn  
Telefon +49 7131 929 0  
www.amphenol.de

## England

Amphenol Limited  
Thanet Way, Whitstable  
Kent, CT53JF  
Telefon +44 1227 773 200  
www.amphenol.co.uk

## Frankreich

Amphenol Socapex S.A.S.  
948, Promenade de l'Arve, BP 29  
Thyez Cedex, 74311  
Telefon +33 4 5089 28 00  
www.amphenol-socapex.com

## Indien

Amphenol Interconnect India Pvt Ltd  
105, Bhosari Industrial Area  
Pune - 411 026  
Telefon +91 20 2712 04 81  
www.amphenol-in.com

## Italien

Amphenol-Tuchel Italy  
Via Barbaiana n. 5  
20020 Lainate (MI)  
Telefon +39 02 9325 41  
www.amphenol.info

## Korea

Amphenol DaeShin Elect and  
Precision Co.,Ltd  
558 Songnae-Dong, Sosa-Gu  
Bucheon-City, Kyunggi-Do  
Korea 422-130  
Telefon +82 32 6103 800  
www.amphenol.co.kr

## Mexiko

Amphenol Mexico  
Prolongacion Reforma 61 - 6 B2  
Col. Paseo de las Lomas  
C.P. 01330 Mexico D.F.  
Telefon +52 55 5258 99 84  
www.amphenolmexico.com

## Singapur

Asia Pacific Sales Operations  
72 Bendemeer Rd, No.03-32/33  
Hiap Huat House, Luzerne, 339941  
Singapore  
Telefon +65 6294 2128  
www.amphenol.com

## Spanien

Amphenol Espana  
Edificio Burgosol, Oficina 55  
C/Comunidad de Madrid, 35 bis  
Las Rozas (Madrid), 28230  
Telefon +34 91 6407 302  
www.amphenol.com

## Südafrika

Amphenol International Ltd  
Chislehurst  
30 Impala Road  
2196 Chislehurst  
Sandton, 2146  
Telefon +27 11 7839 517  
www.amphenol.co.za

## Taiwan

Amphenol East Asia Limited-Taiwan  
5F, No. 361, Fusing 1st Rd  
Gueishan Township,  
Taoyuan County 333  
Telefon +886 3 2647 200  
www.amphenol.com

Amphenol LTW Technology Co., Ltd.  
9F, No. 657-12, Zhongzheng Road  
Xinzhuan Dist., New Taipei City  
242 Taiwan  
Telefon +886 2 2908 5626  
sales@ltw-tech.com  
www.amphenolltw.com

## Türkei

Amphenol Turkey  
Sun Plaza Kat: 15  
Maslak Mah. Bilim Sok.No:15  
34398 Sisli - Istanbul  
Telefon +90 2123 679 220  
www.amphenol.com.tr

## USA

Amphenol-Tuchel Electronics /  
Amphenol Sine Systems  
44724 Morley Drive  
48036 Clinton Township, MI  
Telefon +1 586 913 8630  
www.amphenol.info

Amphenol Corporation  
Corporate Headquarters  
358 Hall Avenue  
Wallingford, CT 06492  
Telefon +1 877 2674 366  
Telefon +1 203 2658 900  
www.amphenol.com

More Amphenol companies can be  
found here: [www.amphenol.com](http://www.amphenol.com)



### Important Notice

All technical data have been measured in a laboratory environment and can be different during practical usage of the product. Any product information is for descriptive usage only and not legally binding; particularly the information does not constitute or provide any legal guaranties ("Beschaffenheitsgarantie" or "Haltbarkeitsgarantie").

We reserve the right to change the design due to improvement in quality, development or production requirements. This catalogue must not be used in any form or manner without our prior approval in writing (Copyright Law, Fair Trading Law, Civil Code).

Your engineering sales representative:

## Looking for pricing, stock, or lifecycle information?

Click below to explore more details on WIN SOURCE:

 [View C016 20H003 210 12 on WIN SOURCE](#)

 [Amphenol Information](#)

## Optimize Your Supply Chain with WIN SOURCE Solutions

-  Global Sourcing Solution
-  Obsolete Management
-  Cost Control Management
-  Shortage Management
-  Alternative Solution
-  Excess Inventory Management