



**THE DATASHEET OF
967-015-CAP**



MATERIAL & FINISH:

BACKSHELL: ABS - UL HB RATED, BLACK COLOR
 BUSHING & BAFFLE: SILICONE
 THUMBSCREWS: BRASS, NICKEL PLATED
 ABS TEMPERATURE: -0°C TO 80°C
 SILICON TEMPERATURE: -35°C TO 116°C

MATING PARAMETERS:
 RECOMMENDED MAX TORQUE: 40 in-oz
 NOMINAL GASKET COMPRESSION: 0.055"

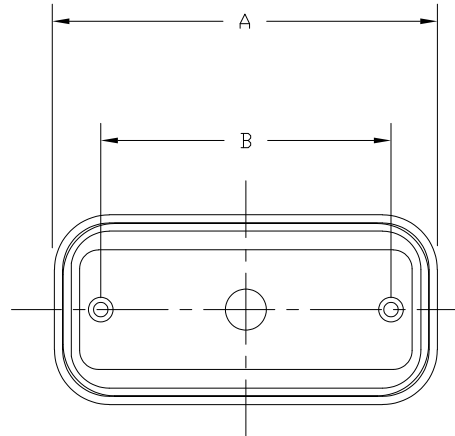
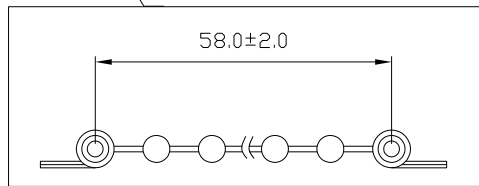
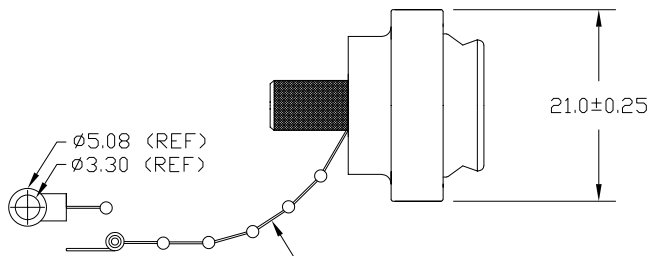
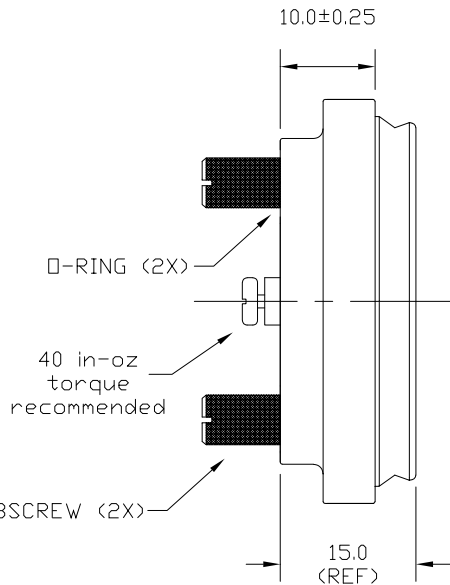

DIMENSIONS(mm)		
SIZE	A±0.25	B±0.25
9	42.0	25.0
15	50.3	33.3
25	64.0	47.0
37	80.5	63.4

SERIES _____ **967-YYY-CAP**

POSITIONS _____

009 (ALSO FITS 15P HIGH DENSITY)
015 (ALSO FITS 26P HIGH DENSITY)
025 (ALSO FITS 44P HIGH DENSITY)
037 (ALSO FITS 62P HIGH DENSITY)

RoHS COMPLIANT



THESE DRAWINGS AND SPECIFICATIONS ARE THE PROPERTY OF NorComp AND SHALL NOT BE REPRODUCED, COPIED OR USED AS THE BASIS FOR THE MANUFACTURE OR SALE OF APPARATUS WITHOUT WRITTEN PERMISSION.

DRAWN:
P. JENKINS

DATE:
07/21/2011

UNITS = mm

DO NOT SCALE FROM DRAWING

NorComp

SCALE:
 NTS

SHEET OF
 1 1

REV
 6

DWG NO.

967-YYY-CAP

Looking for pricing, stock, or lifecycle information?

Click below to explore more details on WIN SOURCE:

 [View 967-015-CAP on WIN SOURCE](#)

 [NorComp Inc. Information](#)

Optimize Your Supply Chain with WIN SOURCE Solutions

-  Global Sourcing Solution
-  Obsolete Management
-  Cost Control Management
-  Shortage Management
-  Alternative Solution
-  Excess Inventory Management