



**THE DATASHEET OF
NJM2360AM-TE2**



HIGH PRECISION DC/DC CONVERTOR CONTROL IC

■ GENERAL DESCRIPTION

The NJM2360A is a control circuit containing the primary functions required for DC to DC CONVERTOR.

This device consist of high precision reference, comparator controlled duty cycle oscillator with an active current limit circuit, driver and high current output switch.

This IC was specifically designed to be incorporated in step-up, step-down and inverting applications with a minimum number of external components. This IC is designed to be $\pm 5\%$ output voltage by using precision 1% resistance on external detected resistance.

■ PACKAGE OUTLINE

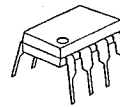

NJM2360AD

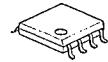

NJM2360AM

■ FEATURES

- Operating Voltage (2.5V~40V)
- Precision $\pm 2\%$ Reference
- Low Standby Current
- Output Voltage V_{OR} 1.25~40V
- Oscillator Frequency f_{OSC} 100Hz~100kHz
- Output Switch Current to 1.5A
- Package Outline DIP8, DMP8
- Bipolar Technology

■ PIN COFIGURATION

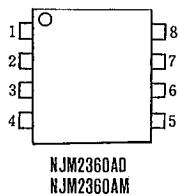

PIN FUNCTION

1. C_S
2. E_S
3. C_T
4. GND
5. INV_{IN}
6. V^+
7. S_I
8. C_D

■ BLOCK DIAGRAM

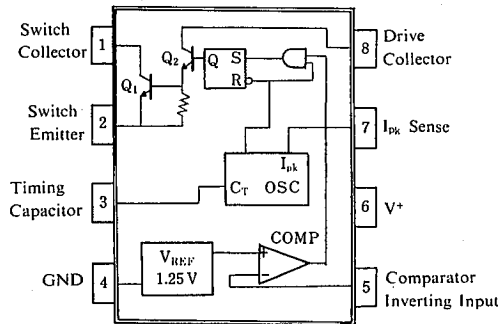

■ ABSOLUTE MAXIMUM RATINGS

(Ta=25°C)

PARAMETER	SYMBOL	RATINGS	UNIT
Supply Voltage	V*	40	V
Comparator Input Voltage Range	V _{IR}	-0.3~40	V
Power Dissipation	P _D	(DIP8) 875	mW
		(DMP8) 750(note 1)	mW
Switch Current	I _{sw}	1.5	A
Operating Temperature Range	T _{opr}	-40~+85	°C
Storage Temperature Range	T _{stg}	-40~+150	°C

(note 1) At on PC board

■ ELECTRICAL CHARACTERISTICS

- DC Characteristics (V*=5V, Ta=25°C)

PARAMETER	SYMBOL	TEST CONDITION	MIN.	TYP.	MAX.	UNIT
Operating Current	I _{CC}	5V ≤ V* ≤ 40V, C _T =0.001μF S _I =V*, INV _{IN} >V _{th} , E _S =GND	—	2.4	3.5	mA

Oscillator

Charge Current	I _{chg}	5V ≤ V* ≤ 40V	20	35	50	μA
Discharge Current	I _{dischg}	5V ≤ V* ≤ 40V	150	200	250	μA
Voltage Swing	V _{osc}		—	0.5	—	V _{P-P}
Discharge to Charge Current Ratio	I _{dischg} /I _{chg}	S _I =V*	—	6	—	—
Peak Current Sense Voltage	V _{IPK(sense)}	I _{chg} =I _{dischg}	250	300	350	mV

Output Switch (Note 2)

Saturation Voltage 1	V _{CE(sat)1}	Darlington Connection (C _S =C _D) I _{sw} =1.0A	—	1.0	1.3	V
Saturation Voltage 2	V _{CE(sat)2}	I _{sw} =1.0A, I _{C(driver)} =50mA (Forced β≅20)	—	0.5	0.7	V
DC Current Gain	h _{FE}	I _{sw} =1.0A, V _{CE} =5.0V	35	120	—	—
Collector Off-State Current	I _{C(off)}	V _{CE} =40V	—	10	—	nA

Comparator

Threshold Voltage	V _{th}		1.225	1.250	1.275	V
Input Bias Current	I _{IB}	V _{IN} =OV	—	40	400	nA

Note 2 : Output switch tests are performed under pulsed conditions to minimize power dissipation.

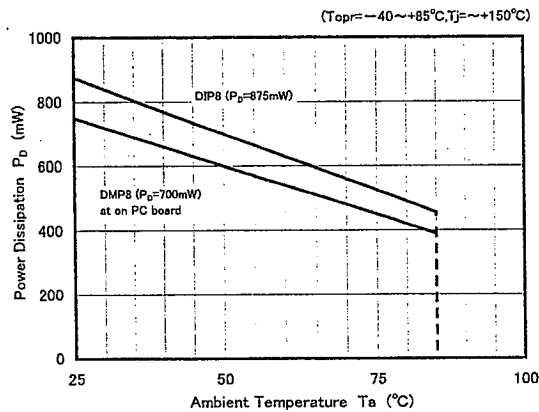



MEMO

[CAUTION]

The specifications on this databook are only given for information, without any guarantee as regards either mistakes or omissions. The application circuits in this databook are described only to show representative usages of the product and not intended for the guarantee or permission of any right including the industrial rights.

Looking for pricing, stock, or lifecycle information?

Click below to explore more details on WIN SOURCE:

-  [View NJM2360AM-TE2 on WIN SOURCE](#)
-  [Nisshinbo Micro Devices Inc. Information](#)

Optimize Your Supply Chain with WIN SOURCE Solutions

-  Global Sourcing Solution
-  Obsolete Management
-  Cost Control Management
-  Shortage Management
-  Alternative Solution
-  Excess Inventory Management