



THE DATASHEET OF
0035.1351



LED Holder straight or angled with 3 mm and 5 mm LED



LED green angled



LED red angled



See below:
[Approvals and Compliances](#)

Description

- Frontpanel and PCB Mounting
- Terminals angled or straight
- For 3 mm or 5 mm LED's

Weblinks

[pdf data sheet](#), [html datasheet](#), [CAD-Drawings](#), [Detailed request for product](#)

Technical Data

Climatical Data

Allowable Operation Temp.	-25 to 85 °C
Storage Temperature	-55 to 100 °C

Soldering Data

Solderability	235 °C / 2 sec acc. to IEC 60068-2-20 , Test Ta, method 1
Resistance to Soldering Heat	260 °C / 5 sec acc. to IEC 60068-2-20 , Test Tb, method 1A

Material

Socket	Thermoplastic
--------	---------------

LED

LED	Technical data LED see separate table
-----	---------------------------------------

Technical Data LED

	LED red	LED green	LED yellow
Let-through current DC IF max.	30 mA	30 mA	30 mA
Power Loss PV max.	100 mW	100 mW	100 mW
Forward voltage	typ. 2.0 V; max. 3.0 V	typ. 2.4 V; max. 3.0 V	typ. 2.4 V; max. 3.0 V
Luminous intensity	min. 6.3 mcd; typ. 10 mcd	min. 6.3 mcd; typ. 10 mcd	min. 6.3 mcd; typ. 12 mcd
Viewing angle	60°	60°	60°
Peak wave length	typ. 635 nm	typ. 565 nm	typ. 585 nm
Reverse voltage	typ. 15 V	typ. 15 V	typ. 15 V

Approvals and Compliances

Detailed information on product approvals, code requirements, usage instructions and detailed test conditions can be looked up in [Details about Approvals](#)

SCHURTER products are designed for use in industrial environments. They have approvals from independent testing bodies according to national and international standards. Products with specific characteristics and requirements such as required in the automotive sector according to IATF 16949, medical technology according to ISO 13485 or in the aerospace industry can be offered exclusively with customer-specific, individual agreements by SCHURTER.

Compliances

The product complies with following Guide Lines

Identification	Details	Initiator	Description
	RoHS	SCHURTER AG	Directive RoHS 2011/65/EU, Amendment (EU) 2015/863
	REACH	SCHURTER AG	On 1 June 2007, Regulation (EC) No 1907/2006 on the Registration, Evaluation, Authorization and Restriction of Chemicals 1 (abbreviated as "REACH") entered into force.

Dimension [mm]

SRL straight 3 mm

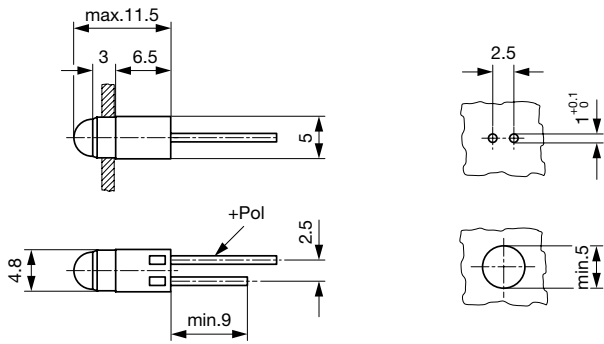

SRL straight 5 mm

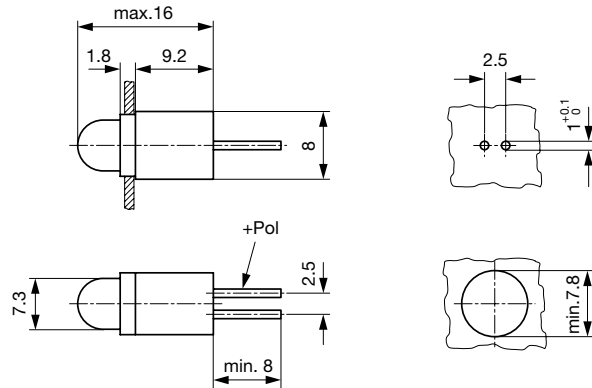

SRL angled, crosswise contacts 3 mm

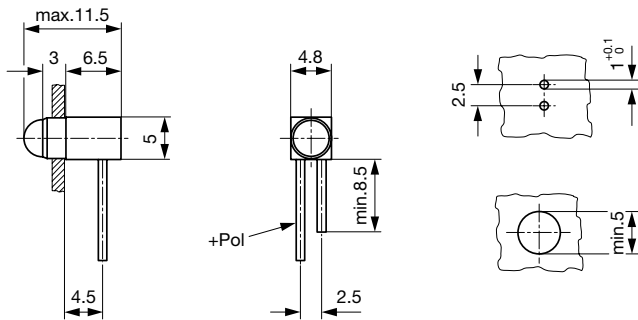

SRL angled, crosswise contacts 5 mm

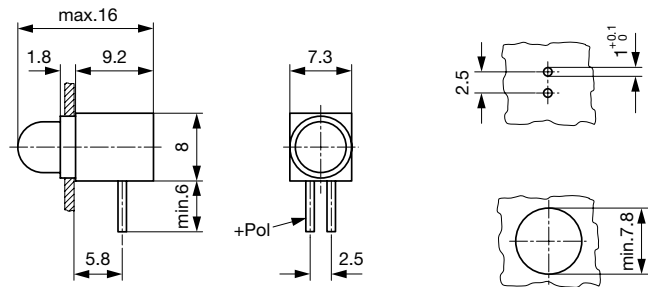

SRL angled, lengthwise contacts 3 mm

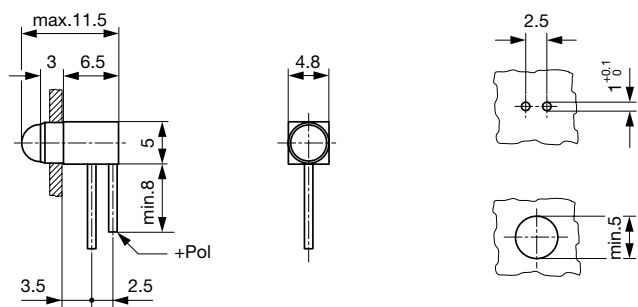

SRL angled, lengthwise contacts 5 mm

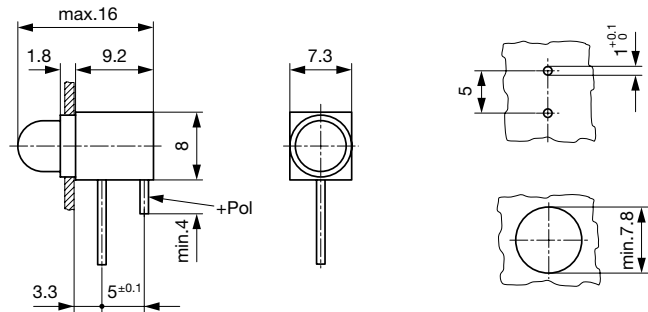

Variants

Diameter LED	Terminal direction	Color LED	Order Number
5 mm	straight	green	0035.1261
5 mm	straight	yellow	0035.1262
5 mm	angled - crosswise to the illumination axis	red	0035.1270
5 mm	angled - crosswise to the illumination axis	green	0035.1271
5 mm	angled - crosswise to the illumination axis	yellow	0035.1272
5 mm	angled - lengthwise to the illumination axis	red	0035.1280
5 mm	angled - lengthwise to the illumination axis	green	0035.1281
5 mm	angled - lengthwise to the illumination axis	yellow	0035.1282
3 mm	straight	red	0035.1340
3 mm	straight	green	0035.1341
3 mm	straight	yellow	0035.1342
3 mm	angled - crosswise to the illumination axis	red	0035.1350
3 mm	angled - crosswise to the illumination axis	green	0035.1351
3 mm	angled - crosswise to the illumination axis	yellow	0035.1352
3 mm	angled - lengthwise to the illumination axis	red	0035.1360
3 mm	angled - lengthwise to the illumination axis	green	0035.1361
3 mm	angled - lengthwise to the illumination axis	yellow	0035.1362
3 mm	-	without	0035.1370

Availability for all products can be searched real-time: <https://www.schurter.com/en/info-center/support-tools/stock-check-distributors>

Packaging unit 100 pcs

Looking for pricing, stock, or lifecycle information?

Click below to explore more details on WIN SOURCE:

 [View 0035.1351 on WIN SOURCE](#)

 [Schurter Inc. Information](#)

Optimize Your Supply Chain with WIN SOURCE Solutions

-  Global Sourcing Solution
-  Obsolete Management
-  Cost Control Management
-  Shortage Management
-  Alternative Solution
-  Excess Inventory Management