

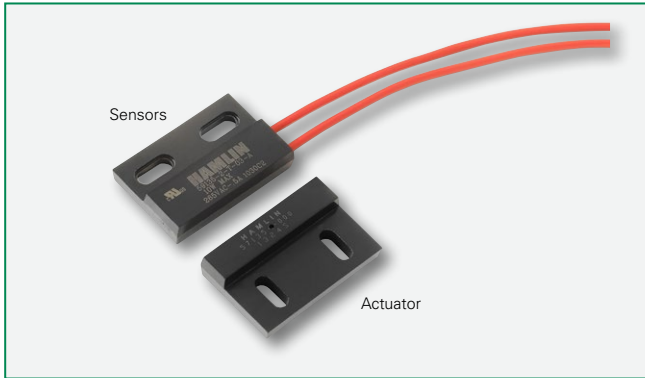

THE DATASHEET OF
59135-2-T-02-A



59135 High Temperature Flange Mount Sensor + 57135 Actuator



Description

The 59135 is a high temperature flange mounting reed sensor 28.57mm x 19.05mm x 6.35mm (1.125" x 0.750" x 0.259") with a choice of normally open, normally open high voltage, normally closed or changeover contacts. It's case design enables screw or adhesive mounting. It is rated for operation up to 150°C. It is capable of switching up to 265Vac/300Vdc at 10VA. The 59135 functions best with the matching actuator 57135-000.

Note: The 57135 Actuator is sold separately.

Features

- Two-part magnetically operated proximity sensor
- High temperature rated
- Cross-slotted mounting holes for optimum adjustability
- Customer defined sensitivity option
- Choice of cable length and connector
- Thermoset overmold material
- Teflon insulated wires

Benefits

- Hermetically sealed, magnetically operated contacts continue to operate long after optical and other technologies fail due to contamination
- No standby power requirement
- Operates through non-ferrous materials such as wood, plastic or aluminium

Agency Approvals

Agency	Agency File Number
	E61760

Note: Contact Littelfuse for specific agency approval ratings.

Dimensions

Dimensions in mm (inch)

Actuator

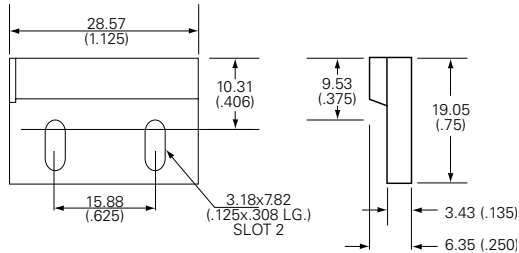

Sensor

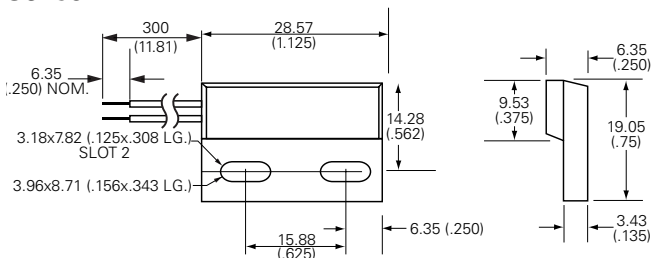

Schematics	Switch Type
	1 and 2
	3
	4

Applications

- Position and limit sensing
- Security system switch
- Linear actuators
- Door switch

59135 High Temperature Flange Mount Sensor + 57135 Actuator

Electrical Ratings

Contact Type			Normally Open	Normally Open High Voltage	Change Over	Normally Closed
Switch Type			1	2	3	4
Contact Rating ¹		VA/Watt - max.	10	10	5	5
Voltage ⁴	Switching ²	Vdc - max.	200	300	175	175
	Breakdown ³	Vac - max.	140	265	120	120
		Vdc - min.	250	400	200	200
Current ⁴	Switching ²	Adc - max.	0.5	0.4	0.25	0.25
	Carry	Aac - max.	0.35	0.30	0.18	0.18
		Adc - max.	1.2	1.4	1.5	1.5
Resistance ⁵	Contact, Initial Insulation	Ω - max.	0.2	0.2	0.2	0.2
		Ω - min.	10 ¹⁰	10 ¹⁰	10 ⁹	10 ⁹
Capacitance	Contact	pF - typ.	0.3	0.2	0.3	0.3
Temperature	Operating	°C	-40 to +150	-20 to +150	-40 to +150	-40 to +150

Product Characteristics

Operate Time ⁶		ms - max.	1.0	1.0	3.0	3.0
Release Time ⁶		ms - max.	1.0	1.0	3.0	3.0
Shock ⁷	11ms ½ sine	G - max.	100	100	50	50
Vibration ⁷	50-2000 Hz	G - max.	30	30	30	30

Notes:

- Contact rating - Product of the switching voltage and current should never exceed the wattage rating. Contact Littelfuse for additional load/life information.
- When switching inductive and/or capacitive loads, the effects of transient voltages and/or currents should be considered. Refer to Application Notes AN108A and AN107 for details.
- Breakdown Voltage - per MIL-STD-202, Method 301.
- Electrical Load Life Expectancy - Contact Littelfuse with voltage, current values along with type of load.
- This resistance value is for 11.81mm wire length. Resistance changes when wire lengthens.
- Operate (including bounce)/Release Time - per EIA/NARM RS-421-A, diode suppressed coil (Coil II).
- Shock and Vibration - per EIA/NARM RS-421-A and MIL-STD-202.
- For custom modifications to the wire length or size, or adding a special connector, please contact Littelfuse.

Sensitivity Options (Using 57135 Actuator)

Select Option	Switch Type	S		T		U		V	
		Pull-In AT Range	Activate Distance-D mm (inch) Average	Pull-In AT Range	Activate Distance-D mm (inch) Average	Pull-In AT Range	Activate Distance-D mm (inch) Average	Pull-In AT Range	Activate Distance-D mm (inch) Average
1	Normally Open	12-18	18.5 (.729)	17-23	17.1 (.673)	22-28	15.8 (.622)	27-33	15.1 (.595)
2	High Voltage	--	--	17-23	17.1 (.673)	22-28	15.8 (.622)	27-33	15.1 (.595)
3	Change Over	15-20	16.7 (.657)	20-25	14.7 (.579)	25-30	13.4 (.528)	--	--
4	Normally Closed	15-20	16.7 (.657)	20-25	14.7 (.579)	25-30	13.4 (.528)	--	--

Note:

- Pull-In AT Range: These AT values are the bare reed switch AT before modification.
- The activation distance is average value on the final sensor assembly

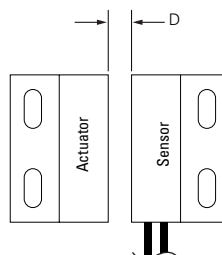



59135 High Temperature Flange Mount Sensor + 57135 Actuator

Cable Length Specification

Cable Type: 20 AWG 19/32 FEP UL1130/UL1332	
Select Option	Cable Length mm (inch)
02	300 (11.81)

Termination Specification

Termination Options		
Select Option	Description (Two-wire versions illustrated)	
A	Tinned leads (6.4±0.76)mm	
F	Untinned leads (6.4±0.76)mm	
E	JST type XHP 2.5mm pitch	

Part Numbering System

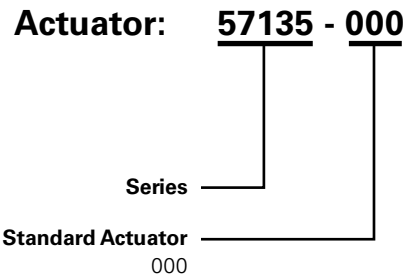
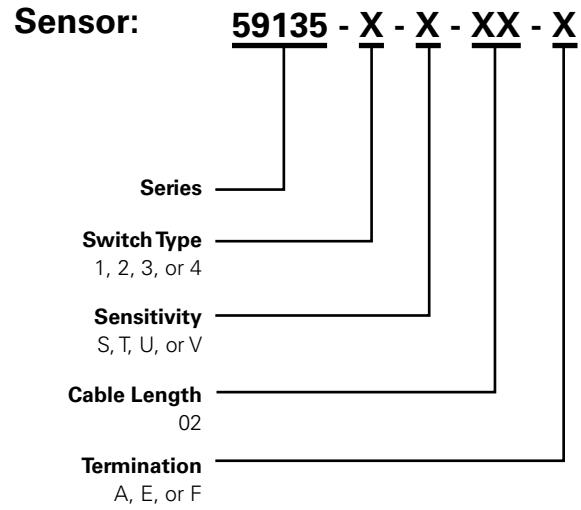

Note: The 57135 Actuator is sold separately.

Packaging

Packaging Option	Packaging Specification	Quantity	Quantity & Packaging Code	Taping Width
Bulk	Bulk	500	N/A	N/A

Disclaimer Notice - Information furnished is believed to be accurate and reliable. However, users should independently evaluate the suitability of and test each product selected for their own applications. Littelfuse products are not designed for, and may not be used in, all applications. Read complete Disclaimer Notice at www.littelfuse.com/disclaimer-electronics.

Looking for pricing, stock, or lifecycle information?

Click below to explore more details on WIN SOURCE:

 [View 59135-2-T-02-A on WIN SOURCE](#)

 [Littelfuse Inc. Information](#)

Optimize Your Supply Chain with WIN SOURCE Solutions

-  Global Sourcing Solution
-  Obsolete Management
-  Cost Control Management
-  Shortage Management
-  Alternative Solution
-  Excess Inventory Management