



**THE DATASHEET OF  
CFM40S090**





# CFM40S SERIES 40WATT OPEN FRAME AC-DC MODULES

## Features

- Universal Input Range 90~264V<sub>ac</sub>
- Efficiency to 87%
- 2"x 4" Size
- Meets Class I
- Approval IEC/EN/UL 62368-1
- Approval EN 55032 Class B and CISPR/FCC Class B
- Operating Altitude 2000m
- Continuous Short Circuit Protection



MODEL NUMBER	OUTPUT VOLTAGE	OUTPUT CURRENT	VOLTAGE ACCURACY NOTE1	RIPPLE & NOISE NOTE2	LINE REGULATION NOTE3	LOAD REGULATION NOTE4	%EFF. (Typ.) NOTE5
CFM40S033	3.3 V	6 A	±1%	50 mV	±0.5%	±1%	70%
CFM40S050	5 V	6 A	±1%	50 mV	±0.5%	±1%	76%
CFM40S090	9 V	4.45 A	±1%	90 mV	±0.5%	±1%	84%
CFM40S120	12 V	3.34 A	±1%	120 mV	±0.5%	±1%	85%
CFM40S150	15 V	2.67 A	±1%	150 mV	±0.5%	±1%	85%
CFM40S240	24 V	1.67 A	±1%	240 mV	±0.5%	±1%	85%
CFM40S300	30 V	1.33 A	±1%	300 mV	±0.5%	±1%	86%
CFM40S360	36 V	1.11 A	±1%	360 mV	±0.5%	±1%	87%
CFM40S480	48 V	0.834 A	±1%	480 mV	±0.5%	±1%	87%

Note:

1. Voltage accuracy is set at 100% full load and 25°C Ta.
2. Add a 0.1uF ceramic capacitor and a 10uF E.L. capacitor to output for ripple & noise measuring @20MHz B.W.
3. Line regulation is measured from high line to low line with 100% full load.
4. Load regulation is measured from 10% to 100% full load.
5. Typical efficiency at 230 V<sub>ac</sub> and 100% full load at 25°C.
6. Safety approvals do not apply to the covered versions, only to the open-frame versions.

## PART NUMBER

Series	Number of Outputs	Nominal Output Voltage	Type
CFM40	S	XXX	-X (Option)
CFM40	S : Single	033 : 3.3V 050 : 05V 090 : 09V 120 : 12V 150 : 15V 240 : 24V 300 : 30V 360 : 36V 480 : 48V	None : Wafer  P : PCB Mount  CA : Cover

Part Number Example:

- CFM40S120:** Open Frame Type, 40W, Single 12Vdc Output
- CFM40S120-P:** PCB Mount Type, 40W, Single 12Vdc Output
- CFM40S120-CA:** Cover Type, 40W, Single 12Vdc Output



# CFM40S Series

## TECHNICAL SPECIFICATIONS

(All specifications are typical at nominal input, 100% full load at 25°C unless otherwise noted.)

### ABSOLUTE MAXIMUM RATINGS

PARAMETER	NOTES and CONDITIONS	Device	Min.	Typ.	Max.	Units
Input Voltage	Safety approvals only to the AC input	All	90		264	$V_{ac}$
				120		370
Operating Temperature	See Derating Curve	All	0		70	°C
Storage Temperature		All	-20		85	°C
Operating Altitude		All			2000	m

### INPUT CHARACTERISTICS

PARAMETER	NOTES and CONDITIONS	Device	Min.	Typ.	Max.	Units
Operating Voltage Range		All	100		240	$V_{ac}$
Input Frequency Range		All	47		63	Hz
Maximum Input Current	100% full load, $V_{in}=100V_{ac}$	All			1.2	A
Leakage Current		All		1		mA
Inrush Current	$V_{in}=240V_{ac}$ , Cold start at 25°C	All			55	A

### OUTPUT CHARACTERISTICS

PARAMETER	NOTES and CONDITIONS	Device	Min.	Typ.	Max.	Units
Output Voltage Set Point	$V_{in}$ =Nominal $V_{in}$ , $I_o=I_o$ max., $T_c=25^\circ\text{C}$	CFM40S033	3.26	3.3	3.33	$V_{dc}$
		CFM40S050	4.95	5.0	5.05	
		CFM40S090	8.91	9.0	9.09	
		CFM40S120	11.88	12.0	12.12	
		CFM40S150	14.85	15.0	15.15	
		CFM40S240	23.76	24.0	24.24	
		CFM40S300	29.70	30.0	30.30	
		CFM40S360	35.64	36.0	36.36	
		CFM40S480	47.52	48.0	48.48	
Operating Output Current Range	$V_{in}=90V_{ac} \sim 264V_{ac}$ , See Derating Curve	CFM40S033			6	A
		CFM40S050			6	
		CFM40S090			4.45	
		CFM40S120			3.34	
		CFM40S150			2.67	
		CFM40S240			1.67	
		CFM40S300			1.33	
		CFM40S360			1.11	
		CFM40S480			0.834	
Holdup Time	$V_{in}=115V_{ac}$	All		8	ms	
Output Voltage Regulation						
Load Regulation	10% load to 100% full load	All			$\pm 1.0$	%
Line Regulation	$V_{in}$ =High line to low line	All			$\pm 0.5$	%
Over Current Protection	Hiccup mode (auto recovery)	All	110		180	%
Short Circuit Protection	Hiccup mode (auto recovery)	All				



# CFM40S Series

PARAMETER	NOTES and CONDITIONS	Device	Min.	Typ.	Max.	Units
Over Voltage Protection	Uses a TVS component to clamp output voltage	CFM40S033		6.8		V <sub>dc</sub>
		CFM40S050		6.8		
		CFM40S090		11		
		CFM40S120		15		
		CFM40S150		18		
		CFM40S240		30		
		CFM40S300		36		
		CFM40S360		47		
		CFM40S480		56		
Output Ripple and Noise	1. Add a 0.1uF ceramic capacitor and a 10uF aluminum electrolytic capacitor to output 2. Oscilloscope is 20MHz bandwidth 3. Ambient temperature=25°C	CFM40S033			50	mV
		CFM40S050			50	
		CFM40S090			90	
		CFM40S120			120	
		CFM40S150			150	
		CFM40S240			240	
		CFM40S300			300	
		CFM40S360			360	
		CFM40S480			480	
Load Capacitance	1. V <sub>in</sub> =115V <sub>ac</sub> and 230V <sub>ac</sub> 2. Output is 100% full load 3. Ambient temperature=25°C	CFM40S033			6000	uF
		CFM40S050			6000	
		CFM40S090			4450	
		CFM40S120			3700	
		CFM40S150			1980	
		CFM40S240			1710	
		CFM40S300			940	
		CFM40S360			1050	
		CFM40S480			850	
Efficiency	1. V <sub>in</sub> =230V <sub>ac</sub> 2. Output is 100% full load 3. Ambient temperature=25°C	CFM40S033		70		%
		CFM40S050		76		
		CFM40S090		84		
		CFM40S120		85		
		CFM40S150		85		
		CFM40S240		85		
		CFM40S300		86		
		CFM40S360		87		
		CFM40S480		87		

## ISOLATION CHARACTERISTICS

PARAMETER	NOTES and CONDITIONS	Device	Min.	Typ.	Max.	Units
Input to Output	1 Minute	All			4242	V <sub>dc</sub>
Isolation Resistance	Input to Output	All	100			MΩ

## FEATURE CHARACTERISTICS

PARAMETER	NOTES and CONDITIONS	Device	Min.	Typ.	Max.	Units
Switching Frequency	P <sub>out</sub> =max. rated power	All		66		kHz



# CFM40S Series

## GENERAL SPECIFICATIONS

PARAMETER	NOTES and CONDITIONS	Device	Min.	Typ.	Max.	Units
MTBF	I <sub>o</sub> =100%; T <sub>a</sub> =25°C per MIL-HDBK-217F I <sub>o</sub> =100%; T <sub>a</sub> =25°C per Telcordia SR332	All	350 5500			k hours
Humidity	Non-condensing	All			93	% RH
Shock	Meet MIL-STD-810F Table 516.5, Table 516.5-I 10ms, each axis 3 times(±X · ±Y · ±Z axis)	All		75		g
Vibration	Meet MIL-STD-810F Table 514.5C-VIII, 15~2000Hz, X · Y · Z axis, 1 hour (each axis), Total 3 hrs.	All		4		g
Weight	Open Frame versions PCB Mount versions Covered versions	All		170 168 230		grams
Dimensions	Open Frame (Wafer)	All	4.000x2.000x1.200 Inches (101.60x50.80x30.48 mm)			
	P (PCB Mount)		4.000x2.000x1.275 Inches (101.60x50.80x32.38 mm)			
	CA (Cover)		4.606x2.480x1.575 Inches (117.00x63.00x40.00 mm)			
<b>Safety</b>	Class I, IEC/EN/UL 62368-1					Ed.3.0
<b>EMC Emission</b>	EN 55032:2015+A11:2020, EN 61000-6-3:2007+A1:2011+AC:2012, Class B, EN 61204-3:2018, EN 61000-3-2:2019, EN 61000-3-3:2013+A1:2019, FCC CFR 47 Part 15					
Conducted Disturbance	EN 55032:2015+A11:2020, EN 61000-6-3:2007+A1:2011+AC:2012, EN 61204-3:2018, FCC CFR 47 Part 15					Class B
Radiated Disturbance	EN 55032:2015+A11:2020, EN 61000-6-3:2007+A1:2011+AC:2012, EN 61204-3:2018, FCC CFR 47 Part 15					Class B
Harmonic Current Emissions	EN 61000-3-2:2019					Class A
Voltage Fluctuations & Flicker	EN 61000-3-3:2013+A1:2019					
<b>EMC Immunity</b>	EN 55035:2017+A11:2020, EN 61000-6-1:2019, EN 61204-3:2018, IEC 61000-4-2, 3, 4, 5, 6, 8, 11					
Electrostatic Discharge (ESD)	IEC 61000-4-2:2008, Air Discharge: ±8kV Contact, Discharge: ±4kV					Criterion A
Radio-Frequency, Continuous Radiated Disturbance	IEC 61000-4-3:2020					Criterion A
Electrical Fast Transient (EFT)	IEC 61000-4-4:2012, ±1kV					Criterion A
Surge	IEC 61000-4-5:2014+A1:2017, L-N: ±0.5kV, ±1kV, L-E(Ground): ±0.5kV, ±1kV, ±2kV					Criterion A
Conducted Disturbances, Induced by RF Fields	IEC 61000-4-6:2013+COR1:2015					Criterion A
Power Frequency Magnetic Field	IEC 61000-4-8:2009					Criterion A
Voltage Dips	IEC 61000-4-11:2020, Dips: 30% Reduction, Dips: >95% Reduction					Criterion A
Voltage Interruptions	IEC 61000-4-11:2020, >95% Reduction					Criterion B
Application Note Link	<a href="#">CFM40S Series App Notes</a>					



## CHARACTERISTIC CURVE

### Power Derating Curve

#### Open Frame versions

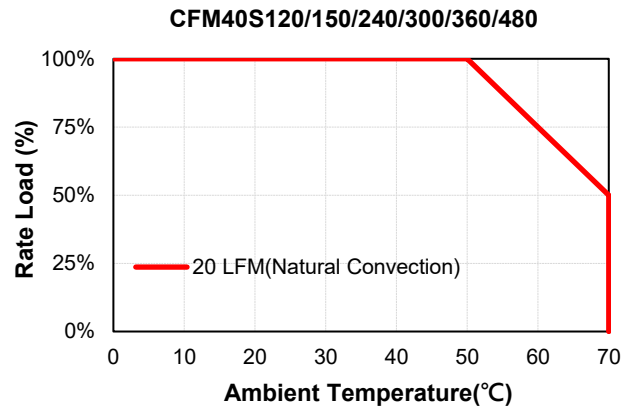
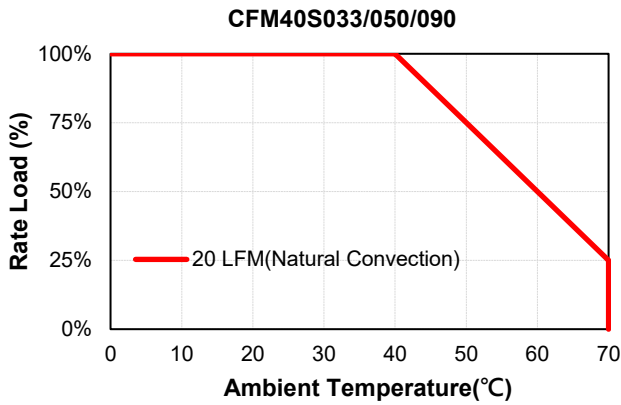

#### Covered versions

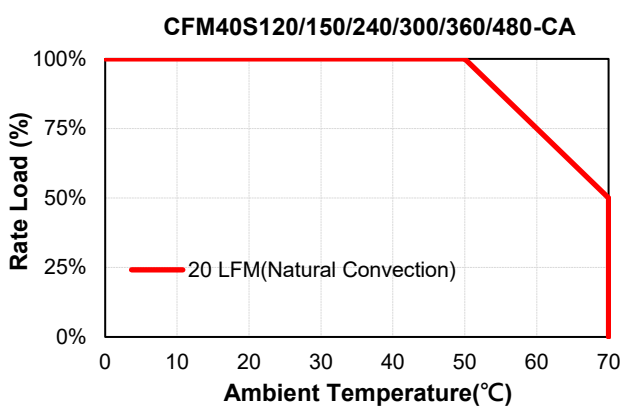
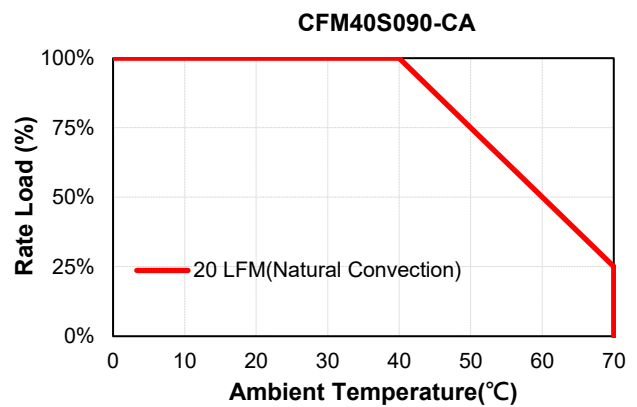
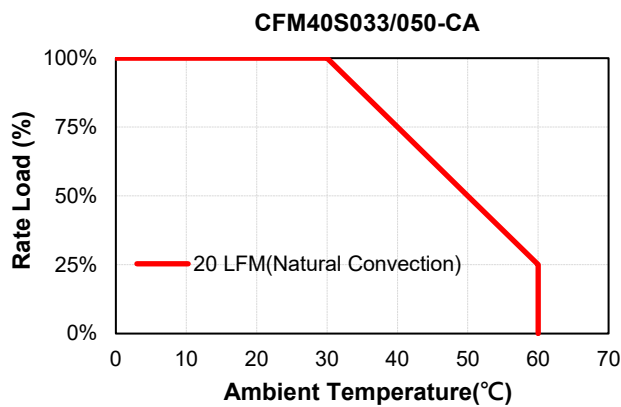



# CFM40S Series

## Performance Data

### CFM40S033 (Eff Vs Io)

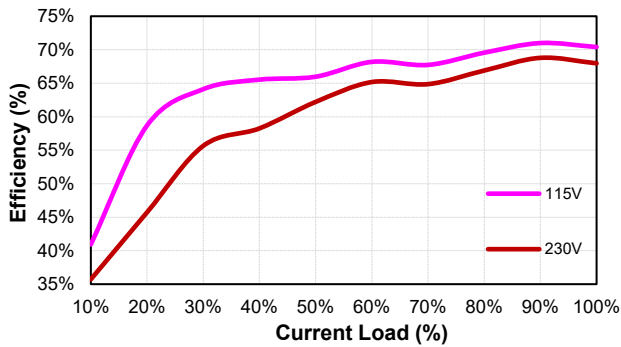

### CFM40S050 (Eff Vs Io)

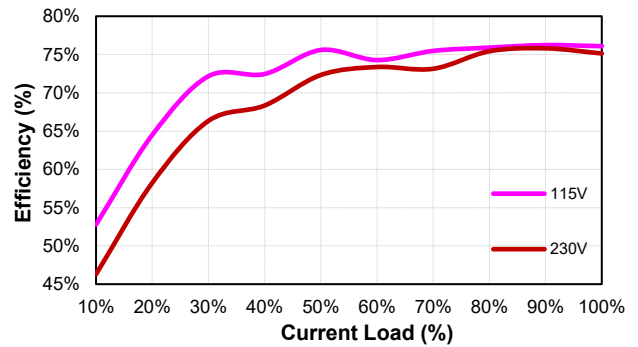

### CFM40S090 (Eff Vs Io)

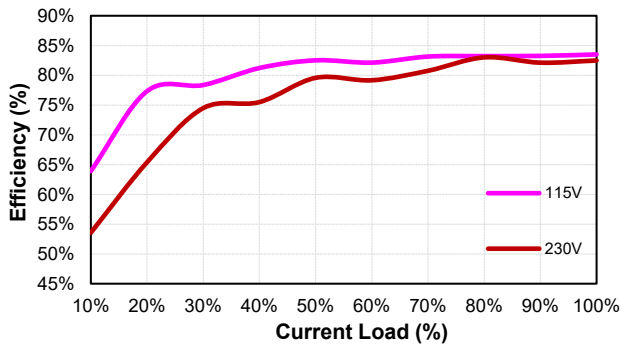

### CFM40S120 (Eff Vs Io)

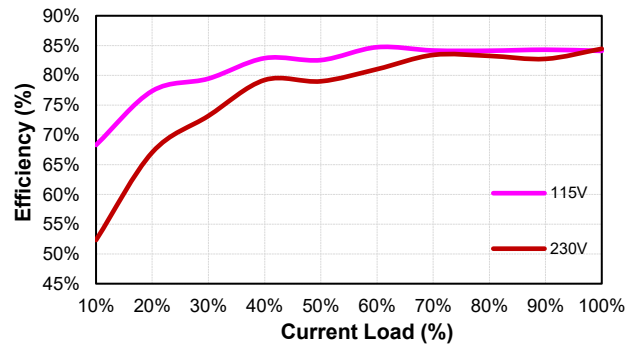

### CFM40S150 (Eff Vs Io)

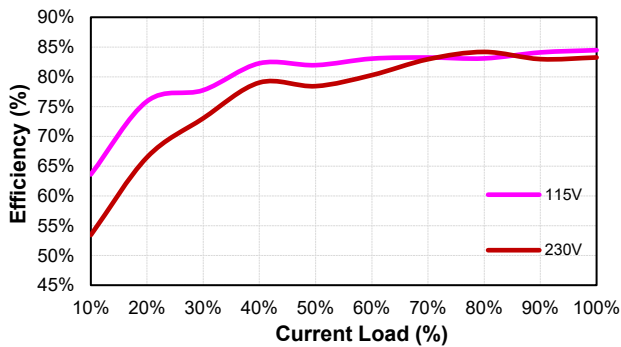

### CFM40S240 (Eff Vs Io)

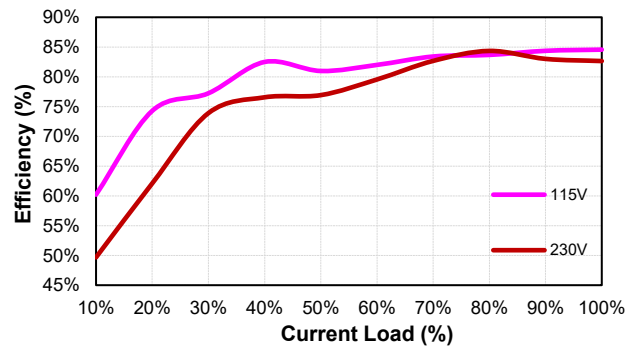

### CFM40S300 (Eff Vs Io)

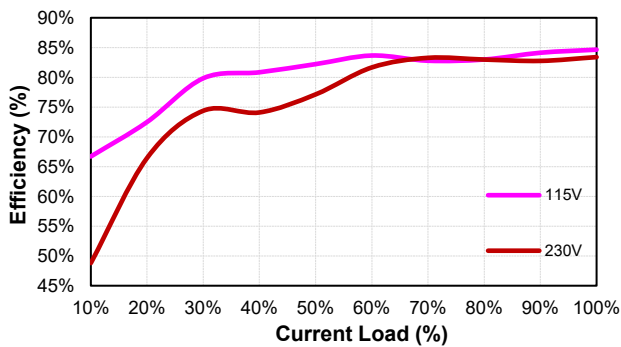

### CFM40S360 (Eff Vs Io)

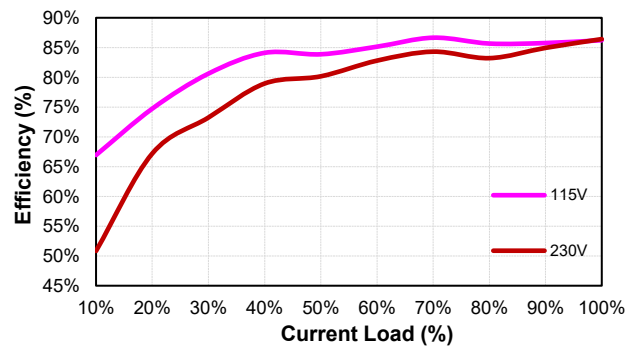



# CFM40S Series

CFM40S480 (Eff Vs Io)

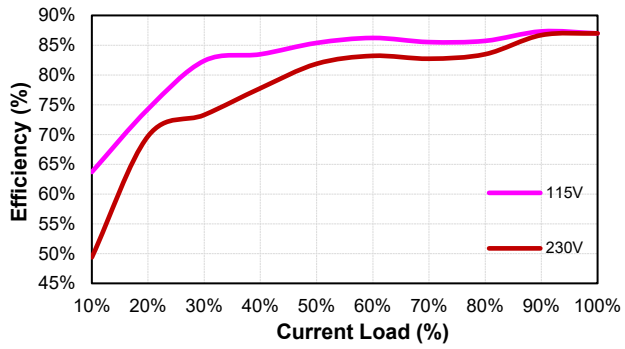



# CFM40S Series

## MECHANICAL SPECIFICATION

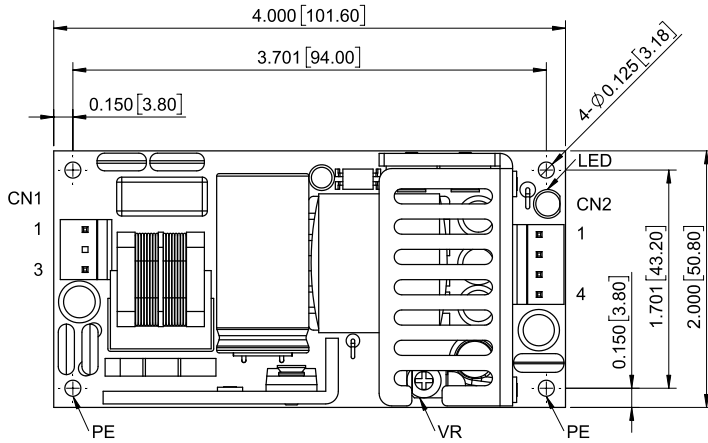

### CFM40SXXX

All Dimensions in Inches[mm]  
Tolerance Inches: x.xxx $\pm$ 0.020  
Millimeters: x.xx $\pm$ 0.50

AC Input Connector(CN1):LCU P3060-03-2-S2 or equivalent

Pin	Function	Mating Housing	Terminal
1	ACN	MOLEX 09501031 or equivalent	MOLEX 08701031 or equivalent
2	-		
3	ACL		

DC Output Connector(CN2):LCU P3060-04-S2 or equivalent

Pin	Function	Mating Housing	Terminal
1	+Vout	MOLEX 09501041 or equivalent	MOLEX 08701031 or equivalent
2	+Vout		
3	-Vout		
4	-Vout		

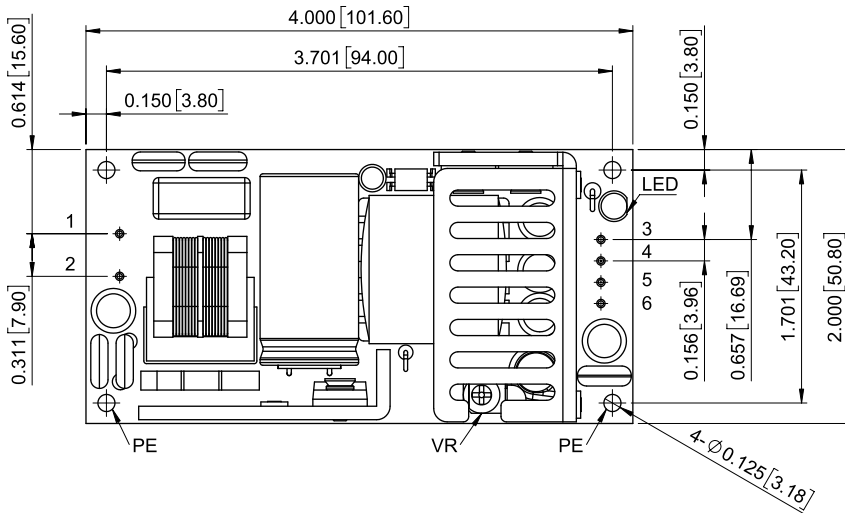
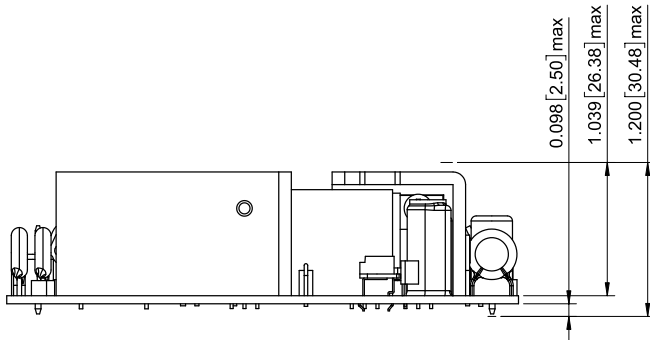

### CFM40SXXX-P

All Dimensions in Inches[mm]  
Tolerance Inches: x.xx $\pm$ 0.02  
Millimeters: x.x $\pm$ 0.5

Pin Connection

Pin	Function
1	ACN
2	ACL
3	+Vout
4	+Vout
5	-Vout
6	-Vout

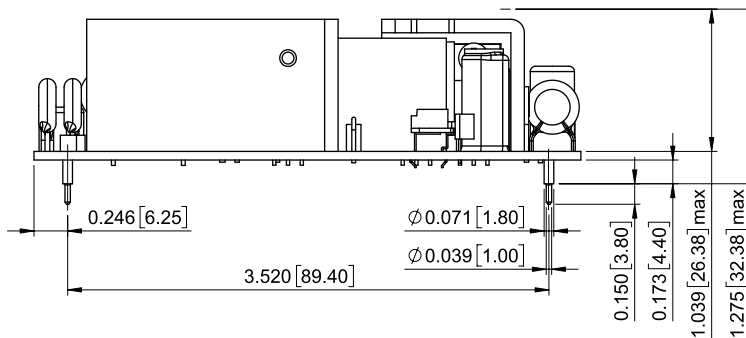



# CFM40S Series

## MECHANICAL SPECIFICATION

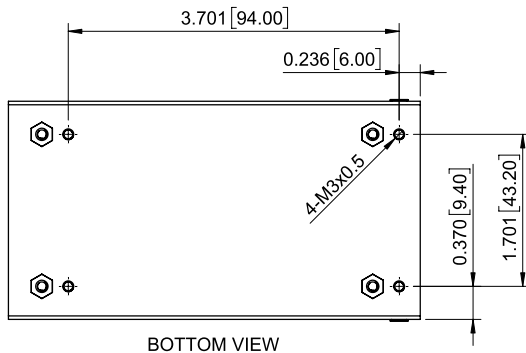
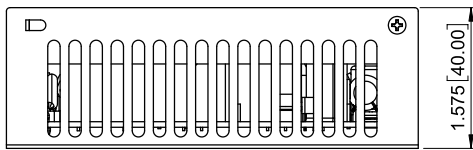
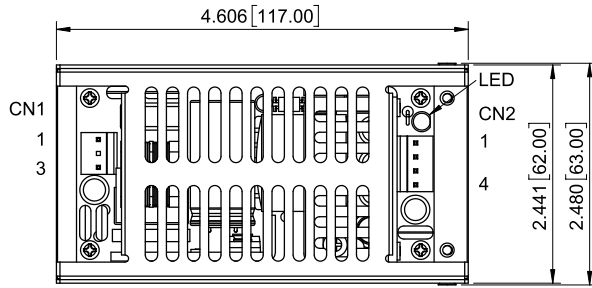

### CFM40SXXX-CA

All Dimensions in Inches[mm]  
 Tolerance Inches: x.xxx=±0.020  
 Millimeters: x.xx=±0.50

AC Input Connector(CN1):LCU P3060-03-2-S2 or equivalent

Pin	Function	Mating Housing	Terminal
1	ACN	MOLEX 09501031 or equivalent	MOLEX 08701031 or equivalent
2	-		
3	ACL		



DC Output Connector(CN2):LCU P3060-04-S2 or equivalent

Pin	Function	Mating Housing	Terminal
1	+Vout	MOLEX 09501041 or equivalent	MOLEX 08701031 or equivalent
2	+Vout		
3	-Vout		
4	-Vout		

CINCON Electronics Co. Ltd.  
 Add: 14F, No. 306, Sec.4, Hsin Yi Rd., Taipei, Taiwan  
 Tel: 886-2-27086210  
 Fax: 886-2-27029852  
 E-mail: [sales@cincon.com](mailto:sales@cincon.com)  
 Web: [www.cincon.com](http://www.cincon.com)

## Looking for pricing, stock, or lifecycle information?

Click below to explore more details on WIN SOURCE:

-  [View CFM40S090 on WIN SOURCE](#)
-  [Cincon Electronics Co. LTD Information](#)

## Optimize Your Supply Chain with WIN SOURCE Solutions

-  Global Sourcing Solution
-  Obsolete Management
-  Cost Control Management
-  Shortage Management
-  Alternative Solution
-  Excess Inventory Management