



**THE DATASHEET OF**  
**4304.6021**



IEC Appliance Inlet C14 with Fuseholder 1- or 2-pole



See below:  
[Approvals and Compliances](#)

**Description**

- Panel mount :  
 Screw-on from front side
- Appliance Inlet , Protection class I
- Fuseholder for fuse-links 5 x 20 mm
- Meets the requirements of IEC 60335-1 for appliances in unattended use. This includes the enhanced requirements of glow wire tests acc. to IEC 60695-2-11 or -12 &-13.
- Solder / Quick Connect

**Characteristics**

- The fuse drawer "Fingergrip" can be removed by hand

**Weblinks**

[pdf data sheet](#), [html datasheet](#), [General Product Information](#), [Approvals](#), [Distributor-Stock-Check](#), [Accessories](#), [Detailed request for product](#)

**Technical Data**

Ratings IEC	10A / 250VAC; 50Hz	Appliance inlet/-outlet	C14 acc. to IEC 60320-1
Ratings UL/CSA	10A / 250VAC; 60Hz		UL 498, CSA C22.2 no. 42 (for cold conditions) pin-temperature 70 °C, 10A, Protection Class I
Dielectric Strength	> 1.5kVAC between L-N > 3kVAC between L/N-PE (1 min/50Hz)	Fuseholder	1-/2-pole, acc. to IEC 60127-6, for fuse-links 5 x 20mm
Allowable Operation Temperature	-25 °C to 70 °C	Rated Power Acceptance @ Ta 23 °C	5 x 20: 2.5W (1 pole)/ 1.6W (2-pole) per pole
IP-Protection	front side IP20 acc. to IEC 60529	Power Acceptance @ Ta > 23°C	Admissible power acceptance at higher ambient temperature see derating curves
Protection against electric shock	Suitable for appliances with protection class I acc. to IEC 61140		
Terminal	Solder / Quick Connect		
Material: Housing	PA6, black / grey / white, UL 94V-0		

**Approvals and Compliances**

Detailed information on product approvals, code requirements, usage instructions and detailed test conditions can be looked up in [Details about Approvals](#)

SCHURTER products are designed for use in industrial environments. They have approvals from independent testing bodies according to national and international standards. Products with specific characteristics and requirements such as required in the automotive sector according to IATF 16949, medical technology according to ISO 13485 or in the aerospace industry can be offered exclusively with customer-specific, individual agreements by SCHURTER.

**Approvals**





The approval mark is used by the testing authorities to certify compliance with the safety requirements placed on electronic products.

Approval Reference Type: 1062

Approval Logo	Certificates	Certification Body	Description
	<a href="#">SEMKO Approvals</a>	SEMKO	Certificate Number: SE/09137-1A
	<a href="#">UL Approvals</a>	UL	UR File Number: E93617
	<a href="#">CCC Approvals</a>	CCC	CCC Certificate Number: 2020180204016732



## Product standards

Product standards that are referenced

Organization	Design	Standard	Description
	Designed according to	IEC 60320-1	Appliance couplers for household and similar general purposes
	Designed according to	IEC 60127-6	Miniature fuses. Part 6. Fuse-holders for miniature fuse-links
	Designed according to	IEC 61058-1	Switches for appliances. Part 1. General requirements
	Designed according to	UL 498	Standard for Attachment Plugs and Receptacles
	Designed according to	CSA C22.2 no. 42	General Use Receptacles, Attachment Plugs, and Similar Wiring Devices







## Application standards

Application standards where the product can be used

Organization	Design	Standard	Description
	Suitable for applications acc.	IEC/UL 62368-1	Audio/video, information and communication technology equipment - Part 1: Safety requirements
	Suitable for applications acc.	IEC 60335-1	Safety of electrical appliances for household and similar purposes. Meets the requirements for appliances in unattended use. This includes the enhanced requirements of glow wire tests acc. to IEC 60695-2-11 or -12 & -13.

## Compliances

The product complies with following Guide Lines

Identification	Details	Initiator	Description
	<a href="#">CE declaration of conformity</a>	SCHURTER AG	The CE marking declares that the product complies with the applicable requirements laid down in the harmonisation of Community legislation on its affixing in accordance with EU Regulation 765/2008.
	<a href="#">UKCA declaration of conformity</a>	SCHURTER AG	The UKCA marking declares that the product complies with the applicable requirements laid down in the British Amendment of Regulation (EC) 765/2008.
	RoHS	SCHURTER AG	Directive RoHS 2011/65/EU, Amendment (EU) 2015/863
	China RoHS	SCHURTER AG	The law SJ / T 11363-2006 (China RoHS) has been in force since 1 March 2007. It is similar to the EU directive RoHS.
	REACH	SCHURTER AG	On 1 June 2007, Regulation (EC) No 1907/2006 on the Registration, Evaluation, Authorization and Restriction of Chemicals 1 (abbreviated as "REACH") entered into force.
	White Paper Glow wire test	SCHURTER AG	Meets the requirements of IEC 60335-1 for appliances in unattended use. This includes the enhanced requirements of glow wire tests acc. to IEC 60695-2-11 or -12 & -13.

Dimensions [mm]

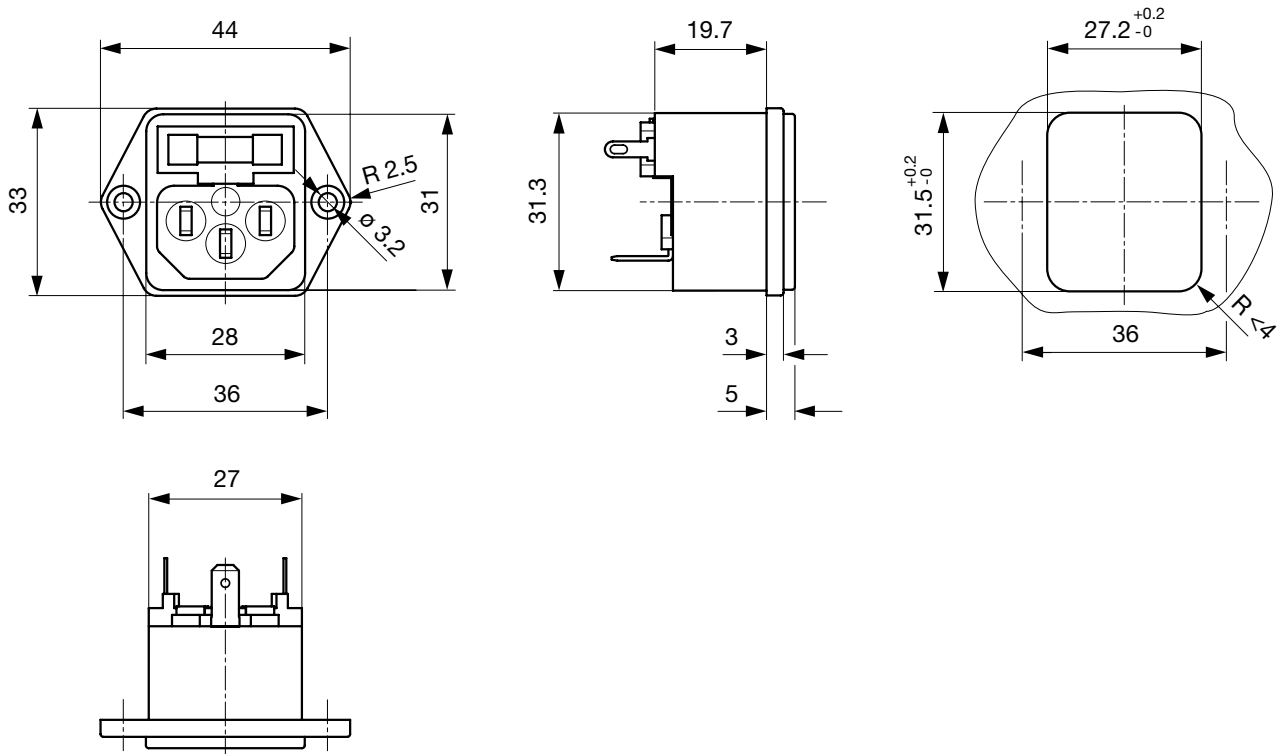

Length of the terminal please find at the order code configuration table

Derating Curves

Fuses  
 5 x 20 mm (1-pole)

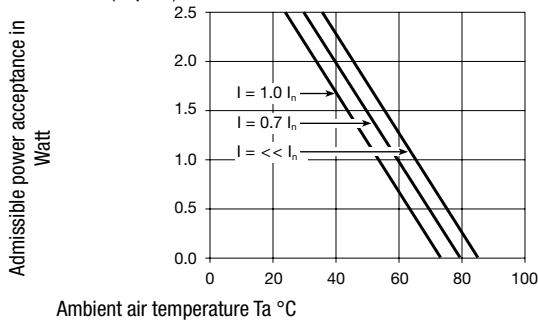

2-pole

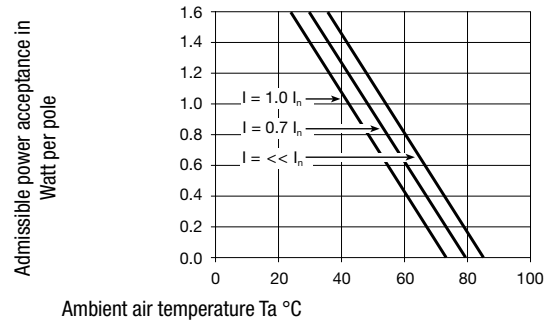

Config. Code

1062 - H - ABCN - D - EGO

The characters are placeholders for the correspondingly keys of selections from the key tables.

1062 - H - ABCN - D - EGO = Type

Type	Configuration key
protection class I	X

1062 - H - A ABCN - D - EGO = Terminals

Terminal L	Configuration key
connection to fuse holder	B

1062 - H - A B CN - D - EGO = Terminals

Terminal N	Configuration key
short solder terminal (L = 4.8 mm)	2
long solder terminal (L = 8.5 mm)	3
Blade terminal (4.8 x 0.8 mm)	8
Blade terminal (6.3 x 0.8 mm)	9
connection to fuse holder	B

Symbols similar as in table A

1062 - H - AB C N - D - EGO = Terminals

Terminal Ground	Configuration key
without terminal	0
short solder terminal (L = 4.8 mm)	2
long solder terminal (L = 8.5 mm)	3
Blade terminal (4.8 x 0.8 mm)	8
Blade terminal (6.3 x 0.8 mm)	9

Symbols similar as in table A

### 1062 - H - A B C N - D - E G O = Terminal Fuseholder

Terminal Fuseholder	Configuration key
solder terminal	1

### 1062 - H - A B C N - D - E G O = Color

Color	Configuration key
Black	A
Grey	B
White	D

### 1062 - H - A B C N - D - E G O = Style

Style	Configuration key
flange with countersunk holes	1
flange with through holes	2

### 1062 - H - A B C N - D - E G O = Dimension S

Dimension "S"	Configuration key
00	

The dimension "S" is displayed in (1/10 mm). This information is also valid for the order code

### 1062 - H - A B C N - D - E G O = Features

Features	Configuration key
dead cover	1
holder for 1 or 2 fuses (text legible, when inlet on top)	4
holder for 1 or 2 fuses (text legible, when inlet on bottom)	5

## Variants

Connector						Fuseholder		Config. Code	Order Number
Type	Terminal L	Terminal N	Terminal Ground	Color	Style	Marking	Number of Poles		
protection class I	connection to fuse holder	Blade terminal (4.8 x 0.8 mm)	Blade terminal (4.8 x 0.8 mm)	Black	flange with countersunk holes	holder for 1 or 2 fuses (text legible, when inlet on top)	1-pole	1062-X-B881-A-1004	4304.6013
protection class I	connection to fuse holder	Blade terminal (6.3 x 0.8 mm)	Blade terminal (6.3 x 0.8 mm)	Black	flange with countersunk holes	holder for 1 or 2 fuses (text legible, when inlet on top)	1-pole	1062-X-B991-A-1004	4304.6014
protection class I	connection to fuse holder	connection to fuse holder	short solder terminal (L = 4.8 mm)	Black	flange with countersunk holes	holder for 1 or 2 fuses (text legible, when inlet on top)	2-pole	1062-X-BB21-A-1004	4304.6015
protection class I	connection to fuse holder	connection to fuse holder	Blade terminal (4.8 x 0.8 mm)	Black	flange with countersunk holes	holder for 1 or 2 fuses (text legible, when inlet on top)	2-pole	1062-X-BB81-A-1004	4304.6019
protection class I	connection to fuse holder	connection to fuse holder	Blade terminal (6.3 x 0.8 mm)	Black	flange with countersunk holes	holder for 1 or 2 fuses (text legible, when inlet on top)	2-pole	1062-X-BB91-A-1004	4304.6020

The listed variants should be available from stock. Other versions on request [www.schurter.com/contact](http://www.schurter.com/contact)

Availability for all products can be searched real-time: <https://www.schurter.com/en/info-center/support-tools/stock-check-distributors>

## Packaging unit

50 Pcs

## Accessories

### Description



**RC320**  
Rear Cover for Power Entry Module

**Mating Outlets/Connectors**

**Category / Description**

[Appliance Outlet Overview complete](#)



4787, Mounting: Screw-on mounting, Appliance Outlet: IEC Solder terminals, 10 A, Suitable for appliances with protection class I	4787
4788, Mounting: Snap-in version, Appliance Outlet: IEC Solder / Quick Connect, 10 A, Suitable for appliances with protection class I	4788
IEC Appliance Outlet F or H, Screw-on Mounting, Front Side, Solder, PCB or Quick-connect Terminal	5091

[Connector Overview complete](#)



4782 Mounting: Power Cord, 3 x 1 mm <sup>2</sup> / 3 x 18 AWG, Cable, Connector: IEC C13	4782
4785 Mounting: Power Cord, 3 x 1 mm <sup>2</sup> / 3 x 18 AWG, Cable, Connector: IEC C13	4785
4300-06 Mounting: Power Cord, 3 x 1 mm <sup>2</sup> / 3 x 18 AWG, Cable, Connector: IEC C13	4300-06
4781 Mounting: Power Cord, Cable, Connector: IEC C15	4781
4784 Mounting: Power Cord, 3 x 1 mm <sup>2</sup> / 3 x 18 AWG, Cable, Connector: IEC C15	4784

[Interconnection Cord Overview complete](#)



Cord Sets 10 A, Interconnection, 2.0 m, IEC H05VV-F3G1.0, black	6007.0204
Cord Sets 10 A, Interconnection, 1.0 m, Connector IEC C13, H05VV-F3G1.0, black	6007.0212
Cord Sets 10 A, Interconnection, 2.0 m, Connector IEC C13, H05VV-F3G1.0, black	6007.0214

[Power Supply Cord Overview complete](#)



Cord Sets 10 A, Europlug, 2.5 m, Connector IEC C13, H05VV-F3G1.0, black	6004.0215
Cord Sets 10 A, Europlug, 2.5 m, Connector IEC C13, H05VV-F3G1.0, black	6003.0215
Cord Sets 10 A, uninsulated wires, 2.0 m, Connector IEC C13, H05VV-F3G1.0, black	6000.0224
Cord Sets 10 A, uninsulated wires, 2.0 m, Connector IEC C13, H05VV-F3G1.0, black	6000.0214
Cord Sets 10 A, United Kingdom, 2.5 m, Connector IEC C13, H05VV-F3G1.0, black	6044.0215

...

[Power Supply or Interconnection Cord Overview complete](#)



Cord Sets 10 A, United Kingdom, 2.0 m, Connector IEC H05VV-F3G1.0, black	6044.0204
--	-----------

**Mating Outlets/Connectors shuttered**



[Power Cord Overview complete](#)

VAC17KS, V-Lock cord retaining, diverse m, Connector IEC C17, diverse, black / grey / white	VAC17KS
---	---------

## Looking for pricing, stock, or lifecycle information?

Click below to explore more details on WIN SOURCE:

 [View 4304.6021 on WIN SOURCE](#)

 [Schurter Inc. Information](#)

## Optimize Your Supply Chain with WIN SOURCE Solutions

-  Global Sourcing Solution
-  Obsolete Management
-  Cost Control Management
-  Shortage Management
-  Alternative Solution
-  Excess Inventory Management