



**THE DATASHEET OF  
RLP3-600-500**



REV.	DESCRIPTION	DATE	APPROVED
	PART DESCRIPTION		
	Surface Mount Right Angle Light Pipe, 2.8mm, 3 Station.		
	See Table on 2nd Page		
	LPR Housing, 3 Station, White. See Table on 2nd Page		

REV.	DESCRIPTION	DATE	APPROVED
<b>A</b>	Engineering Release	11/06/09	T. Y.
<b>B</b>	Added Overall Height "K" Dim	03/04/11	T. Y.
<b>C</b>	Added Overall Snap Height Dimension	08/15/12	T. Y.
<b>D</b>	Added Color Options, Sheet #3	02/02/16	J. C.
<b>E</b>	ECO-1066: Updated Mounting Hole Dimensions	08/11/20	A. V.

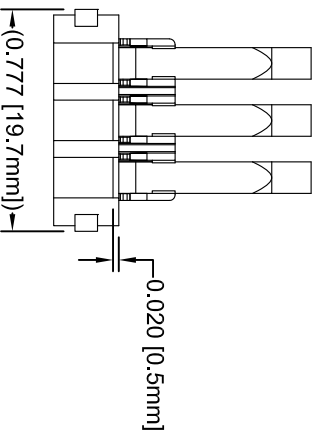
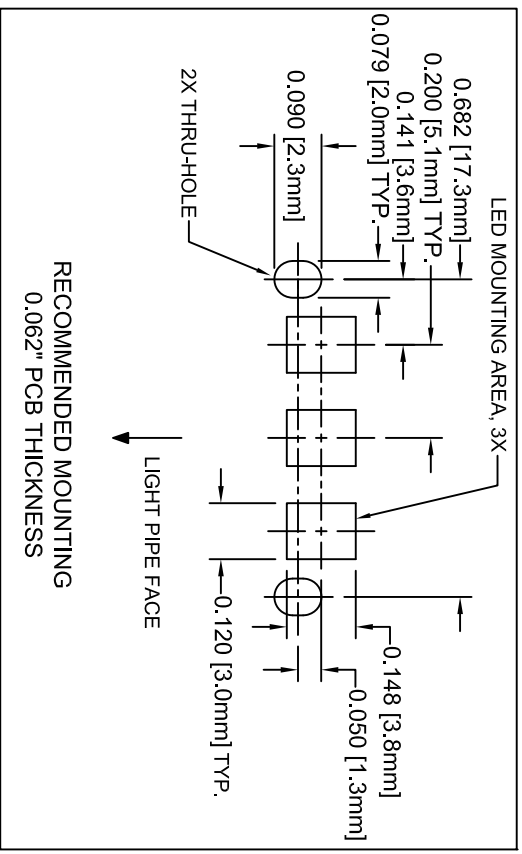
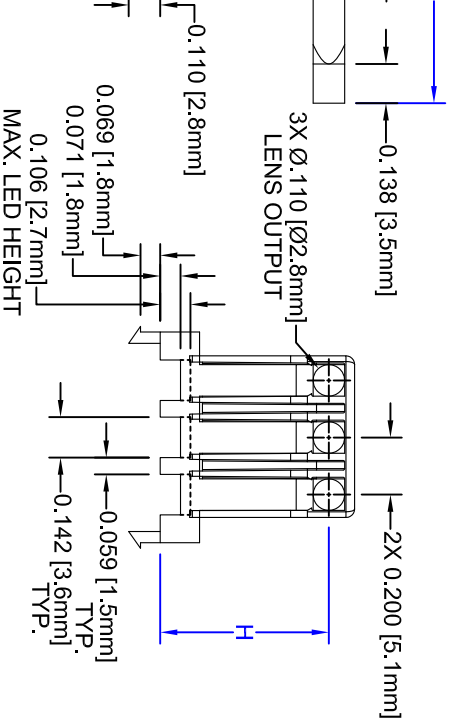
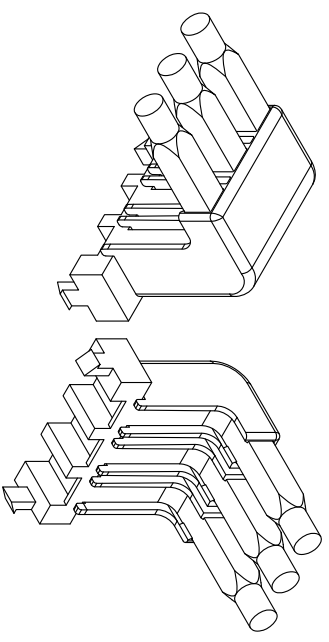
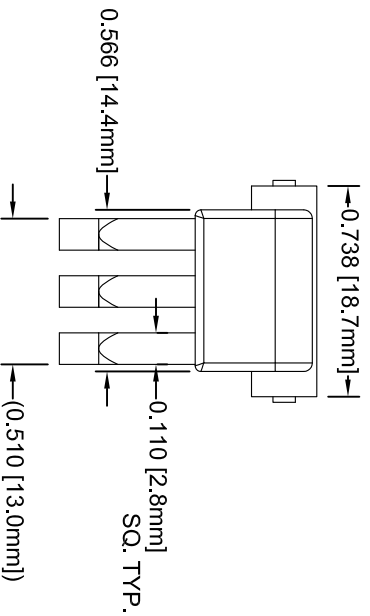

STANDARD TOLERANCE  
(UNLESS OTHERWISE SPECIFIED)

DECIMALS  
.X ± .1  
.XX ± .01  
.XXX ± .010

ANGULAR  
X° ± 1°

**BIVAR**

4 THOMAS, IRVINE, CA, 92618  
TEL: (949) 951-8808 FAX: (949) 951-3874



TITLE: RIGHT ANGLE LIGHT PIPE,  
2.8MM, 3 STATION

DESIGNED:	<b>R. Paje</b>	DATE:	11/06/09	PART NO.:	RLP3-XXX-XXX	REVISION:	<b>E</b>
REVISED:	<b>K. Baron</b>	DATE:	08/11/20	SHEET SIZE:	<b>A</b>	CAGE CODE:	32559
CHECKED:	<b>A. Valdez</b>	DATE:	08/11/20	SCALE:	1:1	SHEET #	1 OF 3

CAD GENERATED DOCUMENT, DO NOT MEASURE DRAWING

REV.	DESCRIPTION	DATE	APPROVED
SEE SHEET #1			

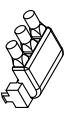
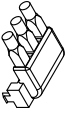
**RLP3-XXX-XXX**

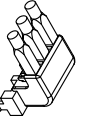
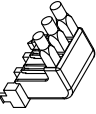
N	H	L	K			FIGURE
500	0.197 [5.0mm]	0.551 [14.0mm]	0.287 [7.3mm]	LPR3-XXX-XXX	RLPH3-XXX	
		0.669 [17.0mm]		LPR3-200-500	RLPH3-200	
300	0.197 [5.0mm]	0.787 [20.0mm]	0.287 [7.3mm]	LPR3-200-800	RLPH3-200	
		0.551 [14.0mm]		LPR3-400-500	RLPH3-400	
500	0.394 [10.0mm]	0.669 [17.0mm]	0.484 [12.3mm]	LPR3-400-650	RLPH3-400	
		0.787 [20.0mm]		LPR3-400-800	RPH3-400	
500	0.591 [15.0mm]	0.551 [14.0mm]	0.681 [17.3mm]	LPR3-600-500	RLPH3-600	
		0.669 [17.0mm]		LPR3-600-650	RLPH3-600	
300	0.591 [15.0mm]	0.787 [20.0mm]	0.681 [17.3mm]	LPR3-600-800	RLPH3-600	
		0.669 [17.0mm]				

CAGE CODE:	32559
SHEET SIZE:	A

PART NO:	RLP3-XXX-XXX	REVISION:	E
SCALE:	1:1	SHEET #	2 OF 3
CAD GENERATED DOCUMENT. DO NOT MEASURE DRAWING.			



RRS  
 INFORMATION

REV.	DESCRIPTION	DATE	APPROVED
	SEE SHEET #1		

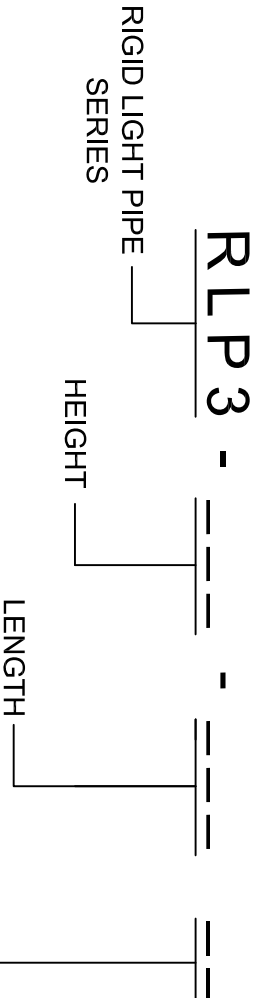

COLOR	Order Code
BLUE	BE
BLACK	BK
GREEN	GN
GRAY	GY
RED	RD
YELLOW	YW

NOTE: LEAVE ORDER CODE BLANK  
 IF NO COLOR IS DESIRED.



EMBLIES WILL BE DYED.  
 OR UPON REQUEST.

CAGE CODE:	32559
SHEET SIZE:	A

		PART NO.:	RLP3-XXX-XXX	REVISION:	E
		SCALE:	1:1	SHEET #	3 OF 3
CAD GENERATED DOCUMENT. DO NOT MEASURE DRAWING.					

## Looking for pricing, stock, or lifecycle information?

Click below to explore more details on WIN SOURCE:

-  [View RLP3-600-500 on WIN SOURCE](#)
-  [Bivar Inc. Information](#)

## Optimize Your Supply Chain with WIN SOURCE Solutions

-  Global Sourcing Solution
-  Obsolete Management
-  Cost Control Management
-  Shortage Management
-  Alternative Solution
-  Excess Inventory Management