



**THE DATASHEET OF
LPV3-0550D-R480**



NOTES:

1. PARTS ARE SHIPPED NON-ASSEMBLED.
2. SEE SHEET 4 FOR PACKAGING PLAN.

REV.	DESCR
B	Engineering Release
C	ECO-1250 - Updated Com
D	ECO-1279 - Updated MFG

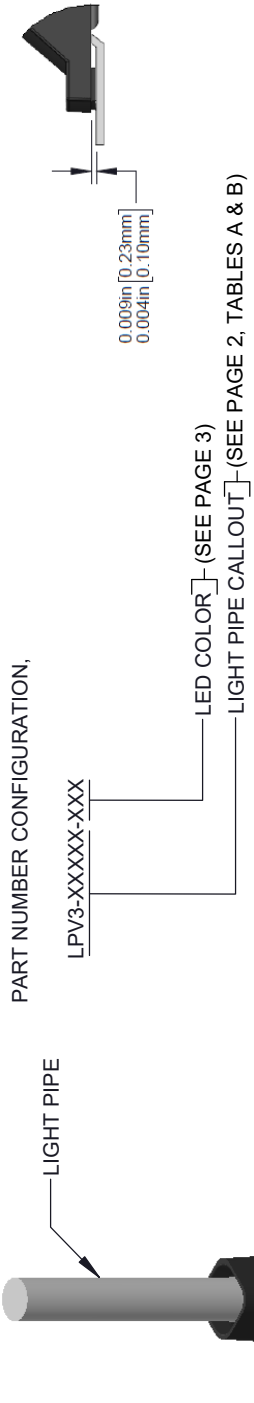

PART NUMBER CONFIGURATION,
 LPV3-XXXXXX-XXX
 LED COLOR (SEE PAGE 3)
 LIGHT PIPE CALLOUT (SEE PAGE 2, TABLES A & B)

(ϕ 0.115in [2.9mm] REF.)

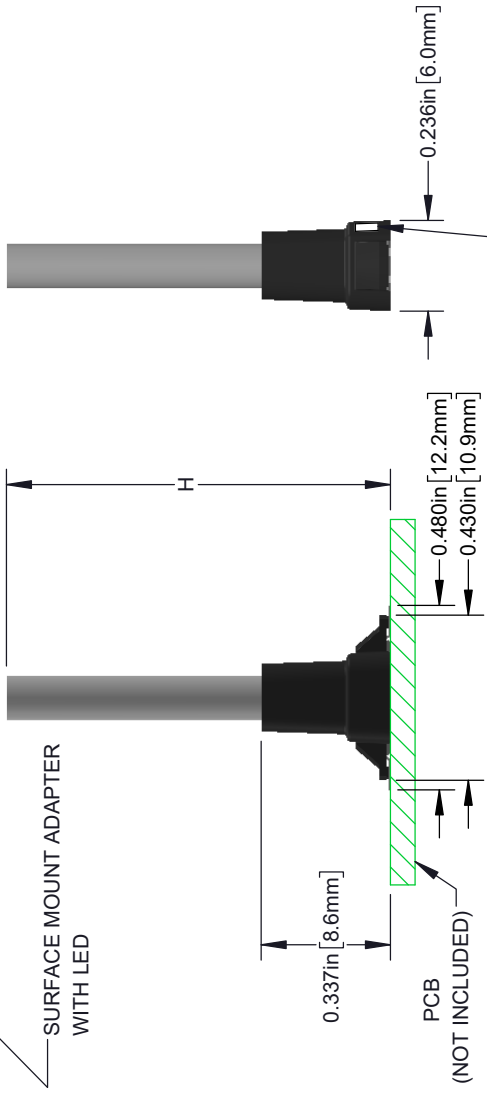

FLAT FACE LENS

DIMENSIONS ARE APPLICABLE TO BOTH LENS FACES UNLESS OTHERWISE NOTED

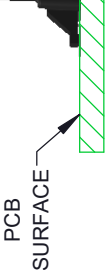
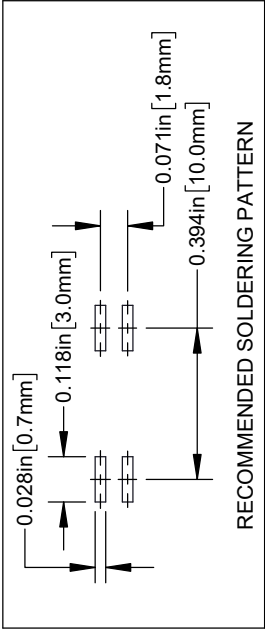

DOME FACE LENS

CUSTOMER

STANDARD TOLERANCE (UNLESS OTHERWISE SPECIFIED)		ANGULAR	DATE:
DECIMALS	X° ± 1°	ϕ	
.X ± .1			DESIGNED: K. BARON 7/11/201
.XX ± .02			REVISD: K. BARON 8/2/2024
.XXX ± .010			CHECKD: D. ASHBY 8/2/2024

REV.

DESCR

See Sheet 1

STANDARD ORDERING INFORMATION

TABLE A - FLAT FACE LENS	
PART NO.	H ± .01
LPV3-0350F-XXX	0.350 [8.9mm]
LPV3-0400F-XXX	0.400 [10.2mm]
LPV3-0450F-XXX	0.450 [11.4mm]
LPV3-0500F-XXX	0.500 [12.7mm]
LPV3-0550F-XXX	0.550 [14.0mm]
LPV3-0600F-XXX	0.600 [15.2mm]
LPV3-0750F-XXX	0.750 [19.1mm]
LPV3-1000F-XXX	1.000 [25.4mm]
LPV3-1250F-XXX	1.250 [31.8mm]
LPV3-1500F-XXX	1.500 [38.1mm]
LPV3-1750F-XXX	1.750 [44.5mm]
LPV3-2000F-XXX	2.000 [50.8mm]

TABLE B - DOME FACE LENS	
PART NO.	H ± .01
LPV3-0350D-XXX	0.350 [8.9mm]
LPV3-0400D-XXX	0.400 [10.2mm]
LPV3-0450D-XXX	0.450 [11.4mm]
LPV3-0500D-XXX	0.500 [12.7mm]
LPV3-0550D-XXX	0.550 [14.0mm]
LPV3-0600D-XXX	0.600 [15.2mm]
LPV3-0750D-XXX	0.750 [19.1mm]
LPV3-1000D-XXX	1.000 [25.4mm]
LPV3-1250D-XXX	1.250 [31.8mm]
LPV3-1500D-XXX	1.500 [38.1mm]
LPV3-1750D-XXX	1.750 [44.5mm]
LPV3-2000D-XXX	2.000 [50.8mm]

CUSTOM!

CAGE CODE: 32555	
SHEET SIZE: A	

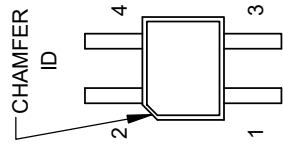
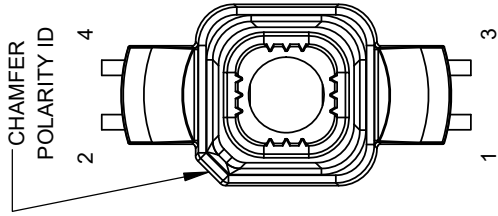

Order Code XXX	Emitted Color	Peak Wave L. λ_p [nm] Chroma TYP	Electro-Optical Data @20mA, 25°C				Polarity Diagram
			V_f [V]		I_v [mcd]		
			MIN	TYP	MAX	TYP	
R130	Red	640	1.7	2.0	2.5	130	FIGURE A
R480	Red	630	1.7	2.0	2.5	480	FIGURE B
A220	Amber	610	1.7	2.0	2.5	220	
O170	Orange	590	1.7	2.0	2.5	170	
Y50	Yellow	570	1.7	2.0	2.5	50	FIGURE C
G850	Green	520	2.8	3.2	3.7	850	
B150	Blue	465	2.8	3.2	3.7	150	
W305	White	X = 0.308 Y = 0.305	2.8	3.0	3.7	1750	FIGURE D
OY	Orange	590	1.7	2.0	2.5	190	
RY	Yellow	572	1.7	2.0	2.5	60	
RG	Red	640	1.7	2.0	2.5	110	FIGURE E
	Yellow	572	1.7	2.0	2.5	55	
	Red	640	1.7	2.0	2.5	200	
RW	Green	520	2.8	3.2	3.7	810	FIGURE F
	Red	630	1.7	2.0	2.5	130	
	White	X = 0.28 Y = 0.29	2.8	3.2	3.7	520	
RB	Red	650	1.7	2.0	2.5	80	FIGURE G
	Blue	465	2.8	3.2	3.7	150	
	Red	643	1.7	2.0	2.5	95	
RGB	Green	515	2.8	3.3	3.7	730	FIGURE H
	Blue	460	2.8	3.3	3.7	120	

Note: 10% Duty Cycle, Pulse Width \leq 0.1msec for Peak If.

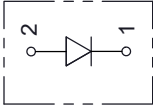

FIG. A

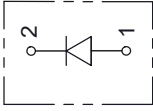

FIG. B

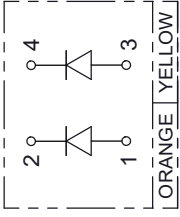

FIG. C

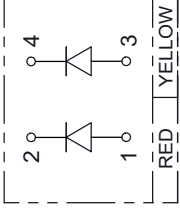

FIG. D

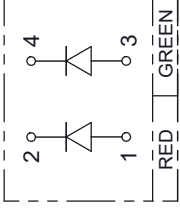

FIG. E

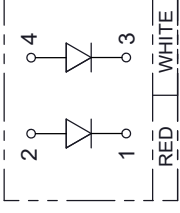

FIG. F

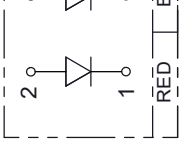

FIG. G

CAGE CODE:	3255
SHEET SIZE:	A

CUSTOMER USE DRAWING

PACKAGING PLAN

PARTS ARE SHIPPED IN QUANTITY OF 400 AS IN THE FOLLOWING:

1. ONE BAG CONTAINING FOUR LIGHT PIPE PACKAGES, 100 EACH, AND ONE LEVEL 4 MOISTURE SEALED TRAY WITH 400 SURFACE MOUNT ADAPTERS.
2. BAG SIZE IS APPROXIMATELY 16 X 18 INCHES (406.4 X 457.2 mm).
3. TRAY SIZE IS APPROXIMATELY 10 X 14 X 0.6 INCHES (254 X 355.6 X 15.2 mm), INCLUDING TOP COVER AND BOTTOM TRAY. ADAPTERS ARE ARRANGED AS SHOWN IN FIGURE 1.

10 ADAPTERS IN EACH POCKET

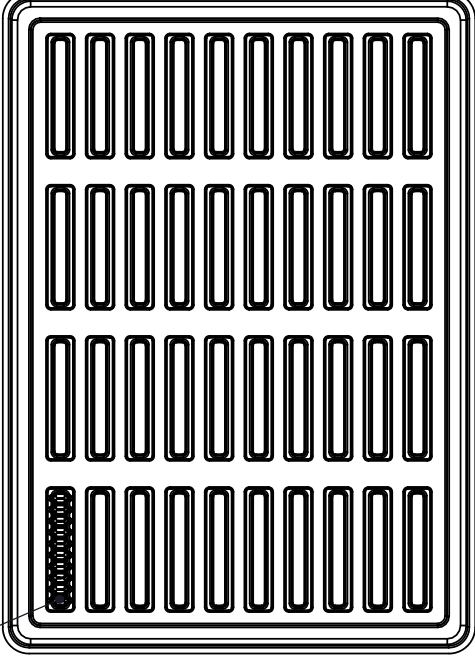
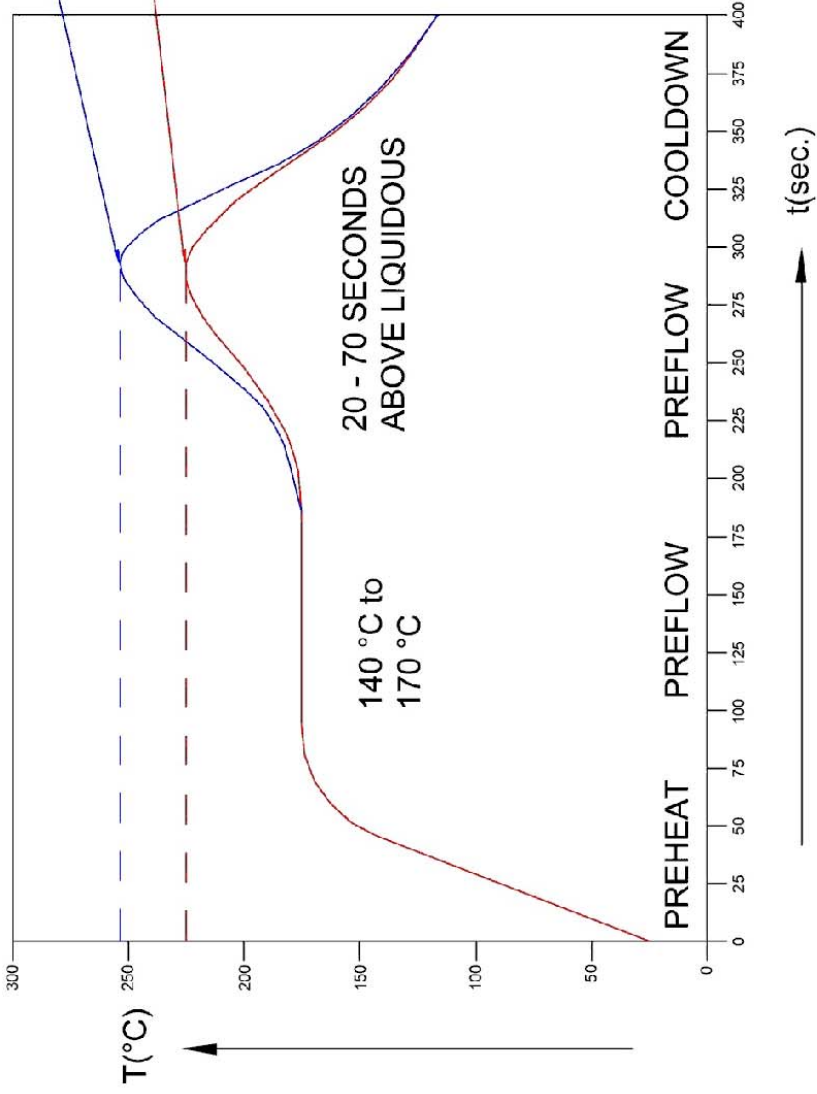

FIGURE 1
BOTTOM TRAY
4 X 10 POCKETS

CUSTOM!

CAGE CODE:	3255
SHEET SIZE:	A

RECOMMENDED REFLOW SOLDERING PROFILE



NOTE:
1. DO NOT CLEAN AFTER SOLDERING. ONLY USE NO-CLEAN SOLDER PASTE.

CUSTOM!

CAGE CODE:	32555
SHEET SIZE:	A

Looking for pricing, stock, or lifecycle information?

Click below to explore more details on WIN SOURCE:

 [View LPV3-0550D-R480 on WIN SOURCE](#)

 [Bivar Inc. Information](#)

Optimize Your Supply Chain with WIN SOURCE Solutions

-  Global Sourcing Solution
-  Obsolete Management
-  Cost Control Management
-  Shortage Management
-  Alternative Solution
-  Excess Inventory Management