

# ILC7071

## 100mA SOT-23-5 Low Noise CMOS RF-LDO™ Regulator

### Features

- 1% output voltage accuracy
- Low noise
- Only 90µA ground current at 100mA load
- Ripple rejection up to 75 dB at 1kHz
- Excellent line and load transient response
- Guaranteed to 100mA output current
- Industry standard five lead SOT-23 packages
- Fixed 2.5V, 2.6V, 2.7V, 2.8V, 2.85V, 2.9V, 3.0V, 3.1V, 3.3V and custom output voltage options

### Applications

- Cellular phones
- Wireless communicators
- PDAs/palmtops/organizers
- Battery powered portable electronics

### General Description

The ILC7071 is an 100mA, Low Noise, Low Dropout (LDO) linear regulator, designed and processed in CMOS technology. This process combines the best CMOS features of low quiescent current, small size and low dropout voltage with the best bipolar features of high ripple rejection, low noise and power handling capability. The ILC7071 offers a quiescent current of less than 100µA, a logic level enable (regulator EN) pin, the size of the industry standard SOT-23 and a low dropout voltage of 25mV at 10mA. With better than 70 dB (1kHz) of ripple rejection, low noise of 40µV<sub>RMS</sub> and 1% output voltage accuracy, the ILC7071 is ideally suited for communications and personal electronics applications.

### Block Diagram

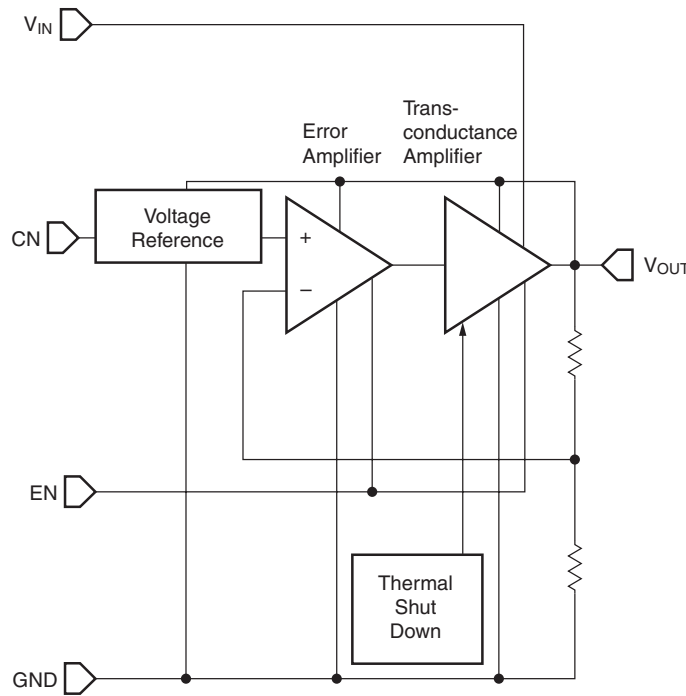

Figure 1.

## Test circuit

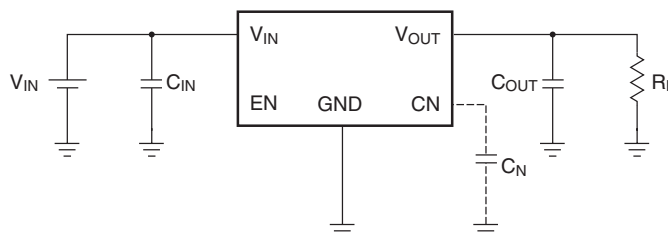

Figure 2.

## Pin Configuration

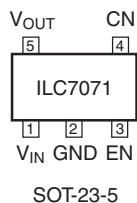

Figure 3.

## Pin Definition

Pin Number	Pin Name	Pin Function Description
1	V <sub>IN</sub>	<b>Supply voltage input</b>
2	GND	<b>Ground of the IC</b>
3	EN	<b>Enable input.</b> High level enables V <sub>OUT</sub> while Low level commands shutdown mode and discharge C <sub>OUT</sub> to GND
4	CN	<b>Optional noise bypass capacitor</b>
5	V <sub>OUT</sub>	<b>Voltage output.</b> Regulated output voltage

## Absolute Maximum Ratings

Absolute maximum ratings are the values beyond which the device may be damaged or have its useful life impaired. Functional operation under these conditions is not implied.

Parameter	Min.	Max.	Units
Supply Voltage:		10	V
EN Input Voltage	-0.3	$V_{IN} + 0.3$	V
Output Voltage	-0.3	$V_{IN} + 0.3$	V
Junction Temperature ( $T_J$ )		125, Internally limited	°C
Storage Temperature	-40	150	°C
Lead Soldering Temperature, 10 seconds		300	°C
Power Dissipation ( $P_D$ )		150	mW

## Recommended Operating Conditions

Parameter	Conditions	Min.	Typ.	Max.	Units
Supply Voltage $V_{DD}$	$V_{IN}$ to GND	$V_{OUT} + V_{DO}$	$V_{OUT} + 1$	$V_{OUT} + 4$	V
Peak Output Current	$I_{OUT}$ to GND, $t_{pw} = 2\text{mS}$			150	mA
Ambient Operating Temperature	$T_A$	-40		85	°C

## Electrical Specifications

$V_{IN}=V_{OUT}+1V$ ,  $I_{OUT}=1mA$ ,  $V_{EN}=2V$  and  $T_A = +25^{\circ}C$  using circuit in Figure 2 with  $C_{IN}=C_{OUT}=1\mu F$ ,  $C_N=0$ , unless otherwise specified

Parameter	Symbol	Conditions	Min.	Typ.	Max.	Units
Output Voltage	$V_{OUT}$		0.99 $V_{OUTnom}$	$V_{OUTnom}$	1.01 $V_{OUTnom}$	V
Ground pin Current	$I_{GND}$	$I_{OUT} = 10mA$		70	90	$\mu A$
		$I_{OUT} = 100mA$		90	110	
Line Regulation	$\frac{\Delta V_{OUT}}{V_{OUT}} / \frac{\Delta V_{IN}}{V_{IN}}$	$V_{OUT} + 2V \geq V_{IN} \geq V_{OUT} + 1V$		0.017	0.075	%/V
Load Regulation	$\frac{\Delta V_{OUT}}{V_{OUT}}$	$I_{OUT}=1$ to 100mA		0.15	0.25	%
Dropout Voltage. Notes 1 and 2	$V_{DO}$	$I_{OUT} = 10mA, V_{OUT} > 2.8V$		25	30	mV
		$I_{OUT} = 20mA, V_{OUT} > 2.8V$		50	60	
		$I_{OUT} = 100mA, V_{OUT} > 2.8V$		275	320	
Shutdown (OFF) current	$I_{OFF}$	$V_{EN} = 0$		10	40	nA
EN Input Voltage	$V_{EN}$	High = ON state Low = OFF state	2		0.6	V
EN Input Current	$I_{EN}$	$V_{EN} = 0.6V$		0.3		$\mu A$
		$V_{EN} = 2V$		1		
Output Noise Voltage	eN	BW = 300Hz to 50kHz $C_{IN} = C_{OUT} = 2.2\mu F$ $I_{OUT} = 10mA, C_N = 10nF$		40		$\mu V$ RMS
Ripple Rejection	PSRR	$C_{OUT} = 4.7\mu F, f = 120Hz$ $I_{OUT} = 80mA$		65		dB
Dynamic Line Regulation	$\Delta V_{OUT}(line)$	$\Delta V_{IN} = 1V, I_{OUT} = 10mA,$ $tr/tf = 2\mu S$		10		mV
Dynamic Load Regulation	$\Delta V_{OUT}(load)$	$\Delta I_{OUT} = 100mA, tr < 5\mu S$		20		mV
Resistance Discharge in OFF state	$R_{DISC}$	$V_{EN} = 0$		1.5		k $\Omega$

### Notes:

- For  $2.5V < V_{OUT} < 2.8V$  refer to diagram "Dropout Voltage vs. Output Voltage".
- Dropout Voltage is defined as the input to output differential voltage at which the output voltage drops 2% below the nominal value measured with 1V differential.

# Typical Applications Diagrams

**Short Circuit Thermal Protection**  
 $V_{IN} = V_{OUTnom} + 1V$   
Output to GND

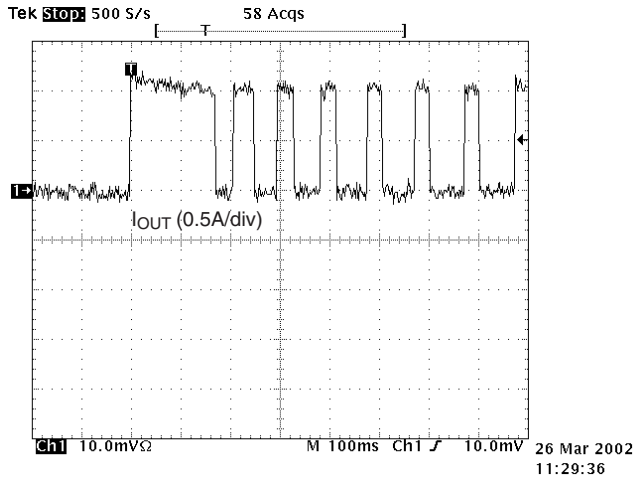

**Load Transient Response**  
 $V_{IN} = V_{OUT} + 1V, CN=0$

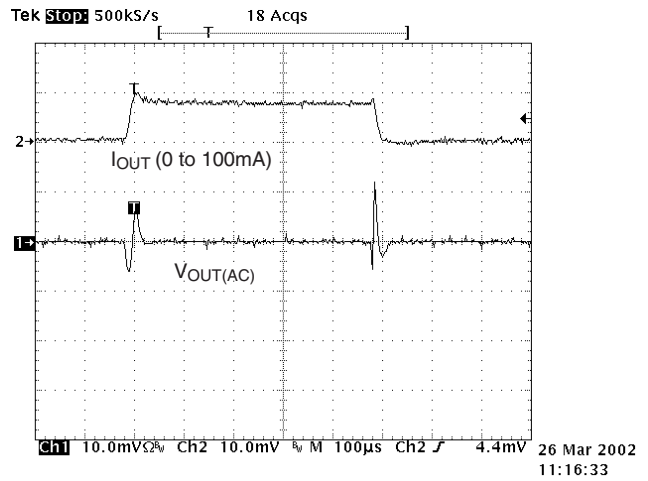

**Line Transient Response**  
 $\Delta V_{IN} = V_{OUT} + 1V$  to  $V_{OUT} + 2V$   
Load=10mA,  $C_{OUT}=2.2\mu F$

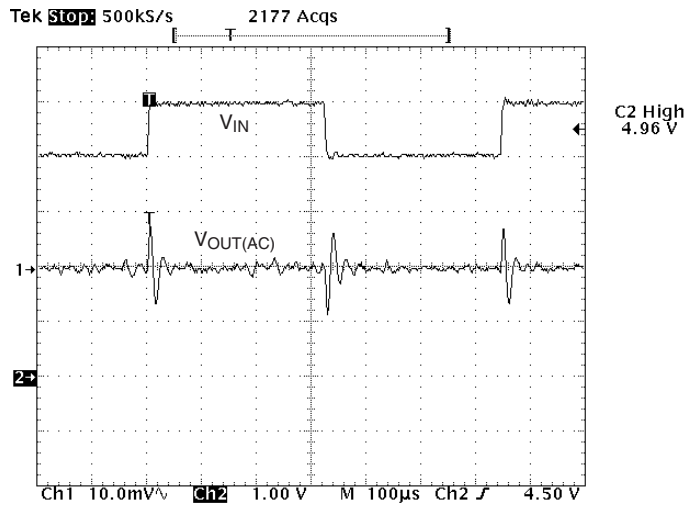

**ON/OFF Transient Response**  
Load=80mA,  
 $C_{OUT}=1\mu F, CN=0$

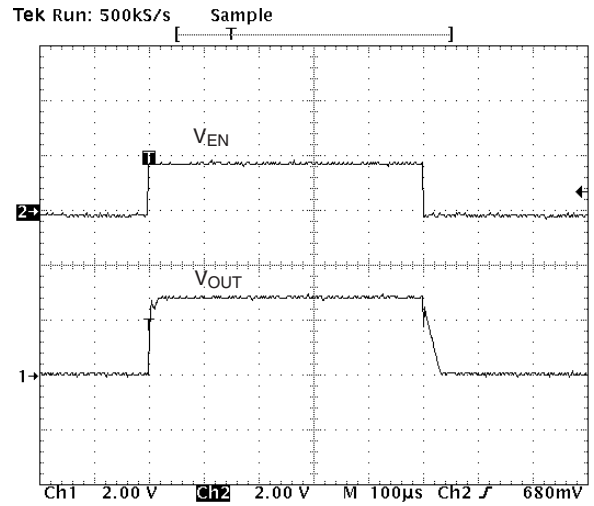

**ON/OFF Transient Response**  
 Load=10mA, C<sub>OUT</sub>=1μF, C<sub>N</sub>=10nF

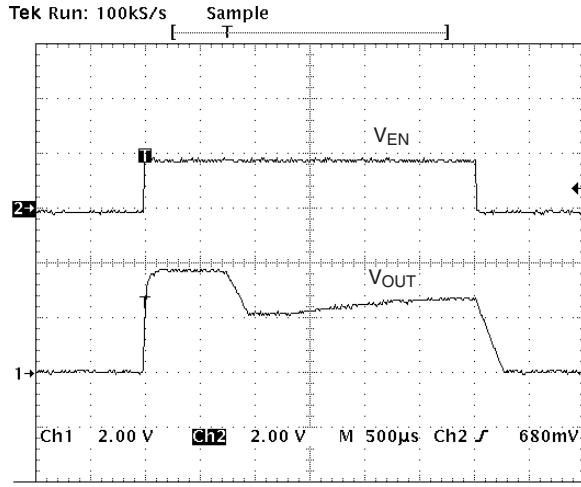

**ON/OFF Transient Response**  
 Load=10mA, C<sub>OUT</sub>=1μF, C<sub>N</sub>=0

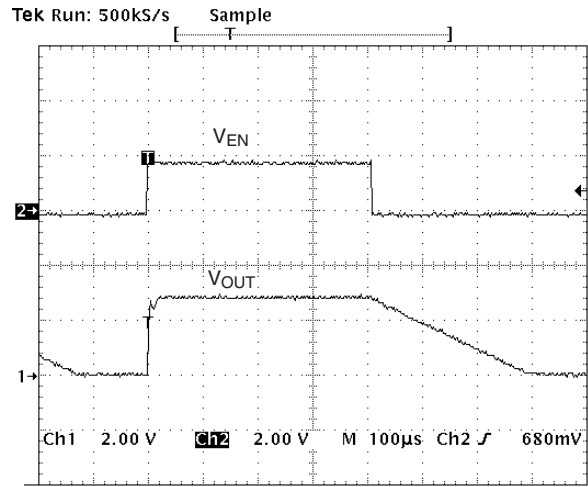

**Ground Current**

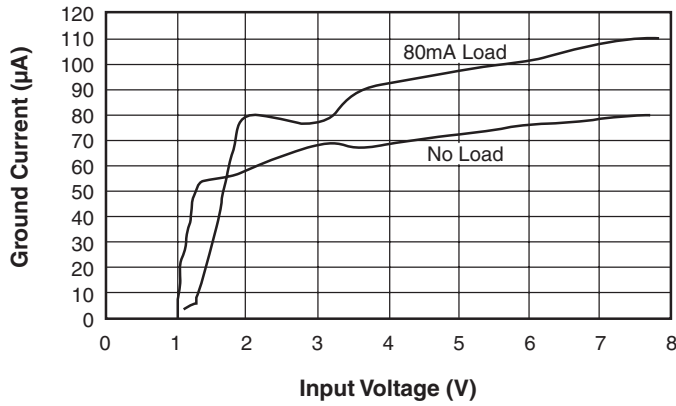

**Dropout Voltage vs. Output Voltage**

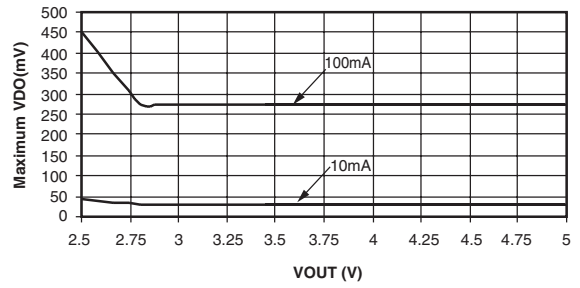

**Output Voltage**

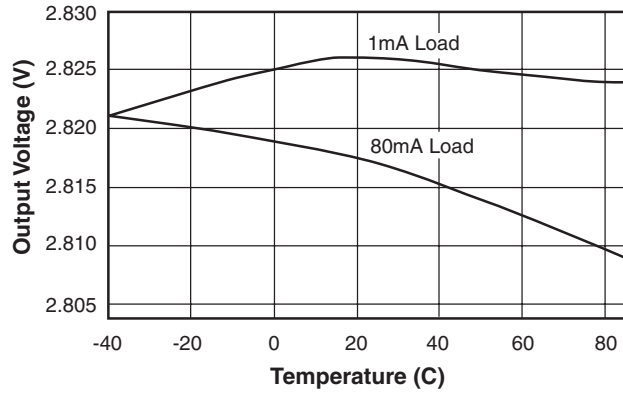

**Dropout Voltage**

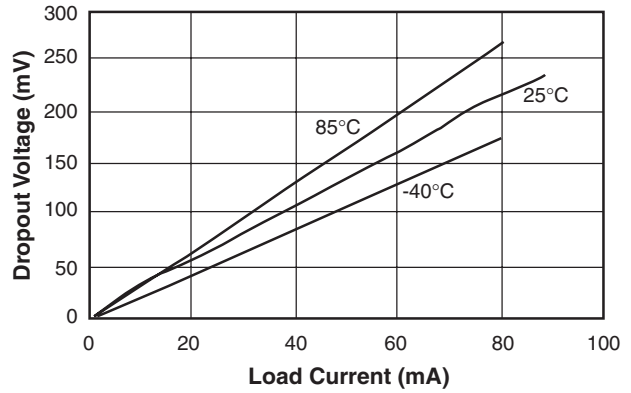

**Ripple Rejection**  
**Load=10mA, C<sub>OUT</sub>=4.7μF**

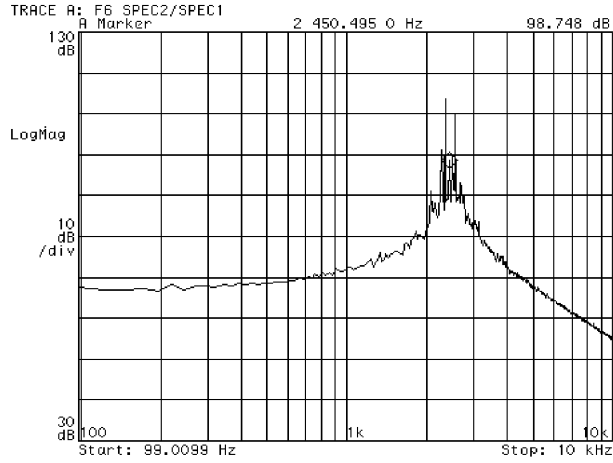

**Ripple Rejection**  
**Load=80mA, C<sub>OUT</sub>=4.7μF**

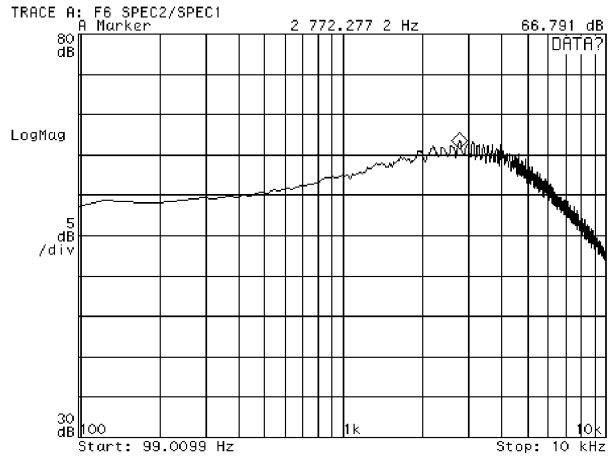

**Spectral Noise Density and Output Voltage Noise**  
**C<sub>IN</sub>=C<sub>OUT</sub>=2.2μF, C<sub>N</sub>=10nF,**  
**V<sub>IN</sub>=V<sub>OUT</sub>+1V, I<sub>OUT</sub>=10mA**

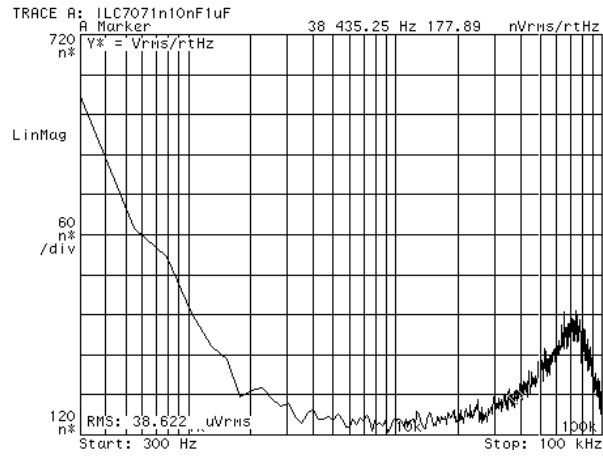

## Application Information

### Capacitor Selection

In general, ceramic capacitors are preferred due to their superior ESR performance. Those with X5R dielectric offer the best temperature coefficient.

An input capacitor of 1 $\mu$ F or greater, connected between Input and Ground, located in close proximity to the device will improve the transient response and the noise rejection.

An output capacitor of at least 1 $\mu$ F is required to maintain regulator loop stability. Stable operation will be achieved with a wide variety of capacitors with ESR ranging from 10m $\Omega$  to 10 $\Omega$ .

An optional capacitor connected between the CN pin and ground can significantly reduce noise on the output. Values ranging up to 10nF can be used, depending upon the sensitivity to output noise in the application. Care should be taken to prevent noise from external sources to enter into the CN pin, which is a very sensitive, high impedance pin. Leakage currents into this pin will directly affect the regulator accuracy and should be kept as low as possible.

### Control Functions

#### Enable Pin

Applying a voltage of 0.6V or less at the Enable pin will disable the output, reducing the quiescent output current to less than 1 $\mu$ A, while a voltage of 2V or greater will enable the device. If this shutdown function is not needed, the pin can simply be connected to the V<sub>IN</sub> pin. Allowing this pin to float will cause erratic operation.

#### Thermal Protection

The ILC7071 is designed to supply high peak output currents for brief periods, however this output load will cause the device temperature to increase and exceed maximum ratings due to power dissipation. During output overload conditions, when the die temperature exceeds the shutdown limit temperature of 125 °C, onboard thermal protection will disable the output until the temperature drops below this limit, at which point the output is then re-enabled.

During a thermal shutdown situation the user may assert the power-down function at the Enable pin, reducing power consumption to the minimum level.

### Thermal Characteristics

The ILC7071 is designed to supply up to 100mA at the specified output voltage with an operating die (junction) temperature of up to 125 °C. While the power dissipation is calculated from known electrical parameters, the thermal resistance is a result of the thermal characteristics of the compact SOT-23-5 surface-mount package and the surrounding PC Board copper to which it is mounted.

The relationship describing the thermal behavior of the package is:

$$P_{D(max)} = \frac{T_{J(max)} - T_A}{\Theta_{JA}}$$

where  $T_{J(max)}$  is the maximum allowable junction temperature of the die, which is 125 °C, and  $T_A$  is the ambient operating temperature.  $\Theta_{JA}$  is dependent on the surrounding PC board layout and can be empirically obtained. While the  $\Theta_{JC}$  (junction-to-case) of the SOT-23-5 package is specified at 130 °C/W, the  $\Theta_{JA}$  of the minimum PWB footprint will be at least 235 °C/W.

This can be improved upon by providing a heat sink of surrounding copper ground on the PCB.

Depending on the size of the copper area, the resulting  $\Theta_{JA}$  can range from approximately 180 °C/W for one square inch, to nearly 130 °C/W for 4 square inches.

The addition of backside copper with through-holes, stiffeners, and other enhancements can also aid in reducing this value. The heat contributed by the dissipation of other devices located nearby must be included in design considerations.

Once the limiting parameters in the thermal relationship have been determined, the electrical design should be verified to ensure that the device remains within specified operating conditions.

If overload conditions are not considered, it is possible for the device to enter a thermal cycling loop, in which the circuit enters a shutdown condition, cools, re-enables, and then again overheats and shuts down repeatedly due to an unmanaged fault condition.

### General PCB Layout Considerations

To achieve the full performance of the device, careful circuit layout and grounding technique must be observed. Establishing a small local ground, to which the GND pin, the output and bypass capacitors are connected, is recommended, while the input capacitor should be grounded to the main ground plane.

The quiet local ground is then routed back to the main ground plane using feedthrough vias.

In general, the high frequency compensation components (input, bypass, and output capacitors) should be located as close to the device as possible.

The proximity of the output capacitor is especially important to achieve optimal noise compensation from the onboard error amplifier, especially during high load conditions.

A large copper area in the local ground will provide the heat sinking discussed above when high power dissipation significantly increases the temperature of the device.

Component-side copper provides significantly better thermal performance for this surface-mount device, compared to that obtained when using only copper planes on the underside.

# Mechanical Dimensions

## 5 Lead SOT-23-5

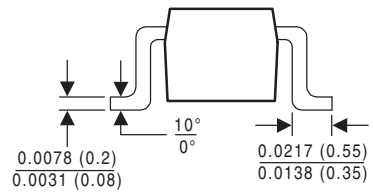
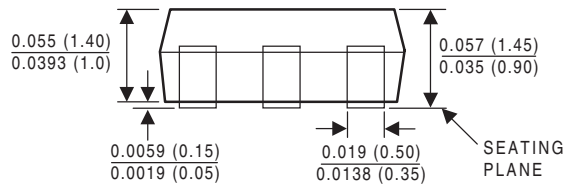
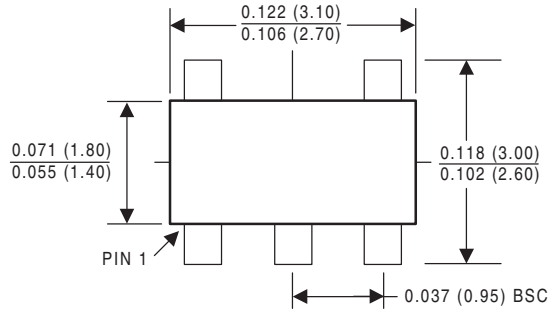

## Ordering Information

Output Voltage	Part Number	Temperature Range	Package
2.5	ILC7071AIM525X	-40 to 85°C	SOT-23-5
2.6	ILC7071AIM526X	-40 to 85°C	SOT-23-5
2.7	ILC7071AIM527X	-40 to 85°C	SOT-23-5
2.8	ILC7071AIM528X	-40 to 85°C	SOT-23-5
2.85	ILC7071AIM5285X	-40 to 85°C	SOT-23-5
2.9	ILC7071AIM529X	-40 to 85°C	SOT-23-5
3.0	ILC7071AIM530X	-40 to 85°C	SOT-23-5
3.1	ILC7071AIM531X	-40 to 85°C	SOT-23-5
3.3	ILC7071AIM533X	-40 to 85°C	SOT-23-5

### DISCLAIMER

FAIRCHILD SEMICONDUCTOR RESERVES THE RIGHT TO MAKE CHANGES WITHOUT FURTHER NOTICE TO ANY PRODUCTS HEREIN TO IMPROVE RELIABILITY, FUNCTION OR DESIGN. FAIRCHILD DOES NOT ASSUME ANY LIABILITY ARISING OUT OF THE APPLICATION OR USE OF ANY PRODUCT OR CIRCUIT DESCRIBED HEREIN; NEITHER DOES IT CONVEY ANY LICENSE UNDER ITS PATENT RIGHTS, NOR THE RIGHTS OF OTHERS.

### LIFE SUPPORT POLICY

FAIRCHILD'S PRODUCTS ARE NOT AUTHORIZED FOR USE AS CRITICAL COMPONENTS IN LIFE SUPPORT DEVICES OR SYSTEMS WITHOUT THE EXPRESS WRITTEN APPROVAL OF THE PRESIDENT OF FAIRCHILD SEMICONDUCTOR CORPORATION. As used herein:

1. Life support devices or systems are devices or systems which, (a) are intended for surgical implant into the body, or (b) support or sustain life, and (c) whose failure to perform when properly used in accordance with instructions for use provided in the labeling, can be reasonably expected to result in a significant injury of the user.
2. A critical component in any component of a life support device or system whose failure to perform can be reasonably expected to cause the failure of the life support device or system, or to affect its safety or effectiveness.

## Looking for pricing, stock, or lifecycle information?

Click below to explore more details on WIN SOURCE:

- ⊖ [View ILC7071AIM529X on WIN SOURCE](#)
- ⊖ [Fairchild/ON Semiconductor Information](#)

## Optimize Your Supply Chain with WIN SOURCE Solutions

- ✓ Global Sourcing Solution
- ✓ Obsolete Management
- ✓ Cost Control Management
- ✓ Shortage Management
- ✓ Alternative Solution
- ✓ Excess Inventory Management