

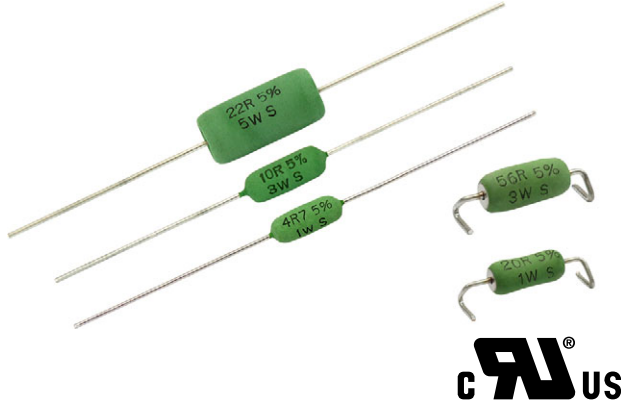

**THE DATASHEET OF  
AC03000006809JACCS**



## Axial Leaded, WSZ (SMD) Cemented Fusible Wirewound Safety Resistors

**LINKS TO ADDITIONAL RESOURCES**

**FEATURES**

- UL1412 recognized; UL file no. E362452
- AEC-Q200 qualified
- Flameproof insulation coating meets UL 94 V-0 requirements
- Impulse voltage handling capability (up to 6 kV) (1.2 / 50  $\mu$ s pulse in IEC 61000-4-5)
- Silent and safe fusing
- WSZ-form lead bending available for SMD mounting
- Material categorization: for definitions of compliance please see [www.vishay.com/doc?99912](http://www.vishay.com/doc?99912)



**RoHS**  
COMPLIANT  
HALOGEN  
**FREE**  
**GREEN**  
(5-2008)

**APPLICATIONS**

- Automotive electronics
- Energy meters
- White goods
- Power supplies

ACxx-CS series wirewound safety resistors are designed to be used as fusible safety resistors (or AC mains input resistors). The resistor fuses “without a bang” when AC mains voltage is applied <sup>(1)</sup>. At the same time, it acts as an in-rush current limiting resistor for normal operation. The specially developed lacquer coating has superior thermal and electrical insulating properties. This allows designers to more easily meet the requirements of safety approval, whilst eliminating the need to put additional fuses in series with the input resistor.

**Note**

<sup>(1)</sup> For ohmic values below 3R9, silent fusing is not established when AC mains voltage of 120 V<sub>RMS</sub> / 240 V<sub>RMS</sub> is applied

STANDARD ELECTRICAL SPECIFICATIONS						
TYPE	POWER RATING $P_{40}$	POWER RATING $P_{70}$	LIMITING VOLTAGE $U_{max.}$ V	RESISTANCE RANGE <sup>(1)</sup>	TOLERANCE	TEMPERATURE COEFFICIENT
AC01-CS	1.1 W	1 W	$\sqrt{P \times R}$	1 $\Omega$ to 100 $\Omega$	$\pm 5 \%$	$\pm 200$ ppm/K
AC03-CS	3 W	2.7 W	$\sqrt{P \times R}$	1 $\Omega$ to 100 $\Omega$	$\pm 5 \%$	$\pm 200$ ppm/K
AC05-CS	5 W	4.5 W	$\sqrt{P \times R}$	1 $\Omega$ to 100 $\Omega$	$\pm 5 \%$	$\pm 200$ ppm/K

**Note**

<sup>(1)</sup> Resistance value to be selected for  $\pm 5 \%$  from E24 series

TECHNICAL SPECIFICATIONS			
DESCRIPTION	AC01-CS	AC03-CS	AC05-CS
Operating temperature range	-40 °C to 200 °C		
Max. resistance change for 116 % of $P_{70}$ , $\Delta R$ max., after 1000 h:	$\pm (5 \% R + 0.1 \Omega)$		

SAFETY REQUIREMENTS AND QUALIFICATIONS				
SAFETY REQUIREMENTS / QUALIFICATIONS	UL	AEC-Q200		
DESCRIPTION	UL1412 recognized; UL file no. E362452	AC01-CS axial	AC03-CS axial	AC05-CS axial
	AC01-CS, AC03-CS, AC05-CS	AC01-CS WSZ	AC03-CS WSZ	-



PART NUMBER AND PRODUCT DESCRIPTION																	
Part Number: AC03000002209JACCS AC03000902209JBMCS																	
A	C	0	3	0	0	0	0	0	2	2	0	9	J	A	C	C	S
TYPE	VERSION	TCR/MATERIAL	RESISTANCE	TOLERANCE	PACKAGING	SPECIAL											
AC01 = AC01000 AC03 = AC03000 AC05 = AC05000	0 = neutral 1 = radial taped 9 = WSZ (Z formed leads for AC01-CS / AC03-CS)	0 = neutral	3 digit value 1 digit multiplier MULTIPLIER 8 = *10 <sup>-2</sup> 9 = *10 <sup>-1</sup> 0 = *10 <sup>0</sup>	J = ± 5 %	AC 6B 6F R1 RB BM	CS = safety											
Product Description: AC03-CS 22R 5 % AC G63 CDxxxx AC03-CS WSZ 22R 5 % BM CD1420																	
AC03-CS	22R	5 %	AC	G63	CDxxxx												
TYPE	RESISTANCE	TOLERANCE	PACKAGING	TAPE WIDTH	SPECIAL												
AC01-CS AC03-CS AC05-CS		± 5 %	AC 6B 6F R1 RB BM	G63 G83 G93													

Note

- Former variants A = ≤ 4 kV or B = ≤ 6 kV for AC05-CS are not necessary for new ordering codes

PACKAGING							
TYPE	PACKAGING CODE	QUANTITY	PACKAGING STYLE	WIDTH	PITCH	DIMENSIONS	PART NUMBER VARIANT
AC01-CS	AC	500	Axial taped acc. to IEC 60286-1 fan-folded in a box	63 mm	10 mm	85 mm x 72 mm x 260 mm	0
	R1	1000	Radial formed, taped acc. to IEC 60286-2 on reel	-	-	365 mm x 370 mm x 60 mm	1
AC01-CS WSZ	BM	1250	Z formed, blister taped acc. to IEC 60286-3 on reel	-	8 mm	350 mm x 335 mm x 35 mm	9
AC03-CS	AC	500	Axial taped acc. to IEC 60286-1 fan-folded in a box	63 mm	10 mm	85 mm x 120 mm x 270 mm	0
	R1	1000	Radial formed, taped acc. to IEC 60286-2 on reel	-	-	365 mm x 370 mm x 60 mm	1
AC03-CS WSZ	BM	1250	Z formed, blister taped acc. to IEC 60286-3 on reel	-	8 mm	350 mm x 335 mm x 35 mm	9
AC05-CS	6B	250	Axial taped acc. to IEC 60286-1 fan-folded in a box	83 mm	15 mm	110 mm x 120 mm x 270 mm	0
	6F	250	Axial taped acc. to IEC 60286-1 fan-folded in a box	93 mm		120 mm x 120 mm x 270 mm	0
	RB	250	Radial formed, taped acc. to IEC 60286-2 on reel	-	-	365 mm x 370 mm x 67 mm	1



## DESCRIPTION

ACxx-CS wirewound safety resistor series is designed to be used as fusible safety resistor (or, AC mains input resistors). It uses specially selected resistive winding wire and special non-flammable silicone cement coating material to ensure safe and silent fusing operation in overload conditions.

The resistor fuses “without a bang” when AC mains voltage is applied <sup>(1)</sup>. At the same time, it acts as an in-rush current limiting resistor for the normal operation.

The specially developed lacquer coating has superior thermal and electrical insulating properties. This allows designers to more easily meet the requirements of safety approval, whilst eliminating the need to put additional fuses in series with the input resistor.

Production is strictly controlled and follows an extensive set of instructions established for reproducibility. Plated steel termination caps are firmly pressed on the ceramic rods. Connecting wires of electrolytic copper plated with 100 % pure matte tin are welded to the termination caps. Suitable resistive wire is selected as a winding material. An optimized number of windings are wound on a high grade ceramic body. The resistor elements are covered by a green protective coating designed for electrical, mechanical and climatic protection. The special coating provides ideal and silent fusing of the component in overload condition, without burning or explosion <sup>(1)</sup>.

The ohmic value, tolerance, rated dissipation is stamp marked. Also “S” is marked for safety version.

The result of the determined production is verified by an extensive testing procedure performed on 100 % of the individual resistors. Only accepted products are stuck directly on the adhesive tapes according to IEC 60286-1 for axial leaded version, or according to IEC 60286-2 for the radial version, or blister taped according to IEC 60286-3 for the WSZ version.

## MATERIALS

Vishay acknowledges the following systems for the regulation of hazardous substances:

- IEC 62474, Material Declaration for Products of and for the Electrotechnical Industry, with the list of declarable substances given therein <sup>(2)</sup>
- The Global Automotive Declarable Substance List (GADSL) <sup>(3)</sup>
- The REACH regulation (1907/2006/EC) and the related list of substances with very high concern (SVHC) <sup>(4)</sup> for its supply chain

## Notes

- <sup>(1)</sup> For ohmic values below 3R9, silent fusing is not established when AC mains voltage of 120 V<sub>RMS</sub> / 240 V<sub>RMS</sub> is applied
- <sup>(2)</sup> The IEC 62474 list of declarable substances is maintained in a dedicated database, which is available at <http://std.iec.ch/iec62474>
- <sup>(3)</sup> The Global Automotive Declarable Substance List (GADSL) is maintained by the American Chemistry Council and available at [www.gadsl.org](http://www.gadsl.org)
- <sup>(4)</sup> The SVHC list is maintained by the European Chemical Agency (ECHA) and available at <http://echa.europa.eu/candidate-list-table>
- <sup>(5)</sup> Other cleaning solvents with aggressive chemicals should be evaluated in actual cleaning process for their suitability

The products do not contain any of the banned substances as per IEC 62474, GADSL, or the SVHC list, see [www.vishay.com/how/leadfree](http://www.vishay.com/how/leadfree). Hence the products fully comply with the following directives:

- 2000/53/EC End-of-Life Vehicle Directive (ELV) and Annex II (ELV II)
- 2011/65/EU Restriction of the Use of Hazardous Substances Directive (RoHS) with amendment 2015/863/EU
- 2012/19/EU Waste Electrical and Electronic Equipment Directive (WEEE)

Vishay pursues the elimination of conflict minerals from its supply chain, see the Conflict Minerals Policy at [www.vishay.com/doc?49037](http://www.vishay.com/doc?49037)

## ASSEMBLY

The resistors are suitable for processing on automatic insertion equipment and cutting and bending machines. Excellent solderability is proven, even after extended storage. They are suitable for automatic soldering using wave or dipping.

The resistors are completely lead (Pb)-free, the pure matte tin plating provides compatibility with lead (Pb)-free and lead-containing soldering processes. The immunity of the plating against tin whisker growth, in compliance with IEC 60068-2-82, has been proven under extensive testing.

The encapsulant is resistant to cleaning solvent specified in IEC 60115-1 <sup>(5)</sup>. The suitability of conformal coatings, if applied, shall be qualified by appropriate means to ensure the long-term stability of the whole system.

## APPROVALS

These resistors AC01-CS, AC03-CS, and AC05-CS have UL 1412 recognition UL file no. E362452.

## RELATED PRODUCTS

For a correlated range of standard cemented wirewound resistors, please see:

AC, AC-AT, AC-NI series

“Standard: AC, AEC-Q200 Qualified: AC-AT, Non-Inductive AC-NI Cemented Leaded Wirewound Resistors”

[www.vishay.com/doc?28730](http://www.vishay.com/doc?28730)

For a correlated range of wirewound resistors with high pulse handling capability, please see:

Z300-Cxx series

“High Surge Axial Cemented Wirewound Resistors”

[www.vishay.com/doc?21027](http://www.vishay.com/doc?21027)



FUNCTIONAL PERFORMANCE

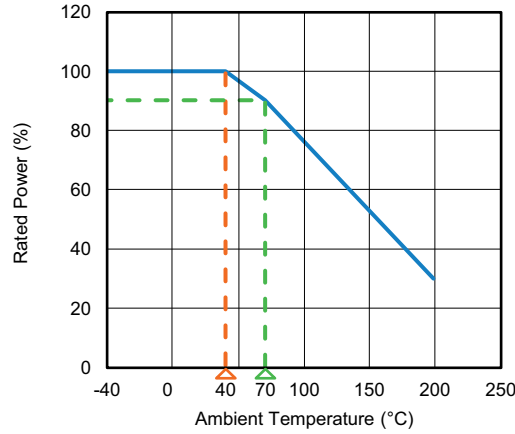

DERATING

Fusing time window defined against overload power applied.

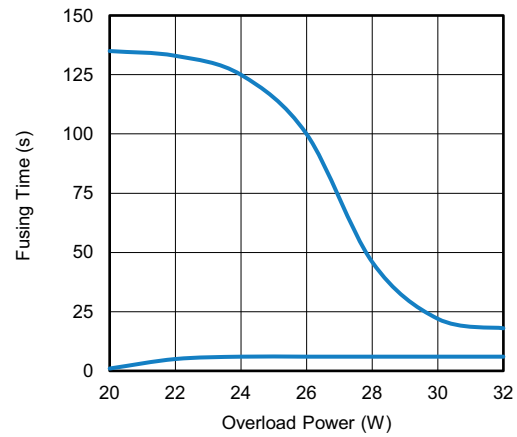
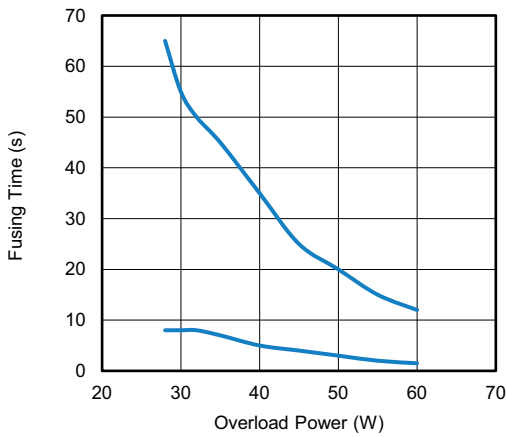

FUSING CHARACTERISTICS OF AC01-CS: 1 Ω ≤ R ≤ 2.7 Ω

FUSING CHARACTERISTICS OF AC01-CS: 3 Ω ≤ R ≤ 100 Ω

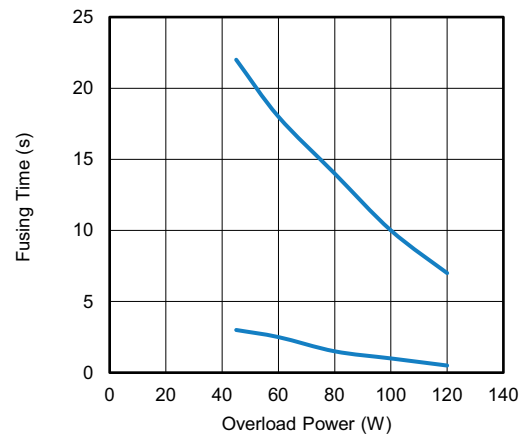
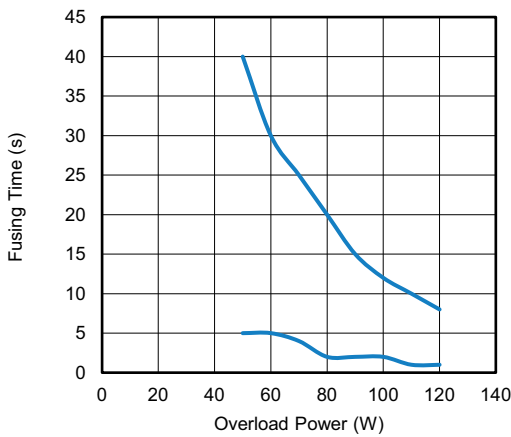

FUSING CHARACTERISTICS OF AC03-CS: 1 Ω ≤ R ≤ 4.3 Ω

FUSING CHARACTERISTICS OF AC03-CS: 4.7 Ω ≤ R ≤ 100 Ω



## FUNCTIONAL PERFORMANCE

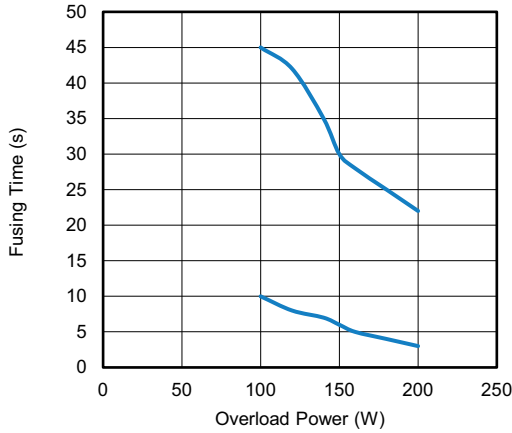

**FUSING CHARACTERISTICS OF AC05-CS: 1 Ω ≤ R ≤ 9.1 Ω**

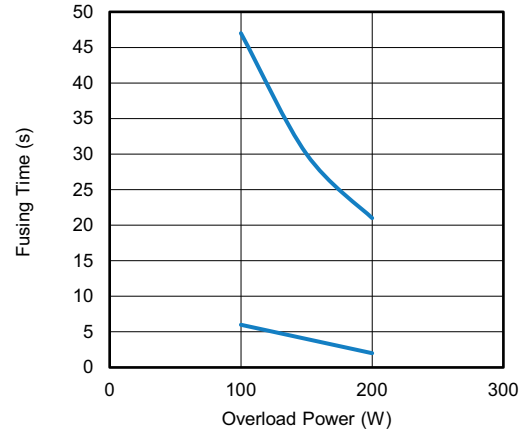

**FUSING CHARACTERISTICS OF AC05-CS: 10 Ω ≤ R ≤ 100 Ω**

Pulse energy curve defined against the offered ohmic range.

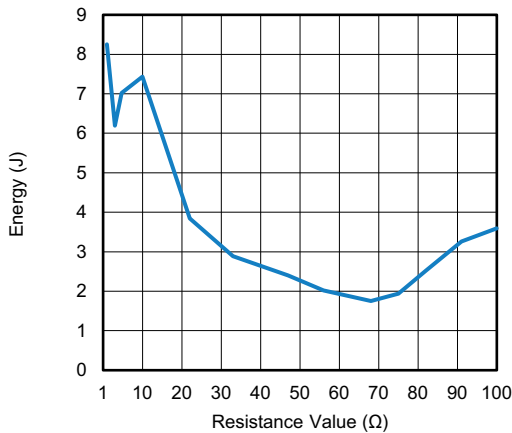

**PULSE ENERGY CURVE FOR AC01-CS**  
(1.2 / 50 μs; 10 pulses at 30 s interval)

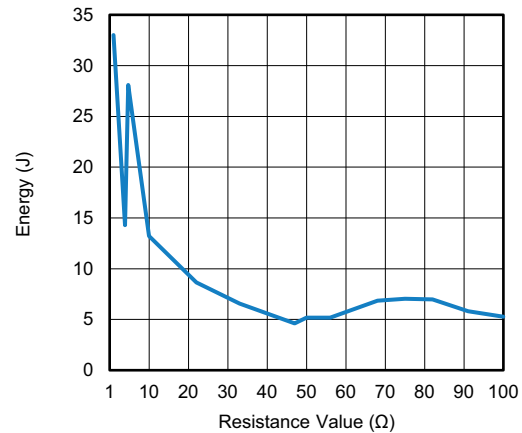

**PULSE ENERGY CURVE FOR AC03-CS**  
(1.2 / 50 μs; 10 pulses at 30 s interval)

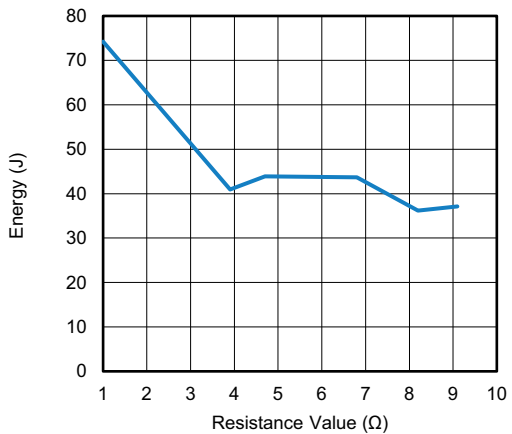

**PULSE ENERGY CURVE FOR AC05-CS: 1 Ω to 9.1 Ω**  
(1.2 / 50 μs; 10 pulses at 30 s interval)

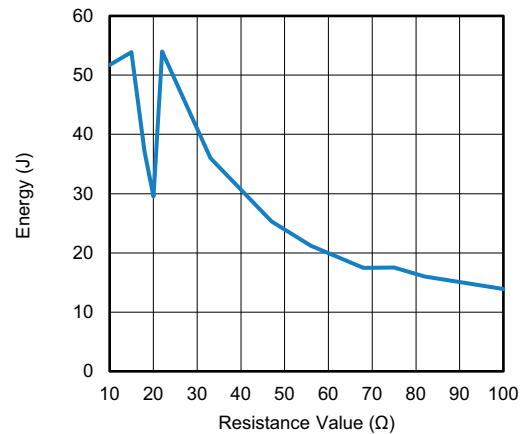

**PULSE ENERGY CURVE FOR AC05-CS: 10 Ω to 100 Ω**  
(1.2 / 50 μs; 10 pulses at 30 s interval)



FUNCTIONAL PERFORMANCE

Peak voltage (1.2 / 50 μs) graph defined against offered ohmic range.

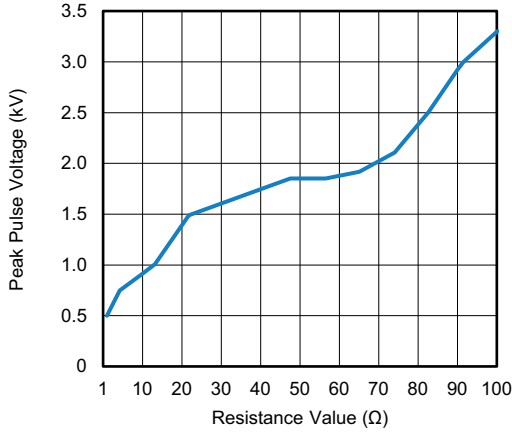

PEAK PULSE VOLTAGE LIMIT FOR AC01-CS (1.2 / 50 μs; 10 pulses at 30 s interval)

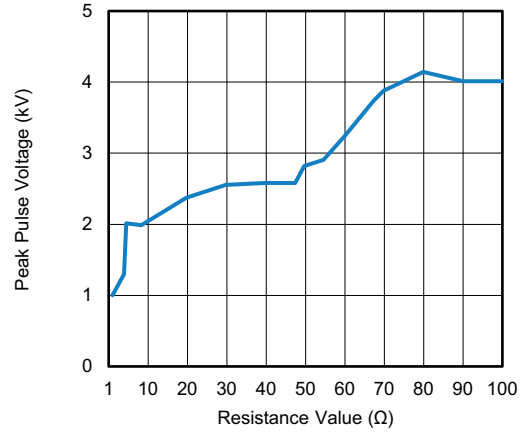

PEAK PULSE VOLTAGE LIMIT FOR AC03-CS (1.2 / 50 μs; 10 pulses at 30 s interval)

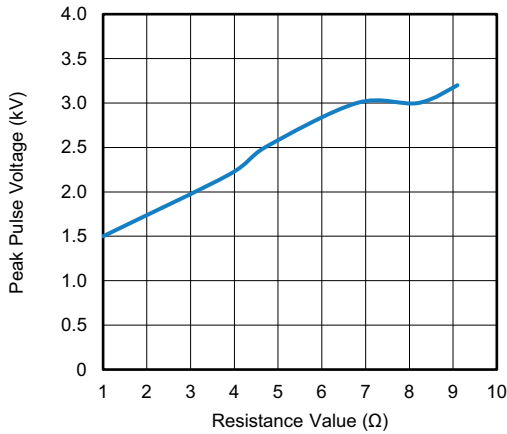

PEAK PULSE VOLTAGE LIMIT FOR AC05-CS: 1 Ω to 9.1 Ω (1.2 / 50 μs; 10 pulses at 30 s interval)

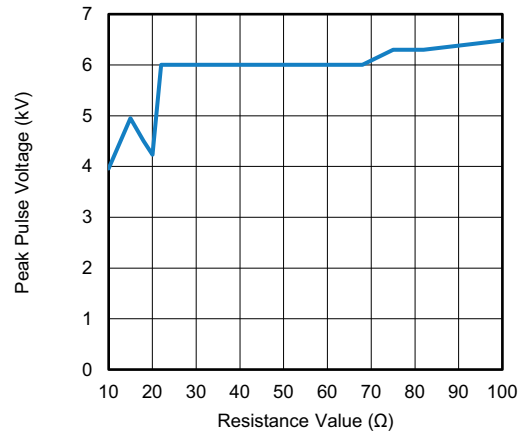

PEAK PULSE VOLTAGE LIMIT FOR AC05-CS: 10 Ω to 100 Ω (1.2 / 50 μs; 10 pulses at 30 s interval)



TESTS PROCEDURES AND REQUIREMENTS

All tests are carried out in accordance with the following specifications:

- IEC 60115-1, generic specification (includes tests)

The test and requirements table contains only the most important tests. For the full test schedule refer to the documents above.

The tests are carried out in accordance with IEC 60068-2-xx test method and under standard atmospheric conditions in accordance with IEC 60068-1, 5.3.

Climatic category -40 / 200 / 56 (rated temperature range: lower category temperature, upper category temperature; damp heat, steady state, test duration: 56 days) is valid.

Unless otherwise specified the following values apply:

- Temperature: 15 °C to 35 °C
• Relative humidity: 25 % to 75 %
• Air pressure: 86 kPa to 106 kPa (860 mbar to 1060 mbar)

For performing some of the tests, the components are mounted on a test board in accordance with IEC 60115-1, 5.5.

In test table below, only the relevant and commonly referred tests and related clauses of IEC 60115-1 and IEC 60068-2-xx test methods are mentioned.

Table with 5 columns: IEC 60115-1 CLAUSE, IEC 60068-2 TEST METHOD, TEST, PROCEDURE, REQUIREMENTS PERMISSIBLE CHANGE (ΔR\_MAX.). Rows include tests like Short time overload, Robustness of terminations, Resistance to soldering heat, Climatic sequence (Dry heat, Damp heat, Cold, Low air pressure, Damp heat remaining cyclic), Endurance, and Fail safe mains fusing.

Note

(1) For ohmic values below 3R9, silent fusing is not established when AC mains voltage of 120 V\_RMS / 240 V\_RMS is applied

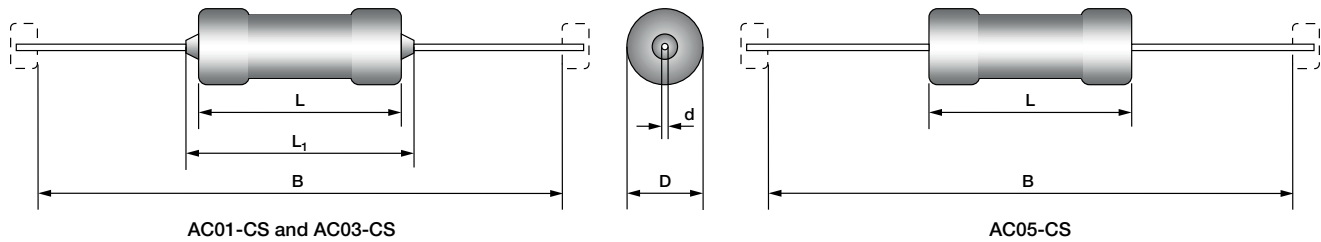
**DIMENSIONS**

<b>DIMENSIONS</b> - Leded resistor types, mass and relevant physical dimensions						
MODEL	L <sub>max.</sub>	L <sub>1 max.</sub>	D <sub>max.</sub>	d <sub>max.</sub>	B	MASS
AC01-CS <sup>(1)</sup>	11.0 mm	15.0 mm	5.0 mm	0.7 mm	63 mm	0.52 g
AC03-CS	13.0 mm	19.0 mm	6.0 mm	0.8 mm	63 mm	0.78 g
AC05-CS <sup>(2)</sup>	17.0 mm	17.0 mm	10.0 mm	0.8 mm	83 mm	2.25 g
					93 mm	2.5 g

**Notes**

- (1) For AC01-CS, dimension given is applicable for 10R to 100R; for lower ohmic values < 10R, D<sub>max.</sub> might reach 5.5 mm
- (2) For AC05-CS, L = L<sub>1</sub>; there is no lacquer on termination lead

**AC01-CS RADIAL**

Pitch of components 5.0 mm

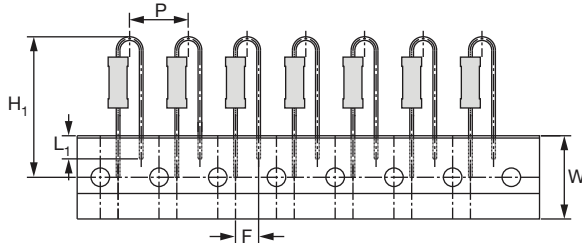

<b>DIMENSIONS</b> in millimeters		
Pitch of components	P	12.7 ± 1.0
Lead to lead distance	F	4.8 + 0.7 / - 0
Tape width	W	18 ± 0.5
Component height	H <sub>1</sub>	30.0 ± 3
Min. lead wire (tape portion) shortest lead	L <sub>1</sub>	2.5

**AC03-CS RADIAL**

Pitch of components 5.0 mm

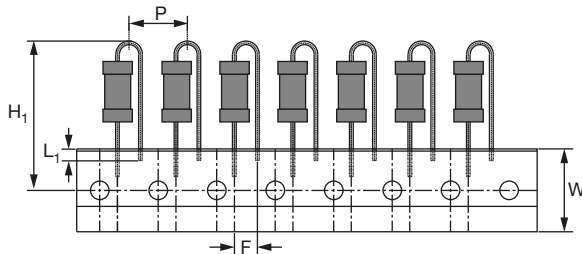

<b>DIMENSIONS</b> in millimeters		
Pitch of components	P	12.7 ± 1.0
Lead to lead distance	F	5.00 ± 0.5
Tape width	W	18 ± 0.5
Maximum component height	H <sub>1</sub>	34
Min. lead wire (tape portion) shortest lead	L <sub>1</sub>	2.5

**AC05-CS RADIAL**

Pitch of components 7.50 mm

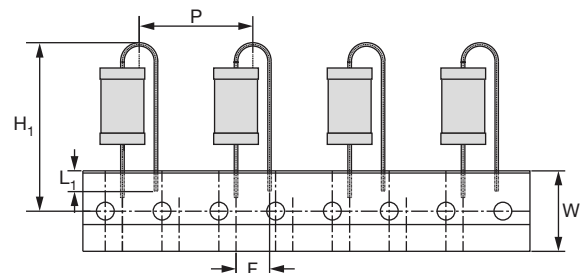

<b>DIMENSIONS</b> in millimeters		
Pitch of components	P	25.4 ± 1.0
Lead to lead distance	F	7.50 ± 0.5
Tape width	W	18 ± 0.5
Component height	H <sub>1</sub>	37 ± 2
Min. lead wire (tape portion) shortest lead	L <sub>1</sub>	2.5

**Z-FORM LEADS FOR SMD MOUNTING** in millimeters

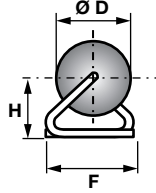
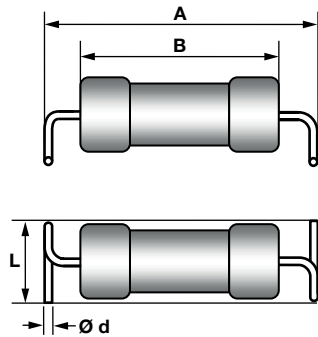
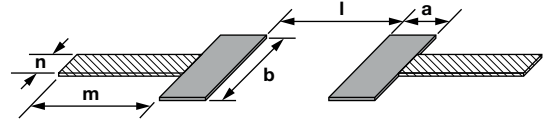
**LEAD BENDING  
STYLE = WSZ  
(Z-form)**

**Recommended solder pad dimensions**

TYPE WSZ	Ø d <sub>max.</sub>	Ø D <sub>max.</sub>	A	B <sub>max.</sub>	F	H	L	a	b	l	m <sup>(1)</sup>	n <sup>(1)</sup>
AC01-CS WSZ	0.7	5.0	17 ± 0.3	11.0	4.8 ± 0.3	3.6 ± 0.2	5.0 ± 0.5	4	8	12.2	25	2
AC03-CS WSZ	0.8	6.0	17 ± 0.3	13.0	4.8 ± 0.3	3.6 ± 0.2	5.0 ± 0.5	4	8	12.2	25	2

**Note**

- <sup>(1)</sup> Dimensions “m” and “n” represent minimum conducting track area in actual PCB, based on test conditions at full rated power. Customers need to reassess temperature restrictions based on the solder type, PCB material, and other factors specific to their application



## Disclaimer

ALL PRODUCT, PRODUCT SPECIFICATIONS AND DATA ARE SUBJECT TO CHANGE WITHOUT NOTICE TO IMPROVE RELIABILITY, FUNCTION OR DESIGN OR OTHERWISE.

Vishay Intertechnology, Inc., its affiliates, agents, and employees, and all persons acting on its or their behalf (collectively, "Vishay"), disclaim any and all liability for any errors, inaccuracies or incompleteness contained in any datasheet or in any other disclosure relating to any product.

Vishay makes no warranty, representation or guarantee regarding the suitability of the products for any particular purpose or the continuing production of any product. To the maximum extent permitted by applicable law, Vishay disclaims (i) any and all liability arising out of the application or use of any product, (ii) any and all liability, including without limitation special, consequential or incidental damages, and (iii) any and all implied warranties, including warranties of fitness for particular purpose, non-infringement and merchantability.

Statements regarding the suitability of products for certain types of applications are based on Vishay's knowledge of typical requirements that are often placed on Vishay products in generic applications. Such statements are not binding statements about the suitability of products for a particular application. It is the customer's responsibility to validate that a particular product with the properties described in the product specification is suitable for use in a particular application. Parameters provided in datasheets and / or specifications may vary in different applications and performance may vary over time. All operating parameters, including typical parameters, must be validated for each customer application by the customer's technical experts. Product specifications do not expand or otherwise modify Vishay's terms and conditions of purchase, including but not limited to the warranty expressed therein.

Hyperlinks included in this datasheet may direct users to third-party websites. These links are provided as a convenience and for informational purposes only. Inclusion of these hyperlinks does not constitute an endorsement or an approval by Vishay of any of the products, services or opinions of the corporation, organization or individual associated with the third-party website. Vishay disclaims any and all liability and bears no responsibility for the accuracy, legality or content of the third-party website or for that of subsequent links.

Vishay products are not designed for use in life-saving or life-sustaining applications or any application in which the failure of the Vishay product could result in personal injury or death unless specifically qualified in writing by Vishay. Customers using or selling Vishay products not expressly indicated for use in such applications do so at their own risk. Please contact authorized Vishay personnel to obtain written terms and conditions regarding products designed for such applications.

No license, express or implied, by estoppel or otherwise, to any intellectual property rights is granted by this document or by any conduct of Vishay. Product names and markings noted herein may be trademarks of their respective owners.

## Looking for pricing, stock, or lifecycle information?

Click below to explore more details on WIN SOURCE:

⊖ View [AC03000006809JACCS](#) on WIN SOURCE

⊖ [Vishay](#) Information

## Optimize Your Supply Chain with WIN SOURCE Solutions

- ✓ Global Sourcing Solution
- ✓ Obsolete Management
- ✓ Cost Control Management
- ✓ Shortage Management
- ✓ Alternative Solution
- ✓ Excess Inventory Management