

Generation 6 CXM-14

COB Arrays White LED



Features

- High lumen output and efficacy typical
- Over 3450 lm, 145 LPW @ 3000K, 90CRI, $T_j = 85^\circ\text{C}$
- CCT range 2200K, 2400K, 2700K, 3000K, 3500K, 4000K, 5000K and 6500K
- 3 SDCM and 2 SDCM color binning standard
- Excellent optical emission uniformity and color over angle consistency
- Superior thermal conductivity for uniform heat spreading



Applications

- Spotlights/Track Lights
- Downlights
- Shop Lighting
- Hospitality Lighting
- Architectural and Specialty
- Street Lighting
- Parking Lot and Area Lighting
- Tunnel Lighting

Table of Contents

Ordering Information.	2
Binning Structure.	5
Absolute Maximum Ratings.	7
Characteristics	8
Angular Distribution and Typical Spectrum.	10
Derating Curve	11
Mechanical Dimensions.	12
Shipping Tray Outline	13
Shipping Label	14
Technology Overview.	15
Test Specifications	15
Handling Notes	16
Revision History.	18



Ordering Information

Ordering Part Numbers -TC60

The following tables describe products with typical flux and minimum flux measured at 720 mA and specified at $T_j = 85^\circ\text{C}$. The values at 25°C are calculated and shown for reference only.

Minimum-CRI ²	CCT	Luminous Flux ¹			Ordering Part Number	
		Typical Flux (85°C)	Minimum Flux (85°C)	Calculated Typical Flux (25°C)	3-step MacAdam Ellipse	2-step MacAdam Ellipse
90	2200K	2840	2640	3120	CXM-14-22-90-36-TC60-F7-3	CXM-14-22-90-36-TC60-F7-2
90	2400K	3085	2870	3395	CXM-14-24-90-36-TC60-F7-3	CXM-14-24-90-36-TC60-F7-2
80	2700K	3750	3485	4125	CXM-14-27-80-36-TC60-F7-3	CXM-14-27-80-36-TC60-F7-2
90		3330	3095	3660	CXM-14-27-90-36-TC60-F7-3	CXM-14-27-90-36-TC60-F7-2
95		2790	2595	3065	CXM-14-27-95-36-TC60-F7-3	CXM-14-27-95-36-TC60-F7-2
80	3000K	3955	3680	4350	CXM-14-30-80-36-TC60-F7-3	CXM-14-30-80-36-TC60-F7-2
90		3450	3210	3800	CXM-14-30-90-36-TC60-F7-3	CXM-14-30-90-36-TC60-F7-2
95		2940	2735	3235	CXM-14-30-95-36-TC60-F7-3	CXM-14-30-95-36-TC60-F7-2
80	3500K	4030	3750	4435	CXM-14-35-80-36-TC60-F7-3	CXM-14-35-80-36-TC60-F7-2
90		3540	3290	3895	CXM-14-35-90-36-TC60-F7-3	CXM-14-35-90-36-TC60-F7-2
95		3070	2855	3380	CXM-14-35-95-36-TC60-F7-3	CXM-14-35-95-36-TC60-F7-2
80	4000K	4120	3830	4530	CXM-14-40-80-36-TC60-F7-3	CXM-14-40-80-36-TC60-F7-2
90		3620	3365	3980	CXM-14-40-90-36-TC60-F7-3	CXM-14-40-90-36-TC60-F7-2
95		3240	3010	3560	CXM-14-40-95-36-TC60-F7-3	CXM-14-40-95-36-TC60-F7-2
80	5000K	4185	3895	4605	CXM-14-50-80-36-TC60-F7-3	CXM-14-50-80-36-TC60-F7-2
90		3615	3360	3975	CXM-14-50-90-36-TC60-F7-3	CXM-14-50-90-36-TC60-F7-2
95		3395	3155	3735	CXM-14-50-95-36-TC60-F7-3	CXM-14-50-95-36-TC60-F7-2
80	6500K	4055	3775	4465	CXM-14-65-80-36-TC60-F7-3	CXM-14-65-80-36-TC60-F7-2
90		3630	3375	3990	CXM-14-65-90-36-TC60-F7-3	CXM-14-65-90-36-TC60-F7-2

Notes:

1. Luminus maintains a +/- 6% tolerance on flux measurements.
2. Luminus maintains a +/- 2% tolerance on CRI measurements.



Ordering Information

Ordering Part Numbers - TC62 Sensus (BBBL)

The following tables describe products with typical flux and minimum flux measured at 720 mA and specified at $T_j = 85^\circ\text{C}$. The values at 25°C are calculated and shown for reference only.

Minimum-CRI ²	CCT	Luminous Flux ¹			Ordering Part Number	
		Typical Flux (85°C)	Minimum Flux (85°C)	Calculated Typical Flux (25°C)	3-step MacAdam Ellipse	2-step MacAdam Ellipse
90	2700K	3170	2945	3485	CXM-14-27-90-36-TC62-F7-3	CXM-14-27-90-36-TC62-F7-2
	3000K	3360	3125	3700	CXM-14-30-90-36-TC62-F7-3	CXM-14-30-90-36-TC62-F7-2
	3500K	3445	3205	3790	CXM-14-35-90-36-TC62-F7-3	CXM-14-35-90-36-TC62-F7-2

Notes:

1. Luminus maintains a +/- 6% tolerance on flux measurements.
2. Luminus maintains a +/- 2% tolerance on CRI measurements.



Ordering Information

Part Number Nomenclature

All Luminus COB products are packaged and labeled with part numbers as outlined in the table on page 2. Luminus may include any smaller chromaticity bin that is contained in the larger bin as part of the ordered part. When shipped, each package will contain only a single flux and chromaticity bin. The part number designation is as follows:

CXM	14	NN	XX	VV	QQPP	FG	W
Product Family	LES ¹	CCT ²	Minimum CRI ³	Typical Voltage	Package Configurator ⁴	Flux Bin	Chromaticity Bin
Chip on Board, Multi-die	14 mm LES diameter	See Note 2 below	80: CRI > 80 90: CRI > 90 95: CRI > 95	Volts (V) 36: 36V	TC60 TC62	Lumens	See page 5 for bins

Notes:

- Light Emitting Surface (LES) Diameter.
- Correlated Color Temperature (CCT), NN nomenclature corresponds to the following:

22 = 2200K	35 = 3500K
24 = 2400K	40 = 4000K
27 = 2700K	50 = 5000K
30 = 3000K	65 = 6500K
- Minimum Color Rendering Index (CRI).
- TC is a standard substrate with sulfur resistance process; 6 means generation 6 COB products, 0 means a product with chromaticity on the BBL, 2 means a product with chromaticity below BBL.
- Luminus part numbers may be accompanied by prefixes or suffixes. The most common is the "Rev01" suffix indicating a part is fully released and carries a full warranty. These additional characters may appear on shipping labels, packing slips and invoices. In all cases the basic part number described above will always be included.

CCT, CRI and R9 Values

Correlated Color Temperatures	XX Value	CRI	R9 ¹
2700K, 3000K, 3500K, 4000K, 5000K, 6500K	80	>80	>0
2200K, 2400K, 2700K, 3000K, 3500K, 4000K, 5000K, 6500K	90	>90	>50
2700K, 3000K	95	>95	>80
3500K, 4000K, 5000K			>70

Note:

- R9 values have a tolerance of +/- 5%.



Binning Structure

Chromaticity Binning Diagram ¹ - TC60

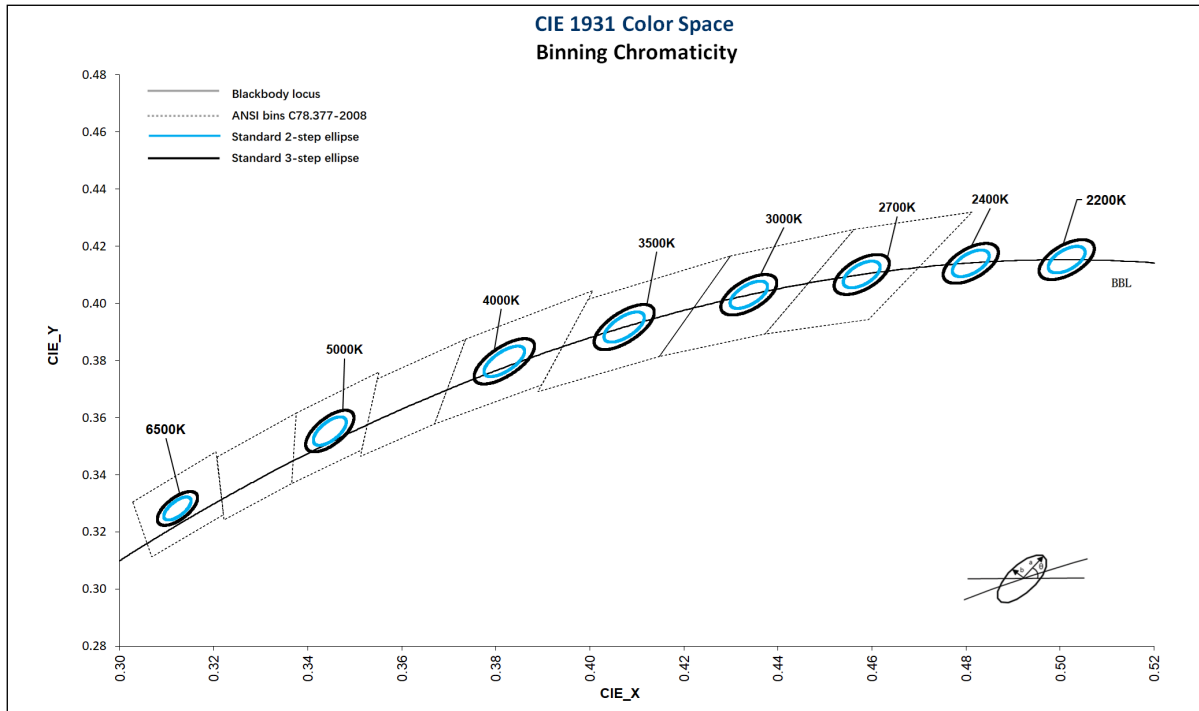

The following tables describe the chromaticity bin center points, the orientation angle for the MacAdam ellipse, and the maximum radii for the ellipses. The ANSI Bins are provided for reference.

CCT	Center point		Angle(deg)	3-step Bin		2-step Bin	
	x	y	Φ	a	b	a	b
2200K	0.5014	0.4153	53.7	0.0081	0.0042	0.0054	0.0028
2400K	0.4810	0.4140	53.7	0.0081	0.0042	0.0054	0.0028
2700K	0.4578	0.4101	53.7	0.0081	0.0042	0.0054	0.0028
3000K	0.4338	0.4030	53.2	0.0083	0.0041	0.0056	0.0027
3500K	0.4073	0.3917	54.0	0.0093	0.0041	0.0062	0.0028
4000K	0.3818	0.3797	53.7	0.0094	0.0040	0.0063	0.0027
5000K	0.3447	0.3553	59.6	0.0082	0.0035	0.0056	0.0024
6500K	0.3123	0.3282	58.6	0.0067	0.0029	0.0046	0.0019

Note:

1. Luminus maintains a +/- 0.005 tolerance on chromaticity (CIEx and CIEy) measurements.



Binning Structure

Chromaticity Binning Diagram ¹ - TC62 Sensus (BBBL)

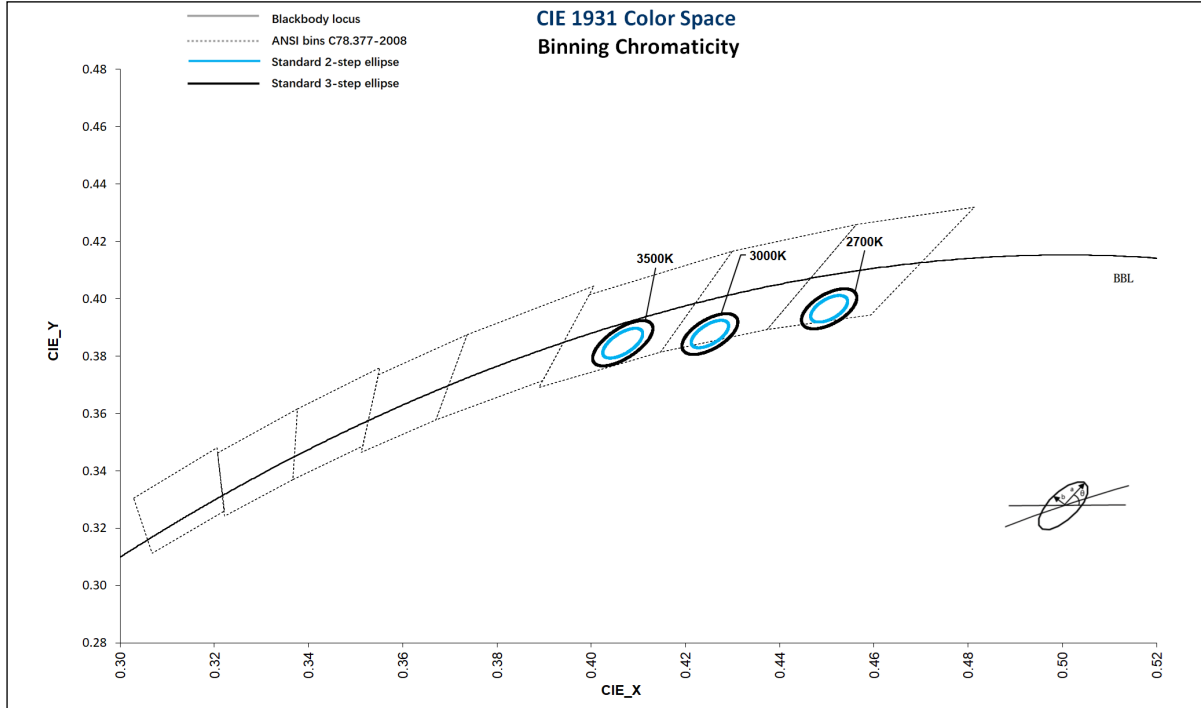

The following tables describe the chromaticity bin center points, the orientation angle for the MacAdam ellipse, and the maximum radii for the ellipses. The ANSI Bins are provided for reference.

CCT	Center point		Angle(deg)	3-step Bin		2-step Bin	
	x	y	Φ	a	b	a	b
2700K	0.4505	0.3965	53.7	0.0081	0.0042	0.0054	0.0028
3000K	0.4252	0.3877	53.6	0.0083	0.0041	0.0056	0.0027
3500K	0.4067	0.3845	54.0	0.0093	0.0041	0.0062	0.0028

Note:

1. Luminus maintains a +/- 0.005 tolerance on chromaticity (CIE_x and CIE_y) measurements.



Absolute Maximum Ratings

Parameter		Symbol	Value	Unit
Forward Current	Typical	$I_{f \text{ typ}}$	720	mA
	Maximum	$I_{f \text{ max}}$	1800	
Power Dissipation	Typical	$P_{d \text{ typ}}$	24.0	W
	Maximum	$P_{d \text{ max}}$	67.9	
Operating Case Temperature	Maximum	T_c	120	°C
Junction Temperature	Maximum	T_j	140	°C



Characteristics^{1,2,3}

Parameter		Symbol	Value	Unit
Light Emitting Surface Diameter		LES	14.5	mm
Forward Voltage	Minimum	$V_{f\ min}$	31.5	V
	Typical	$V_{f\ typ}$	33.3	
	Maximum	$V_{f\ max}$	37.7	
Thermal Resistance (junction-to-case)		$R_{th\ J-C}$	0.25	°C/W
Viewing Angle		$2\theta_{1/2}$	120	°

Notes:

1. Device measurements are at $T_j = 85^\circ\text{C}$.
2. To prevent damage refer to operating conditions and derating curves for appropriate maximum operating conditions
3. Voltage is rated at typical forward current. For voltage at higher drive current, refer to performance graphs.
4. Please use ray files for all optics designs.
5. Device operation not recommended at drive currents less than 10% of the typical value
6. Caution must be taken not to stare at the light emitted from these LEDs. Under special circumstances, the high intensity could damage the eye.
7. All product operating specifications are subject to change without advance notice.



Relative Luminous Flux vs Forward Current

$T_j = 85^\circ\text{C}$

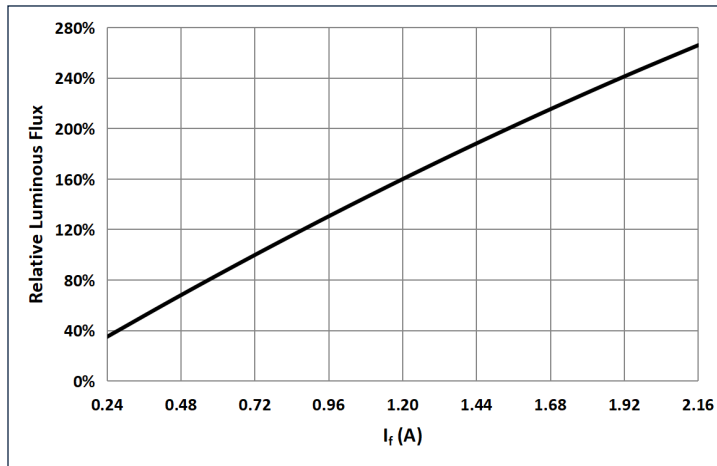

Relative Luminous Flux vs Temperature

$I_f = 720\text{ mA}$

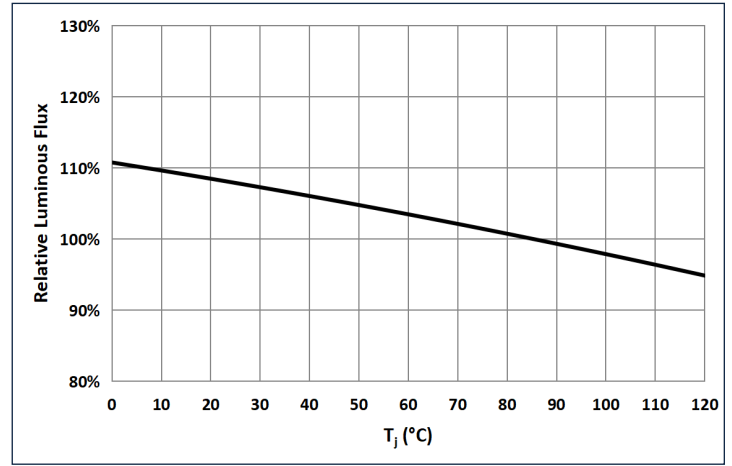

Forward Voltage vs Forward Current

$T_j = 85^\circ\text{C}$

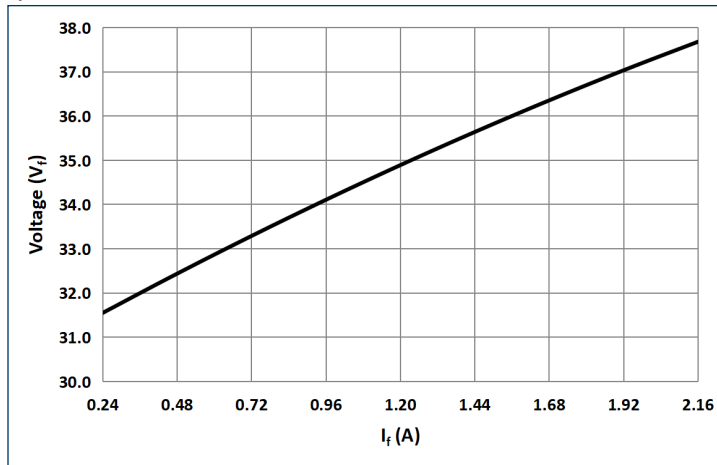

Forward Voltage vs Temperature

$I_f = 720\text{ mA}$

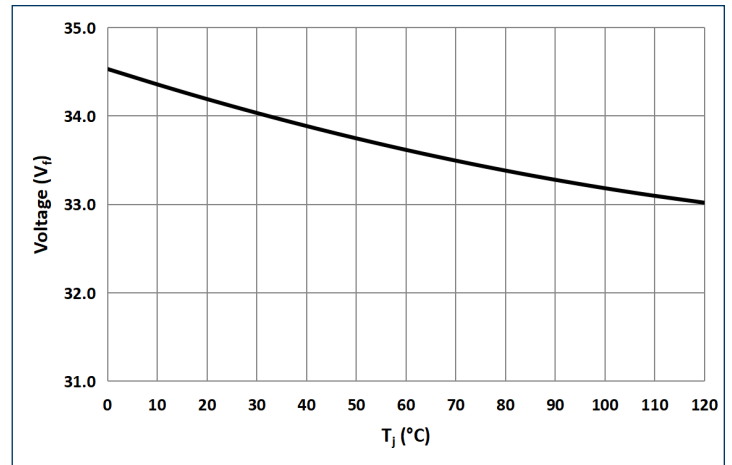

Relative Chromaticity vs Forward Current

$T_j = 85^\circ\text{C}$

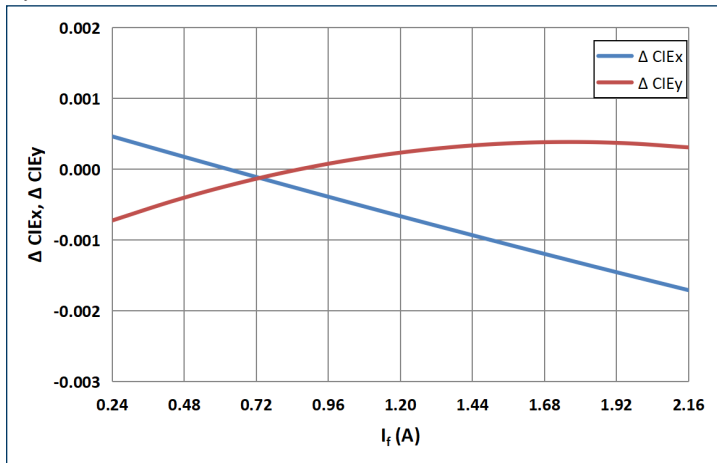

Relative Chromaticity vs Temperature

$I_f = 720\text{ mA}$

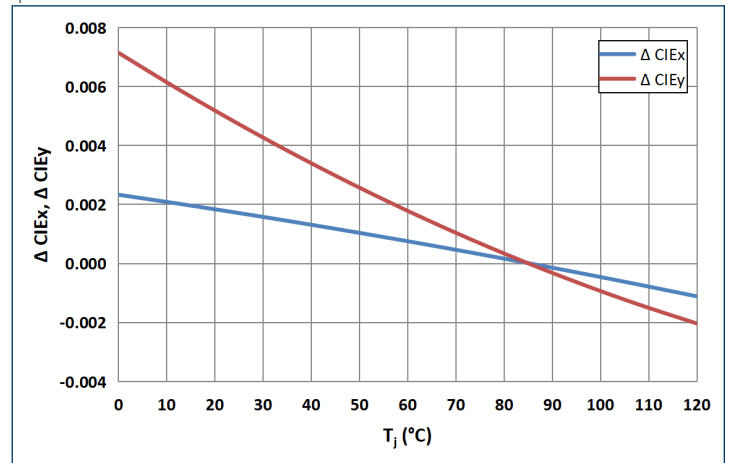



Angular Distribution and Typical Spectrum

Angular Distribution

$T_j = 85^\circ\text{C}$

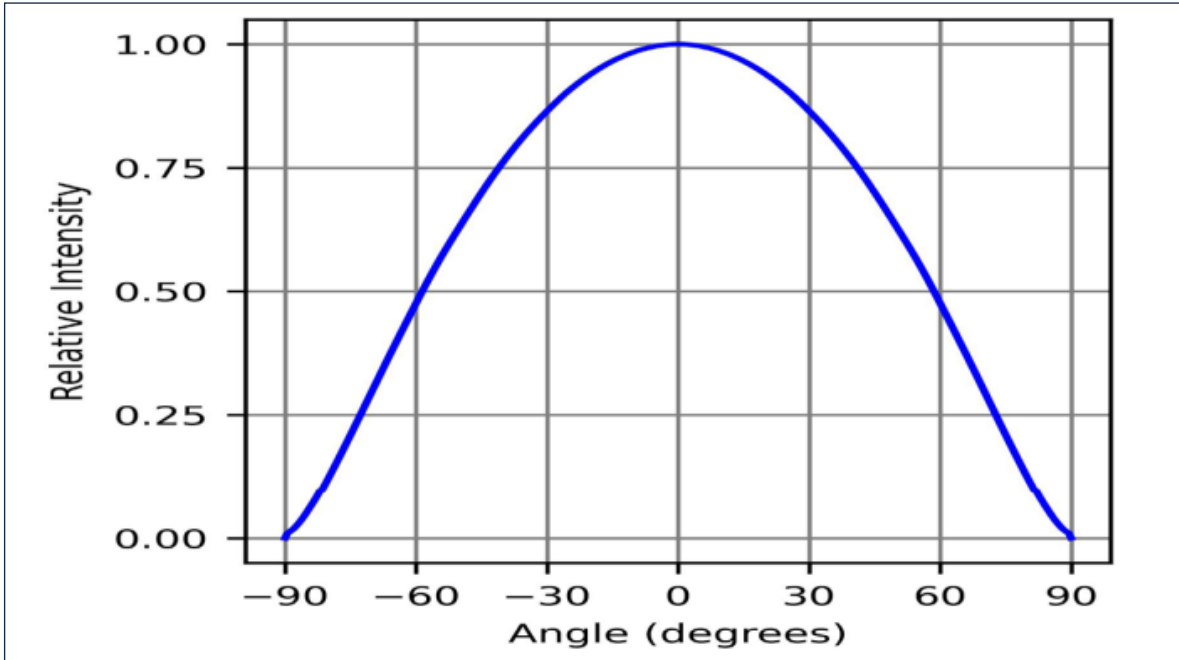

Polar Distribution

$T_j = 85^\circ\text{C}$

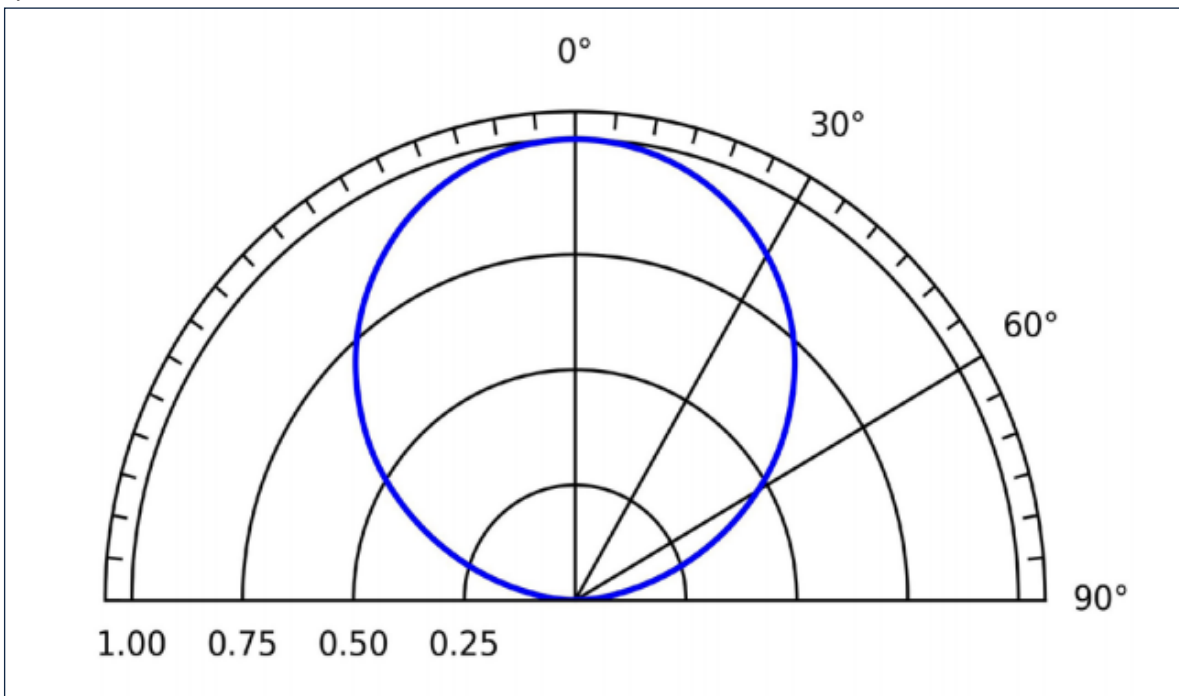



Angular Distribution and Typical Spectrum

Relative Spectral Power Distribution

$T_j = 85^\circ\text{C}$

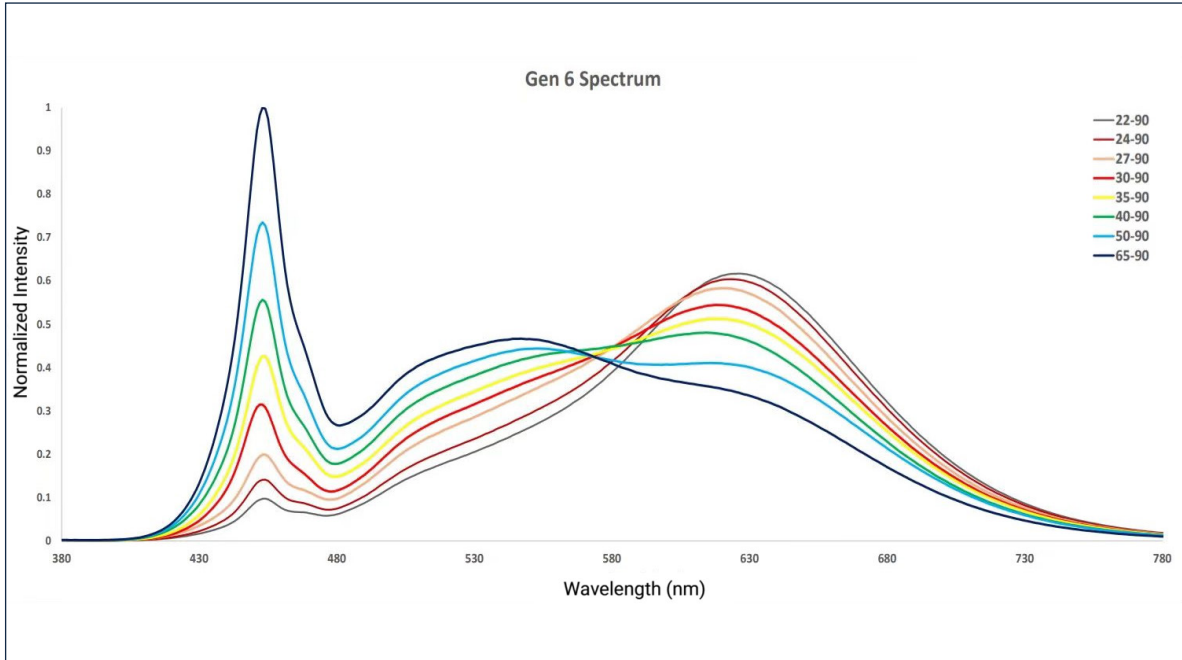

Derating Curve

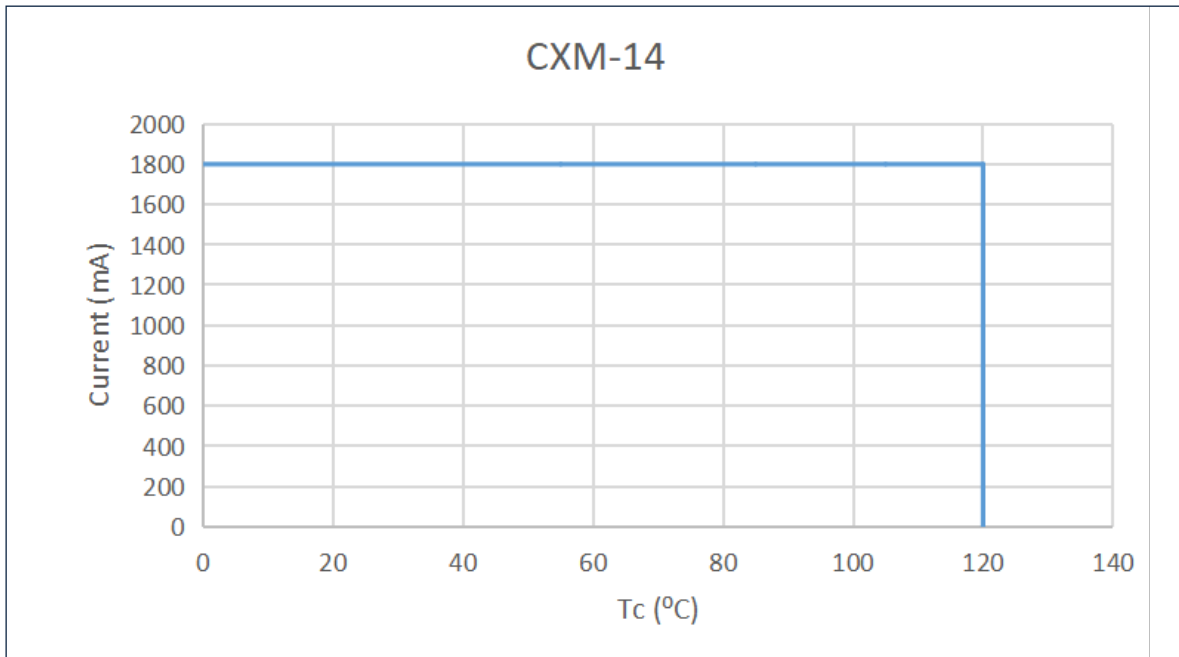



Mechanical Dimensions¹

TC

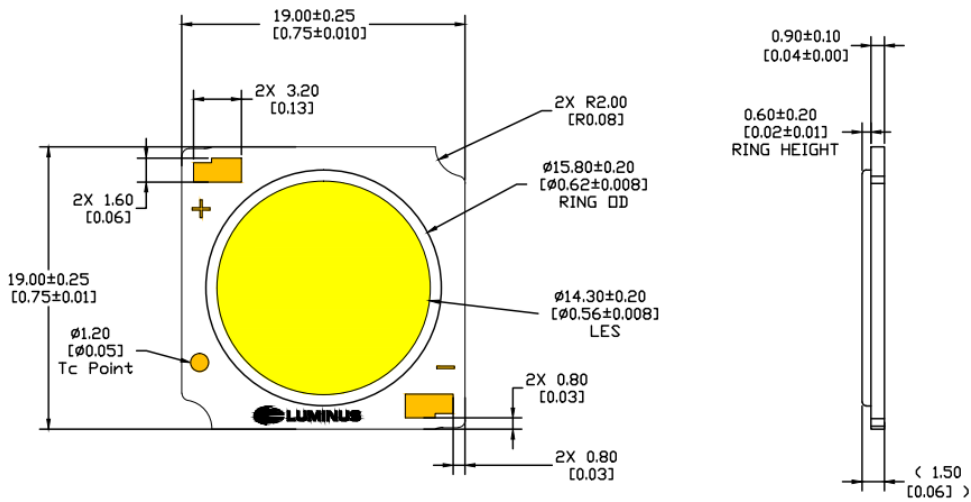

Note:

1. Unless otherwise specified, tolerance is $\pm 0.3\text{mm}$.



Shipping Tray Outline



Packing Configuration:

- 45 pcs per tray and 5 trays are stacked together to be sealed in an anti-static bag.
- The anti-static bag is boxed for easier storage, 225 pcs per box.



Shipping Label

Label on Packaging Box

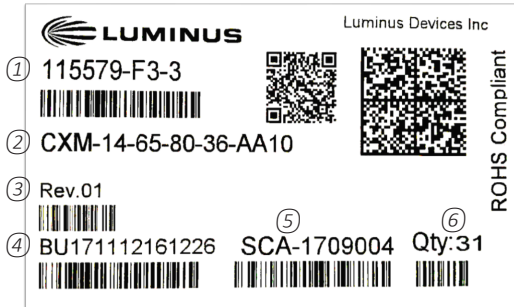

Label model -- for illustration only

Notes:

- ① Manufacturer part number, flux bin and chromaticity bin
- ② Customer part number
- ③ Rev.01 indicates a fully released product
- ④ Box ID
- ⑤ Production ID
- ⑥ Total number of units in a box



Technology Overview

Luminus Chip-on-Board (COB) LED series have consistently delivered the highest lumen performance with the best color quality of any COB supplier. Driving performance enhancements through each generations of COB products has provided Luminus a comprehensive understanding of the lighting market for directional sources positioning Luminus as the COB manufacturer of choice for the most discriminating lighting manufacturers.

Reliability

Designed from the ground up, the Luminus COB LED is one of the most reliable light sources in the world today.

UL and IEC Recognized Compliance

Luminus COB arrays are tested in accordance with ANSI/UL 8750 to ensure safe operation for their intended applications. Further, Luminus maintains IEC-62031 safety ratings on all COB products.

REACH & RoHS Compliance

All LED products manufactured by Luminus are REACH and RoHS compliant and free of hazardous materials, including lead and mercury.

Test Specifications

Every Luminus LED is fully tested to ensure it meets the high quality standards customers have come to expect from Luminus' products.

Traceability

Each Luminus COB LED is marked with a 2D bar code that contains a unique serial number. With this serial number, Luminus has the ability to provide customers with actual test data measurements for a specific LED. In addition, the 2D bar code is linked to manufacturing date codes that enables traceability of production processes and materials.

Testing Temperature

Luminus COB products are measured at temperatures typical for the LED operating in the fixture. Each device is tested at 85°C junction temperature eliminating the need to scale data sheet specifications to real world situations.

Chromaticity Bin Range

Chromaticity binning delivers color consistency for every order. Standard products are delivered with a 3-step MacAdam ellipse. This ensures color performance matching in the application. For the most demanding application, Luminus is one of only a few companies that can provide a 2 SDCM bin distribution. These tightly controlled, small distribution bins provide customers predictable, repeatable colors.



Handling Notes

Luminus products are designed for robust performance in general lighting application. However, care must be taken when handling and assembling the LEDs into their fixtures. To avoid damaging Luminus COBs please follow these guidelines.

The following is an overview of the application notes detailing some of the practices to follow when working with these devices. More detailed information is available on the Luminus web site at www.luminus.com.

General Handling

Devices are made to be lifted or carried with tweezers on two adjacent corners opposite the contact pads. At no time should the devices be handled by or should anything come in contact with the light emitting surface (LES) area. This area includes the yellow colored circular area and the ring surrounding it. There are electrical connections under the LES which if damaged will cause the device to fail. In addition, the ring frame itself should not be used for moving, lifting or carrying the device. Also do not attach any optics or mechanical holders to the ring as it is not capable of handling the mechanical stress.

Storage Condition

Please follow the conditions below.

Before opening	Temperature 5~30°C, relative humidity less than 60%.
After opening	Temperature 5~30°C, relative humidity less than 60%. After opening, LED should be kept in an aluminum moisture proof bag with a moisture absorbent material.
Avoid Corrosive gas	Avoid exposing to air with corrosive gas. If exposed, contact pad solderability may be affected. More detailed information is available on the Luminus Applications Resources web pages.

Static Electricity

Luminus COBs are electronic devices which can be damaged by electrostatic discharge (ESD). Please use appropriate measures to assure the devices do not experience ESD during their handling and or storage. ESD protection guidelines should be used at all time when working with Luminus COBs.

Storage	Luminus products are delivered in ESD shielded bags and should be stored in these bags until used.
Transporting	When transporting the devices from one assembly area to another, ESD shielded carts and carriers should be used.
Assembly	Individuals handling Luminus COBs during assembly should be trained in ESD protection practices. Assemblers should maintain constant conductive contact with a path to ground by means of a wrist strap, ankle straps, mat or other ESD protection system.



Chemical Compatibility

The resin material used to form the LES can get hydrocarbons from the surrounding environment. As a result, certain chemical compounds (H₂SO₄, H₂S, SO₂, NH₃, H₃PO₄, etc.) are not recommended for use with the Luminus products. Use of these compounds can cause damage to the light output of the device and may permanently damage the device. Please refer to the table below for a list of the compounds not recommended for use with the Luminus COB products.

Common Chemicals Know to Adversely Affect Luminus Devices		
Acetates	Ethers	Potassium hydroxide
Acetic acid	Cl, F or Br containing compounds	Siloxanes
Acrylates	Liquid hydrocarbons	Sodium Hydroxide
Aldehydes	Hydrochloric Acid	Sulfur compounds
Aldehydes	Ketones	Sulfuric Acid
Amines	Nitric Acid	Toluene
Benzene	Phosphoric acid	Xylenes
Dienes		

Thermal Interface Material (TIM)

Proper thermal management is critical for successful operation of any LED system. Excess operating temperature can reduce the light output of the device. Excessive heating can cause permanent damage to the device. Proper TIM material is a crucial component for effective heat transfer away from the LED during normal operation. Please refer to www.luminus.com for specific recommendations for TIM solutions.

Please refer to https://download.luminus.com/datasheets/Luminus_APN-002319_Rev_04.pdf for more application note information.



Revision History

Rev	Date	Description of Change
01	04/11/2023	Initial release
02	07/17/2024	Add derating curves
03	08/04/2025	Update new template, update characteristic curves
04	11/18/2025	Update mechanical dimensions

Looking for pricing, stock, or lifecycle information?

Click below to explore more details on WIN SOURCE:

- [View CXM-14-40-80-36-AC40-F5-3 on WIN SOURCE](#)
- [Luminus Devices Inc. Information](#)

Optimize Your Supply Chain with WIN SOURCE Solutions

- ✓ Global Sourcing Solution
- ✓ Obsolete Management
- ✓ Cost Control Management
- ✓ Shortage Management
- ✓ Alternative Solution
- ✓ Excess Inventory Management