



## Reference Specification

Leaded MLCC for Automotive (Powertrain/Safety)  
RCE Series

Product specifications in this catalog are as of Apr. 2025, and are subject to change or obsolescence without notice.  
Please consult the approval sheet before ordering. Please read rating and Cautions first.

## **[CONTENTS]**

- **Scope**
- **Rating**
- **Marking**
- **Part number list**
- **Specification**
- **Packing specification**
- **Taping specification**
- ** CAUTION & NOTICE & NOTE**

## 1. Scope

This product specification is applied to Leaded MLCC RCE series.

## 1. Specific applications:

- Automotive powertrain/safety equipment: Products that can be used for automotive equipment related to running, turning, stopping, safety devices, etc., or equipment whose structure, equipment, and performance are legally required to meet technical standards for safety assurance or environmental protection.
- Automotive infotainment/comfort equipment: Products that can be used for automotive equipment such as car navigation systems and car audio systems that do not directly relate to human life and whose structure, equipment, and performance are not specifically required by law to meet technical standards for safety assurance or environmental protection.
- Medial Equipment [GHTF A/B/C] except for Implant Equipment: Products suitable for use in medical devices designated under the GHTF international classifications as Class A or Class B (the functions of which are not directly involved in protection of human life or property) or in medical devices other than implants designated under the GHTF international classifications as Class C (the malfunctioning of which is considered to pose a comparatively high risk to the human body).

2. Unsuitable Application: Applications listed in "Limitation of applications" in this product specification.  
 WE DISCLAIM ANY LOSS AND DAMAGES ARISING FROM OR IN CONNECTION WITH  
 THE PRODUCTS INCLUDING BUT NOT LIMITED TO THE CASE SUCH LOSS AND DAMAGES  
 CAUSED BY THE UNEXPECTED ACCIDENT,  
 IN EVENT THAT THE PRODUCT IS APPLIED FOR THE PURPOSE WHICH IS SPECIFIED ABOVE  
 AS THE UNSUITABLE APPLICATION FOR THE PRODUCT.

## 2. Rating

## • Part Number Configuration

|        |                             |               |             |                       |                 |            |                          |         |
|--------|-----------------------------|---------------|-------------|-----------------------|-----------------|------------|--------------------------|---------|
| RCE    | 5C                          | 2E            | 223         | J                     | 2               | K1         | H03                      | B       |
| Series | Temperature Characteristics | Rated Voltage | Capacitance | Capacitance Tolerance | Dimension (LxW) | Lead Style | Individual Specification | Package |

## • Temperature Characteristics

| Code | Temp. Char.       | Temp. Range | Temp.coef.     | Standard Temp. | Operating Temp. Range |
|------|-------------------|-------------|----------------|----------------|-----------------------|
| 5C   | C0G<br>(EIA code) | -55~25°C    | 0+30/-72ppm/°C | 25°C           | -55~125°C             |
|      |                   | 25~125°C    | 0+/-30ppm/°C   |                |                       |

## • Rated Voltage

| Code | Rated voltage |
|------|---------------|
| 2E   | DC250V        |
| 2J   | DC630V        |
| 3A   | DC1000V       |

## • Capacitance

The first two digits denote significant figures ; the last digit denotes the multiplier of 10 in pF.

ex.) In case of 223 .

$$22 \times 10^3 = 22000 \text{ pF}$$

## • Capacitance Tolerance

| Code | Capacitance Tolerance |
|------|-----------------------|
| J    | +/-5%                 |

Reference only

- Dimension (LxW)  
Please refer to [ Part number list ].

- Lead Style  
\*Lead wire is "solder coated CP wire".

| Code | Lead Style               | Lead spacing (mm) |
|------|--------------------------|-------------------|
| K1   | Inside crimp type        | 5.0+/-0.8         |
| M1   | Inside crimp taping type | 5.0+0.6/-0.2      |

- Individual Specification  
Murata's control code.  
Please refer to [ Part number list ].





- Package

| Code | Package             |
|------|---------------------|
| A    | Taping type of Ammo |
| B    | Bulk type           |

3. Marking

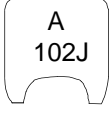
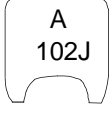
- Temp. char. : Letter code : A (C0G Char.)
- Capacitance : Actual numbers (Less than 100pF)  
3 digit numbers (100pF and over)
- Capacitance tolerance : Code
- Rated voltage : Letter code : 4 (DC250V. Except dimension code : 1)  
Letter code : 7 (DC630V. Except dimension code : 1)  
Letter code : A (DC1000V.)
- Company name code : Abbreviation :  (Except dimension code : 1)

(Ex.)

| Rated voltage / Dimension code | DC250V  | DC630V   | DC1000V   |
|--------------------------------|---|--|---|
| 1                              |  |  | -   |
| 2                              |  |  |  |

## 4. Part number list

- Inside Crimp  
(Lead Style:K\*)

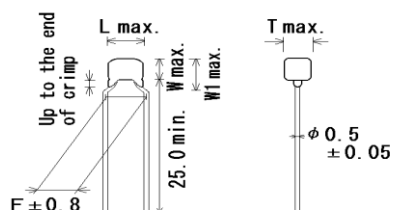

Unit : mm

| Customer Part Number | Murata Part Number | T.C. | DC Rated Volt. (V) | Cap.    | Cap. Tol. | Dimension (mm) |     |     |     |      | Dimension (LxW) Lead Style | Pack qty. (pcs) |
|----------------------|--------------------|------|--------------------|---------|-----------|----------------|-----|-----|-----|------|----------------------------|-----------------|
|                      |                    |      |                    |         |           | L              | W   | W1  | F   | T    |                            |                 |
|                      | RCE5C2E100J1K1H03B | C0G  | 250                | 10pF    | ±5%       | 4.0            | 3.5 | 5.0 | 5.0 | 3.15 | 1K1                        | 500             |
|                      | RCE5C2E120J1K1H03B | C0G  | 250                | 12pF    | ±5%       | 4.0            | 3.5 | 5.0 | 5.0 | 3.15 | 1K1                        | 500             |
|                      | RCE5C2E150J1K1H03B | C0G  | 250                | 15pF    | ±5%       | 4.0            | 3.5 | 5.0 | 5.0 | 3.15 | 1K1                        | 500             |
|                      | RCE5C2E180J1K1H03B | C0G  | 250                | 18pF    | ±5%       | 4.0            | 3.5 | 5.0 | 5.0 | 3.15 | 1K1                        | 500             |
|                      | RCE5C2E220J1K1H03B | C0G  | 250                | 22pF    | ±5%       | 4.0            | 3.5 | 5.0 | 5.0 | 3.15 | 1K1                        | 500             |
|                      | RCE5C2E270J1K1H03B | C0G  | 250                | 27pF    | ±5%       | 4.0            | 3.5 | 5.0 | 5.0 | 3.15 | 1K1                        | 500             |
|                      | RCE5C2E330J1K1H03B | C0G  | 250                | 33pF    | ±5%       | 4.0            | 3.5 | 5.0 | 5.0 | 3.15 | 1K1                        | 500             |
|                      | RCE5C2E390J1K1H03B | C0G  | 250                | 39pF    | ±5%       | 4.0            | 3.5 | 5.0 | 5.0 | 3.15 | 1K1                        | 500             |
|                      | RCE5C2E470J1K1H03B | C0G  | 250                | 47pF    | ±5%       | 4.0            | 3.5 | 5.0 | 5.0 | 3.15 | 1K1                        | 500             |
|                      | RCE5C2E560J1K1H03B | C0G  | 250                | 56pF    | ±5%       | 4.0            | 3.5 | 5.0 | 5.0 | 3.15 | 1K1                        | 500             |
|                      | RCE5C2E680J1K1H03B | C0G  | 250                | 68pF    | ±5%       | 4.0            | 3.5 | 5.0 | 5.0 | 3.15 | 1K1                        | 500             |
|                      | RCE5C2E820J1K1H03B | C0G  | 250                | 82pF    | ±5%       | 4.0            | 3.5 | 5.0 | 5.0 | 3.15 | 1K1                        | 500             |
|                      | RCE5C2E101J1K1H03B | C0G  | 250                | 100pF   | ±5%       | 4.0            | 3.5 | 5.0 | 5.0 | 3.15 | 1K1                        | 500             |
|                      | RCE5C2E121J1K1H03B | C0G  | 250                | 120pF   | ±5%       | 4.0            | 3.5 | 5.0 | 5.0 | 3.15 | 1K1                        | 500             |
|                      | RCE5C2E151J1K1H03B | C0G  | 250                | 150pF   | ±5%       | 4.0            | 3.5 | 5.0 | 5.0 | 3.15 | 1K1                        | 500             |
|                      | RCE5C2E181J1K1H03B | C0G  | 250                | 180pF   | ±5%       | 4.0            | 3.5 | 5.0 | 5.0 | 3.15 | 1K1                        | 500             |
|                      | RCE5C2E221J1K1H03B | C0G  | 250                | 220pF   | ±5%       | 4.0            | 3.5 | 5.0 | 5.0 | 3.15 | 1K1                        | 500             |
|                      | RCE5C2E271J1K1H03B | C0G  | 250                | 270pF   | ±5%       | 4.0            | 3.5 | 5.0 | 5.0 | 3.15 | 1K1                        | 500             |
|                      | RCE5C2E331J1K1H03B | C0G  | 250                | 330pF   | ±5%       | 4.0            | 3.5 | 5.0 | 5.0 | 3.15 | 1K1                        | 500             |
|                      | RCE5C2E391J1K1H03B | C0G  | 250                | 390pF   | ±5%       | 4.0            | 3.5 | 5.0 | 5.0 | 3.15 | 1K1                        | 500             |
|                      | RCE5C2E471J1K1H03B | C0G  | 250                | 470pF   | ±5%       | 4.0            | 3.5 | 5.0 | 5.0 | 3.15 | 1K1                        | 500             |
|                      | RCE5C2E561J1K1H03B | C0G  | 250                | 560pF   | ±5%       | 4.0            | 3.5 | 5.0 | 5.0 | 3.15 | 1K1                        | 500             |
|                      | RCE5C2E681J1K1H03B | C0G  | 250                | 680pF   | ±5%       | 4.0            | 3.5 | 5.0 | 5.0 | 3.15 | 1K1                        | 500             |
|                      | RCE5C2E821J1K1H03B | C0G  | 250                | 820pF   | ±5%       | 4.0            | 3.5 | 5.0 | 5.0 | 3.15 | 1K1                        | 500             |
|                      | RCE5C2E102J1K1H03B | C0G  | 250                | 1000pF  | ±5%       | 4.0            | 3.5 | 5.0 | 5.0 | 3.15 | 1K1                        | 500             |
|                      | RCE5C2E122J1K1H03B | C0G  | 250                | 1200pF  | ±5%       | 4.0            | 3.5 | 5.0 | 5.0 | 3.15 | 1K1                        | 500             |
|                      | RCE5C2E152J1K1H03B | C0G  | 250                | 1500pF  | ±5%       | 4.0            | 3.5 | 5.0 | 5.0 | 3.15 | 1K1                        | 500             |
|                      | RCE5C2E182J1K1H03B | C0G  | 250                | 1800pF  | ±5%       | 4.0            | 3.5 | 5.0 | 5.0 | 3.15 | 1K1                        | 500             |
|                      | RCE5C2E222J1K1H03B | C0G  | 250                | 2200pF  | ±5%       | 4.0            | 3.5 | 5.0 | 5.0 | 3.15 | 1K1                        | 500             |
|                      | RCE5C2E272J1K1H03B | C0G  | 250                | 2700pF  | ±5%       | 4.0            | 3.5 | 5.0 | 5.0 | 3.15 | 1K1                        | 500             |
|                      | RCE5C2E332J1K1H03B | C0G  | 250                | 3300pF  | ±5%       | 4.0            | 3.5 | 5.0 | 5.0 | 3.15 | 1K1                        | 500             |
|                      | RCE5C2E392J1K1H03B | C0G  | 250                | 3900pF  | ±5%       | 4.0            | 3.5 | 5.0 | 5.0 | 3.15 | 1K1                        | 500             |
|                      | RCE5C2E472J1K1H03B | C0G  | 250                | 4700pF  | ±5%       | 4.0            | 3.5 | 5.0 | 5.0 | 3.15 | 1K1                        | 500             |
|                      | RCE5C2E562J1K1H03B | C0G  | 250                | 5600pF  | ±5%       | 4.0            | 3.5 | 5.0 | 5.0 | 3.15 | 1K1                        | 500             |
|                      | RCE5C2E682J1K1H03B | C0G  | 250                | 6800pF  | ±5%       | 4.0            | 3.5 | 5.0 | 5.0 | 3.15 | 1K1                        | 500             |
|                      | RCE5C2E822J1K1H03B | C0G  | 250                | 8200pF  | ±5%       | 4.0            | 3.5 | 5.0 | 5.0 | 3.15 | 1K1                        | 500             |
|                      | RCE5C2E103J1K1H03B | C0G  | 250                | 10000pF | ±5%       | 4.0            | 3.5 | 5.0 | 5.0 | 3.15 | 1K1                        | 500             |
|                      | RCE5C2E123J2K1H03B | C0G  | 250                | 12000pF | ±5%       | 5.5            | 4.0 | 6.0 | 5.0 | 3.15 | 2K1                        | 500             |
|                      | RCE5C2E153J2K1H03B | C0G  | 250                | 15000pF | ±5%       | 5.5            | 4.0 | 6.0 | 5.0 | 3.15 | 2K1                        | 500             |
|                      | RCE5C2E183J2K1H03B | C0G  | 250                | 18000pF | ±5%       | 5.5            | 4.0 | 6.0 | 5.0 | 3.15 | 2K1                        | 500             |

- Inside Crimp  
(Lead Style:K\*)

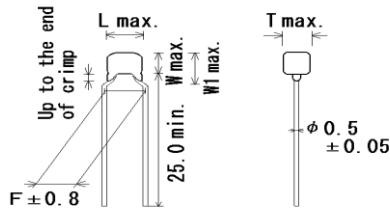

Unit : mm

| Customer Part Number | Murata Part Number | T.C. | DC Rated Volt. (V) | Cap.    | Cap. Tol. | Dimension (mm) |     |     |     |      | Dimension (LxW) Lead Style | Pack qty. (pcs) |
|----------------------|--------------------|------|--------------------|---------|-----------|----------------|-----|-----|-----|------|----------------------------|-----------------|
|                      |                    |      |                    |         |           | L              | W   | W1  | F   | T    |                            |                 |
|                      | RCE5C2E223J2K1H03B | C0G  | 250                | 22000pF | ±5%       | 5.5            | 4.0 | 6.0 | 5.0 | 3.15 | 2K1                        | 500             |
|                      | RCE5C2J100J1K1H03B | C0G  | 630                | 10pF    | ±5%       | 4.0            | 3.5 | 5.0 | 5.0 | 3.15 | 1K1                        | 500             |
|                      | RCE5C2J120J1K1H03B | C0G  | 630                | 12pF    | ±5%       | 4.0            | 3.5 | 5.0 | 5.0 | 3.15 | 1K1                        | 500             |
|                      | RCE5C2J150J1K1H03B | C0G  | 630                | 15pF    | ±5%       | 4.0            | 3.5 | 5.0 | 5.0 | 3.15 | 1K1                        | 500             |
|                      | RCE5C2J180J1K1H03B | C0G  | 630                | 18pF    | ±5%       | 4.0            | 3.5 | 5.0 | 5.0 | 3.15 | 1K1                        | 500             |
|                      | RCE5C2J220J1K1H03B | C0G  | 630                | 22pF    | ±5%       | 4.0            | 3.5 | 5.0 | 5.0 | 3.15 | 1K1                        | 500             |
|                      | RCE5C2J270J1K1H03B | C0G  | 630                | 27pF    | ±5%       | 4.0            | 3.5 | 5.0 | 5.0 | 3.15 | 1K1                        | 500             |
|                      | RCE5C2J330J1K1H03B | C0G  | 630                | 33pF    | ±5%       | 4.0            | 3.5 | 5.0 | 5.0 | 3.15 | 1K1                        | 500             |
|                      | RCE5C2J390J1K1H03B | C0G  | 630                | 39pF    | ±5%       | 4.0            | 3.5 | 5.0 | 5.0 | 3.15 | 1K1                        | 500             |
|                      | RCE5C2J470J1K1H03B | C0G  | 630                | 47pF    | ±5%       | 4.0            | 3.5 | 5.0 | 5.0 | 3.15 | 1K1                        | 500             |
|                      | RCE5C2J560J1K1H03B | C0G  | 630                | 56pF    | ±5%       | 4.0            | 3.5 | 5.0 | 5.0 | 3.15 | 1K1                        | 500             |
|                      | RCE5C2J680J1K1H03B | C0G  | 630                | 68pF    | ±5%       | 4.0            | 3.5 | 5.0 | 5.0 | 3.15 | 1K1                        | 500             |
|                      | RCE5C2J820J1K1H03B | C0G  | 630                | 82pF    | ±5%       | 4.0            | 3.5 | 5.0 | 5.0 | 3.15 | 1K1                        | 500             |
|                      | RCE5C2J101J1K1H03B | C0G  | 630                | 100pF   | ±5%       | 4.0            | 3.5 | 5.0 | 5.0 | 3.15 | 1K1                        | 500             |
|                      | RCE5C2J121J1K1H03B | C0G  | 630                | 120pF   | ±5%       | 4.0            | 3.5 | 5.0 | 5.0 | 3.15 | 1K1                        | 500             |
|                      | RCE5C2J151J1K1H03B | C0G  | 630                | 150pF   | ±5%       | 4.0            | 3.5 | 5.0 | 5.0 | 3.15 | 1K1                        | 500             |
|                      | RCE5C2J181J1K1H03B | C0G  | 630                | 180pF   | ±5%       | 4.0            | 3.5 | 5.0 | 5.0 | 3.15 | 1K1                        | 500             |
|                      | RCE5C2J221J1K1H03B | C0G  | 630                | 220pF   | ±5%       | 4.0            | 3.5 | 5.0 | 5.0 | 3.15 | 1K1                        | 500             |
|                      | RCE5C2J271J1K1H03B | C0G  | 630                | 270pF   | ±5%       | 4.0            | 3.5 | 5.0 | 5.0 | 3.15 | 1K1                        | 500             |
|                      | RCE5C2J331J1K1H03B | C0G  | 630                | 330pF   | ±5%       | 4.0            | 3.5 | 5.0 | 5.0 | 3.15 | 1K1                        | 500             |
|                      | RCE5C2J391J1K1H03B | C0G  | 630                | 390pF   | ±5%       | 4.0            | 3.5 | 5.0 | 5.0 | 3.15 | 1K1                        | 500             |
|                      | RCE5C2J471J1K1H03B | C0G  | 630                | 470pF   | ±5%       | 4.0            | 3.5 | 5.0 | 5.0 | 3.15 | 1K1                        | 500             |
|                      | RCE5C2J561J1K1H03B | C0G  | 630                | 560pF   | ±5%       | 4.0            | 3.5 | 5.0 | 5.0 | 3.15 | 1K1                        | 500             |
|                      | RCE5C2J681J1K1H03B | C0G  | 630                | 680pF   | ±5%       | 4.0            | 3.5 | 5.0 | 5.0 | 3.15 | 1K1                        | 500             |
|                      | RCE5C2J821J1K1H03B | C0G  | 630                | 820pF   | ±5%       | 4.0            | 3.5 | 5.0 | 5.0 | 3.15 | 1K1                        | 500             |
|                      | RCE5C2J102J1K1H03B | C0G  | 630                | 1000pF  | ±5%       | 4.0            | 3.5 | 5.0 | 5.0 | 3.15 | 1K1                        | 500             |
|                      | RCE5C2J122J1K1H03B | C0G  | 630                | 1200pF  | ±5%       | 4.0            | 3.5 | 5.0 | 5.0 | 3.15 | 1K1                        | 500             |
|                      | RCE5C2J152J1K1H03B | C0G  | 630                | 1500pF  | ±5%       | 4.0            | 3.5 | 5.0 | 5.0 | 3.15 | 1K1                        | 500             |
|                      | RCE5C2J182J1K1H03B | C0G  | 630                | 1800pF  | ±5%       | 4.0            | 3.5 | 5.0 | 5.0 | 3.15 | 1K1                        | 500             |
|                      | RCE5C2J222J1K1H03B | C0G  | 630                | 2200pF  | ±5%       | 4.0            | 3.5 | 5.0 | 5.0 | 3.15 | 1K1                        | 500             |
|                      | RCE5C2J272J2K1H03B | C0G  | 630                | 2700pF  | ±5%       | 5.5            | 4.0 | 6.0 | 5.0 | 3.15 | 2K1                        | 500             |
|                      | RCE5C2J332J2K1H03B | C0G  | 630                | 3300pF  | ±5%       | 5.5            | 4.0 | 6.0 | 5.0 | 3.15 | 2K1                        | 500             |
|                      | RCE5C2J392J2K1H03B | C0G  | 630                | 3900pF  | ±5%       | 5.5            | 4.0 | 6.0 | 5.0 | 3.15 | 2K1                        | 500             |
|                      | RCE5C2J472J2K1H03B | C0G  | 630                | 4700pF  | ±5%       | 5.5            | 4.0 | 6.0 | 5.0 | 3.15 | 2K1                        | 500             |
|                      | RCE5C3A100J2K1H03B | C0G  | 1000               | 10pF    | ±5%       | 5.5            | 4.0 | 6.0 | 5.0 | 3.15 | 2K1                        | 500             |
|                      | RCE5C3A120J2K1H03B | C0G  | 1000               | 12pF    | ±5%       | 5.5            | 4.0 | 6.0 | 5.0 | 3.15 | 2K1                        | 500             |
|                      | RCE5C3A150J2K1H03B | C0G  | 1000               | 15pF    | ±5%       | 5.5            | 4.0 | 6.0 | 5.0 | 3.15 | 2K1                        | 500             |
|                      | RCE5C3A180J2K1H03B | C0G  | 1000               | 18pF    | ±5%       | 5.5            | 4.0 | 6.0 | 5.0 | 3.15 | 2K1                        | 500             |
|                      | RCE5C3A220J2K1H03B | C0G  | 1000               | 22pF    | ±5%       | 5.5            | 4.0 | 6.0 | 5.0 | 3.15 | 2K1                        | 500             |
|                      | RCE5C3A270J2K1H03B | C0G  | 1000               | 27pF    | ±5%       | 5.5            | 4.0 | 6.0 | 5.0 | 3.15 | 2K1                        | 500             |

- Inside Crimp  
(Lead Style:K\*)

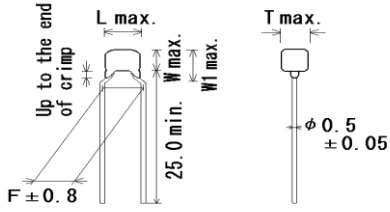

Unit : mm

| Customer Part Number | Murata Part Number | T.C. | DC Rated Volt. (V) | Cap.   | Cap. Tol. | Dimension (mm) |     |     |     |      | Dimension (LxW) Lead Style | Pack qty. (pcs) |
|----------------------|--------------------|------|--------------------|--------|-----------|----------------|-----|-----|-----|------|----------------------------|-----------------|
|                      |                    |      |                    |        |           | L              | W   | W1  | F   | T    |                            |                 |
|                      | RCE5C3A330J2K1H03B | C0G  | 1000               | 33pF   | ±5%       | 5.5            | 4.0 | 6.0 | 5.0 | 3.15 | 2K1                        | 500             |
|                      | RCE5C3A390J2K1H03B | C0G  | 1000               | 39pF   | ±5%       | 5.5            | 4.0 | 6.0 | 5.0 | 3.15 | 2K1                        | 500             |
|                      | RCE5C3A470J2K1H03B | C0G  | 1000               | 47pF   | ±5%       | 5.5            | 4.0 | 6.0 | 5.0 | 3.15 | 2K1                        | 500             |
|                      | RCE5C3A560J2K1H03B | C0G  | 1000               | 56pF   | ±5%       | 5.5            | 4.0 | 6.0 | 5.0 | 3.15 | 2K1                        | 500             |
|                      | RCE5C3A680J2K1H03B | C0G  | 1000               | 68pF   | ±5%       | 5.5            | 4.0 | 6.0 | 5.0 | 3.15 | 2K1                        | 500             |
|                      | RCE5C3A820J2K1H03B | C0G  | 1000               | 82pF   | ±5%       | 5.5            | 4.0 | 6.0 | 5.0 | 3.15 | 2K1                        | 500             |
|                      | RCE5C3A101J2K1H03B | C0G  | 1000               | 100pF  | ±5%       | 5.5            | 4.0 | 6.0 | 5.0 | 3.15 | 2K1                        | 500             |
|                      | RCE5C3A121J2K1H03B | C0G  | 1000               | 120pF  | ±5%       | 5.5            | 4.0 | 6.0 | 5.0 | 3.15 | 2K1                        | 500             |
|                      | RCE5C3A151J2K1H03B | C0G  | 1000               | 150pF  | ±5%       | 5.5            | 4.0 | 6.0 | 5.0 | 3.15 | 2K1                        | 500             |
|                      | RCE5C3A181J2K1H03B | C0G  | 1000               | 180pF  | ±5%       | 5.5            | 4.0 | 6.0 | 5.0 | 3.15 | 2K1                        | 500             |
|                      | RCE5C3A221J2K1H03B | C0G  | 1000               | 220pF  | ±5%       | 5.5            | 4.0 | 6.0 | 5.0 | 3.15 | 2K1                        | 500             |
|                      | RCE5C3A271J2K1H03B | C0G  | 1000               | 270pF  | ±5%       | 5.5            | 4.0 | 6.0 | 5.0 | 3.15 | 2K1                        | 500             |
|                      | RCE5C3A331J2K1H03B | C0G  | 1000               | 330pF  | ±5%       | 5.5            | 4.0 | 6.0 | 5.0 | 3.15 | 2K1                        | 500             |
|                      | RCE5C3A391J2K1H03B | C0G  | 1000               | 390pF  | ±5%       | 5.5            | 4.0 | 6.0 | 5.0 | 3.15 | 2K1                        | 500             |
|                      | RCE5C3A471J2K1H03B | C0G  | 1000               | 470pF  | ±5%       | 5.5            | 4.0 | 6.0 | 5.0 | 3.15 | 2K1                        | 500             |
|                      | RCE5C3A561J2K1H03B | C0G  | 1000               | 560pF  | ±5%       | 5.5            | 4.0 | 6.0 | 5.0 | 3.15 | 2K1                        | 500             |
|                      | RCE5C3A681J2K1H03B | C0G  | 1000               | 680pF  | ±5%       | 5.5            | 4.0 | 6.0 | 5.0 | 3.15 | 2K1                        | 500             |
|                      | RCE5C3A821J2K1H03B | C0G  | 1000               | 820pF  | ±5%       | 5.5            | 4.0 | 6.0 | 5.0 | 3.15 | 2K1                        | 500             |
|                      | RCE5C3A102J2K1H03B | C0G  | 1000               | 1000pF | ±5%       | 5.5            | 4.0 | 6.0 | 5.0 | 3.15 | 2K1                        | 500             |

• Inside Crimp Taping  
(Lead Style: M\*)

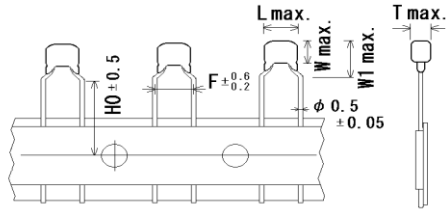

Unit : mm

| Customer Part Number | Murata Part Number | T.C. | DC Rated Volt. (V) | Cap.    | Cap. Tol. | Dimension (mm) |     |     |     |      |      | Dimension (LxW) Lead Style | Pack qty. (pcs) |
|----------------------|--------------------|------|--------------------|---------|-----------|----------------|-----|-----|-----|------|------|----------------------------|-----------------|
|                      |                    |      |                    |         |           | L              | W   | W1  | F   | T    | H/H0 |                            |                 |
|                      | RCE5C2E100J1M1H03A | C0G  | 250                | 10pF    | ±5%       | 4.0            | 3.5 | 5.0 | 5.0 | 3.15 | 16.0 | 1M1                        | 2000            |
|                      | RCE5C2E120J1M1H03A | C0G  | 250                | 12pF    | ±5%       | 4.0            | 3.5 | 5.0 | 5.0 | 3.15 | 16.0 | 1M1                        | 2000            |
|                      | RCE5C2E150J1M1H03A | C0G  | 250                | 15pF    | ±5%       | 4.0            | 3.5 | 5.0 | 5.0 | 3.15 | 16.0 | 1M1                        | 2000            |
|                      | RCE5C2E180J1M1H03A | C0G  | 250                | 18pF    | ±5%       | 4.0            | 3.5 | 5.0 | 5.0 | 3.15 | 16.0 | 1M1                        | 2000            |
|                      | RCE5C2E220J1M1H03A | C0G  | 250                | 22pF    | ±5%       | 4.0            | 3.5 | 5.0 | 5.0 | 3.15 | 16.0 | 1M1                        | 2000            |
|                      | RCE5C2E270J1M1H03A | C0G  | 250                | 27pF    | ±5%       | 4.0            | 3.5 | 5.0 | 5.0 | 3.15 | 16.0 | 1M1                        | 2000            |
|                      | RCE5C2E330J1M1H03A | C0G  | 250                | 33pF    | ±5%       | 4.0            | 3.5 | 5.0 | 5.0 | 3.15 | 16.0 | 1M1                        | 2000            |
|                      | RCE5C2E390J1M1H03A | C0G  | 250                | 39pF    | ±5%       | 4.0            | 3.5 | 5.0 | 5.0 | 3.15 | 16.0 | 1M1                        | 2000            |
|                      | RCE5C2E470J1M1H03A | C0G  | 250                | 47pF    | ±5%       | 4.0            | 3.5 | 5.0 | 5.0 | 3.15 | 16.0 | 1M1                        | 2000            |
|                      | RCE5C2E560J1M1H03A | C0G  | 250                | 56pF    | ±5%       | 4.0            | 3.5 | 5.0 | 5.0 | 3.15 | 16.0 | 1M1                        | 2000            |
|                      | RCE5C2E680J1M1H03A | C0G  | 250                | 68pF    | ±5%       | 4.0            | 3.5 | 5.0 | 5.0 | 3.15 | 16.0 | 1M1                        | 2000            |
|                      | RCE5C2E820J1M1H03A | C0G  | 250                | 82pF    | ±5%       | 4.0            | 3.5 | 5.0 | 5.0 | 3.15 | 16.0 | 1M1                        | 2000            |
|                      | RCE5C2E101J1M1H03A | C0G  | 250                | 100pF   | ±5%       | 4.0            | 3.5 | 5.0 | 5.0 | 3.15 | 16.0 | 1M1                        | 2000            |
|                      | RCE5C2E121J1M1H03A | C0G  | 250                | 120pF   | ±5%       | 4.0            | 3.5 | 5.0 | 5.0 | 3.15 | 16.0 | 1M1                        | 2000            |
|                      | RCE5C2E151J1M1H03A | C0G  | 250                | 150pF   | ±5%       | 4.0            | 3.5 | 5.0 | 5.0 | 3.15 | 16.0 | 1M1                        | 2000            |
|                      | RCE5C2E181J1M1H03A | C0G  | 250                | 180pF   | ±5%       | 4.0            | 3.5 | 5.0 | 5.0 | 3.15 | 16.0 | 1M1                        | 2000            |
|                      | RCE5C2E221J1M1H03A | C0G  | 250                | 220pF   | ±5%       | 4.0            | 3.5 | 5.0 | 5.0 | 3.15 | 16.0 | 1M1                        | 2000            |
|                      | RCE5C2E271J1M1H03A | C0G  | 250                | 270pF   | ±5%       | 4.0            | 3.5 | 5.0 | 5.0 | 3.15 | 16.0 | 1M1                        | 2000            |
|                      | RCE5C2E331J1M1H03A | C0G  | 250                | 330pF   | ±5%       | 4.0            | 3.5 | 5.0 | 5.0 | 3.15 | 16.0 | 1M1                        | 2000            |
|                      | RCE5C2E391J1M1H03A | C0G  | 250                | 390pF   | ±5%       | 4.0            | 3.5 | 5.0 | 5.0 | 3.15 | 16.0 | 1M1                        | 2000            |
|                      | RCE5C2E471J1M1H03A | C0G  | 250                | 470pF   | ±5%       | 4.0            | 3.5 | 5.0 | 5.0 | 3.15 | 16.0 | 1M1                        | 2000            |
|                      | RCE5C2E561J1M1H03A | C0G  | 250                | 560pF   | ±5%       | 4.0            | 3.5 | 5.0 | 5.0 | 3.15 | 16.0 | 1M1                        | 2000            |
|                      | RCE5C2E681J1M1H03A | C0G  | 250                | 680pF   | ±5%       | 4.0            | 3.5 | 5.0 | 5.0 | 3.15 | 16.0 | 1M1                        | 2000            |
|                      | RCE5C2E821J1M1H03A | C0G  | 250                | 820pF   | ±5%       | 4.0            | 3.5 | 5.0 | 5.0 | 3.15 | 16.0 | 1M1                        | 2000            |
|                      | RCE5C2E102J1M1H03A | C0G  | 250                | 1000pF  | ±5%       | 4.0            | 3.5 | 5.0 | 5.0 | 3.15 | 16.0 | 1M1                        | 2000            |
|                      | RCE5C2E122J1M1H03A | C0G  | 250                | 1200pF  | ±5%       | 4.0            | 3.5 | 5.0 | 5.0 | 3.15 | 16.0 | 1M1                        | 2000            |
|                      | RCE5C2E152J1M1H03A | C0G  | 250                | 1500pF  | ±5%       | 4.0            | 3.5 | 5.0 | 5.0 | 3.15 | 16.0 | 1M1                        | 2000            |
|                      | RCE5C2E182J1M1H03A | C0G  | 250                | 1800pF  | ±5%       | 4.0            | 3.5 | 5.0 | 5.0 | 3.15 | 16.0 | 1M1                        | 2000            |
|                      | RCE5C2E222J1M1H03A | C0G  | 250                | 2200pF  | ±5%       | 4.0            | 3.5 | 5.0 | 5.0 | 3.15 | 16.0 | 1M1                        | 2000            |
|                      | RCE5C2E272J1M1H03A | C0G  | 250                | 2700pF  | ±5%       | 4.0            | 3.5 | 5.0 | 5.0 | 3.15 | 16.0 | 1M1                        | 2000            |
|                      | RCE5C2E332J1M1H03A | C0G  | 250                | 3300pF  | ±5%       | 4.0            | 3.5 | 5.0 | 5.0 | 3.15 | 16.0 | 1M1                        | 2000            |
|                      | RCE5C2E392J1M1H03A | C0G  | 250                | 3900pF  | ±5%       | 4.0            | 3.5 | 5.0 | 5.0 | 3.15 | 16.0 | 1M1                        | 2000            |
|                      | RCE5C2E472J1M1H03A | C0G  | 250                | 4700pF  | ±5%       | 4.0            | 3.5 | 5.0 | 5.0 | 3.15 | 16.0 | 1M1                        | 2000            |
|                      | RCE5C2E562J1M1H03A | C0G  | 250                | 5600pF  | ±5%       | 4.0            | 3.5 | 5.0 | 5.0 | 3.15 | 16.0 | 1M1                        | 2000            |
|                      | RCE5C2E682J1M1H03A | C0G  | 250                | 6800pF  | ±5%       | 4.0            | 3.5 | 5.0 | 5.0 | 3.15 | 16.0 | 1M1                        | 2000            |
|                      | RCE5C2E822J1M1H03A | C0G  | 250                | 8200pF  | ±5%       | 4.0            | 3.5 | 5.0 | 5.0 | 3.15 | 16.0 | 1M1                        | 2000            |
|                      | RCE5C2E103J1M1H03A | C0G  | 250                | 10000pF | ±5%       | 4.0            | 3.5 | 5.0 | 5.0 | 3.15 | 16.0 | 1M1                        | 2000            |
|                      | RCE5C2E123J2M1H03A | C0G  | 250                | 12000pF | ±5%       | 5.5            | 4.0 | 6.0 | 5.0 | 3.15 | 16.0 | 2M1                        | 2000            |
|                      | RCE5C2E153J2M1H03A | C0G  | 250                | 15000pF | ±5%       | 5.5            | 4.0 | 6.0 | 5.0 | 3.15 | 16.0 | 2M1                        | 2000            |
|                      | RCE5C2E183J2M1H03A | C0G  | 250                | 18000pF | ±5%       | 5.5            | 4.0 | 6.0 | 5.0 | 3.15 | 16.0 | 2M1                        | 2000            |

• Inside Crimp Taping  
(Lead Style: M\*)

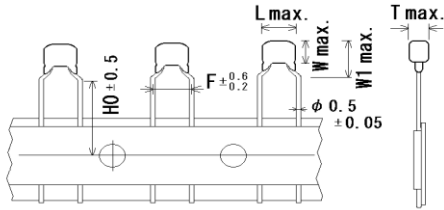

Unit : mm

| Customer Part Number | Murata Part Number | T.C. | DC Rated Volt. (V) | Cap.    | Cap. Tol. | Dimension (mm) |     |     |     |      |      | Dimension (LxW) Lead Style | Pack qty. (pcs) |
|----------------------|--------------------|------|--------------------|---------|-----------|----------------|-----|-----|-----|------|------|----------------------------|-----------------|
|                      |                    |      |                    |         |           | L              | W   | W1  | F   | T    | H/H0 |                            |                 |
|                      | RCE5C2E223J2M1H03A | C0G  | 250                | 22000pF | ±5%       | 5.5            | 4.0 | 6.0 | 5.0 | 3.15 | 16.0 | 2M1                        | 2000            |
|                      | RCE5C2J100J1M1H03A | C0G  | 630                | 10pF    | ±5%       | 4.0            | 3.5 | 5.0 | 5.0 | 3.15 | 16.0 | 1M1                        | 2000            |
|                      | RCE5C2J120J1M1H03A | C0G  | 630                | 12pF    | ±5%       | 4.0            | 3.5 | 5.0 | 5.0 | 3.15 | 16.0 | 1M1                        | 2000            |
|                      | RCE5C2J150J1M1H03A | C0G  | 630                | 15pF    | ±5%       | 4.0            | 3.5 | 5.0 | 5.0 | 3.15 | 16.0 | 1M1                        | 2000            |
|                      | RCE5C2J180J1M1H03A | C0G  | 630                | 18pF    | ±5%       | 4.0            | 3.5 | 5.0 | 5.0 | 3.15 | 16.0 | 1M1                        | 2000            |
|                      | RCE5C2J220J1M1H03A | C0G  | 630                | 22pF    | ±5%       | 4.0            | 3.5 | 5.0 | 5.0 | 3.15 | 16.0 | 1M1                        | 2000            |
|                      | RCE5C2J270J1M1H03A | C0G  | 630                | 27pF    | ±5%       | 4.0            | 3.5 | 5.0 | 5.0 | 3.15 | 16.0 | 1M1                        | 2000            |
|                      | RCE5C2J330J1M1H03A | C0G  | 630                | 33pF    | ±5%       | 4.0            | 3.5 | 5.0 | 5.0 | 3.15 | 16.0 | 1M1                        | 2000            |
|                      | RCE5C2J390J1M1H03A | C0G  | 630                | 39pF    | ±5%       | 4.0            | 3.5 | 5.0 | 5.0 | 3.15 | 16.0 | 1M1                        | 2000            |
|                      | RCE5C2J470J1M1H03A | C0G  | 630                | 47pF    | ±5%       | 4.0            | 3.5 | 5.0 | 5.0 | 3.15 | 16.0 | 1M1                        | 2000            |
|                      | RCE5C2J560J1M1H03A | C0G  | 630                | 56pF    | ±5%       | 4.0            | 3.5 | 5.0 | 5.0 | 3.15 | 16.0 | 1M1                        | 2000            |
|                      | RCE5C2J680J1M1H03A | C0G  | 630                | 68pF    | ±5%       | 4.0            | 3.5 | 5.0 | 5.0 | 3.15 | 16.0 | 1M1                        | 2000            |
|                      | RCE5C2J820J1M1H03A | C0G  | 630                | 82pF    | ±5%       | 4.0            | 3.5 | 5.0 | 5.0 | 3.15 | 16.0 | 1M1                        | 2000            |
|                      | RCE5C2J101J1M1H03A | C0G  | 630                | 100pF   | ±5%       | 4.0            | 3.5 | 5.0 | 5.0 | 3.15 | 16.0 | 1M1                        | 2000            |
|                      | RCE5C2J121J1M1H03A | C0G  | 630                | 120pF   | ±5%       | 4.0            | 3.5 | 5.0 | 5.0 | 3.15 | 16.0 | 1M1                        | 2000            |
|                      | RCE5C2J151J1M1H03A | C0G  | 630                | 150pF   | ±5%       | 4.0            | 3.5 | 5.0 | 5.0 | 3.15 | 16.0 | 1M1                        | 2000            |
|                      | RCE5C2J181J1M1H03A | C0G  | 630                | 180pF   | ±5%       | 4.0            | 3.5 | 5.0 | 5.0 | 3.15 | 16.0 | 1M1                        | 2000            |
|                      | RCE5C2J221J1M1H03A | C0G  | 630                | 220pF   | ±5%       | 4.0            | 3.5 | 5.0 | 5.0 | 3.15 | 16.0 | 1M1                        | 2000            |
|                      | RCE5C2J271J1M1H03A | C0G  | 630                | 270pF   | ±5%       | 4.0            | 3.5 | 5.0 | 5.0 | 3.15 | 16.0 | 1M1                        | 2000            |
|                      | RCE5C2J331J1M1H03A | C0G  | 630                | 330pF   | ±5%       | 4.0            | 3.5 | 5.0 | 5.0 | 3.15 | 16.0 | 1M1                        | 2000            |
|                      | RCE5C2J391J1M1H03A | C0G  | 630                | 390pF   | ±5%       | 4.0            | 3.5 | 5.0 | 5.0 | 3.15 | 16.0 | 1M1                        | 2000            |
|                      | RCE5C2J471J1M1H03A | C0G  | 630                | 470pF   | ±5%       | 4.0            | 3.5 | 5.0 | 5.0 | 3.15 | 16.0 | 1M1                        | 2000            |
|                      | RCE5C2J561J1M1H03A | C0G  | 630                | 560pF   | ±5%       | 4.0            | 3.5 | 5.0 | 5.0 | 3.15 | 16.0 | 1M1                        | 2000            |
|                      | RCE5C2J681J1M1H03A | C0G  | 630                | 680pF   | ±5%       | 4.0            | 3.5 | 5.0 | 5.0 | 3.15 | 16.0 | 1M1                        | 2000            |
|                      | RCE5C2J821J1M1H03A | C0G  | 630                | 820pF   | ±5%       | 4.0            | 3.5 | 5.0 | 5.0 | 3.15 | 16.0 | 1M1                        | 2000            |
|                      | RCE5C2J102J1M1H03A | C0G  | 630                | 1000pF  | ±5%       | 4.0            | 3.5 | 5.0 | 5.0 | 3.15 | 16.0 | 1M1                        | 2000            |
|                      | RCE5C2J122J1M1H03A | C0G  | 630                | 1200pF  | ±5%       | 4.0            | 3.5 | 5.0 | 5.0 | 3.15 | 16.0 | 1M1                        | 2000            |
|                      | RCE5C2J152J1M1H03A | C0G  | 630                | 1500pF  | ±5%       | 4.0            | 3.5 | 5.0 | 5.0 | 3.15 | 16.0 | 1M1                        | 2000            |
|                      | RCE5C2J182J1M1H03A | C0G  | 630                | 1800pF  | ±5%       | 4.0            | 3.5 | 5.0 | 5.0 | 3.15 | 16.0 | 1M1                        | 2000            |
|                      | RCE5C2J222J1M1H03A | C0G  | 630                | 2200pF  | ±5%       | 4.0            | 3.5 | 5.0 | 5.0 | 3.15 | 16.0 | 1M1                        | 2000            |
|                      | RCE5C2J272J2M1H03A | C0G  | 630                | 2700pF  | ±5%       | 5.5            | 4.0 | 6.0 | 5.0 | 3.15 | 16.0 | 2M1                        | 2000            |
|                      | RCE5C2J332J2M1H03A | C0G  | 630                | 3300pF  | ±5%       | 5.5            | 4.0 | 6.0 | 5.0 | 3.15 | 16.0 | 2M1                        | 2000            |
|                      | RCE5C2J392J2M1H03A | C0G  | 630                | 3900pF  | ±5%       | 5.5            | 4.0 | 6.0 | 5.0 | 3.15 | 16.0 | 2M1                        | 2000            |
|                      | RCE5C2J472J2M1H03A | C0G  | 630                | 4700pF  | ±5%       | 5.5            | 4.0 | 6.0 | 5.0 | 3.15 | 16.0 | 2M1                        | 2000            |
|                      | RCE5C3A100J2M1H03A | C0G  | 1000               | 10pF    | ±5%       | 5.5            | 4.0 | 6.0 | 5.0 | 3.15 | 16.0 | 2M1                        | 2000            |
|                      | RCE5C3A120J2M1H03A | C0G  | 1000               | 12pF    | ±5%       | 5.5            | 4.0 | 6.0 | 5.0 | 3.15 | 16.0 | 2M1                        | 2000            |
|                      | RCE5C3A150J2M1H03A | C0G  | 1000               | 15pF    | ±5%       | 5.5            | 4.0 | 6.0 | 5.0 | 3.15 | 16.0 | 2M1                        | 2000            |
|                      | RCE5C3A180J2M1H03A | C0G  | 1000               | 18pF    | ±5%       | 5.5            | 4.0 | 6.0 | 5.0 | 3.15 | 16.0 | 2M1                        | 2000            |
|                      | RCE5C3A220J2M1H03A | C0G  | 1000               | 22pF    | ±5%       | 5.5            | 4.0 | 6.0 | 5.0 | 3.15 | 16.0 | 2M1                        | 2000            |
|                      | RCE5C3A270J2M1H03A | C0G  | 1000               | 27pF    | ±5%       | 5.5            | 4.0 | 6.0 | 5.0 | 3.15 | 16.0 | 2M1                        | 2000            |

• Inside Crimp Taping  
(Lead Style: M\*)

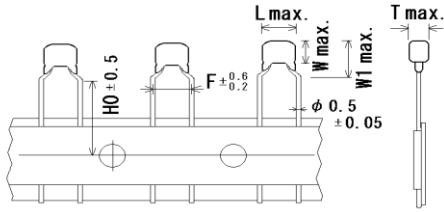

Unit : mm

| Customer Part Number | Murata Part Number | T.C. | DC Rated Volt. (V) | Cap.   | Cap. Tol. | Dimension (mm) |     |     |     |      |      | Dimension (LxW) Lead Style | Pack qty. (pcs) |
|----------------------|--------------------|------|--------------------|--------|-----------|----------------|-----|-----|-----|------|------|----------------------------|-----------------|
|                      |                    |      |                    |        |           | L              | W   | W1  | F   | T    | H/H0 |                            |                 |
|                      | RCE5C3A330J2M1H03A | C0G  | 1000               | 33pF   | ±5%       | 5.5            | 4.0 | 6.0 | 5.0 | 3.15 | 16.0 | 2M1                        | 2000            |
|                      | RCE5C3A390J2M1H03A | C0G  | 1000               | 39pF   | ±5%       | 5.5            | 4.0 | 6.0 | 5.0 | 3.15 | 16.0 | 2M1                        | 2000            |
|                      | RCE5C3A470J2M1H03A | C0G  | 1000               | 47pF   | ±5%       | 5.5            | 4.0 | 6.0 | 5.0 | 3.15 | 16.0 | 2M1                        | 2000            |
|                      | RCE5C3A560J2M1H03A | C0G  | 1000               | 56pF   | ±5%       | 5.5            | 4.0 | 6.0 | 5.0 | 3.15 | 16.0 | 2M1                        | 2000            |
|                      | RCE5C3A680J2M1H03A | C0G  | 1000               | 68pF   | ±5%       | 5.5            | 4.0 | 6.0 | 5.0 | 3.15 | 16.0 | 2M1                        | 2000            |
|                      | RCE5C3A820J2M1H03A | C0G  | 1000               | 82pF   | ±5%       | 5.5            | 4.0 | 6.0 | 5.0 | 3.15 | 16.0 | 2M1                        | 2000            |
|                      | RCE5C3A101J2M1H03A | C0G  | 1000               | 100pF  | ±5%       | 5.5            | 4.0 | 6.0 | 5.0 | 3.15 | 16.0 | 2M1                        | 2000            |
|                      | RCE5C3A121J2M1H03A | C0G  | 1000               | 120pF  | ±5%       | 5.5            | 4.0 | 6.0 | 5.0 | 3.15 | 16.0 | 2M1                        | 2000            |
|                      | RCE5C3A151J2M1H03A | C0G  | 1000               | 150pF  | ±5%       | 5.5            | 4.0 | 6.0 | 5.0 | 3.15 | 16.0 | 2M1                        | 2000            |
|                      | RCE5C3A181J2M1H03A | C0G  | 1000               | 180pF  | ±5%       | 5.5            | 4.0 | 6.0 | 5.0 | 3.15 | 16.0 | 2M1                        | 2000            |
|                      | RCE5C3A221J2M1H03A | C0G  | 1000               | 220pF  | ±5%       | 5.5            | 4.0 | 6.0 | 5.0 | 3.15 | 16.0 | 2M1                        | 2000            |
|                      | RCE5C3A271J2M1H03A | C0G  | 1000               | 270pF  | ±5%       | 5.5            | 4.0 | 6.0 | 5.0 | 3.15 | 16.0 | 2M1                        | 2000            |
|                      | RCE5C3A331J2M1H03A | C0G  | 1000               | 330pF  | ±5%       | 5.5            | 4.0 | 6.0 | 5.0 | 3.15 | 16.0 | 2M1                        | 2000            |
|                      | RCE5C3A391J2M1H03A | C0G  | 1000               | 390pF  | ±5%       | 5.5            | 4.0 | 6.0 | 5.0 | 3.15 | 16.0 | 2M1                        | 2000            |
|                      | RCE5C3A471J2M1H03A | C0G  | 1000               | 470pF  | ±5%       | 5.5            | 4.0 | 6.0 | 5.0 | 3.15 | 16.0 | 2M1                        | 2000            |
|                      | RCE5C3A561J2M1H03A | C0G  | 1000               | 560pF  | ±5%       | 5.5            | 4.0 | 6.0 | 5.0 | 3.15 | 16.0 | 2M1                        | 2000            |
|                      | RCE5C3A681J2M1H03A | C0G  | 1000               | 680pF  | ±5%       | 5.5            | 4.0 | 6.0 | 5.0 | 3.15 | 16.0 | 2M1                        | 2000            |
|                      | RCE5C3A821J2M1H03A | C0G  | 1000               | 820pF  | ±5%       | 5.5            | 4.0 | 6.0 | 5.0 | 3.15 | 16.0 | 2M1                        | 2000            |
|                      | RCE5C3A102J2M1H03A | C0G  | 1000               | 1000pF | ±5%       | 5.5            | 4.0 | 6.0 | 5.0 | 3.15 | 16.0 | 2M1                        | 2000            |

Reference only

| 5. Specification |                                     |   |   |   |      |   |   |   |   |            |          |            |          |            |             |      |   |      |   |
|------------------|-------------------------------------|---|---|---|------|---|---|---|---|------------|----------|------------|----------|------------|-------------|------|---|------|---|
| No.              | Test Item                           | Specification   | Test Method (Compliant Standard:AEC-Q200)   |   |      |   |   |   |   |            |          |            |          |            |             |      |   |      |   |
| 1                | Pre-and Post-Stress Electrical Test |   |   |   |      |   |   |   |   |            |          |            |          |            |             |      |   |      |   |
| 2                | High Temperature Exposure (Storage) | Appearance  | No defects or abnormalities.  | Sit the capacitor for 1000±12h at 150±3°C. Let sit for 24±2h at *room condition, then measure.  |      |   |   |   |   |            |          |            |          |            |             |      |   |      |   |
|                  |                                     | Capacitance Change  | Within ±3% or ±0.3pF (Whichever is larger)  |   |      |   |   |   |   |            |          |            |          |            |             |      |   |      |   |
|                  |                                     | Q   | $30\text{pF} \leq C : Q \geq 350$<br>$10\text{pF} \leq C < 30\text{pF} : Q \geq 275+5C/2$<br>$10\text{pF} > C : Q \geq 200+10C$<br>C : Nominal Capacitance (pF) |   |      |   |   |   |   |            |          |            |          |            |             |      |   |      |   |
|                  |                                     | I.R.  | More than 1,000MΩ or 50 MΩ·μF (Whichever is smaller)  |   |      |   |   |   |   |            |          |            |          |            |             |      |   |      |   |
| 3                | Temperature Cycling                 | Appearance  | No defects or abnormalities.  | Perform the 1000 cycles according to the four heat treatments listed in the following table. Let sit for 24±2 h at *room condition, then measure.   |      |   |   |   |   |            |          |            |          |            |             |      |   |      |   |
|                  |                                     | Capacitance Change  | Within ±5% or ±0.5pF (Whichever is larger)  |   |      |   |   |   |   |            |          |            |          |            |             |      |   |      |   |
|                  |                                     | Q   | $30\text{pF} \leq C : Q \geq 350$<br>$10\text{pF} \leq C < 30\text{pF} : Q \geq 275+5C/2$<br>$10\text{pF} > C : Q \geq 200+10C$<br>C : Nominal Capacitance (pF) |   |      |   |   |   |   |            |          |            |          |            |             |      |   |      |   |
|                  |                                     | I.R.  | 1,000MΩ or 50MΩ · μF min. (Whichever is smaller)  |   |      |   |   |   |   |            |          |            |          |            |             |      |   |      |   |
|                  |                                     | <table border="1"> <thead> <tr> <th>Step</th> <th>1</th> <th>2</th> <th>3</th> <th>4</th> </tr> </thead> <tbody> <tr> <td>Temp. (°C)</td> <td>-55+0/-3</td> <td>Room Temp.</td> <td>125+3/-0</td> <td>Room Temp.</td> </tr> <tr> <td>Time (min.)</td> <td>15±3</td> <td>1</td> <td>15±3</td> <td>1</td> </tr> </tbody> </table> |   |   | Step | 1 | 2 | 3 | 4 | Temp. (°C) | -55+0/-3 | Room Temp. | 125+3/-0 | Room Temp. | Time (min.) | 15±3 | 1 | 15±3 | 1 |
| Step             | 1                                   | 2   | 3   | 4   |      |   |   |   |   |            |          |            |          |            |             |      |   |      |   |
| Temp. (°C)       | -55+0/-3                            | Room Temp.  | 125+3/-0  | Room Temp.  |      |   |   |   |   |            |          |            |          |            |             |      |   |      |   |
| Time (min.)      | 15±3                                | 1   | 15±3  | 1   |      |   |   |   |   |            |          |            |          |            |             |      |   |      |   |
| 4                | Moisture Resistance                 | Appearance  | No defects or abnormalities.  | Apply the 24h heat (25 to 65°C) and humidity (80 to 98%) treatment shown below, 10 consecutive times. Let sit for 24±2 h at *room condition, then measure.  |      |   |   |   |   |            |          |            |          |            |             |      |   |      |   |
|                  |                                     | Capacitance Change  | Within ±5% or ± 0.5pF (Whichever is larger)   |   |      |   |   |   |   |            |          |            |          |            |             |      |   |      |   |
|                  |                                     | Q   | $30\text{pF} \leq C : Q \geq 200$<br>$30\text{pF} > C : Q \geq 100+10C/3$<br>C : Nominal Capacitance (pF)   |   |      |   |   |   |   |            |          |            |          |            |             |      |   |      |   |
|                  |                                     | I.R.  | 500MΩ or 25MΩ · μF min. (Whichever is smaller)  |   |      |   |   |   |   |            |          |            |          |            |             |      |   |      |   |
|                  |                                     | <p>Temperature (°C) vs. Hours. One cycle 24 hours. Humidity 90~98%, Humidity 80~98%, Humidity 90~98%, Humidity 80~98%, Humidity 90~98%. Initial measurement. +10 - 2 °C.</p>  |   |   |      |   |   |   |   |            |          |            |          |            |             |      |   |      |   |
| 5                | Biased Humidity                     | Appearance  | No defects or abnormalities.  | Apply the rated voltage and DC1.3+0.2/-0V (add 100kΩ resistor) at 85±3°C and 80 to 85% humidity for 1000±12h. Remove and let sit for 24±2 h at *room condition, then measure. The charge/discharge current is less than 50mA. |      |   |   |   |   |            |          |            |          |            |             |      |   |      |   |
|                  |                                     | Capacitance Change  | Within ±5% or ± 0.5pF (Whichever is larger)   |   |      |   |   |   |   |            |          |            |          |            |             |      |   |      |   |
|                  |                                     | Q   | $30\text{pF} \leq C : Q \geq 200$<br>$30\text{pF} > C : Q \geq 100+10C/3$<br>C : Nominal Capacitance (pF)   |   |      |   |   |   |   |            |          |            |          |            |             |      |   |      |   |
|                  |                                     | I.R.  | 500MΩ or 25MΩ · μF min. (Whichever is smaller)  |   |      |   |   |   |   |            |          |            |          |            |             |      |   |      |   |

\* "room condition" Temperature : 15 to 35°C, Relative humidity : 45 to 75%, Atmosphere pressure : 86 to 106kPa

Reference only

| No.           | Test Item  | Specification                           | Test Method (Compliant Standard:AEC-Q200)  |   |              |        |                           |               |                           |
|---------------|--|---|--|---|--------------|--------|---------------------------|---------------|---------------------------|
| 6             | Operational Life                                     | Appearance                              | No defects or abnormalities.   |   |              |        |                           |               |                           |
|               |  | Capacitance Change                      | Within $\pm 3\%$ or $\pm 0.3\text{pF}$ (Whichever is larger)   |   |              |        |                           |               |                           |
|               |  | Q                                       | $30\text{pF} \leq C : Q \geq 350$<br>$10\text{pF} \leq C < 30\text{pF} : Q \geq 275+5C/2$<br>$10\text{pF} > C : Q \geq 200+10C$<br>C : Nominal Capacitance (pF)  |   |              |        |                           |               |                           |
|               |  | I.R.                                    | 1,000M $\Omega$ or 50M $\Omega$ · $\mu\text{F}$ min. (Whichever is smaller)  |   |              |        |                           |               |                           |
|               |  |   | Apply voltage in Table for 1000 $\pm$ 12h at 125 $\pm$ 3°C.<br>Let sit for 24 $\pm$ 2 h at *room condition, then measure.<br>The charge/discharge current is less than 50mA. <table border="1" style="margin-left: auto; margin-right: auto;"> <thead> <tr> <th>Rated Voltage</th> <th>Test Voltage</th> </tr> </thead> <tbody> <tr> <td>DC250V</td> <td>150% of the rated voltage</td> </tr> <tr> <td>DC630V, DC1kV</td> <td>120% of the rated voltage</td> </tr> </tbody> </table> | Rated Voltage   | Test Voltage | DC250V | 150% of the rated voltage | DC630V, DC1kV | 120% of the rated voltage |
| Rated Voltage | Test Voltage   |   |  |   |              |        |                           |               |                           |
| DC250V        | 150% of the rated voltage                            |   |  |   |              |        |                           |               |                           |
| DC630V, DC1kV | 120% of the rated voltage                            |   |  |   |              |        |                           |               |                           |
| 7             | External Visual                                      | No defects or abnormalities.            | Visual inspection.   |   |              |        |                           |               |                           |
| 8             | Physical Dimension                                   | Within the specified dimensions.        | Using calipers and micrometers.  |   |              |        |                           |               |                           |
| 9             | Marking  | To be easily legible.                   | Visual inspection.   |   |              |        |                           |               |                           |
| 10            | Resistance to Solvents                               | Appearance                              | No defects or abnormalities.   |   |              |        |                           |               |                           |
|               |  | Capacitance                             | Within the specified tolerance.  |   |              |        |                           |               |                           |
|               |  | Q                                       | $30\text{pF} \leq C : Q \geq 1,000$<br>$30\text{pF} > C : Q \geq 400+20C$<br>C : Nominal Capacitance (pF)  |   |              |        |                           |               |                           |
|               |  | I.R.                                    | More than 10,000M $\Omega$ or 500 M $\Omega$ · $\mu\text{F}$ (Whichever is smaller)  |   |              |        |                           |               |                           |
|               |  |   | Per MIL-STD-202 Method 215<br>Solvent 1 : 1 part (by volume) of isopropyl alcohol<br>3 parts (by volume) of mineral spirits<br>Solvent 2 : Terpene defluxer<br>Solvent 3 : 42 parts (by volume) of water<br>1part (by volume) of propylene glycol monomethyl ether<br>1 part (by volume) of monoethanolamine   |   |              |        |                           |               |                           |
| 11            | Mechanical Shock                                     | Appearance                              | No defects or abnormalities.   |   |              |        |                           |               |                           |
|               |  | Capacitance                             | Within the specified tolerance.  |   |              |        |                           |               |                           |
|               |  | Q                                       | $30\text{pF} \leq C : Q \geq 1,000$<br>$30\text{pF} > C : Q \geq 400+20C$<br>C : Nominal Capacitance (pF)  |   |              |        |                           |               |                           |
|               |  |   | Three shocks in each direction should be applied along 3 mutually perpendicular axes of the test specimen (18 shocks).<br>The specified test pulse should be Half-sine and should have a duration : 0.5ms, peak value : 1500G and velocity change : 4.7m/s.  |   |              |        |                           |               |                           |
| 12            | Vibration  | Appearance                              | No defects or abnormalities.   |   |              |        |                           |               |                           |
|               |  | Capacitance                             | Within the specified tolerance.  |   |              |        |                           |               |                           |
|               |  | Q                                       | $30\text{pF} \leq C : Q \geq 1,000$<br>$30\text{pF} > C : Q \geq 400+20C$<br>C : Nominal Capacitance (pF)  |   |              |        |                           |               |                           |
|               |  |   | The capacitor should be subjected to a simple harmonic motion having a total amplitude of 1.5mm, the frequency being varied uniformly between the approximate limits of 10 and 2000Hz. The frequency range, from 10 to 2,000Hz and return to 10Hz, should be traversed in approximately 20 min. This motion should be applied for 12 items in each 3 mutually perpendicular directions (total of 36 times).  |   |              |        |                           |               |                           |
| 13-1          | Resistance to Soldering Heat (Non-Preheat)           | Appearance                              | No defects or abnormalities.   |   |              |        |                           |               |                           |
|               |  | Capacitance Change                      | Within $\pm 2.5\%$ or $\pm 0.25\text{pF}$ (Whichever is larger)  |   |              |        |                           |               |                           |
|               |  | Dielectric Strength (Between terminals) | No defects   |   |              |        |                           |               |                           |
|               |  |   |  | • Post-treatment<br>Capacitor should be stored for 24 $\pm$ 2 hours at *room condition. |              |        |                           |               |                           |
| 13-2          | Resistance to Soldering Heat (On-Preheat)            | Appearance                              | No defects or abnormalities.   |   |              |        |                           |               |                           |
|               |  | Capacitance Change                      | Within $\pm 2.5\%$ or $\pm 0.25\text{pF}$ (Whichever is larger)  |   |              |        |                           |               |                           |
|               |  | Dielectric Strength (Between terminals) | No defects   |   |              |        |                           |               |                           |
|               |  |   |  | • Post-treatment<br>Capacitor should be stored for 24 $\pm$ 2 hours at *room condition. |              |        |                           |               |                           |
| 13-3          | Resistance to Soldering Heat (soldering iron method) | Appearance                              | No defects or abnormalities.   |   |              |        |                           |               |                           |
|               |  | Capacitance Change                      | Within $\pm 2.5\%$ or $\pm 0.25\text{pF}$ (Whichever is larger)  |   |              |        |                           |               |                           |
|               |  | Dielectric Strength (Between terminals) | No defects   |   |              |        |                           |               |                           |
|               |  |   |  | • Post-treatment<br>Capacitor should be stored for 24 $\pm$ 2 hours at *room condition. |              |        |                           |               |                           |

\* "room condition" Temperature : 15 to 35°C, Relative humidity : 45 to 75%, Atmosphere pressure : 86 to 106kPa

Reference only

| No.  | Test Item                   | Specification   | Test Method (Compliant Standard:AEC-Q200)   |               |              |         |                           |                |                           |                     |                           |                        |
|--|-----------------------------|---|---|---------------|--------------|---------|---------------------------|----------------|---------------------------|---------------------|---------------------------|------------------------|
| 14   | Thermal Shock               | Appearance  | No defects or abnormalities.  |               |              |         |                           |                |                           |                     |                           |                        |
|  |                             | Capacitance Change  | Within $\pm 5\%$ or $\pm 0.5\text{pF}$<br>(Whichever is larger)   |               |              |         |                           |                |                           |                     |                           |                        |
|  |                             | Q   | $30\text{pF} \leq C : Q \geq 350$<br>$10\text{pF} \leq C < 30\text{pF} : Q \geq 275+5C/2$<br>$10\text{pF} > C : Q \geq 200+10C$<br><br>C : Nominal Capacitance (pF)   |               |              |         |                           |                |                           |                     |                           |                        |
|  |                             | I.R.  | 1,000M $\Omega$ or 50M $\Omega$ · $\mu\text{F}$ min.<br>(Whichever is smaller)  |               |              |         |                           |                |                           |                     |                           |                        |
|  |                             |   | Perform the 300 cycles according to the two heat treatments listed in the following table(Maximum transfer time is 20s.). Let sit for 24 $\pm$ 2 h at *room condition, then measure. <table border="1" style="margin-left: auto; margin-right: auto;"> <thead> <tr> <th>Step</th> <th>1</th> <th>2</th> </tr> </thead> <tbody> <tr> <td>Temp. (°C)</td> <td>-55+0/-3</td> <td>125+3/-0</td> </tr> <tr> <td>Time (min.)</td> <td>15<math>\pm</math>3</td> <td>15<math>\pm</math>3</td> </tr> </tbody> </table>   | Step          | 1            | 2       | Temp. (°C)                | -55+0/-3       | 125+3/-0                  | Time (min.)         | 15 $\pm$ 3                | 15 $\pm$ 3             |
| Step   | 1                           | 2   |   |               |              |         |                           |                |                           |                     |                           |                        |
| Temp. (°C)   | -55+0/-3                    | 125+3/-0  |   |               |              |         |                           |                |                           |                     |                           |                        |
| Time (min.)  | 15 $\pm$ 3                  | 15 $\pm$ 3  |   |               |              |         |                           |                |                           |                     |                           |                        |
| 15   | ESD                         | Appearance  | No defects or abnormalities.  |               |              |         |                           |                |                           |                     |                           |                        |
|  |                             | Capacitance   | Within the specified tolerance.   |               |              |         |                           |                |                           |                     |                           |                        |
|  |                             | Q   | $30\text{pF} \leq C : Q \geq 1,000$<br>$30\text{pF} > C : Q \geq 400+20C$<br><br>C : Nominal Capacitance (pF)   |               |              |         |                           |                |                           |                     |                           |                        |
|  |                             | I.R.  | More than 10,000M $\Omega$ or 500 M $\Omega$ · $\mu\text{F}$<br>(Whichever is smaller)  |               |              |         |                           |                |                           |                     |                           |                        |
|  |                             |   | Per AEC-Q200-002  |               |              |         |                           |                |                           |                     |                           |                        |
| 16   | Solderability               | Lead wire should be soldered with uniform coating on the axial direction over 95% of the circumferential direction. | Should be placed into steam aging for 8h $\pm$ 15 min.<br>The terminal of capacitor is dipped into a solution of rosin ethanol (25% rosin in weight proportion).<br>Immerse in solder solution for 2 $\pm$ 0.5 seconds.<br>In both cases the depth of dipping is up to about 1.5 to 2mm from the terminal body.<br>Temp. of solder : 245 $\pm$ 5°C (Sn-3.0Ag-0.5Cu)   |               |              |         |                           |                |                           |                     |                           |                        |
| 17   | Electrical Characterization | Appearance  | No defects or abnormalities.  |               |              |         |                           |                |                           |                     |                           |                        |
|  |                             | Capacitance   | Within the specified tolerance.   |               |              |         |                           |                |                           |                     |                           |                        |
|  |                             | Q   | $30\text{pF} \leq C : Q \geq 1,000$<br>$30\text{pF} > C : Q \geq 400+20C$<br><br>C : Nominal Capacitance (pF)   |               |              |         |                           |                |                           |                     |                           |                        |
|  |                             | I.R.  | Between Terminals<br>10,000M $\Omega$ or 50M $\Omega$ · $\mu\text{F}$ min.<br>(Whichever is smaller)  |               |              |         |                           |                |                           |                     |                           |                        |
|  |                             | Dielectric Strength   | Between Terminals<br>No defects or abnormalities.   |               |              |         |                           |                |                           |                     |                           |                        |
|  |                             |   | Visual inspection.<br>The capacitance, Q should be measured at 25°C at the frequency and voltage shown in the table. <table border="1" style="margin-left: auto; margin-right: auto;"> <thead> <tr> <th>Nominal Cap.</th> <th>Frequency</th> <th>Voltage</th> </tr> </thead> <tbody> <tr> <td><math>C \leq 1000\text{pF}</math></td> <td>1<math>\pm</math>0.1MHz</td> <td>AC0.5 to 5V(r.m.s.)</td> </tr> <tr> <td><math>C &gt; 1000\text{pF}</math></td> <td>1<math>\pm</math>0.1kHz</td> <td>AC1<math>\pm</math>0.2V(r.m.s.)</td> </tr> </tbody> </table>            | Nominal Cap.  | Frequency    | Voltage | $C \leq 1000\text{pF}$    | 1 $\pm$ 0.1MHz | AC0.5 to 5V(r.m.s.)       | $C > 1000\text{pF}$ | 1 $\pm$ 0.1kHz            | AC1 $\pm$ 0.2V(r.m.s.) |
| Nominal Cap.   | Frequency                   | Voltage   |   |               |              |         |                           |                |                           |                     |                           |                        |
| $C \leq 1000\text{pF}$   | 1 $\pm$ 0.1MHz              | AC0.5 to 5V(r.m.s.)   |   |               |              |         |                           |                |                           |                     |                           |                        |
| $C > 1000\text{pF}$  | 1 $\pm$ 0.1kHz              | AC1 $\pm$ 0.2V(r.m.s.)  |   |               |              |         |                           |                |                           |                     |                           |                        |
|  |                             |   | The insulation resistance should be measured with DC500 $\pm$ 50V (DC250V $\pm$ 25V in case of rated voltage : DC250V) at 25 °C within 2 min. of charging.  |               |              |         |                           |                |                           |                     |                           |                        |
|  |                             |   | The capacitor should not be damaged when voltage in Table is applied between the terminations for 1 to 5 seconds.<br>(Charge/Discharge current $\leq$ 50mA.) <table border="1" style="margin-left: auto; margin-right: auto;"> <thead> <tr> <th>Rated Voltage</th> <th>Test Voltage</th> </tr> </thead> <tbody> <tr> <td>DC250V</td> <td>200% of the rated voltage</td> </tr> <tr> <td>DC630V</td> <td>150% of the rated voltage</td> </tr> <tr> <td>DC1kV</td> <td>130% of the rated voltage</td> </tr> </tbody> </table>  | Rated Voltage | Test Voltage | DC250V  | 200% of the rated voltage | DC630V         | 150% of the rated voltage | DC1kV               | 130% of the rated voltage |                        |
| Rated Voltage  | Test Voltage                |   |   |               |              |         |                           |                |                           |                     |                           |                        |
| DC250V   | 200% of the rated voltage   |   |   |               |              |         |                           |                |                           |                     |                           |                        |
| DC630V   | 150% of the rated voltage   |   |   |               |              |         |                           |                |                           |                     |                           |                        |
| DC1kV  | 130% of the rated voltage   |   |   |               |              |         |                           |                |                           |                     |                           |                        |
|  |                             |   | The capacitor is placed in a container with metal balls of 1mm diameter so that each terminal, short-circuit is kept approximately 2mm from the balls, and voltage in table is impressed for 1 to 5 seconds between capacitor terminals and metal balls.<br>(Charge/Discharge current $\leq$ 50mA.) <table border="1" style="margin-left: auto; margin-right: auto;"> <thead> <tr> <th>Rated Voltage</th> <th>Test Voltage</th> </tr> </thead> <tbody> <tr> <td>DC250V</td> <td>DC500V</td> </tr> <tr> <td>DC630V,DC1kV</td> <td>DC1.3kV</td> </tr> </tbody> </table> | Rated Voltage | Test Voltage | DC250V  | DC500V                    | DC630V,DC1kV   | DC1.3kV                   |                     |                           |                        |
| Rated Voltage  | Test Voltage                |   |   |               |              |         |                           |                |                           |                     |                           |                        |
| DC250V   | DC500V                      |   |   |               |              |         |                           |                |                           |                     |                           |                        |
| DC630V,DC1kV   | DC1.3kV                     |   |   |               |              |         |                           |                |                           |                     |                           |                        |
| * "room condition" Temperature : 15 to 35°C, Relative humidity : 45 to 75%, Atmosphere pressure : 86 to 106kPa |                             |   |   |               |              |         |                           |                |                           |                     |                           |                        |

Reference only

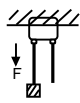
| No.  | Test Item                               |                  | Specification   | Test Method (Compliant Standard:AEC-Q200)   |      |                 |   |      |   |       |   |      |   |       |   |      |
|------|---|------------------|---|---|------|-----------------|---|------|---|-------|---|------|---|-------|---|------|
| 18   | Terminal Strength                       | Tensile Strength | Termination not to be broken or loosened.   | As in the figure, fix the capacitor body, apply the force gradually to each lead in the radial direction of the capacitor until reaching 10N and then keep the force applied for 10±1 seconds.<br>   |      |                 |   |      |   |       |   |      |   |       |   |      |
|      |   | Bending Strength | Termination not to be broken or loosened.   | Each lead wire should be subjected to a force of 2.5N and then be bent 90° at the point of egress in one direction. Each wire is then returned to the original position and bent 90° in the opposite direction at the rate of one bend per 2 to 3 seconds.  |      |                 |   |      |   |       |   |      |   |       |   |      |
| 19   | Capacitance Temperature Characteristics |                  | Within the specified Tolerance.<br>25°C to 125°C : 0±30ppm/°C<br>-55°C to 25°C : 0+30/-72ppm/°C | <p>The capacitance change should be measured after 5min. at each specified temperature step.</p> <table border="1" data-bbox="986 622 1212 801"> <thead> <tr> <th>Step</th> <th>Temperature(°C)</th> </tr> </thead> <tbody> <tr> <td>1</td> <td>25±2</td> </tr> <tr> <td>2</td> <td>-55±3</td> </tr> <tr> <td>3</td> <td>25±2</td> </tr> <tr> <td>4</td> <td>125±3</td> </tr> <tr> <td>5</td> <td>25±2</td> </tr> </tbody> </table> <p>The temperature coefficient is determined using the capacitance measured in step 3 as a reference. When cycling the temperature sequentially from step 1 through 5 (-55°C to 125°C) the capacitance should be within the specified tolerance for the temperature coefficient and capacitance change as Table A. The capacitance drift is calculated by dividing the differences between the maximum and minimum measured values in the step 1, 3 and 5 by the capacitance value in step 3.</p> | Step | Temperature(°C) | 1 | 25±2 | 2 | -55±3 | 3 | 25±2 | 4 | 125±3 | 5 | 25±2 |
| Step | Temperature(°C)                         |                  |   |   |      |                 |   |      |   |       |   |      |   |       |   |      |
| 1    | 25±2                                    |                  |   |   |      |                 |   |      |   |       |   |      |   |       |   |      |
| 2    | -55±3                                   |                  |   |   |      |                 |   |      |   |       |   |      |   |       |   |      |
| 3    | 25±2                                    |                  |   |   |      |                 |   |      |   |       |   |      |   |       |   |      |
| 4    | 125±3                                   |                  |   |   |      |                 |   |      |   |       |   |      |   |       |   |      |
| 5    | 25±2                                    |                  |   |   |      |                 |   |      |   |       |   |      |   |       |   |      |

6. Packing specification

- Bulk type (Package : B)

The size of packing case and packing way

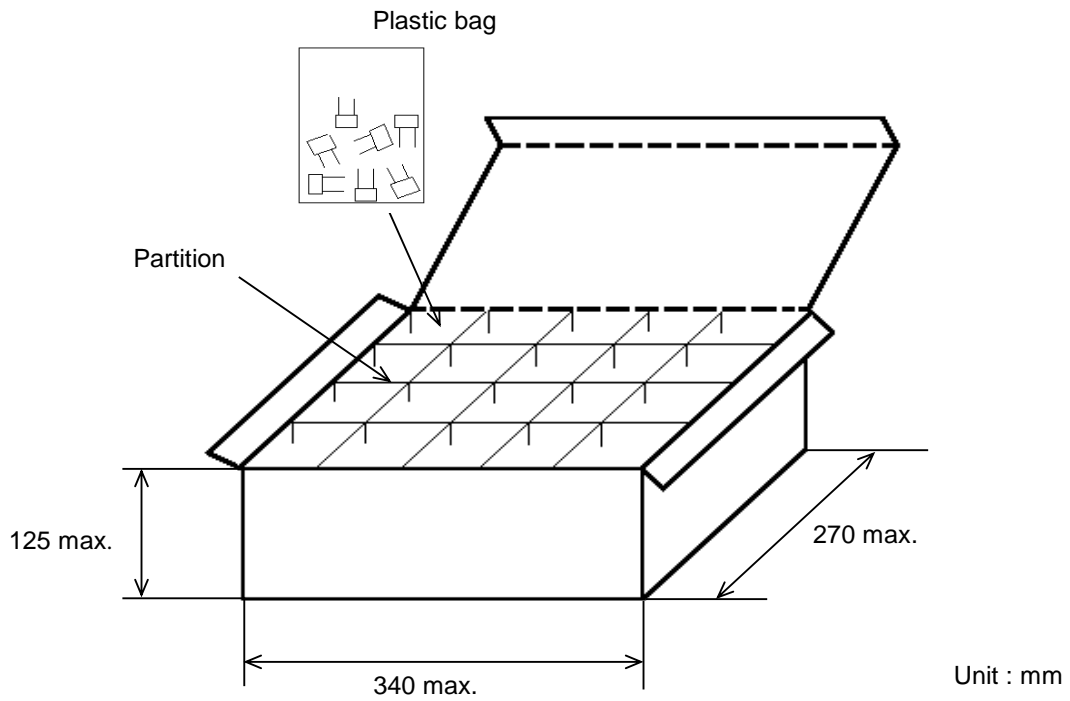

$$\text{The number of packing} = {}^*1 \text{ Packing quantity} \times {}^*2 n$$

\*1 : Please refer to [Part number list].

\*2 : Standard n = 20 (bag)

Note)

The outer package and the number of outer packing be changed by the order getting amount.

• Ammo pack taping type (Package : A)

- The tape with capacitors is packed zigzag into a case.
- There should be 3 pitches and over without capacitors in leader and trailer.

The size of packing case and packing way

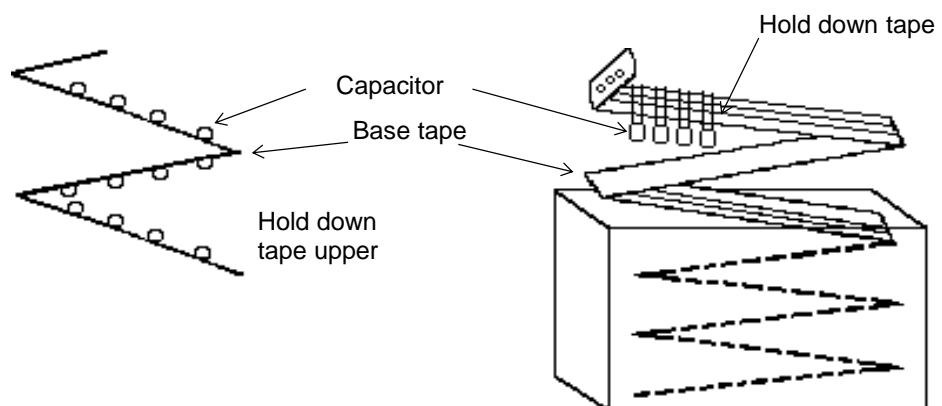
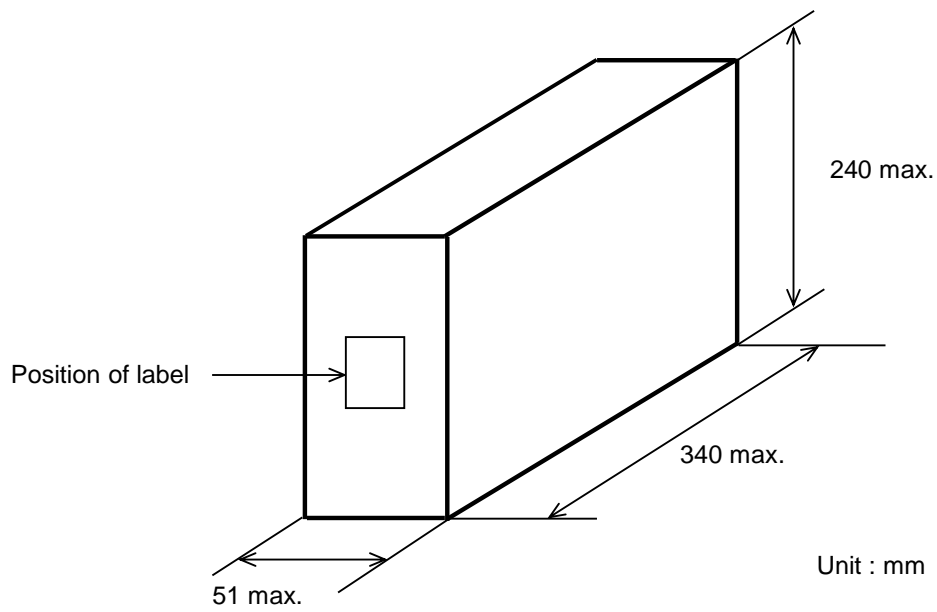

## 7. Taping specification

## 7-1. Dimension of capacitors on tape

Inside crimp taping type &lt; Lead Style : M1 &gt;

Pitch of component 12.7mm / Lead spacing 5.0mm

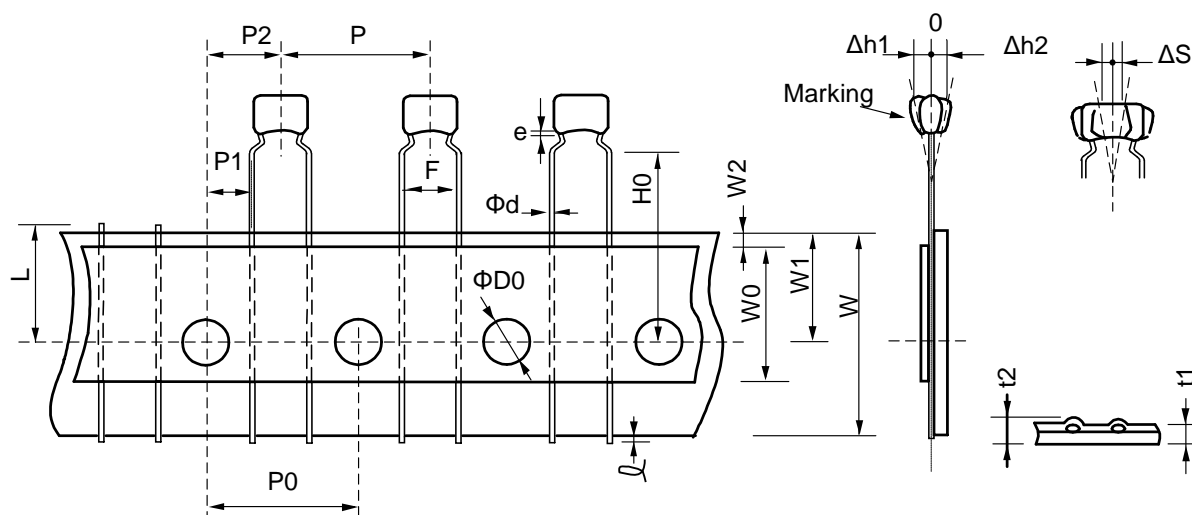

Unit : mm

| Item   | Code | Dimensions                    | Remarks                               |
|--|------|-------------------------------|---------------------------------------|
| Pitch of component                               | P    | 12.7+/-1.0                    |                                       |
| Pitch of sprocket hole                           | P0   | 12.7+/-0.2                    |                                       |
| Lead spacing                                     | F    | 5.0+0.6/-0.2                  |                                       |
| Length from hole center to component center      | P2   | 6.35+/-1.3                    | Deviation of progress direction       |
| Length from hole center to lead                  | P1   | 3.85+/-0.7                    |                                       |
| Deviation along tape, left or right defect       | ΔS   | 0+/-2.0                       | They include deviation by lead bend   |
| Carrier tape width                               | W    | 18.0+/-0.5                    |                                       |
| Position of sprocket hole                        | W1   | 9.0+0/-0.5                    | Deviation of tape width direction     |
| Lead distance between reference and bottom plane | H0   | 16.0+/-0.5                    |                                       |
| Protrusion length                                | ℓ    | 0.5 max.                      |                                       |
| Diameter of sprocket hole                        | ΦD0  | 4.0+/-0.1                     |                                       |
| Lead diameter                                    | Φd   | 0.5+/-0.05                    |                                       |
| Total tape thickness                             | t1   | 0.6+/-0.3                     | They include hold down tape thickness |
| Total thickness of tape and lead wire            | t2   | 1.5 max.                      |                                       |
| Deviation across tape                            | Δh1  | 2.0 max. (Dimension code : W) |                                       |
|  | Δh2  | 1.0 max. (except as above)    |                                       |
| Portion to cut in case of defect                 | L    | 11.0+0/-1.0                   |                                       |
| Hold down tape width                             | W0   | 9.5 min.                      |                                       |
| Hold down tape position                          | W2   | 1.5+/-1.5                     |                                       |
| Coating extension on lead                        | e    | Up to the end of crimp        |                                       |

7-2. Splicing way of tape

- 1) Adhesive force of tape is over 3N at test condition as below.

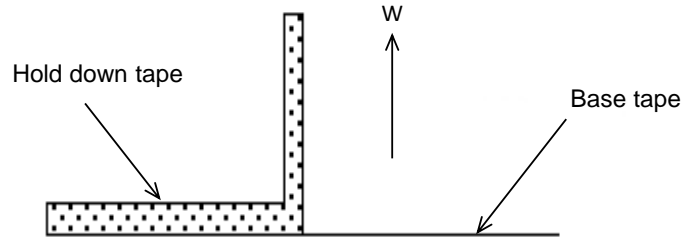

2) Splicing of tape

- (a) When base tape is spliced

- Base tape shall be spliced by cellophane tape.
- (Total tape thickness shall be less than 1.05mm.)

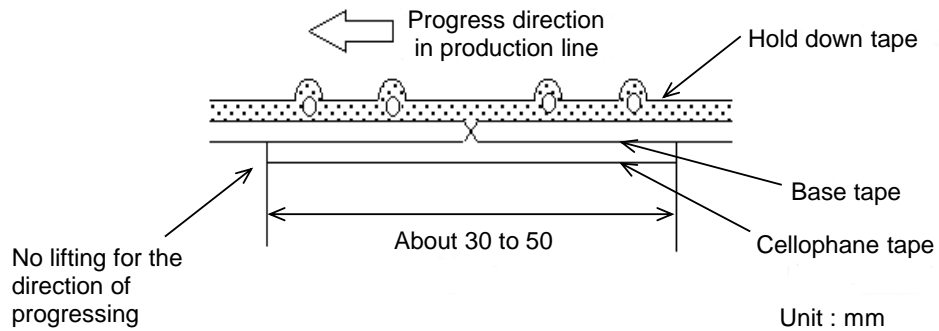

- (b) When hold down tape is spliced

- Hold down tape shall be spliced with overlapping.
- (Total tape thickness shall be less than 1.05mm.)

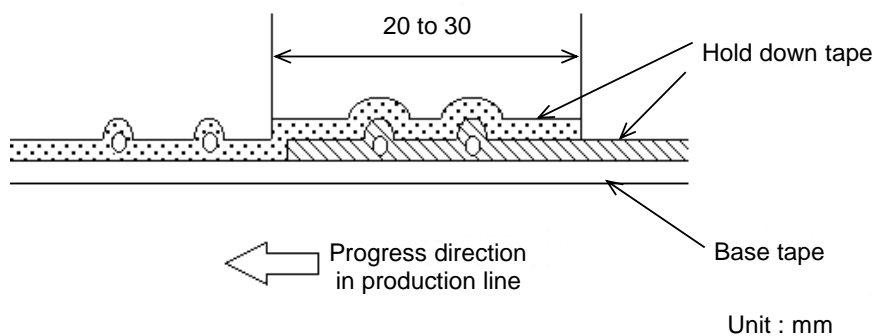

- (c) When both tape are spliced

- Base tape and hold down tape shall be spliced with splicing tape.

3) Missing components

- There should be no consecutive missing of more than three components.
- The number of missing components should be not more than 0.5 % of total components that should be present in a Ammo pack.

**⚠ CAUTION****1. OPERATING VOLTAGE**

Do not apply a voltage to the capacitor that exceeds the rated voltage as called out in the specifications.

1-1. Applied voltage between the terminals of a capacitor shall be less than or equal to the rated voltage.

(1) When AC voltage is superimposed on DC voltage, the zero-to-peak voltage shall not exceed the rated DC voltage. When AC voltage or pulse voltage is applied, the peak-to-peak voltage shall not exceed the rated DC voltage.

(2) Abnormal voltages (surge voltage, static electricity, pulse voltage, etc.) shall not exceed the rated DC voltage.

Typical Voltage Applied to the DC Capacitor

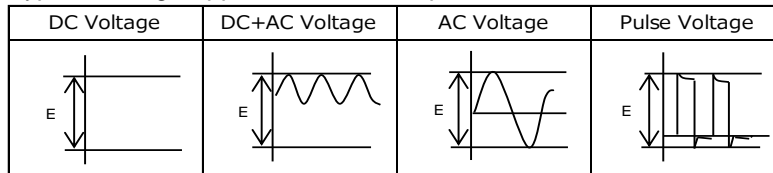

(E: Maximum possible applied voltage.)

1-2. Influence of over voltage

Over voltage that is applied to the capacitor may result in an electrical short circuit caused by the breakdown of the internal dielectric layers. The time duration until breakdown depends on the applied voltage and the ambient temperature.

Use a safety standard certified capacitor in a power supply input circuit (AC filter), as it is also necessary to consider the withstand voltage and impulse withstand voltage defined for each device.

**2. OPERATING TEMPERATURE AND SELF-GENERATED HEAT**

Keep the surface temperature of a capacitor below the upper limit of its rated operating temperature range. Be sure to take into account the heat generated by the capacitor itself.

When the capacitor is used in a high-frequency current, pulse current or the like, it may have the self-generated heat due to dielectric-loss.

In case of Class 2 capacitors (Temp.Char. : X7R,X7S,X8L, etc.), applied voltage should be the load such as self-generated heat is within 20 °C on the condition of atmosphere temperature 25 °C.

Since the self-heating is low in the Class 1 capacitors (Temp.Char.: COG,U2J,X8G, etc.), the allowable power becomes extremely high compared to the Class 2 capacitors.

However, when a load with self-heating of 20°C is applied at the rated voltage, the allowable power may be exceeded. Please confirm that there is no rising trend of the capacitor's surface temperature and that the surface temperature of the capacitor does not exceed the maximum operating temperature.

Excessive generation of heat may cause deterioration of the characteristics and reliability of the capacitor.

When measuring the self-heating temperature, be aware that accurate measurement may not be possible due to the following effects.

- The heat generated by other parts
- Air flow such as convection and cooling fans
- Temperature sensor used for measuring surface temperature of capacitor

In the case using a thermocouple, it is recommended that use a K thermocouple of  $\Phi 0.1\text{mm}$  with less heat capacity.

**3. FAIL-SAFE**

Capacitors that are cracked by dropping or bending of the board may cause deterioration of the insulation resistance, and result in a short.

If the circuit being used may cause an electrical shock, smoke or fire when a capacitor is shorted, be sure to install fail-safe functions, such as a fuse, to prevent secondary accidents.

#### 4. OPERATING AND STORAGE ENVIRONMENT

The insulating coating of capacitors does not form a perfect seal; therefore, do not use or store capacitors in a corrosive atmosphere, especially where chloride gas, sulfide gas, acid, alkali, salt or the like are present. And avoid exposure to moisture. Before cleaning, bonding, or molding this product, verify that these processes do not affect product quality by testing the performance of a cleaned, bonded or molded product in the intended equipment. Store the capacitors where the temperature and relative humidity do not exceed 5 to 40 °C and 20 to 70%. Use capacitors within 6 months.

Use capacitors within 6 months after delivered. Check the solderability after 6 months or more.

Due to moisture condensation caused by rapid humidity changes, or the photochemical change caused by direct sunlight on the terminal electrodes, the solderability and electrical performance may deteriorate. Do not store capacitors under direct sunlight or in high humidity conditions.

#### 5. VIBRATION AND IMPACT

Do not expose a capacitor or its leads to excessive shock or vibration during use.

5-1. Mechanical shock due to being dropped may cause damage or a crack in the dielectric material of the capacitor.

Do not use a dropped capacitor because the quality and reliability may be deteriorated.

5-2. Excessive shock or vibration may cause to fatigue destruction of lead wires mounted on the circuit board. If necessary, take measures to hold a capacitor on the circuit boards by adhesive, molding resin or coating and other.

Please confirm there is no influence of holding measures on the product with an intended equipment.

#### 6. SOLDERING

When soldering this product to a PCB/PWB, do not exceed the solder heat resistance specification of the capacitor. Subjecting this product to excessive heating could melt the internal junction solder and may result in thermal shocks that can crack the ceramic element.

Please verify that the soldering process does not affect the quality of capacitors.

##### 6-1. Flow Soldering

|                        |               |
|------------------------|---------------|
| Soldering temperature  | : 260 °C max. |
| Soldering time         | : 7.5 s max.  |
| Preheating temperature | : 120 °C max. |
| Preheating time        | : 60 s max.   |

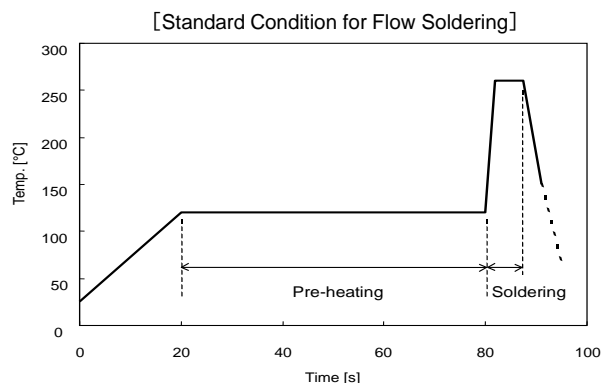

##### 6-2. Reflow Soldering

Do not apply reflow soldering.

##### 6-3. Soldering Iron

|                         |               |
|-------------------------|---------------|
| Temperature of iron-tip | : 350 °C max. |
| Soldering iron wattage  | : 60 W max.   |
| Soldering time          | : 3.5 s max.  |

## 7. BONDING AND RESIN MOLDING, RESIN COAT

In case of bonding, molding or coating this product, verify that these processes do not affect the quality of capacitor by testing the performance of a bonded or molded product in the intended equipment.

In case of the amount of applications, dryness / hardening conditions of adhesives and molding resins containing organic solvents (ethyl acetate, methyl ethyl ketone, toluene, etc.) are unsuitable, the outer coating resin of a capacitor is damaged by the organic solvents and it may result, worst case, in a short circuit.

The variation in thickness of adhesive or molding resin may cause a outer coating resin cracking and/or ceramic element cracking of a capacitor in a temperature cycling.

## 8. TREATMENT AFTER BONDING AND RESIN MOLDING, RESIN COAT

When the outer coating is hot (over 100 °C) after soldering, it becomes soft and fragile.

So please be careful not to give it mechanical stress.

Failure to follow the above cautions may result, worst case, in a short circuit and cause fuming or partial dispersion when the product is used.

## 9. LIMITATION OF APPLICATIONS

The products listed in the specification(hereinafter the product(s) is called as the "Product(s)") are designed and manufactured for applications specified in the specification. (hereinafter called as the "Specific Application")

We shall not warrant anything in connection with the Products including fitness, performance, adequateness, safety, or quality, in the case of applications listed in from (1) to (11) written at the end of this precautions, which may generally require high performance, function, quality, management of production or safety.

Therefore, the Product shall be applied in compliance with the specific application.

WE DISCLAIM ANY LOSS AND DAMAGES ARISING FROM OR IN CONNECTION WITH THE PRODUCTS INCLUDING BUT NOT LIMITED TO THE CASE SUCH LOSS AND DAMAGES CAUSED BY THE UNEXPECTED ACCIDENT, IN EVENT THAT (i) THE PRODUCT IS APPLIED FOR THE PURPOSE WHICH IS NOT SPECIFIED AS THE SPECIFIC APPLICATION FOR THE PRODUCT, AND/OR (ii) THE PRODUCT IS APPLIED FOR ANY FOLLOWING APPLICATION PURPOSES FROM (1) TO (11) (EXCEPT THAT SUCH APPLICATION PURPOSE IS UNAMBIGUOUSLY SPECIFIED AS SPECIFIC APPLICATION FOR THE PRODUCT IN THE SPECIFICATION.\*)

1. Aircraft equipment
2. Aerospace equipment
3. Undersea equipment
4. Power plant control equipment
5. Medical equipment
6. Transportation equipment
7. Traffic control equipment
8. Disaster prevention/security equipment
9. Industrial data-processing equipment
10. Combustion/explosion control equipment
11. Equipment with complexity and/or required reliability equivalent to the applications listed in the above.

For exploring information of the Products which will be compatible with the particular purpose other than those specified in the specification, please contact our sales offices, distribution agents, or trading companies with which you make a deal, or via our web contact form.

Contact form: <https://www.murata.com/contactform>

\*We may design and manufacture particular Products for applications listed in (1) to (11). Provided that, in such case we shall unambiguously specify such Specific Application in the specification without any exception.

Therefore, any other documents and/or performances, whether exist or non-exist, shall not be deemed as the evidence to imply that we accept the applications listed in (1) to (11).

**NOTICE****1. CLEANING**

- 1-1. Please evaluate the capacitor using actual cleaning equipment and conditions to confirm the quality, and select the solvent for cleaning.
- 1-2. Unsuitable cleaning may leave residual flux or other foreign substances, causing deterioration of electrical characteristics and the reliability of the capacitors.
- 1-3. To perform ultrasonic cleaning, observe the following conditions.
  - Rinse bath capacity : Output of 20 watts per liter or less.
  - Rinsing time : 5 min maximum.
  - Do not vibrate the PCB/PWB directly.
  - Excessive ultrasonic cleaning may lead to fatigue destruction of the lead wires.

**2. SOLDERING AND MOUNTING**

- 2-1. Insert the lead wire into the PCB with a distance appropriate to the lead space.  
If the lead wires are inserted into different spacing holes, cracks may occur in the outer resin or the internal element.
- 2-2. When bending the lead wire, excessive force applied to the capacitor body may cause cracks in the outer resin or the internal element. Hold the lead wire closer to the capacitor body than the lead wire bending position with the fixture, then bend it.

(See the right figure)

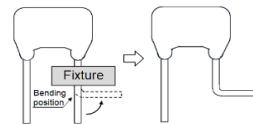

- 2-3. When cutting and clinching the lead wire, do not apply excessive force to the capacitor body.
- 2-4. When soldering, insert the lead wire into the PCB without mechanically stressing the lead wire.

**3. CAPACITANCE CHANGE OF CAPACITORS**

- Class 2 capacitors (Temp.Char. : X7R,X7S,X8L etc.)  
Class 2 capacitors an aging characteristic, whereby the capacitor continually decreases its capacitance slightly if the capacitor leaves for a long time. Moreover, capacitance might change greatly depending on a surrounding temperature or an applied voltage. So, it is not likely to be able to use for the time constant circuit.  
Please contact us if you need a detail information.

**4. CHARACTERISTICS EVALUATION IN THE ACTUAL SYSTEM**

- 4-1. Evaluate the capacitor in the actual system, to confirm that there is no problem with the performance and specification values in a finished product before using.
- 4-2. Since a voltage dependency and temperature dependency exists in the capacitance of Class 2 ceramic capacitors, the capacitance may change depending on the operating conditions in the actual system. Therefore, be sure to evaluate the various characteristics, such as the leakage current and noise absorptivity, which will affect the capacitance value of the capacitor.
- 4-3. In addition, voltages exceeding the predetermined surge may be applied to the capacitor by the inductance in the actual system.  
Evaluate the surge resistance in the actual system as required.
- 4-4. When using Class 2 ceramic capacitors in AC or pulse circuits, the capacitor itself vibrates at specific frequencies and noise may be generated. Moreover, when the mechanical vibration or shock is added to capacitor, noise may occur.

**⚠ NOTE**

1. Please make sure that your product has been evaluated in view of your specifications with our product being mounted to your product.
2. You are requested not to use our product deviating from this product specification.

## Looking for pricing, stock, or lifecycle information?

Click below to explore more details on WIN SOURCE:

- ⊖ [View RCE5C3A101J2M1H03A on WIN SOURCE](#)
- ⊖ [Murata Electronics North America Information](#)

## Optimize Your Supply Chain with WIN SOURCE Solutions

- ✓ Global Sourcing Solution
- ✓ Obsolete Management
- ✓ Cost Control Management
- ✓ Shortage Management
- ✓ Alternative Solution
- ✓ Excess Inventory Management