



**THE DATASHEET OF
AWSZT-8.00CV-T**



3.7 x 3.1 mm INDUSTRIAL GRADE CERAMIC RESONATOR

AWSZT-CV

RoHS/RoHS II Compliant
Pb in ceramic, exemption (7c-I)



3.7 x 3.1 mm

FEATURES:

- Low resonant impedance
- IR reflow capable
- Low cost

APPLICATIONS:

- Remote controls, Microprocessor clocks, Mobile phones, DVD & CD-Roms, Electric appliances
- Consumer electronics

ELECTRICAL CHARACTERISTICS:

Parameters	Minimum	Typical	Maximum	Units	Notes
Frequency Range	8.00		13.00	MHz	
	16.00		60.00		
Resonant Impedance (Ro)			30	Ω	8.00 MHz – 13.00 MHz
			40		16.00 MHz – 20.00 MHz
			40		20.01 MHz – 25.99 MHz
			40		26.00 MHz – 60.00 MHz
Load Capacitance for Test Circuit (C1=C2)	30 – 20%	30	30 + 20%	pF	8.00 MHz – 13.00 MHz
	30 – 20%	30	30 + 20%		16.00 MHz – 20.00 MHz
	15 – 20%	15	15 + 20%		20.01 MHz – 25.99 MHz
	5 – 20%	5	5 + 20%		26.00 MHz – 60.00 MHz
Frequency Tolerance @25 °C	-0.5		0.5	%	
Frequency Stability @ -25°C to +85°C	-0.4		0.4	%	8.00 MHz – 13.00 MHz
	-0.3		0.3		16.00 MHz – 60.00 MHz
Withstanding Voltage		50		V	DC , 1 min
Rating Voltage	(1) D.C. Voltage		6	V	
	(2) A.C. Voltage		15	Vp-p.	
Insulation Resistance	100			MΩ	10V, 1min
Operation Temperature	-25		85	°C	
Storage Temperature	-55		85	°C	
Aging Rate (Fosc) (10 years)	-0.3		0.3	%	

TEST CONDITION AND TEST CIRCUIT:

Parts shall be measured under a condition (Temp.: 20±15°C, Humidity: 65±20% R.H.) unless the standard condition (Temp: 25±3°C, Humidity: 65±10% R.H.) is regulated to measure

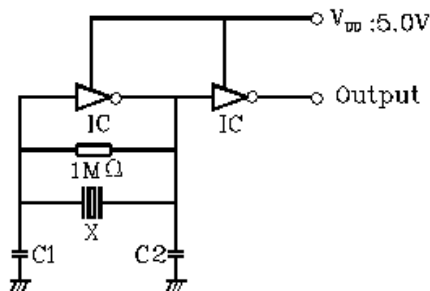

X: Ceramic Resonator
 C1=C2: 30pF ±20% (8.00MHz~13.00MHz)
 30pF ±20% (16.00MHz~20.00MHz)
 15pF ±20% (20.01MHz~25.99MHz)
 5pF ±20% (26.00MHz~60.00MHz)

OPTIONS & PART IDENTIFICATION:

AWSZT – XX.XXCV – □

Frequency
Frequency in MHz

Packaging
T: 1000pcs/Reel
Blank: Bulk

3.7 x 3.1 mm INDUSTRIAL GRADE CERAMIC RESONATOR

AWSZT-CV

RoHS/RoHS II Compliant
Pb in ceramic, exemption (7c-I)



3.7 x 3.1 mm

OUTLINE DRAWING:

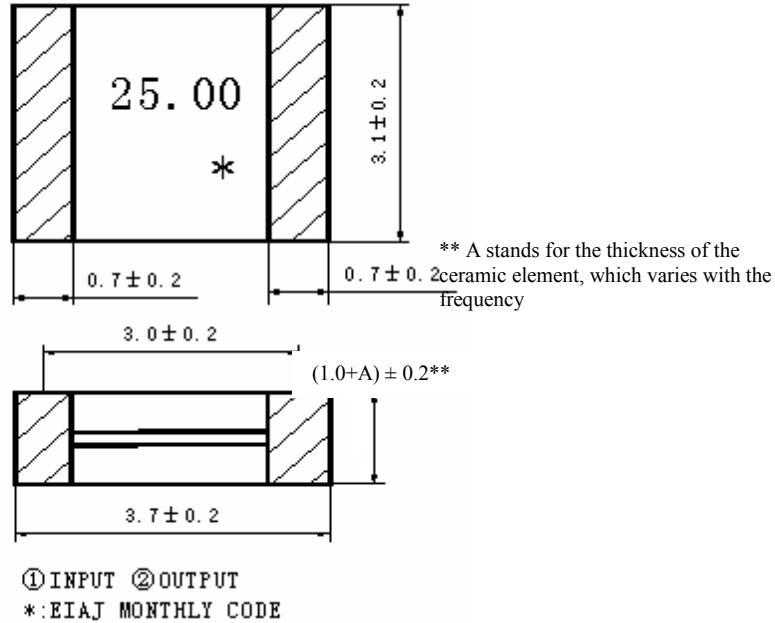

Recommended Land Pattern

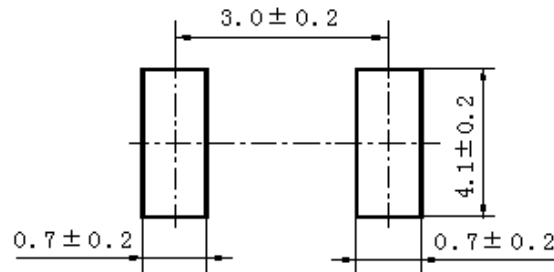

Dimension: mm

REFLOW PROFILE:

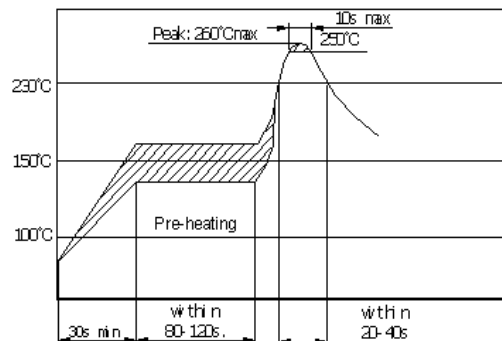

3.7 x 3.1 mm INDUSTRIAL GRADE CERAMIC RESONATOR

AWSZT-CV

RoHS/RoHS II Compliant
Pb in ceramic, exemption (7c-I)



3.7 x 3.1 mm

TAPE & REEL:

T: 1000pcs/Reel

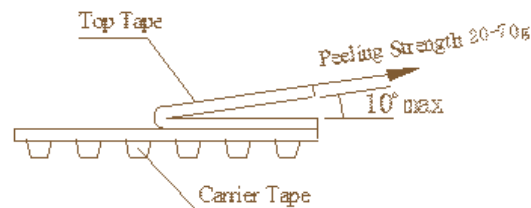
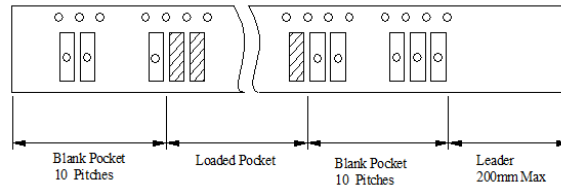
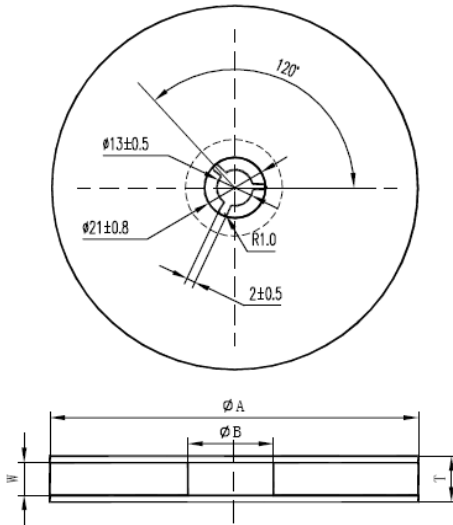

Reel Quantity	ΦA	ΦB	W	T	Pieces per reel	Carrier tape size
1000 (T)	180±3	60 min.	12.4 min	19.4 max	1000 typ.	12

Dimension: mm

Note: upon opening the original packaging, it is recommended that the product be used within 1 year. If the product will not be used within 1 year, it is recommended that the product be re-sealed in airtight packaging according to MSL 1 requirements to maintain solderability.

CAUTION

- (1) Do not apply excess mechanical stress to the component body or terminations. Do not attempt to re-form or bend the components as this will cause damage to the component.
- (2) This component is not hermetically sealed. Do not clean or wash the component.
- (3) Reflow Soldering: Do not use strong acidity flux, such as flux with chlorine content of greater than 0.2wt% during Reflow Soldering.
- (4) Do not expose the component to open flame.
- (5) This specification applies to the functionality of the component as a single unit.
- (6) Storage Conditions: If the product is to be stored for a period greater than 1 year after the Delivery Date, it is recommended that customers confirm the solderability and characteristics for the product prior to use.
- (7) This product is not recommended for use in the following applications: Automotive, Medical, Military, Safety, or any other high-

ATTENTION: Abracon Corporation's products are COTS – Commercial-Off-The-Shelf products; suitable for Commercial, Industrial and, where designated, Automotive Applications. Abracon's products are not specifically designed for Military, Aviation, Aerospace, Life-dependant Medical applications or any application requiring high reliability where component failure could result in loss of life and/or property. For applications requiring high reliability and/or presenting an extreme operating environment, written consent and authorization from Abracon Corporation is required. Please contact Abracon Corporation for more information.

ABRACON IS
ISO9001:2008
CERTIFIED



Visit www.abracon.com for Terms & Conditions of Sale
30332 Esperanza, Rancho Santa Margarita, California 92688
tel 949-546-8000 | fax 949-546-8001 | www.abracon.com

Revised: 05.07.13

Looking for pricing, stock, or lifecycle information?

Click below to explore more details on WIN SOURCE:

 [View AWSZT-8.00CV-T on WIN SOURCE](#)

 [Abracon LLC Information](#)

Optimize Your Supply Chain with WIN SOURCE Solutions

-  Global Sourcing Solution
-  Obsolete Management
-  Cost Control Management
-  Shortage Management
-  Alternative Solution
-  Excess Inventory Management