



**THE DATASHEET OF
ASPI-0704S-330M-T**



SMD SHIELDED POWER INDUCTOR

ASPI-0704S



RoHS
Compliant



7.3 x 7.3 x 4.5mm

FEATURES:

- Superior to be high saturation for surface mounting
- Low resistance to keep power loss minimum
- Magnetic shielded for low radiation
- Compact size
- Ferrite bobbin core

APPLICATIONS:

- Desktop, notebook, servers
- Network hubs, bridges, routers
- XDSL, PBX base stations
- GPS system
- Digital TV, DVD, Modem, setup box
- Battery charger
- Electronic game devices

STANDARD SPECIFICATIONS:

Operating temperature:	-40°C to +125°C (including self-generated heat)
Storage temperature:	+15°C to +28°C
Operating Voltage (maximum):	Voltage across inductor: 400V

Part Number	Inductance	DC Resistance	IDC	Marking
	(μ H)	(Ω)	(A)	
ASPI-0704S-1R0M	1.0	0.020	8.00	1R0
ASPI-0704S-1R5M	1.5	0.018	7.00	1R5
ASPI-0704S-2R2M	2.2	0.028	6.00	2R2
ASPI-0704S-3R3M	3.3	0.032	4.80	3R3
ASPI-0704S-3R9M	3.9	0.035	4.40	3R9
ASPI-0704S-4R7M	4.7	0.038	4.00	4R7
ASPI-0704S-5R6M	5.6	0.040	3.5	5R6
ASPI-0704S-6R8M	6.8	0.045	3.00	6R8
ASPI-0704S-100M	10	0.049	1.84	100
ASPI-0704S-120M	12	0.058	1.71	120
ASPI-0704S-150M	15	0.081	1.47	150
ASPI-0704S-180M	18	0.091	1.31	180
ASPI-0704S-220M	22	0.110	1.23	220
ASPI-0704S-270M	27	0.150	1.12	270
ASPI-0704S-330M	33	0.170	0.96	330
ASPI-0704S-390M	39	0.230	0.91	390
ASPI-0704S-470M	47	0.260	0.88	470
ASPI-0704S-560M	56	0.350	0.75	560
ASPI-0704S-680M	68	0.380	0.69	680
ASPI-0704S-820M	82	0.430	0.61	820
ASPI-0704S-101M	100	0.610	0.60	101
ASPI-0704S-121M	120	0.660	0.52	121
ASPI-0704S-151M	150	0.880	0.46	151
ASPI-0704S-181M	180	0.980	0.42	181
ASPI-0704S-221M	220	1.170	0.36	221
ASPI-0704S-271M	270	1.640	0.34	271
ASPI-0704S-331M	330	1.860	0.32	331
ASPI-0704S-391M	390	2.850	0.29	391
ASPI-0704S-471M	470	3.010	0.26	471
ASPI-0704S-561M	560	3.620	0.23	561
ASPI-0704S-681M	680	4.630	0.22	681
ASPI-0704S-821M	820	5.200	0.20	821
ASPI-0704S-102M	1000	6.000	0.18	102

Test Conditions and Equipment

1. Frequency: 1KHz, 0.25V
2. Rated DC Current: The DC current at which the inductance becomes 25% lower than its initial value or when $\Delta t = 40^\circ\text{C}$, whichever is lower. ($T_a = 25^\circ\text{C}$)
3. L: HP4284A or HP4285A LCR meter
4. DCR: Milli-ohm meter

SMD SHIELDED POWER INDUCTOR

ASPI-0704S



RoHS
Compliant



7.3 x 7.3 x 4.5mm

➤ PART NUMBER IDENTIFICATION:

(Left Blank if Standard)

ASPI-0704S- -

Inductance Code

Please refer to the table above

Packaging

T: Tape and Reel
(1kpcs / reel)

➤ OUTLINE DRAWING:

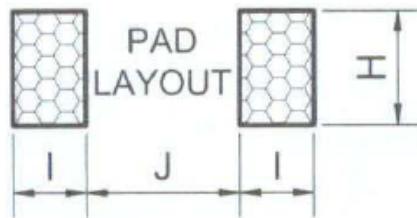
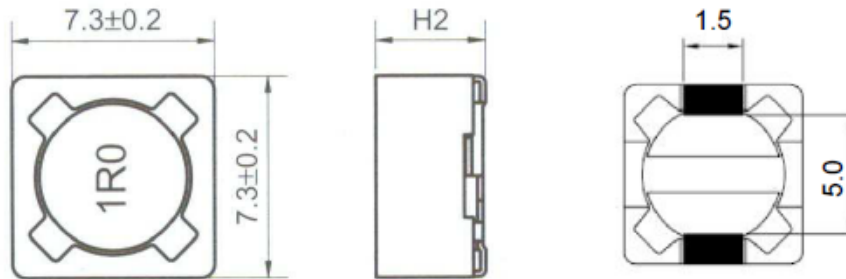

H2	H	I	J
4.5 max	2.2	1.6	4.8

Dimensions: mm

SMD SHIELDED POWER INDUCTOR

ASPI-0704S



RoHS
Compliant



7.3 x 7.3 x 4.5mm

TAPE AND REEL:

Tape and reel (1,000pcs/reel)

DIMENSIONS / SIZE (mm)			PATTERN / SIZE (mm)		
A	B	C	D	E	F
7.3 ± 0.2	7.3 ± 0.2	4.50 Max.	1.6	4.8	2.2

• TAPE DIMENSION & REEL DIMENSION

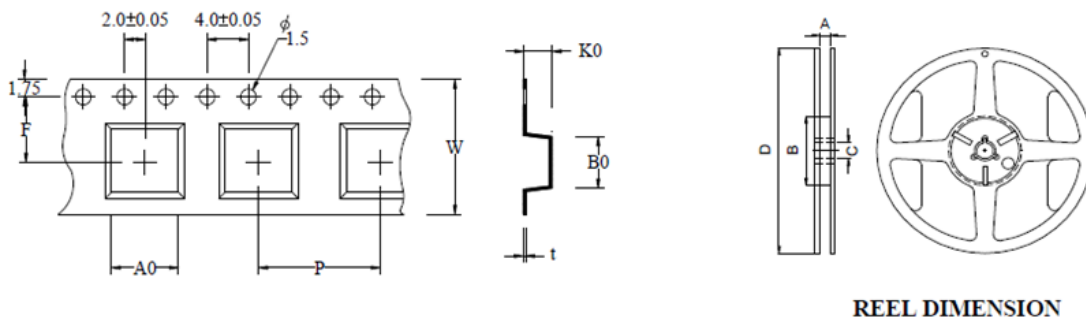

TYPE	TAPE / SIZE (mm)							REEL 13"×16mm			
	Ao	Bo	Ko	P	F	W	t	A	B	C	D
0704	7.7 ± 0.1	7.7 ± 0.1	4.7 ± 0.1	12.0 ± 0.1	7.5 ± 0.1	16 ± 0.3	0.35 ± 0.05	16.5 ± 0.2	100 ± 0.5	13.2 ± 0.3	330 ± 1.0

• PACKAGING QUANTITY

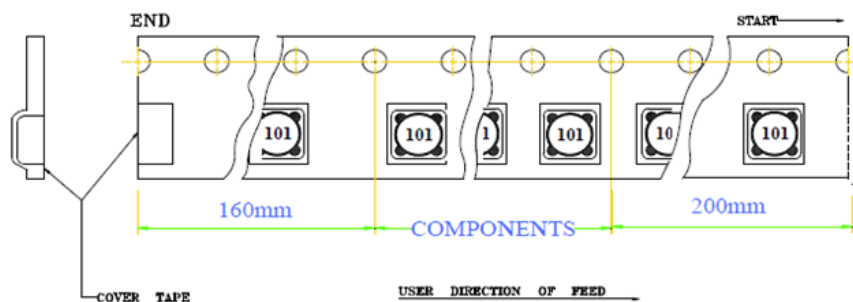

Dimension: mm

SMD SHIELDED POWER INDUCTOR

ASPI-0704S



RoHS
Compliant



7.3 x 7.3 x 4.5mm

REFLOW PROFILE:

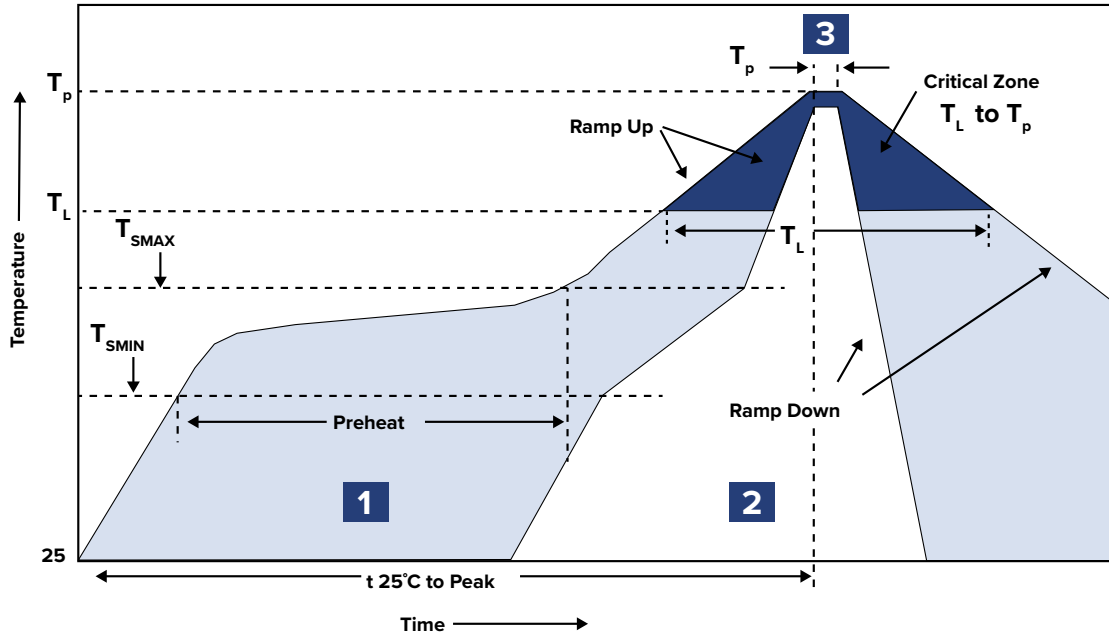



Zone	Description	Temperature	Time
1	Preheat / Soak	T_{SMAX} 150°C ~ 180°C	60 ~ 120 sec.
2	Reflow	T_L 230°C	30 ~ 40 sec.
3	Peak heat	T_P 255°C ~ 265°C	10 sec. MAX

ATTENTION: Abracon LLC's products are COTS – Commercial-Off-The-Shelf products; suitable for Commercial, Industrial and, where designated, Automotive Applications. Abracon's products are not specifically designed for Military, Aviation, Aerospace, Life-dependent Medical applications or any application requiring high reliability where component failure could result in loss of life and/or property. For applications requiring high reliability and/or presenting an extreme operating environment, written consent and authorization from Abracon LLC is required. Please contact Abracon LLC for more information.

Looking for pricing, stock, or lifecycle information?

Click below to explore more details on WIN SOURCE:

-  [View ASPI-0704S-330M-T on WIN SOURCE](#)
-  [Abracon LLC Information](#)

Optimize Your Supply Chain with WIN SOURCE Solutions

-  Global Sourcing Solution
-  Obsolete Management
-  Cost Control Management
-  Shortage Management
-  Alternative Solution
-  Excess Inventory Management