



**THE DATASHEET OF
IP4294CZ10-TBR,115**



Important notice

Dear Customer,

On 7 February 2017 the former NXP Standard Product business became a new company with the tradename **Nexperia**. Nexperia is an industry leading supplier of Discrete, Logic and PowerMOS semiconductors with its focus on the automotive, industrial, computing, consumer and wearable application markets

In data sheets and application notes which still contain NXP or Philips Semiconductors references, use the references to Nexperia, as shown below.

Instead of <http://www.nxp.com>, <http://www.philips.com/> or <http://www.semiconductors.philips.com/>, use <http://www.nexperia.com>

Instead of sales.addresses@www.nxp.com or sales.addresses@www.semiconductors.philips.com, use salesaddresses@nexperia.com (email)

Replace the copyright notice at the bottom of each page or elsewhere in the document, depending on the version, as shown below:

- © NXP N.V. (year). All rights reserved or © Koninklijke Philips Electronics N.V. (year). All rights reserved

Should be replaced with:

- © **Nexperia B.V. (year). All rights reserved.**

If you have any questions related to the data sheet, please contact our nearest sales office via e-mail or telephone (details via salesaddresses@nexperia.com). Thank you for your cooperation and understanding,

Kind regards,

Team Nexperia



IP4294CZ10-TBR

ESD protection for ultra high-speed interfaces

Rev. 4 — 1 November 2013

Product data sheet

1. Product profile

1.1 General description

The device is designed to protect high-speed interfaces such as SuperSpeed USB, High-Definition Multimedia Interface (HDMI), DisplayPort, external Serial Advanced Technology Attachment (eSATA) and Low Voltage Differential Signaling (LVDS) interfaces against ElectroStatic Discharge (ESD).

The device includes four high-level ESD protection diode structures for ultra high-speed signal lines and is encapsulated in a leadless small DFN2510A-10 (SOT1176-1) plastic package.

All signal lines are protected by a special diode configuration offering ultra low line capacitance of only 0.5 pF. These diodes utilize a unique snap-back structure in order to provide protection to downstream components from ESD voltages up to ± 10 kV contact exceeding IEC 61000-4-2, level 4.

1.2 Features and benefits

- System ESD protection for USB 2.0 and SuperSpeed USB 3.0, HDMI, DisplayPort, eSATA and LVDS
- All signal lines with integrated rail-to-rail clamping diodes for downstream ESD protection of ± 10 kV exceeding IEC 61000-4-2, level 4
- Matched 0.5 mm trace spacing
- Signal lines with ≤ 0.05 pF matching capacitance between signal pairs
- Line capacitance of only 0.5 pF for each channel
- Design-friendly 'pass-through' signal routing

1.3 Applications

The device is designed for high-speed receiver and transmitter port protection:

- TVs and monitors
- DVD recorders and players
- Notebooks, main board graphic cards and ports
- Set-top boxes and game consoles



2. Pinning information

Table 1. Pinning

Pin	Symbol	Description	Simplified outline	Graphic symbol
1	CH1	channel 1 ESD protection	<p>Transparent top view</p>	
2	CH2	channel 2 ESD protection		
3	GND	ground		
4	CH3	channel 3 ESD protection		
5	CH4	channel 4 ESD protection		
6	n.c.	not connected		
7	n.c.	not connected		
8	GND	ground		
9	n.c.	not connected		
10	n.c.	not connected		

3. Ordering information

Table 2. Ordering information

Type number	Package		Version
	Name	Description	
IP4294CZ10-TBR	DFN2510A-10	plastic extremely thin small outline package; no leads; 10 terminals; body 1 × 2.5 × 0.5 mm	SOT1176-1

4. Marking

Table 3. Marking codes

Type number	Marking code
IP4294CZ10-TBR	94

5. Limiting values

Table 4. Limiting values

In accordance with the Absolute Maximum Rating System (IEC 60134).

Symbol	Parameter	Conditions	Min	Max	Unit
V_I	input voltage		-0.5	+5.5	V
V_{ESD}	electrostatic discharge voltage	IEC 61000-4-2, level 4 [1]			
		contact discharge	-10	+10	kV
		air discharge	-15	+15	kV
T_{amb}	ambient temperature		-40	+85	°C
T_{stg}	storage temperature		-55	+125	°C

[1] All pins to ground.

6. Characteristics

Table 5. Characteristics

$T_{amb} = 25\text{ }^{\circ}\text{C}$ unless otherwise specified.

Symbol	Parameter	Conditions	Min	Typ	Max	Unit
V_{BR}	breakdown voltage	$I_I = 1\text{ mA}$	6	-	-	V
I_{LR}	reverse leakage current	per channel; $V_I = 3\text{ V}$	-	-	1	μA
V_F	forward voltage	$I_I = 1\text{ mA}$	-	0.7	-	V
C_{line}	line capacitance	$f = 1\text{ MHz}$; $V_I = 3.3\text{ V}$	[1]	0.5	0.6	pF
ΔC_{line}	line capacitance difference	$f = 1\text{ MHz}$; $V_I = 3.3\text{ V}$	[1]	0.05	-	pF
r_{dyn}	dynamic resistance	surge	[2]			
		positive transient	-	0.36	-	Ω
		negative transient	-	0.35	-	Ω
		TLP	[3]			
		positive transient	-	0.41	-	Ω
		negative transient	-	0.34	-	Ω
V_{CL}	clamping voltage	$I_{PP} = 4\text{ A}$	[2]			
		positive transient	-	4.1	-	V
		$I_{PP} = -4\text{ A}$	[2]			
		negative transient	-	-2.2	-	V

[1] This parameter is guaranteed by design.

[2] According to IEC 61000-4-5 (8/20 μs current waveform).

[3] 100 ns Transmission Line Pulse (TLP); 50 Ω ; pulser at 80 ns.

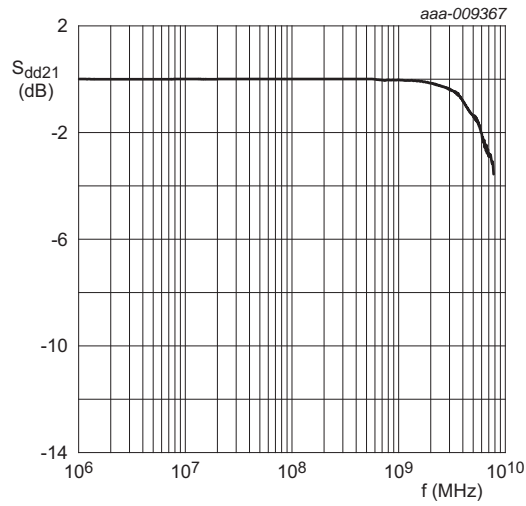

differential mode

Fig 1. Insertion loss; typical values

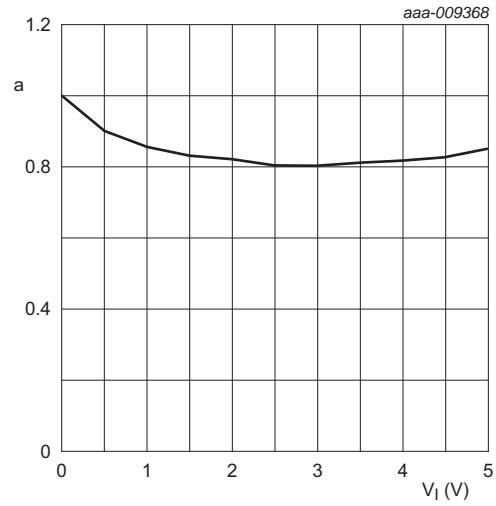

$$a = \frac{C_{line}}{C_{line}(V_I = 0 \text{ V})}$$

Fig 2. Relative capacitance as a function of input voltage; typical values

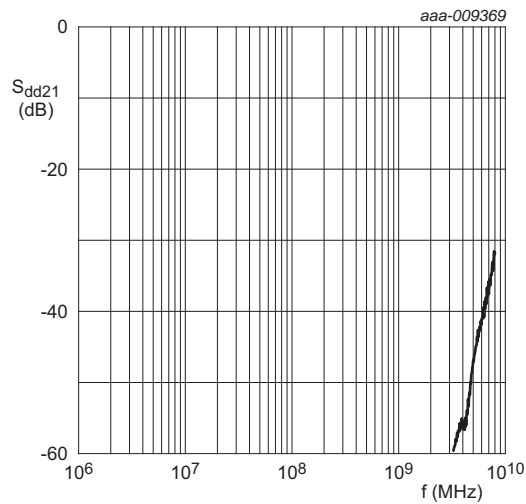

Sdd21 normalized to 100 Ω;
differential pairs CH1/CH2 versus CH3/CH4

Fig 3. Crosstalk; typical values

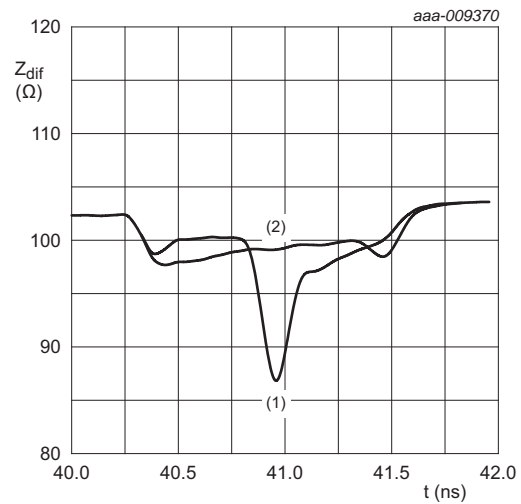

$t_r = 200 \text{ ps}$; differential pair CH1 + CH2

- (1) IP4294CZ10-TBR on reference board
- (2) Reference board without device under test (DUT)

Fig 4. Differential Time Domain Reflectometer (TDR) plot; typical values

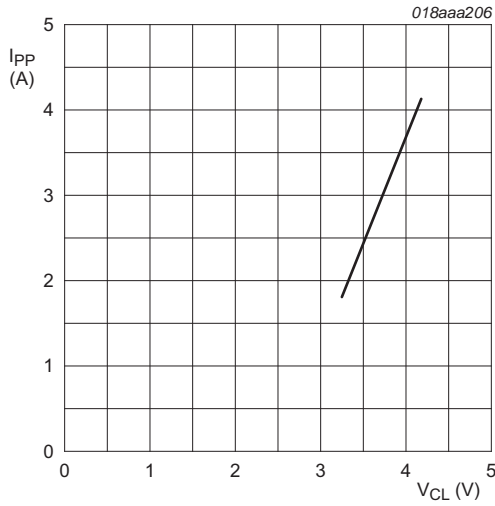

IEC 61000-4-5; $t_p = 8/20 \mu s$; positive pulse

Fig 5. Dynamic resistance with positive clamping; typical values

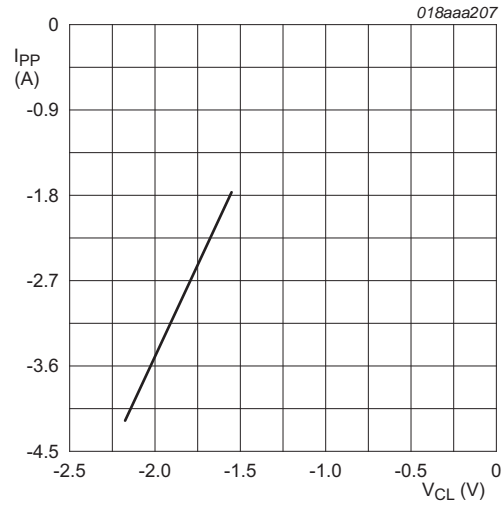

IEC 61000-4-5; $t_p = 8/20 \mu s$; negative pulse

Fig 6. Dynamic resistance with negative clamping; typical values

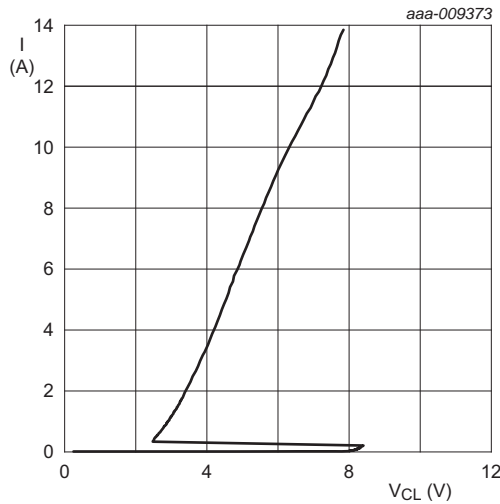

$t_p = 100 ns$; Transmission Line Pulse (TLP)

Fig 7. Dynamic resistance with positive clamping; typical values

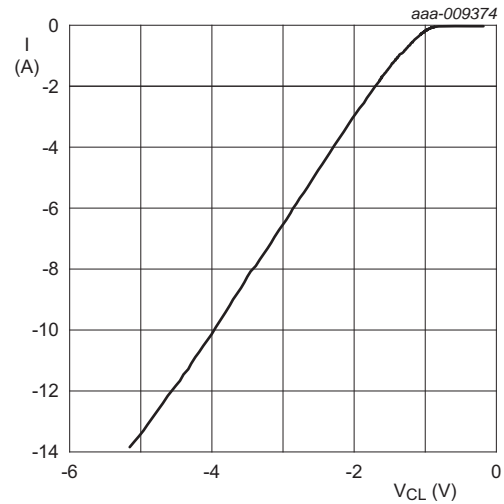

$t_p = 100 ns$; Transmission Line Pulse (TLP)

Fig 8. Dynamic resistance with negative clamping; typical values

The device uses an advanced clamping structure showing a negative dynamic resistance. This snap-back behavior strongly reduces the clamping voltage to the system behind the ESD protection during an ESD event. Do not connect unlimited DC current sources to the data lines to avoid keeping the ESD protection device in snap-back state after exceeding breakdown voltage (due to an ESD pulse for instance).

7. Application information

The device is designed to provide high-level ESD protection for high-speed serial data buses such as HDMI, DisplayPort, eSATA and LVDS data lines.

When designing the Printed-Circuit Board (PCB), give careful consideration to impedance matching and signal coupling. Do not connect the signal lines to unlimited current sources like, for example, a battery.

A basic application diagram for the ESD protection of an HDMI interface is shown in [Figure 9](#).

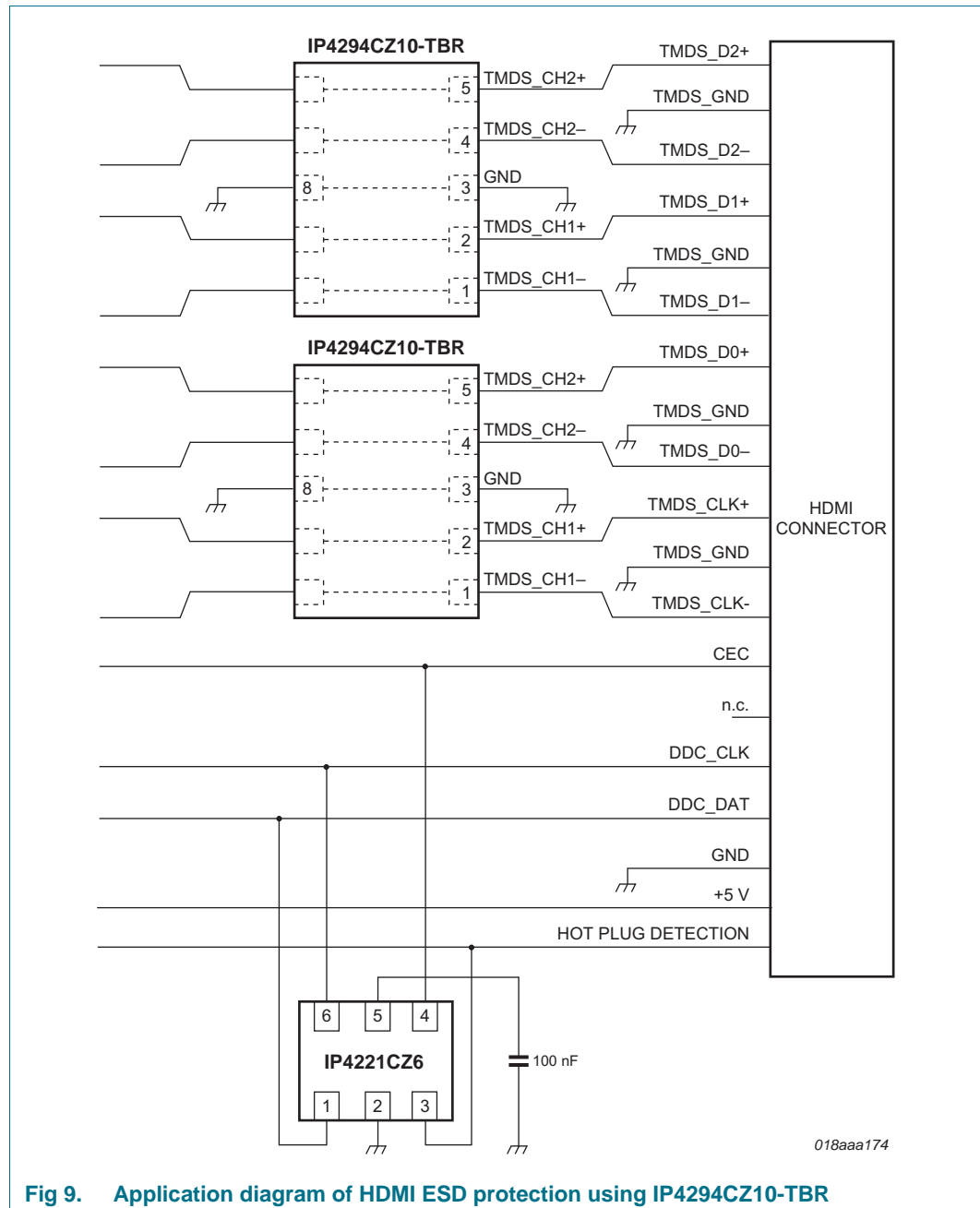

Fig 9. Application diagram of HDMI ESD protection using IP4294CZ10-TBR

8. Package outline

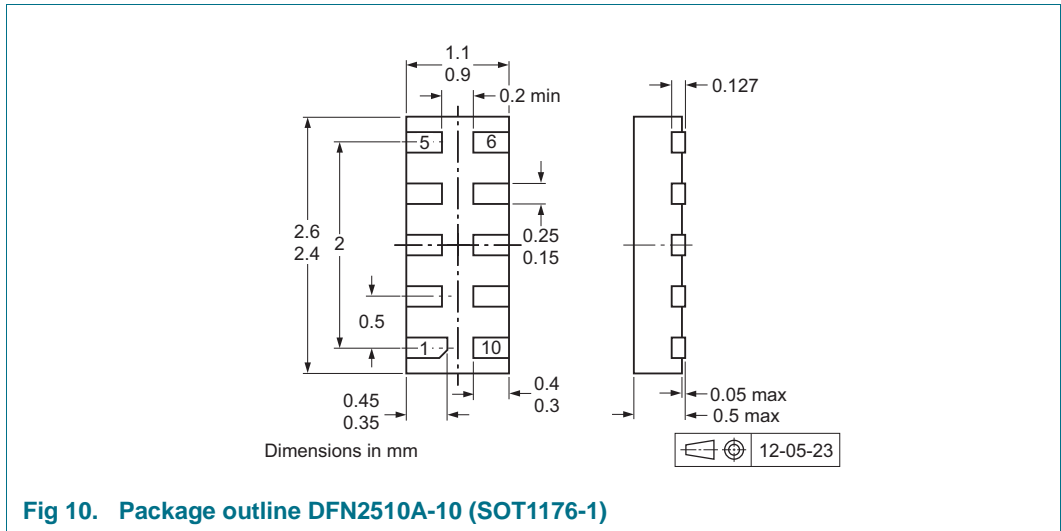

Fig 10. Package outline DFN2510A-10 (SOT1176-1)

9. Soldering

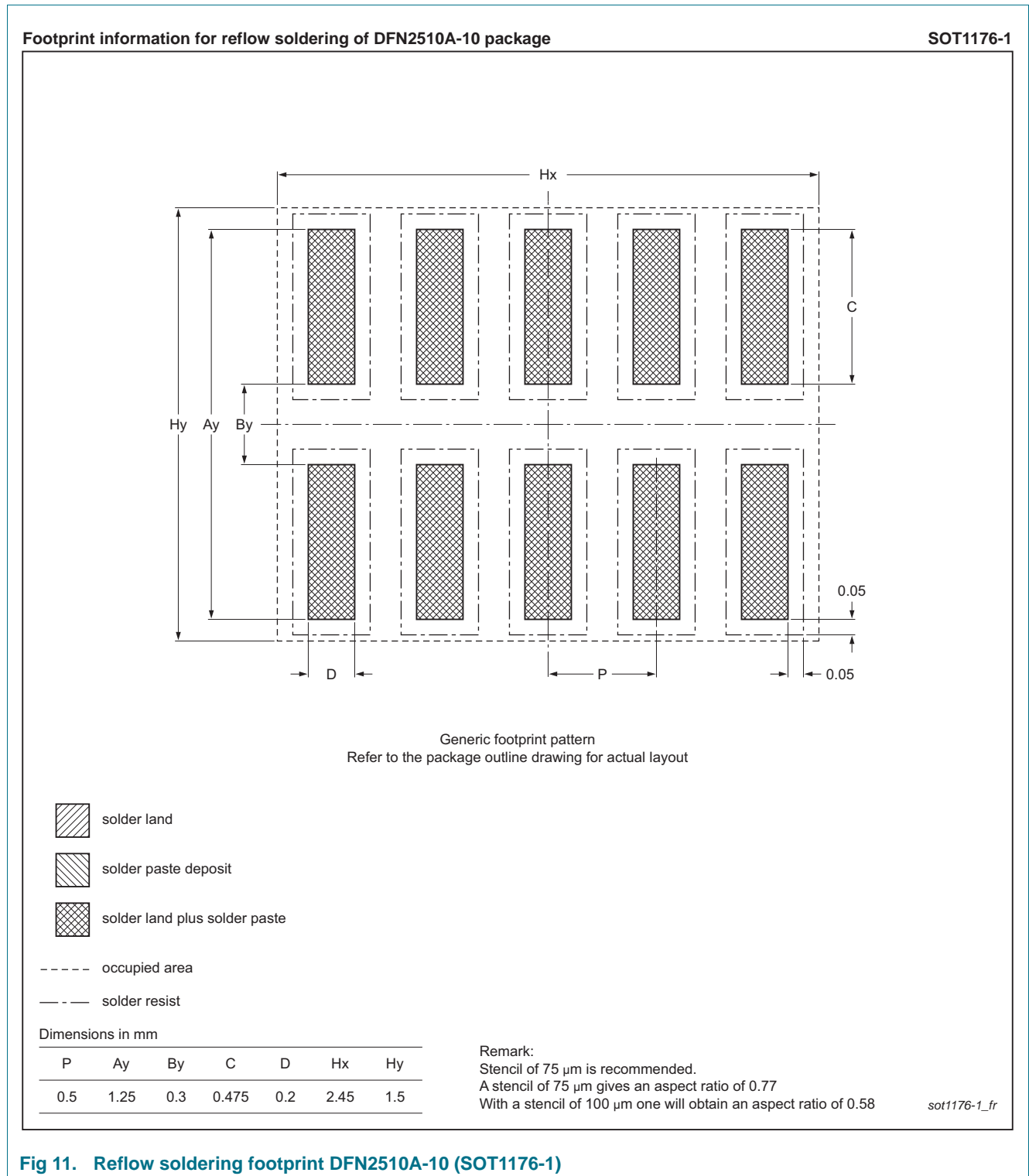

Fig 11. Reflow soldering footprint DFN2510A-10 (SOT1176-1)

10. Revision history

Table 6. Revision history

Document ID	Release date	Data sheet status	Change notice	Supersedes
IP4294CZ10-TBR v.4	20131101	Product data sheet	-	IP4294CZ10-TBR v.3
Modifications:	• Measurements updated after silicon manufacturing transfer.			
IP4294CZ10-TBR v.3	20120224	Product data sheet	-	IP4294CZ10-TBR v.2
IP4294CZ10-TBR v.2	20120229	Preliminary data sheet	-	IP4294CZ10-TBR v.1
IP4294CZ10-TBR v.1	20111125	Preliminary data sheet	-	-

11. Legal information

11.1 Data sheet status

Document status ^{[1][2]}	Product status ^[3]	Definition
Objective [short] data sheet	Development	This document contains data from the objective specification for product development.
Preliminary [short] data sheet	Qualification	This document contains data from the preliminary specification.
Product [short] data sheet	Production	This document contains the product specification.

[1] Please consult the most recently issued document before initiating or completing a design.

[2] The term 'short data sheet' is explained in section "Definitions".

[3] The product status of device(s) described in this document may have changed since this document was published and may differ in case of multiple devices. The latest product status information is available on the Internet at URL <http://www.nxp.com>.

11.2 Definitions

Draft — The document is a draft version only. The content is still under internal review and subject to formal approval, which may result in modifications or additions. NXP Semiconductors does not give any representations or warranties as to the accuracy or completeness of information included herein and shall have no liability for the consequences of use of such information.

Short data sheet — A short data sheet is an extract from a full data sheet with the same product type number(s) and title. A short data sheet is intended for quick reference only and should not be relied upon to contain detailed and full information. For detailed and full information see the relevant full data sheet, which is available on request via the local NXP Semiconductors sales office. In case of any inconsistency or conflict with the short data sheet, the full data sheet shall prevail.

Product specification — The information and data provided in a Product data sheet shall define the specification of the product as agreed between NXP Semiconductors and its customer, unless NXP Semiconductors and customer have explicitly agreed otherwise in writing. In no event however, shall an agreement be valid in which the NXP Semiconductors product is deemed to offer functions and qualities beyond those described in the Product data sheet.

11.3 Disclaimers

Limited warranty and liability — Information in this document is believed to be accurate and reliable. However, NXP Semiconductors does not give any representations or warranties, expressed or implied, as to the accuracy or completeness of such information and shall have no liability for the consequences of use of such information. NXP Semiconductors takes no responsibility for the content in this document if provided by an information source outside of NXP Semiconductors.

In no event shall NXP Semiconductors be liable for any indirect, incidental, punitive, special or consequential damages (including - without limitation - lost profits, lost savings, business interruption, costs related to the removal or replacement of any products or rework charges) whether or not such damages are based on tort (including negligence), warranty, breach of contract or any other legal theory.

Notwithstanding any damages that customer might incur for any reason whatsoever, NXP Semiconductors' aggregate and cumulative liability towards customer for the products described herein shall be limited in accordance with the *Terms and conditions of commercial sale* of NXP Semiconductors.

Right to make changes — NXP Semiconductors reserves the right to make changes to information published in this document, including without limitation specifications and product descriptions, at any time and without notice. This document supersedes and replaces all information supplied prior to the publication hereof.

Suitability for use — NXP Semiconductors products are not designed, authorized or warranted to be suitable for use in life support, life-critical or safety-critical systems or equipment, nor in applications where failure or malfunction of an NXP Semiconductors product can reasonably be expected to result in personal injury, death or severe property or environmental damage. NXP Semiconductors and its suppliers accept no liability for inclusion and/or use of NXP Semiconductors products in such equipment or applications and therefore such inclusion and/or use is at the customer's own risk.

Applications — Applications that are described herein for any of these products are for illustrative purposes only. NXP Semiconductors makes no representation or warranty that such applications will be suitable for the specified use without further testing or modification.

Customers are responsible for the design and operation of their applications and products using NXP Semiconductors products, and NXP Semiconductors accepts no liability for any assistance with applications or customer product design. It is customer's sole responsibility to determine whether the NXP Semiconductors product is suitable and fit for the customer's applications and products planned, as well as for the planned application and use of customer's third party customer(s). Customers should provide appropriate design and operating safeguards to minimize the risks associated with their applications and products.

NXP Semiconductors does not accept any liability related to any default, damage, costs or problem which is based on any weakness or default in the customer's applications or products, or the application or use by customer's third party customer(s). Customer is responsible for doing all necessary testing for the customer's applications and products using NXP Semiconductors products in order to avoid a default of the applications and the products or of the application or use by customer's third party customer(s). NXP does not accept any liability in this respect.

Limiting values — Stress above one or more limiting values (as defined in the Absolute Maximum Ratings System of IEC 60134) will cause permanent damage to the device. Limiting values are stress ratings only and (proper) operation of the device at these or any other conditions above those given in the Recommended operating conditions section (if present) or the Characteristics sections of this document is not warranted. Constant or repeated exposure to limiting values will permanently and irreversibly affect the quality and reliability of the device.

Terms and conditions of commercial sale — NXP Semiconductors products are sold subject to the general terms and conditions of commercial sale, as published at <http://www.nxp.com/profile/terms>, unless otherwise agreed in a valid written individual agreement. In case an individual agreement is concluded only the terms and conditions of the respective agreement shall apply. NXP Semiconductors hereby expressly objects to applying the customer's general terms and conditions with regard to the purchase of NXP Semiconductors products by customer.

No offer to sell or license — Nothing in this document may be interpreted or construed as an offer to sell products that is open for acceptance or the grant, conveyance or implication of any license under any copyrights, patents or other industrial or intellectual property rights.

Export control — This document as well as the item(s) described herein may be subject to export control regulations. Export might require a prior authorization from competent authorities.

Quick reference data — The Quick reference data is an extract of the product data given in the Limiting values and Characteristics sections of this document, and as such is not complete, exhaustive or legally binding.

Non-automotive qualified products — Unless this data sheet expressly states that this specific NXP Semiconductors product is automotive qualified, the product is not suitable for automotive use. It is neither qualified nor tested in accordance with automotive testing or application requirements. NXP Semiconductors accepts no liability for inclusion and/or use of non-automotive qualified products in automotive equipment or applications.

In the event that customer uses the product for design-in and use in automotive applications to automotive specifications and standards, customer (a) shall use the product without NXP Semiconductors' warranty of the

product for such automotive applications, use and specifications, and (b) whenever customer uses the product for automotive applications beyond NXP Semiconductors' specifications such use shall be solely at customer's own risk, and (c) customer fully indemnifies NXP Semiconductors for any liability, damages or failed product claims resulting from customer design and use of the product for automotive applications beyond NXP Semiconductors' standard warranty and NXP Semiconductors' product specifications.

Translations — A non-English (translated) version of a document is for reference only. The English version shall prevail in case of any discrepancy between the translated and English versions.

11.4 Trademarks

Notice: All referenced brands, product names, service names and trademarks are the property of their respective owners.

12. Contact information

For more information, please visit: <http://www.nxp.com>

For sales office addresses, please send an email to: salesaddresses@nxp.com

13. Contents

1	Product profile	1
1.1	General description	1
1.2	Features and benefits	1
1.3	Applications	1
2	Pinning information	2
3	Ordering information	2
4	Marking	2
5	Limiting values	2
6	Characteristics	3
7	Application information	6
8	Package outline	7
9	Soldering	8
10	Revision history	9
11	Legal information	10
11.1	Data sheet status	10
11.2	Definitions	10
11.3	Disclaimers	10
11.4	Trademarks	11
12	Contact information	11
13	Contents	12

Please be aware that important notices concerning this document and the product(s) described herein, have been included in section 'Legal information'.

© NXP B.V. 2013.

All rights reserved.

For more information, please visit: <http://www.nxp.com>



For sales office addresses, please send an email to: salesaddresses@nxp.com

Date of release: 1 November 2013

Document identifier: IP4294CZ10-TBR

Looking for pricing, stock, or lifecycle information?

Click below to explore more details on WIN SOURCE:

-  [View IP4294CZ10-TBR,115 on WIN SOURCE](#)
-  [NXP / Nexperia Information](#)

Optimize Your Supply Chain with WIN SOURCE Solutions

-  Global Sourcing Solution
-  Obsolete Management
-  Cost Control Management
-  Shortage Management
-  Alternative Solution
-  Excess Inventory Management