



**THE DATASHEET OF
MD-60PL100**



SERIES: MD-PL100 | **DESCRIPTION:** MINI DIN CONNECTOR**FEATURES**

- panel mount
- 10 cm lead wires
- 3-8 pins

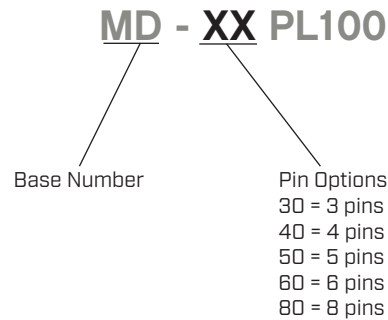
**PART NUMBER KEY****SPECIFICATIONS**

parameter	conditions/description	min	typ	max	units
rated input voltage			100 12		Vac Vdc
rated input current	at 100 Vac at 12 Vdc			1 2	A A
contact resistance				30	mΩ
insulation resistance	at 250 Vdc	50			MΩ
voltage withstand	for 1 minute			250	Vac
insertion force		0.8		6.5	kg
withdrawal force		0.8		4.5	kg
operating temperature		-25		80	°C
flammability rating	UL94V-0				
RoHS	yes				

MECHANICAL DRAWINGS

units: mm
 units: mm
 tolerance: ±0.3 mm
 unless otherwise noted

ITEM	DESCRIPTION	MATERIAL	PLATING/COLOR
1	body	PBT [UL94V-0]	black
2	earth terminal	brass	tin
3	terminals	phosphor bronze	tin
4	wire	UL1061/AWG 26	

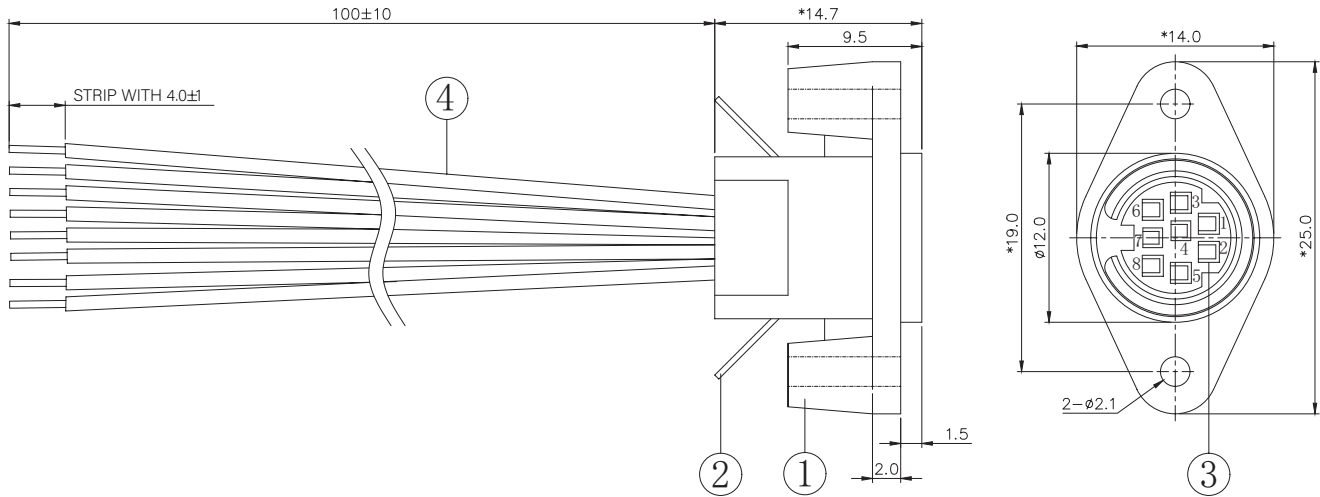

MD-30PL100

MD-40PL100

MD-50PL100

MD-60PL100

MD-80PL100

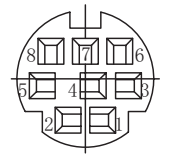
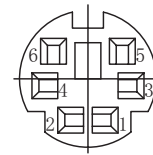
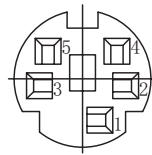
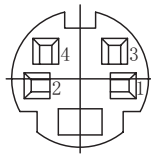
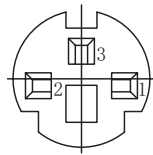

PIN	Wire Color	Wire Color	Wire Color	Wire Color	Wire Color
1	black	black	brown	brown	brown
2	green	green	black	white	white
3	orange	yellow	green	black	black
4		red	yellow	green	blue
5			red	yellow	green
6				red	yellow
7					orange
8					red

REVISION HISTORY

rev.	description	date
1.0	initial release	02/23/2006
1.01	new template applied	03/07/2012
1.02	updated datasheet	08/25/2017
1.03	updated housing, brand update	10/14/2019
1.04	changed front notch size of MD-30PL100	12/15/2021
1.05	modified design, changed factory	02/17/2022
1.06	logo, datasheet style update	08/05/2022
1.07	CUI Devices rebranded to Same Sky	09/12/2024

The revision history provided is for informational purposes only and is believed to be accurate.



Same Sky offers a one (1) year limited warranty. Complete warranty information is listed on our website.

Same Sky reserves the right to make changes to the product at any time without notice. Information provided by Same Sky is believed to be accurate and reliable. However, no responsibility is assumed by Same Sky for its use, nor for any infringements of patents or other rights of third parties which may result from its use.

Same Sky products are not authorized or warranted for use as critical components in equipment that requires an extremely high level of reliability. A critical component is any component of a life support device or system whose failure to perform can be reasonably expected to cause the failure of the life support device or system, or to affect its safety or effectiveness.

[sameskydevices.com](https://www.sameskydevices.com)

Looking for pricing, stock, or lifecycle information?

Click below to explore more details on WIN SOURCE:

 [View MD-60PL100 on WIN SOURCE](#)

 [Same Sky Information](#)

Optimize Your Supply Chain with WIN SOURCE Solutions

-  Global Sourcing Solution
-  Obsolete Management
-  Cost Control Management
-  Shortage Management
-  Alternative Solution
-  Excess Inventory Management