



**THE DATASHEET OF
IPD65R600E6BTMA1**



MOSFET

Metall Oxide Semiconductor Field Effect Transistor

CoolMOS E6

650V CoolMOS™ E6 Power Transistor
IPx65R600E6

Data Sheet

Rev. 2.3, 2018-02-28

1 Description

CoolMOS™ is a revolutionary technology for high voltage power MOSFETs, designed according to the superjunction (SJ) principle and pioneered by Infineon Technologies. CoolMOS™ DE series combines the experience of the leading SJ MOSFET supplier with high class innovation. The resulting devices provide all benefits of a fast switching SJ MOSFET while not sacrificing ease of use. Extremely low switching and conduction losses make switching applications even more efficient, more compact, lighter, and cooler.

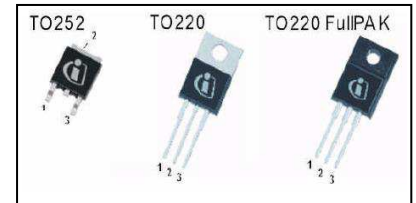

Features

- Extremely low losses due to very low $F O M R_{dson} \cdot Q_g$ and E_{oss}
- Very high commutation ruggedness
- Easy to use/drive
- JEDEC¹⁾ qualified, Pb-free plating, available in Halogen free mold compound²⁾

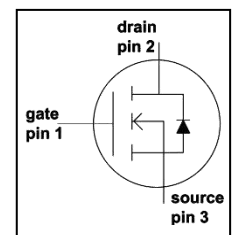

Applications

PFC stages, hard switching PWM stages and resonant switching PWM stages e.g. PC Silverbox, Adapter, LCD & PDP TV, Lightning, Server, Telecom and UPS.

Please note: For MOSFET paralleling the use of ferrite beads on the gate or separate totem poles is generally recommended.



Table 1 Key Performance Parameters

Parameter	Value	Unit
$V_{DS} @ T_{j, max}$	700	V
$R_{DS(on), max}$	0.6	Ω
Q_G, typ	23	nC
$I_D, pulse$	18	A
$E_{oss} @ 400V$	2	μJ
Body diode di/dt	500	A/ μs

Type / Ordering Code	Package	Marking	Related links
IPD65R600E6	PG-TO252	65E6600	IFX CoolMOS Webpage IFX Design tools
IPP65R600E6	PG-TO220		
IPA65R600E6	PG-TO220 FullPAK		

1) J-STD20 and JESD22

2) For PG-TO252: non-Halogen free (OPN: IPD65R600E6BT); Halogen free (OPN: IPD65R600E6AT)

Table of Contents

1	Description.....	2
2	Maximum ratings.....	4
3	Thermal characteristics.....	5
4	Electrical characteristics.....	5
5	Electrical characteristics diagrams.....	8
6	Test circuits.....	13
7	Package outlines.....	14
8	Revision History.....	17

2 Maximum ratings

At $T_j = 25\text{ °C}$, unless otherwise specified.

Table 2 Maximum ratings

Parameter	Symbol	Values			Unit	Note/Test Condition
		Min.	Typ.	Max.		
Continuous drain current ¹⁾	I_D	–	–	7.3	A	$T_C = 25\text{ °C}$
		–	–	4.6		$T_C = 100\text{ °C}$
Pulsed drain current ²⁾	$I_{D, pulse}$	–	–	18		$T_C = 25\text{ °C}$
Averlanche energy, single pulse	E_{AS}	–	–	142	mJ	$I_D = 1.3\text{ A}; V_{DD} = 50\text{ V};$ $T_C = 25\text{ °C}$ (see Table 11)
Averlanche energy, repetitive	E_{AR}	–	–	0.21		$I_D = 1.3\text{ A}, V_{DD} = 50\text{ V}$
Avalanche current, repetitive	I_{AR}	–	–	1.3	A	
MOSFET dv/dt ruggedness	dv/dt	–	–	50	V/ns	$V_{DS} = 0 \dots 480\text{ V}$
Gate source voltage	V_{GS}	-20	–	20	V	static
		-30		30		AC ($f > 1\text{ Hz}$)
Power dissipation for Non FullPAK	P_{tot}	–	–	63	W	$T_C = 25\text{ °C}$
Power dissipation for FullPAK	P_{tot}	–	–	28	W	$T_C = 25\text{ °C}$
Operating and storage temperature	T_j, T_{stg}	-55	–	150	°C	
Mounting torque TO-220		–	–	60	Ncm	M3 and M3.5 screws
Mounting torque TO-220 FullPAK		–	–	50		M2.5 Screws
Continous diode forward current	I_S	–	–	6.3	A	$T_C = 25\text{ °C}$
Diode pulse current ²⁾	$I_{S, pulsed}$	–	–	18	A	$T_C = 25\text{ °C}$
Reverse diode dv/dt ³⁾	dv/dt	–	–	15	V/ns	$V_{DS} = 0 \dots 480\text{ V}, I_{SD} \leq I_D,$
Maximum diode commutation speed ³⁾	di/dt			500	A/ μs	$T_C = 125\text{ °C}$ (see table 22)

1) Limited by $T_{j, max}$. Maximum duty cycle $D=0.75$

2) Pulse width t_p limited by $T_{j, max}$

3) Identical low side and high side switch with identical R_{θ}

3 Thermal characteristics

Table 3 Thermal characteristics TO-220 (IPP65R600E6)

Parameter	Symbol	Values			Unit	Note/Test Condition
		Min.	Typ.	Max.		
Thermal resistance, junction-case	R_{thJC}	–	–	2.0	°C/W	leaded
Thermal resistance, junction-ambient	R_{thJA}	–	–	62		
Soldering temperature, wavesoldering only allowed at leads	T_{sold}	–	–	260	°C	1.6mm (0.063 in.) from case for 10 s

Table 4 Thermal characteristics TO-220 FullPAK (IPA65R600E6)

Parameter	Symbol	Values			Unit	Note/Test Condition
		Min.	Typ.	Max.		
Thermal resistance, junction-case	R_{thJC}	–	–	4.5	°C/W	leaded
Thermal resistance, junction-ambient	R_{thJA}	–	–	80		
Soldering temperature, wavesoldering only allowed at leads	T_{sold}	–	–	260	°C	1.6mm (0.063 in.) from case for 10 s

Table 5 Thermal characteristics TO-252 (IPD65R600E6)

Parameter	Symbol	Values			Unit	Note/Test Condition
		Min.	Typ.	Max.		
Thermal resistance, junction-case	R_{thJC}	–	–	2.0	°C/W	SMD version, device on PCB, minimal footprint
Thermal resistance, junction-ambient	R_{thJA}	–	–	62		
			35			
Soldering temperature, wave- & reflowsoldering only allowed	T_{sold}	–	–	260	°C	Reflow MSL1

1) Device on 40mm*40mm*1.5 epoxy PCB FR4 with 6cm² (one layer, 70µm thick) copper area for drain connection. PCB is vertical without air stream cooling.

4 Electrical characteristics

Electrical characteristics, at $T_j=25^\circ\text{C}$, unless otherwise specified

Table 6 Static characteristics

Parameter	Symbol	Values			Unit	Note/Test Condition
		Min.	Typ.	Max.		
Drain-source Breakdown voltage	$V_{(BR)DSS}$	650	–	–	V	$V_{GS}=0V, I_D=1.0mA$
Gate threshold voltage	$V_{GS(th)}$	2.5	3	3.5		$V_{DS}=V_{GS}, I_D=0.21mA$
Zero gate Voltage drain current	I_{DSS}	–	–	1	μA	$V_{DS}=600V, V_{GS}=0V,$ $T_f=25^\circ\text{C}$
		–	10	–		$V_{DS}=600V, V_{GS}=0V,$ $T_f=150^\circ\text{C}$
Gate- source leakage current	I_{GSS}	–	–	100	nA	$V_{GS}=20V, V_{DS}=0V$
Drain- source on- state resistance	$R_{DS(on)}$	–	0.54	0.6	Ω	$V_{GS}=10V, I_D=2.1A,$ $T_f=25^\circ\text{C}$
		–	1.40	–		$V_{GS}=10V, I_D=2.1A,$ $T_f=150^\circ\text{C}$
Gate resistance	R_G	–	10.5	–	Ω	$f=1\text{MHz}, \text{open drain}$

Table7 Dynamic characteristics

Parameter	Symbol	Values			Unit	Note/Test Condition	
		Min.	Typ.	Max.			
Input capacitance	C_{iss}	–	440	–	pF	$V_{GS}=0V, V_{DS}=100V,$ $f=1\text{MHz}$	
Output capacitance	C_{oss}	–	30	–			
Effective output capacitance, energy related ¹⁾	$C_{o(er)}$	–	21	–			$V_{GS}=0V,$ $V_{DS}=0\dots480V$
Effective output capacitance, time related ²⁾	$C_{o(tr)}$	–	88	–			$I_D=const$ $V_{GS}=0V, V_{DS}=0\dots480V$
Turn- on delay time	$t_{d(on)}$	–	10	–	ns	$V_{DD}=400V$ $V_{GS}=13V, I_D=3.2A,$ $R_G=6.8\Omega$ (see table 20)	
Rise time	t_r	–	8	–			
Turn- off delay time	$t_{d(off)}$	–	64	–			
Fall time	t_f	–	11	–			

1) $C_{o(er)}$ is a fixed capacitance that gives the same stored energy as C_{oss} while V_{DS} is rising from 0 to 80% $V_{(BR)DSS}$

2) $C_{o(tr)}$ is a fixed capacitance that gives the same charging time as C_{oss} while V_{DS} is rising from 0 to 80% $V_{(BR)DSS}$

Table 8 Gate charge characteristics

Parameter	Symbol	Values			Unit	Note/Test Condition
		Min.	Typ.	Max.		
Gate to source charge	Q_{GS}	–	2.75	–	nC	$V_{DD}=480V, I_D=3.2A,$ $V_{GS}=0$ to 10 V
Gate to drain charge	Q_{GD}	–	12	–		
Gate charge, total	Q_G	–	23	–		
Gate plateau voltage	$V_{plateau}$	–	5.5	–	V	

Table 8 Reverse diode characteristics

Parameter	Symbol	Values			Unit	Note/Test Condition
		Min.	Typ.	Max.		
Diode forward voltage	V_{SD}	–	0.9	–	V	$V_{GS}=0V, I_F=3.2A,$ $T_J=25^\circ C$
Reverse recovery time	t_{rr}	–	270	–	ns	$V_R=400V, I_F=3.2A,$ $diF/dt=100A/\mu s$ (see table 22)
Reverse recovery charge	Q_{rr}	–	2.0	–	nC	
Peak reverse recovery current	I_{rrm}	–	13	–	A	

5 Electrical characteristics diagrams

Table 10

Power dissipation Non FullPAK	Power dissipation FULLPAK
$P_{tot} = f(T_c)$	$P_{tot} = f(T_c)$

Table 11

Max. transient thermal impedance Non FullPAK	Max. transient thermal impedance Non FullPAK
$Z_{(thJC)} = f(t_p)$; parameter: $D = t_p/T$	$Z_{(thJC)} = f(t_p)$; parameter: $D = t_p/T$

Table 12

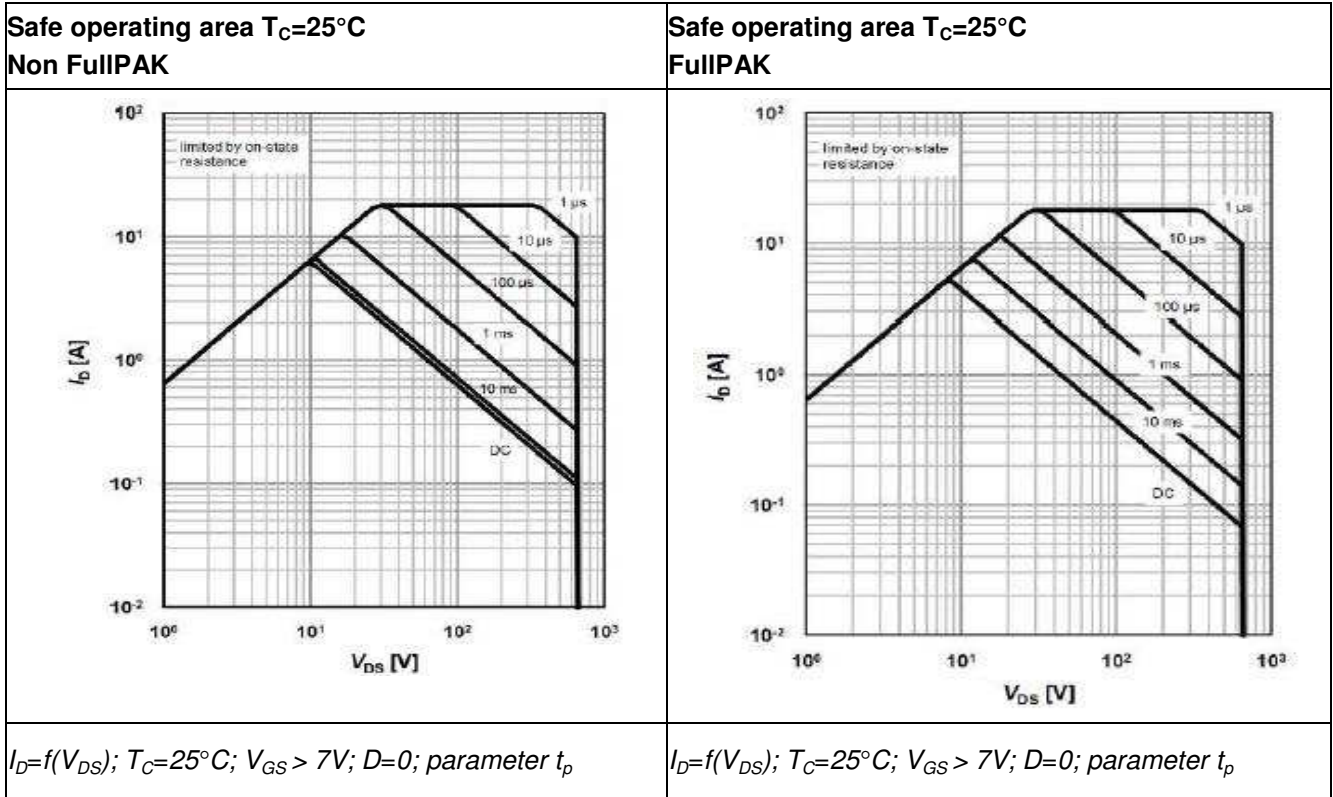

Table 13

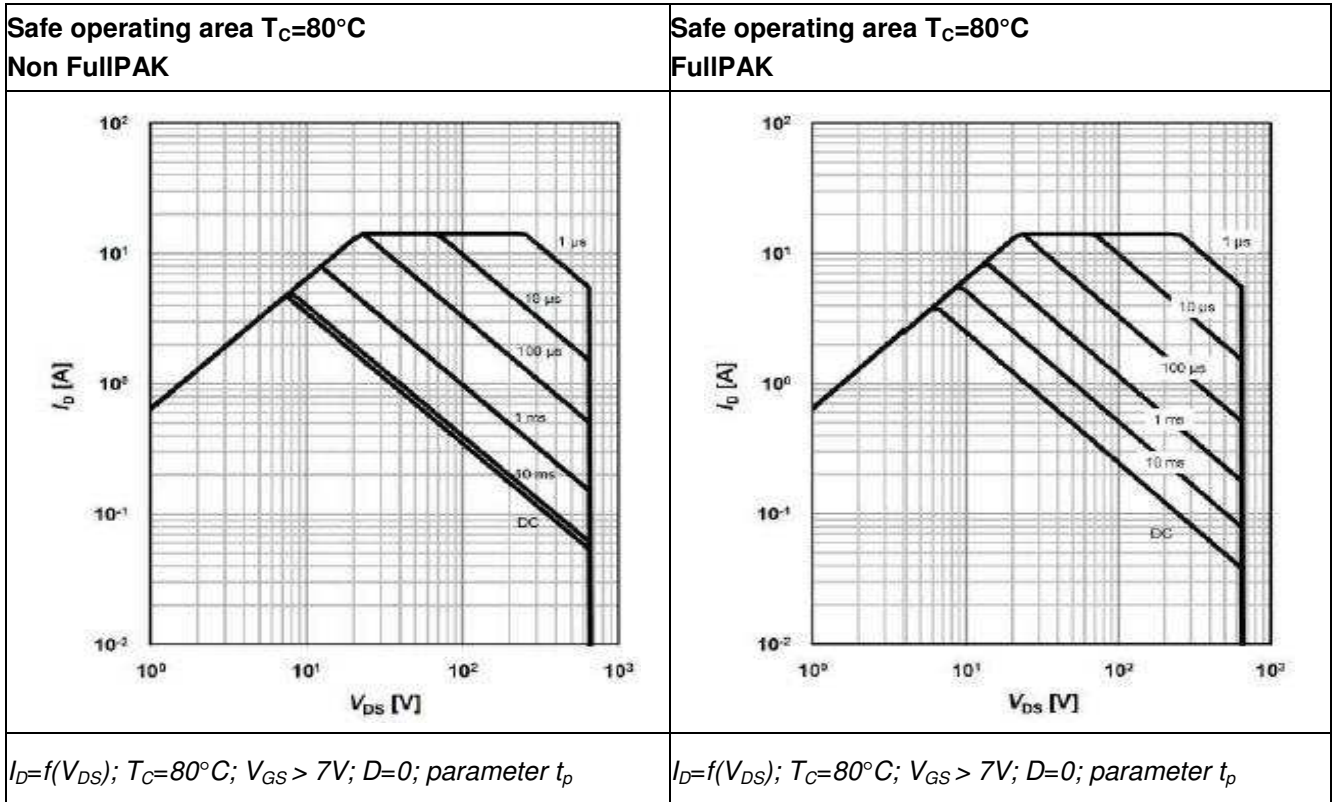

Table 14

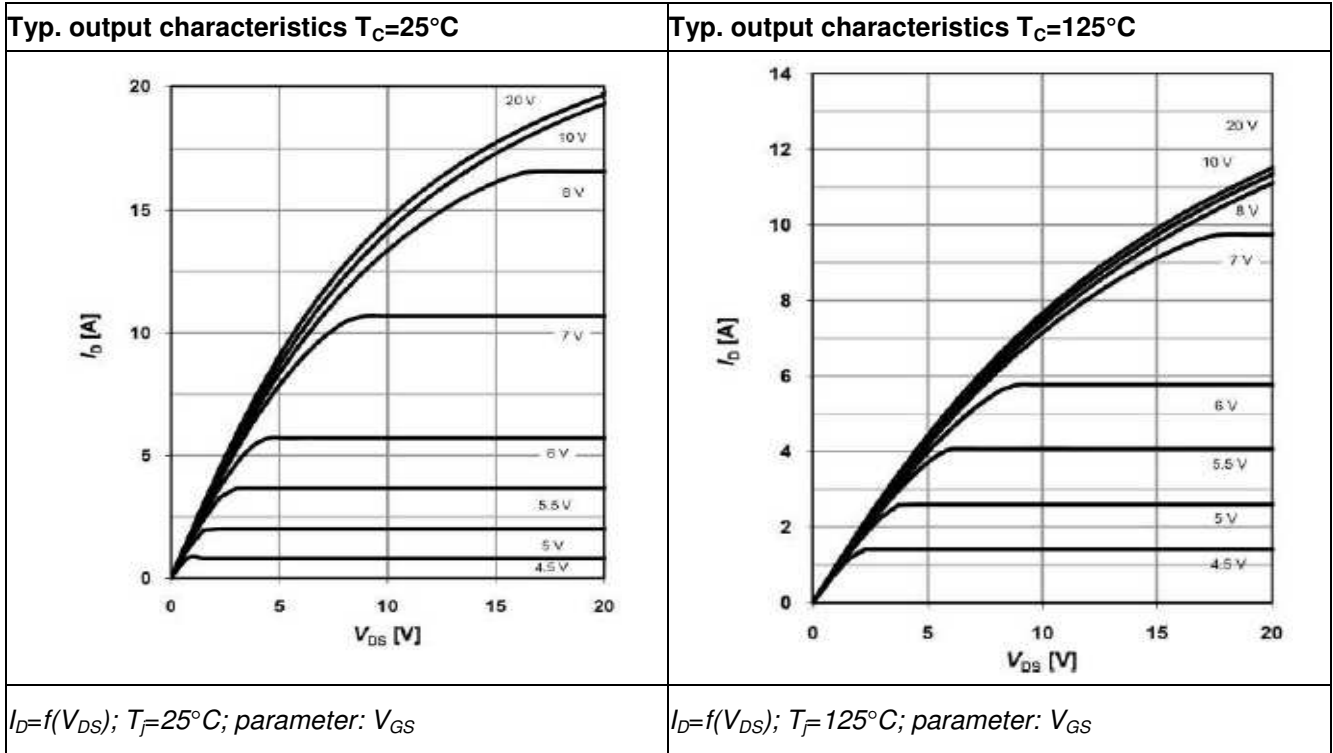

Table 15

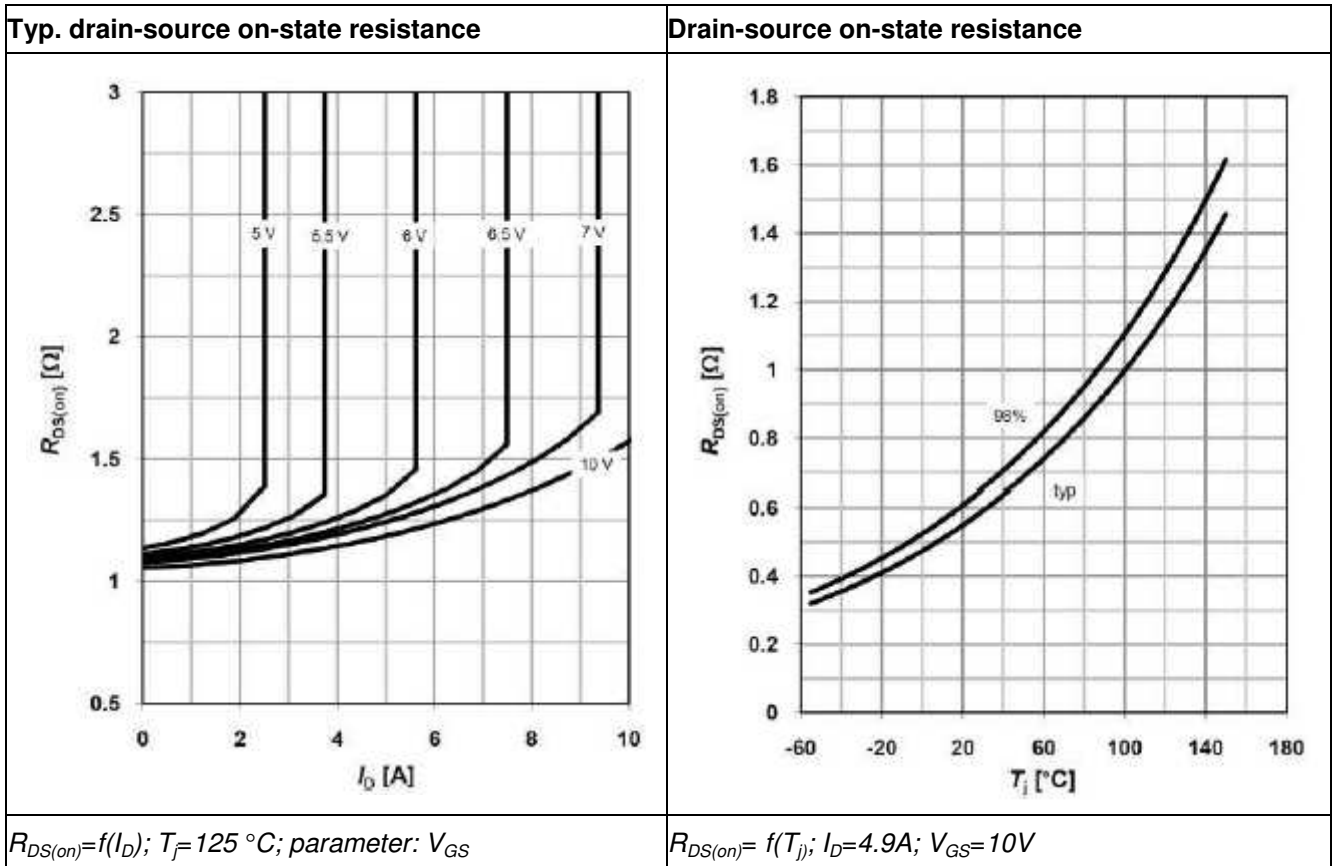

Table 16

Typ. transfer characteristics	Typ. gate charge
$I_D = f(V_{GS}); V_{DS} = 20V$	$V_{GS} = f(Q_{gate}), I_D = 4.9 A \text{ pulsed}$

Table 17

Avalanche energy	Drain-source breakdown voltage
$E_{AS} = f(T_j); I_D = 1.8 A; V_{DD} = 50 V$	$V_{BR(DSS)} = f(T_j); I_D = 1.0 mA$

Table 18

Typ. capacitances	Typ. C_{OSS} stored energy
$C=f(V_{DS}); V_{GS}=0\text{ V}; f=1\text{ MHz}$	$E_{OSS}=f(V_{DS})$

Table 19

Forward characteristics of reverse diode
$I_r=f(V_{SD}); \text{parameter: } T_j$

6 Test circuits

Table 20 Switching times test circuit and waveform for inductive load

Switching times test circuit for inductive load	Switching time waveform

Table 11

Unclamped inductive load test circuit	Unclamped inductive waveform

Table 22

Test circuit for diode characteristics	Diode recovery waveform

7 Package outlines

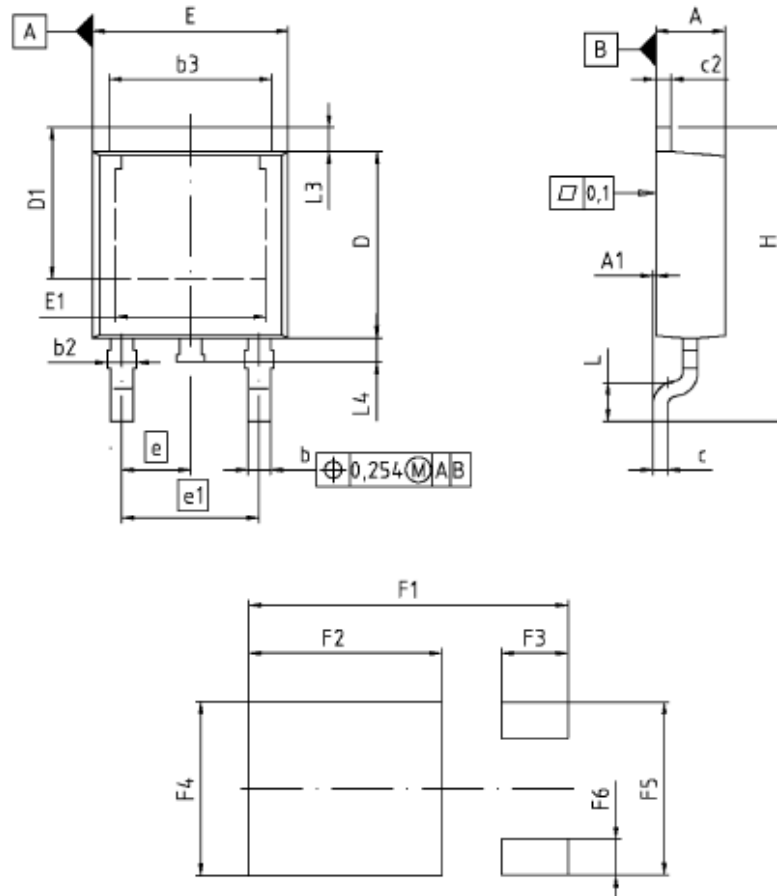

DIM	MILLIMETERS		INCHES	
	MIN	MAX	MIN	MAX
A	2.16	2.41	0.085	0.095
A1	0.00	0.15	0.000	0.008
b	0.84	0.89	0.025	0.035
b2	0.65	1.15	0.026	0.045
b3	5.00	5.50	0.197	0.217
c	0.46	0.80	0.018	0.024
c2	0.46	0.98	0.018	0.039
D	5.97	6.22	0.235	0.245
D1	5.02	5.84	0.198	0.230
E	6.40	6.73	0.252	0.265
E1	4.70	5.21	0.185	0.205
e	2.29		0.090	
e1	4.57		0.180	
N	3		3	
H	9.40	10.48	0.370	0.413
L	1.18	1.70	0.046	0.067
L3	0.90	1.25	0.035	0.049
L4	0.51	1.00	0.020	0.039
F1	10.50	10.70	0.413	0.421
F2	6.30	6.50	0.248	0.256
F3	2.10	2.30	0.083	0.091
F4	5.70	5.90	0.224	0.232
F5	5.66	5.66	0.223	0.231
F6	1.10	1.30	0.043	0.051

DOCUMENT NO. Z8B0003328
SCALE 0 2.0 4mm
EUROPEAN PROJECTION
ISSUE DATE 19-10-2007
REVISION 03

Figure 1 Outlines TO-252,, dimensions in mm/inches

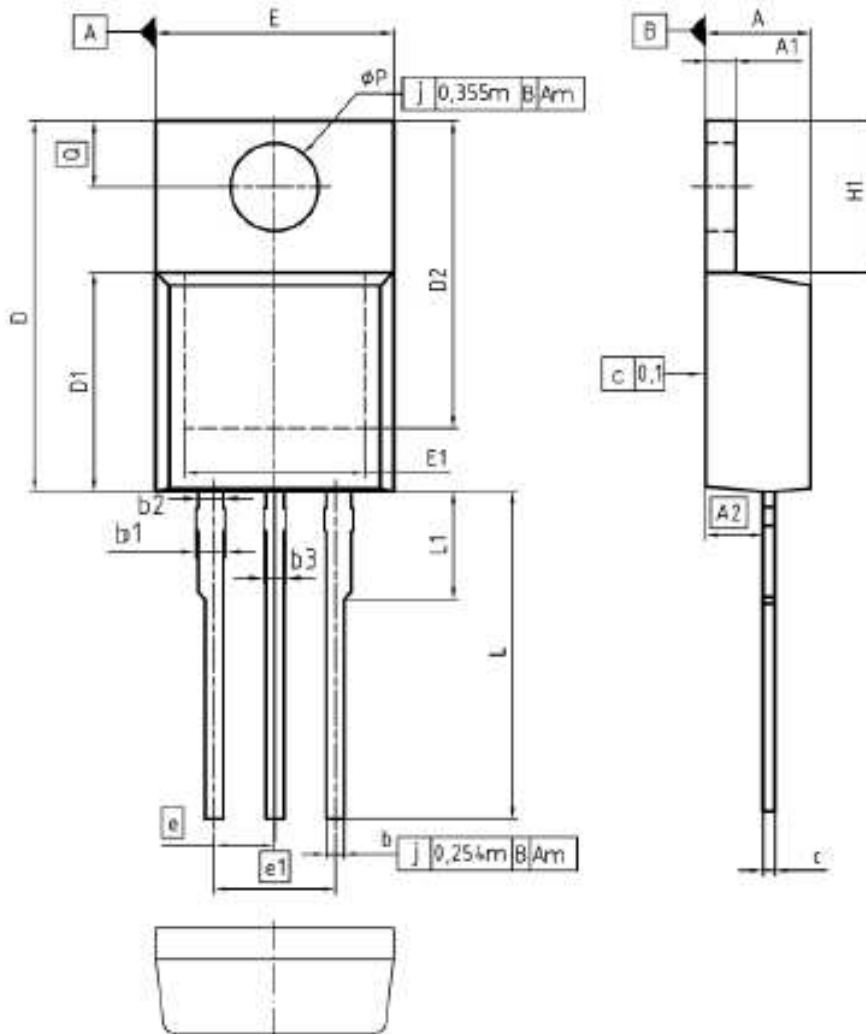

DIM	MILLIMETERS		INCHES	
	MIN	MAX	MIN	MAX
A	4.30	4.57	0.169	0.180
A1	1.17	1.40	0.046	0.055
A2	2.15	2.72	0.085	0.107
b	0.65	0.86	0.026	0.034
b1	0.95	1.40	0.037	0.055
b2	0.95	1.15	0.037	0.045
b3	0.65	1.15	0.026	0.045
c	0.33	0.60	0.013	0.024
D	14.81	15.95	0.583	0.628
D1	8.51	9.45	0.335	0.372
D2	12.19	13.10	0.480	0.516
E	9.70	10.36	0.382	0.408
E1	6.50	8.00	0.256	0.313
e	2.54		0.100	
e1	5.08		0.200	
N	3		3	
H1	6.90	6.90	0.272	0.272
L	13.00	14.00	0.512	0.551
L1	-	4.00	-	0.159
phi P	3.60	3.60	0.142	0.153
Q	2.60	3.00	0.102	0.118

DOCUMENT NO.
Z8B000C3318

SCALE

EUROPEAN PROJECTION

ISSUE DATE
23-06-2007

REVISION
05

Figure 2 Outlines TO220, dimensions in mm/inches

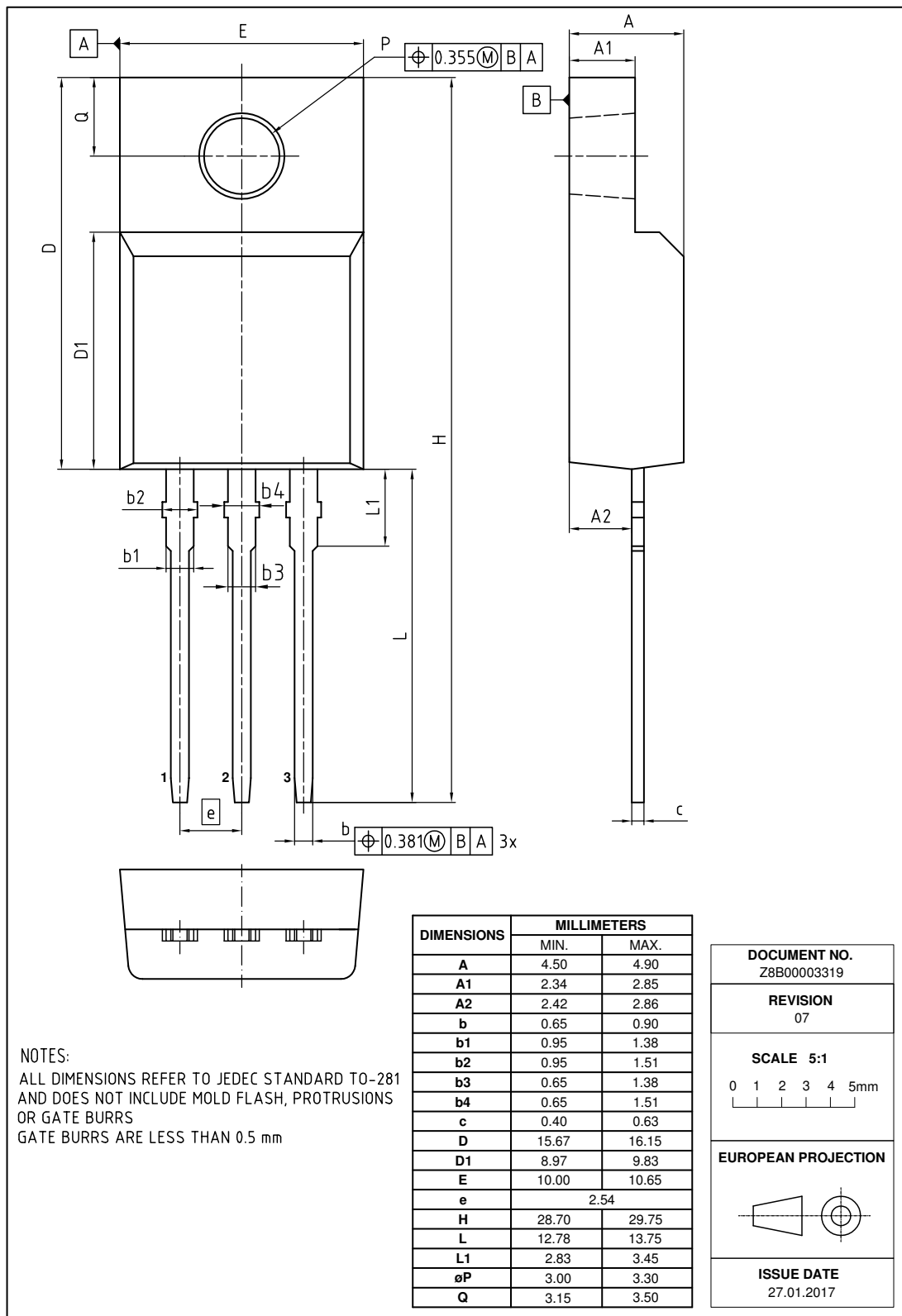

Figure 3 Outlines TO220 FullPAK, dimensions in mm

Revision History

IPx65R600E6

Revision: 2018-03-04, Rev. 2.3

Previous Revision

Revision	Date	Subjects (major changes since last revision)
2.2	2016-08-04	Revised TO220 Full PAK package drawing on page 16
2.3	2018-03-04	Outline PG-TO-220 FullPAK update

Trademarks of Infineon Technologies AG

AURIX™, C166™, CanPAK™, CIPOS™, CoolGaN™, CoolMOS™, CoolSET™, CoolSiC™, CORECONTROL™, CROSSAVE™, DAVE™, DI-POL™, DrBlade™, EasyPIM™, EconoBRIDGE™, EconoDUAL™, EconoPACK™, EconoPIM™, EiceDRIVER™, eupec™, FCOS™, HITFET™, HybridPACK™, Infineon™, ISOFACE™, IsoPACK™, i-Wafer™, MIPAQ™, ModSTACK™, my-d™, NovalithIC™, OmniTune™, OPTIGA™, OptiMOS™, ORIGA™, POWERCODE™, PRIMARION™, PrimePACK™, PrimeSTACK™, PROFET™, PRO-SIL™, RASIC™, REAL3™, ReverSave™, SatRIC™, SIEGET™, SiPMOS™, SmartLEWIS™, SOLID FLASH™, SPOC™, TEMPFET™, thinQ!™, TRENCHSTOP™, TriCore™.

Trademarks updated August 2015

Other Trademarks

All referenced product or service names and trademarks are the property of their respective owners.

We Listen to Your Comments

Any information within this document that you feel is wrong, unclear or missing at all? Your feedback will help us to continuously improve the quality of this document. Please send your proposal (including a reference to this document) to:

erratum@infineon.com

Published by
Infineon Technologies AG
81726 München, Germany
© 2018 Infineon Technologies AG
All Rights Reserved.

Legal Disclaimer

The information given in this document shall in no event be regarded as a guarantee of conditions or characteristics ("Beschaffheitsgarantie").

With respect to any examples, hints or any typical values stated herein and/or any information regarding the application of the product, Infineon Technologies hereby disclaims any and all warranties and liabilities of any kind, including without limitation warranties of non-infringement of intellectual property rights of any third party.

In addition, any information given in this document is subject to customer's compliance with its obligations stated in this document and any applicable legal requirements, norms and standards concerning customer's products and any use of the product of Infineon Technologies in customer's applications.

The data contained in this document is exclusively intended for technically trained staff. It is the responsibility of customer's technical departments to evaluate the suitability of the product for the intended application and the completeness of the product information given in this document with respect to such application.

Information

For further information on technology, delivery terms and conditions and prices please contact your nearest Infineon Technologies Office (www.infineon.com).

Warnings

Due to technical requirements, components may contain dangerous substances. For information on the types in question, please contact the nearest Infineon Technologies Office.





The Infineon Technologies component described in this Data Sheet may be used in life-support devices or systems and/or automotive, aviation and aerospace applications or systems only with the express written approval of Infineon Technologies, if a failure of such components can reasonably be expected to cause the failure of that life-support, automotive, aviation and aerospace device or system or to affect the safety or effectiveness of that device or system. Life support devices or systems are intended to be implanted in the human body or to support and/or maintain and sustain and/or protect human life. If they fail, it is reasonable to assume that the health of the user or other persons may be endangered.

Looking for pricing, stock, or lifecycle information?

Click below to explore more details on WIN SOURCE:

-  [View IPD65R600E6BTMA1 on WIN SOURCE](#)
-  [Infineon Technologies Information](#)

Optimize Your Supply Chain with WIN SOURCE Solutions

-  Global Sourcing Solution
-  Obsolete Management
-  Cost Control Management
-  Shortage Management
-  Alternative Solution
-  Excess Inventory Management