



**THE DATASHEET OF  
IPI60R099CPAAKSA1**



**CoolMOS™ Power Transistor**

**Product Summary**

$V_{DS}$	600	V
$R_{DS(on),max}$	0.105	$\Omega$
$Q_{g,typ}$	60	nC

**Features**

- Worldwide best  $R_{ds,on}$  in TO262
- Ultra low gate charge
- Extreme  $dv/dt$  rated
- High peak current capability
- Automotive AEC Q101 qualified
- Green package (RoHS compliant)

**CoolMOS CPA is specially designed for:**

- DC/DC converters for Automotive Applications

PG-TO262-3-1

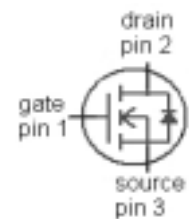

Type	Package	Marking
IPI60R099CPA	PG-TO262-3-1	6R099A

**Maximum ratings, at  $T_j=25\text{ }^\circ\text{C}$ , unless otherwise specified**

Parameter	Symbol	Conditions	Value	Unit
Continuous drain current	$I_D$	$T_C=25\text{ }^\circ\text{C}$	31	A
		$T_C=100\text{ }^\circ\text{C}$	19	
Pulsed drain current <sup>1)</sup>	$I_{D,pulse}$	$T_C=25\text{ }^\circ\text{C}$	93	
Avalanche energy, single pulse	$E_{AS}$	$I_D=11\text{ A}$ , $V_{DD}=50\text{ V}$	800	mJ
Avalanche energy, repetitive $t_{AR}$ <sup>1),2)</sup>	$E_{AR}$	$I_D=11\text{ A}$ , $V_{DD}=50\text{ V}$	1.2	
Avalanche current, repetitive $t_{AR}$ <sup>1),2)</sup>	$I_{AR}$		11	A
MOSFET $dv/dt$ ruggedness	$dv/dt$	$V_{DS}=0\dots480\text{ V}$	50	V/ns
Gate source voltage	$V_{GS}$	static	$\pm 20$	V
Power dissipation	$P_{tot}$	$T_C=25\text{ }^\circ\text{C}$	255	W
Operating temperature	$T_j$		-40 ... 150	$^\circ\text{C}$
Storage temperature	$T_{stg}$		-40 ... 150	

**Maximum ratings, at  $T_j=25\text{ °C}$ , unless otherwise specified**

Parameter	Symbol	Conditions	Value	Unit
Continuous diode forward current	$I_S$	$T_C=25\text{ °C}$	18	A
Diode pulse current <sup>1)</sup>	$I_{S,pulse}$		93	
Reverse diode $dv/dt$ <sup>3)</sup>	$dv/dt$		15	V/ns

Parameter	Symbol	Conditions	Values			Unit
			min.	typ.	max.	

**Thermal characteristics**

Thermal resistance, junction - case	$R_{thJC}$		-	-	0.5	K/W
Thermal resistance, junction - ambient	$R_{thJA}$	leaded	-	-	62	
Soldering temperature, wavesoldering only allowed at leads	$T_{sold}$	1.6 mm (0.063 in.) from case for 10 s	-	-	260	°C
Soldering temperature, reflow soldering	$T_{sold}$	MSL1, reflow acc. to IPC-JEDEC J-STD-020C	-	-	245	°C

**Electrical characteristics, at  $T_j=25\text{ °C}$ , unless otherwise specified**
**Static characteristics**

Drain-source breakdown voltage	$V_{(BR)DSS}$	$V_{GS}=0\text{ V}$ , $I_D=250\text{ }\mu\text{A}$	600	-	-	V
Gate threshold voltage	$V_{GS(th)}$	$V_{DS}=V_{GS}$ , $I_D=1.2\text{ mA}$	2.5	3	3.5	
Zero gate voltage drain current	$I_{DSS}$	$V_{DS}=600\text{ V}$ , $V_{GS}=0\text{ V}$ , $T_j=25\text{ °C}$	-	-	5	$\mu\text{A}$
Gate-source leakage current	$I_{GSS}$	$V_{GS}=20\text{ V}$ , $V_{DS}=0\text{ V}$	-	-	100	nA
Drain-source on-state resistance	$R_{DS(on)}$	$V_{GS}=10\text{ V}$ , $I_D=18\text{ A}$ , $T_j=25\text{ °C}$	-	0.09	0.105	$\Omega$
		$V_{GS}=10\text{ V}$ , $I_D=18\text{ A}$ , $T_j=150\text{ °C}$	-	0.24	-	
Gate resistance	$R_G$	$f=1\text{ MHz}$ , open drain	-	1.3	-	$\Omega$

Parameter	Symbol	Conditions	Values			Unit
			min.	typ.	max.	

**Dynamic characteristics**

Input capacitance	$C_{iss}$	$V_{GS}=0\text{ V}, V_{DS}=100\text{ V},$ $f=1\text{ MHz}$	-	2800	-	pF
Output capacitance	$C_{oss}$		-	130	-	
Effective output capacitance, energy related <sup>4)</sup>	$C_{o(er)}$	$V_{GS}=0\text{ V}, V_{DS}=0\text{ V}$ to 480 V	-	130	-	
Effective output capacitance, time related <sup>5)</sup>	$C_{o(tr)}$		-	340	-	
Turn-on delay time	$t_{d(on)}$	$V_{DD}=400\text{ V},$ $V_{GS}=10\text{ V}, I_D=18\text{ A},$ $R_G=3.3\ \Omega$	-	10	-	ns
Rise time	$t_r$		-	5	-	
Turn-off delay time	$t_{d(off)}$		-	60	-	
Fall time	$t_f$		-	5	-	

**Gate Charge Characteristics**

Gate to source charge	$Q_{gs}$	$V_{DD}=400\text{ V}, I_D=18\text{ A},$ $V_{GS}=0\text{ to }10\text{ V}$	-	14	-	nC
Gate to drain charge	$Q_{gd}$		-	20	-	
Gate charge total	$Q_g$		-	60	80	
Gate plateau voltage	$V_{plateau}$		-	5.0	-	V

**Reverse Diode**

Diode forward voltage	$V_{SD}$	$V_{GS}=0\text{ V}, I_F=18\text{ A},$ $T_J=25\text{ }^\circ\text{C}$	-	0.9	1.2	V
Reverse recovery time	$t_{rr}$	$V_R=400\text{ V}, I_F=I_S,$ $di_F/dt=100\text{ A}/\mu\text{s}$	-	450	-	ns
Reverse recovery charge	$Q_{rr}$		-	12	-	$\mu\text{C}$
Peak reverse recovery current	$I_{rrm}$		-	70	-	A

<sup>1)</sup> Pulse width  $t_p$  limited by  $T_{j,max}$

<sup>2)</sup> Repetitive avalanche causes additional power losses that can be calculated as  $P_{AV}=E_{AR} \cdot f$ .

<sup>3)</sup>  $I_{SD} \leq I_D$ ,  $di/dt \leq 100\text{ A}/\mu\text{s}$ ,  $V_{DClink}=400\text{ V}$ ,  $V_{peak} < V_{(BR)DSS}$ ,  $T_J < T_{j,max}$ , identical low side and high side switch

<sup>4)</sup>  $C_{o(er)}$  is a fixed capacitance that gives the same stored energy as  $C_{oss}$  while  $V_{DS}$  is rising from 0 to 80%  $V_{DSS}$ .

<sup>5)</sup>  $C_{o(tr)}$  is a fixed capacitance that gives the same charging time as  $C_{oss}$  while  $V_{DS}$  is rising from 0 to 80%  $V_{DSS}$ .

**1 Power dissipation**

$P_{tot}=f(T_C)$

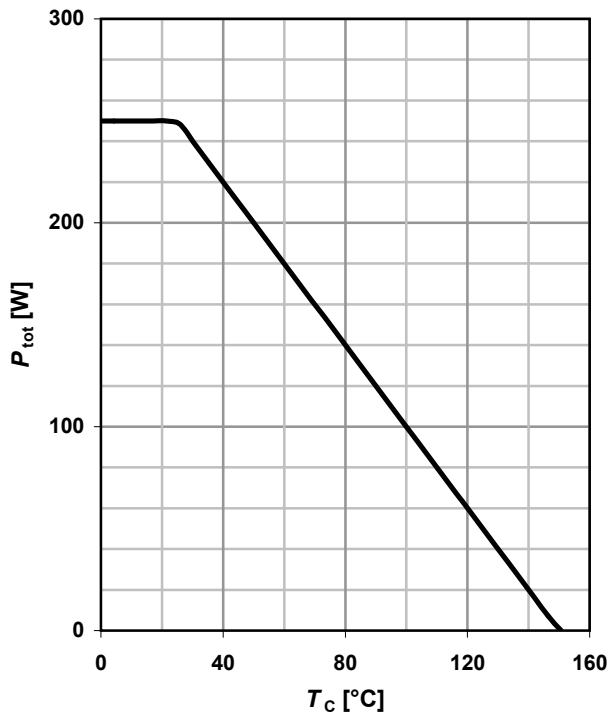

**2 Safe operating area**

$I_D=f(V_{DS}); T_C=25\text{ °C}; D=0$

parameter:  $t_p$

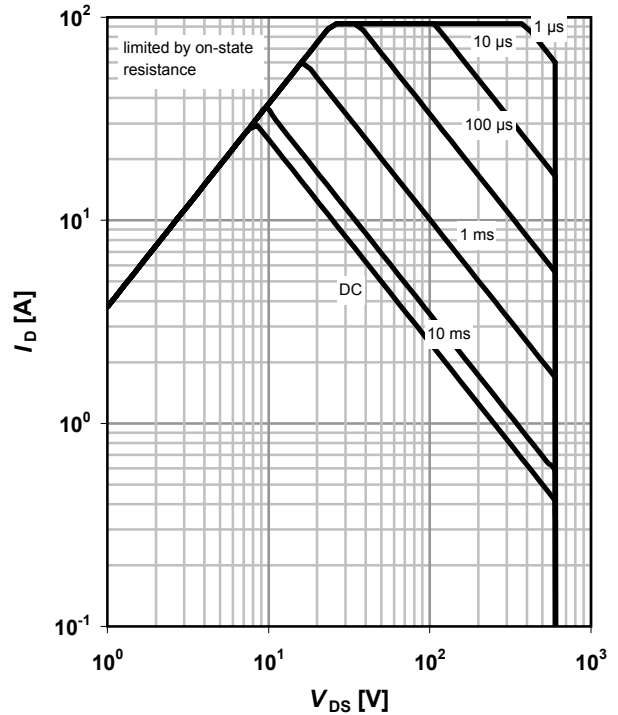

**3 Max. transient thermal impedance**

$Z_{thJC}=f(t_p)$

parameter:  $D=t_p/T$

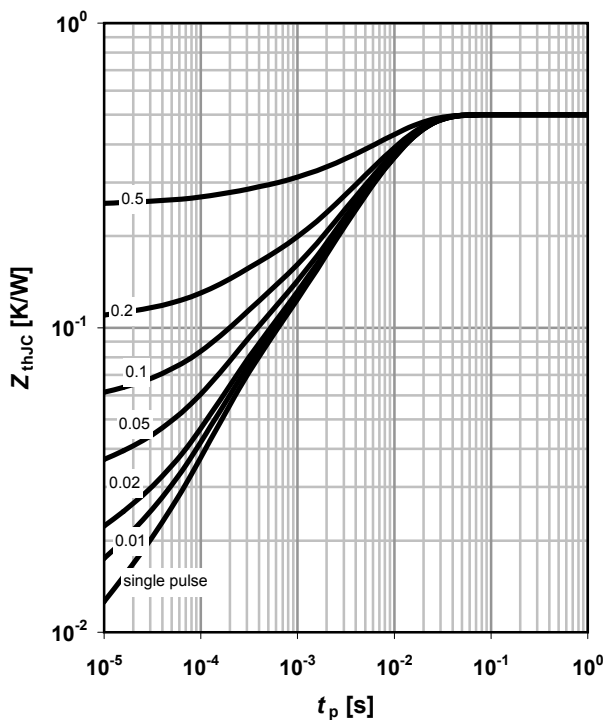

**4 Typ. output characteristics**

$I_D=f(V_{DS}); T_j=25\text{ °C}$

parameter:  $V_{GS}$

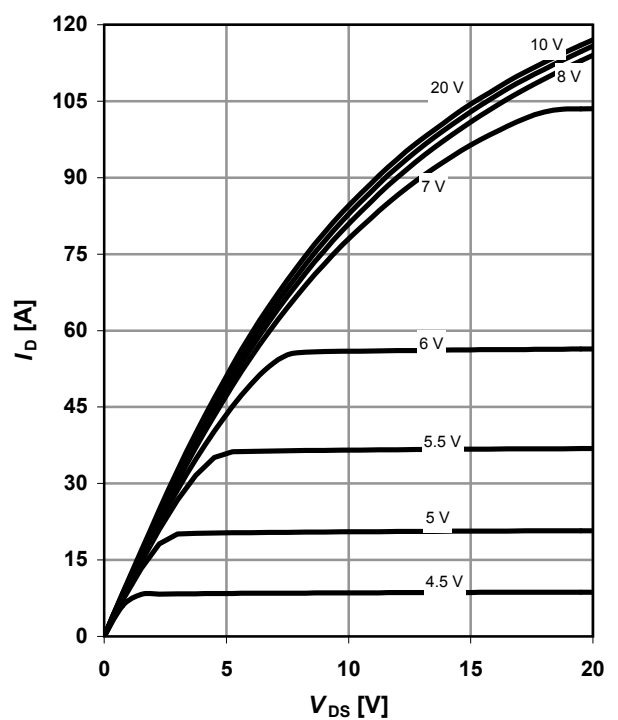

**5 Typ. output characteristics**

$I_D = f(V_{DS}); T_j = 150\text{ }^\circ\text{C}$

parameter:  $V_{GS}$

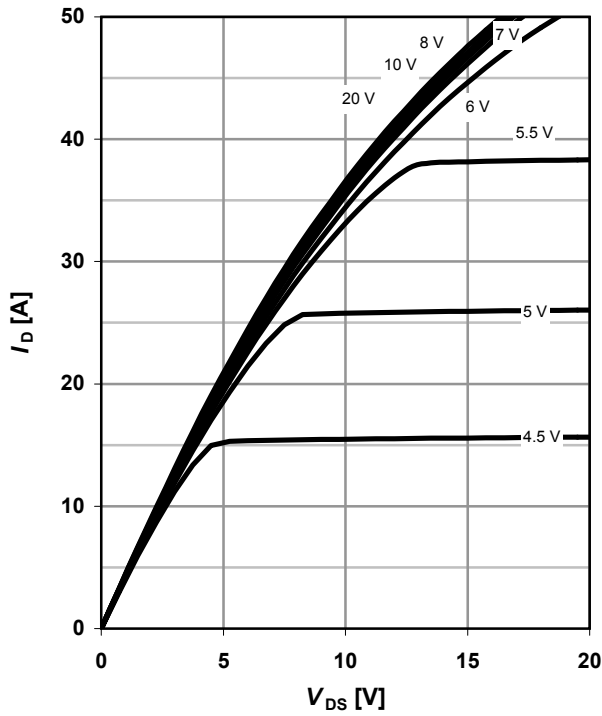

**6 Typ. drain-source on-state resistance**

$R_{DS(on)} = f(I_D); T_j = 150\text{ }^\circ\text{C}$

parameter:  $V_{GS}$

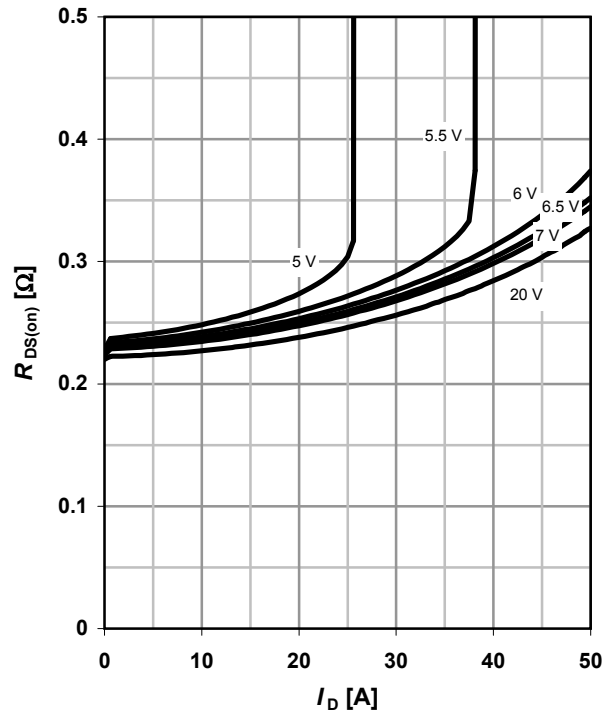

**7 Drain-source on-state resistance**

$R_{DS(on)} = f(T_j); I_D = 18\text{ A}; V_{GS} = 10\text{ V}$

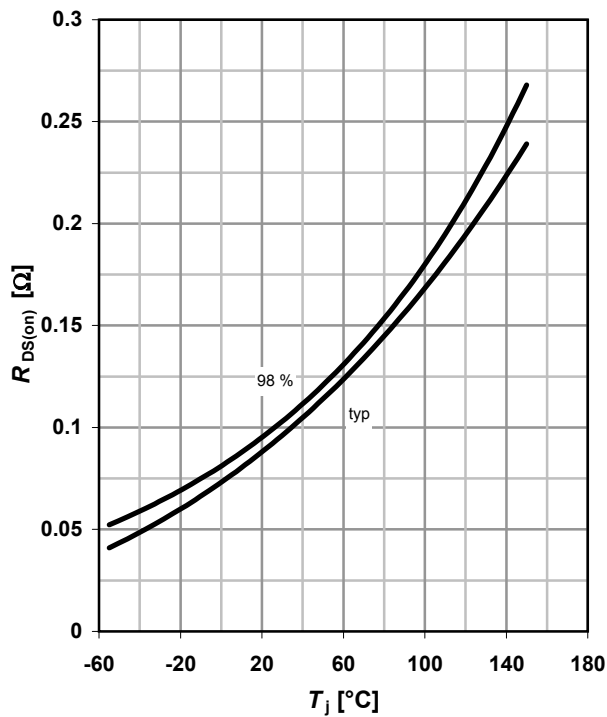

**8 Typ. transfer characteristics**

$I_D = f(V_{GS}); |V_{DS}| > 2|I_D|R_{DS(on)max}$

parameter:  $T_j$

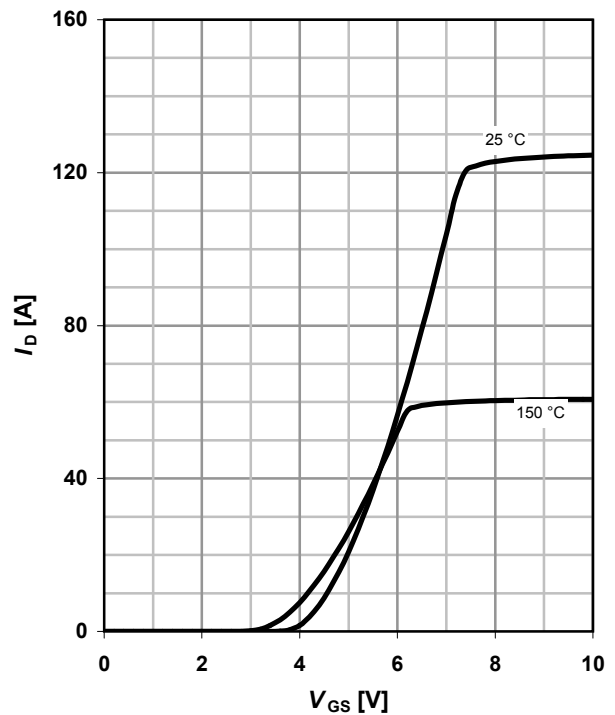

**9 Typ. gate charge**

$V_{GS}=f(Q_{gate}); I_D=18\text{ A pulsed}$

parameter:  $V_{DD}$

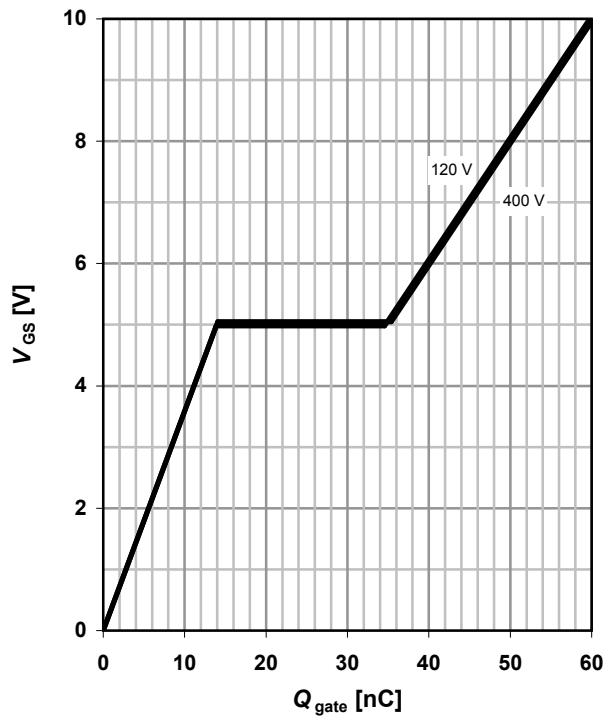

**10 Forward characteristics of reverse diode**

$I_F=f(V_{SD})$

parameter:  $T_j$

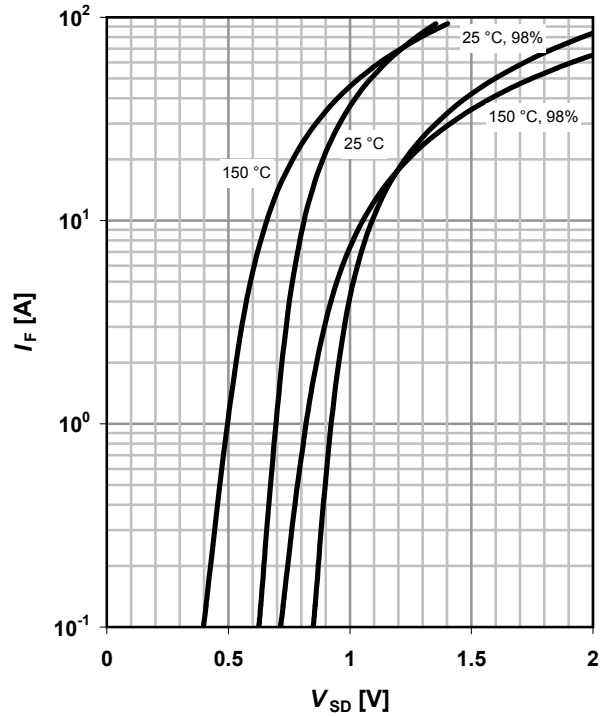

**11 Avalanche energy**

$E_{AS}=f(T_j); I_D=11\text{ A}; V_{DD}=50\text{ V}$

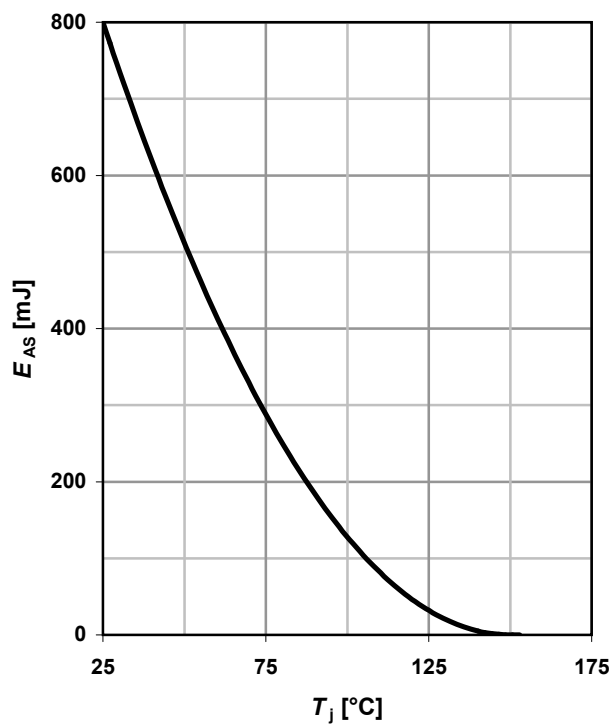

**12 Drain-source breakdown voltage**

$V_{BR(DSS)}=f(T_j); I_D=0.25\text{ mA}$

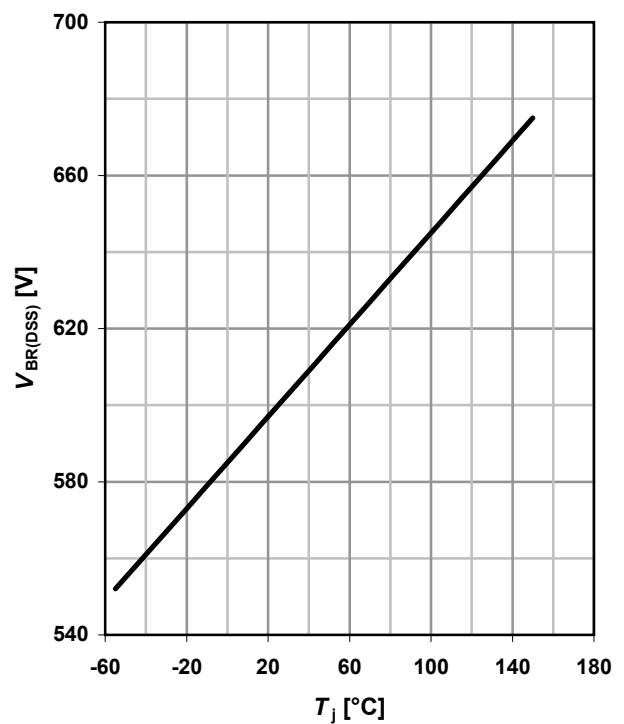

**13 Typ. capacitances**

$C=f(V_{DS}); V_{GS}=0\text{ V}; f=1\text{ MHz}$

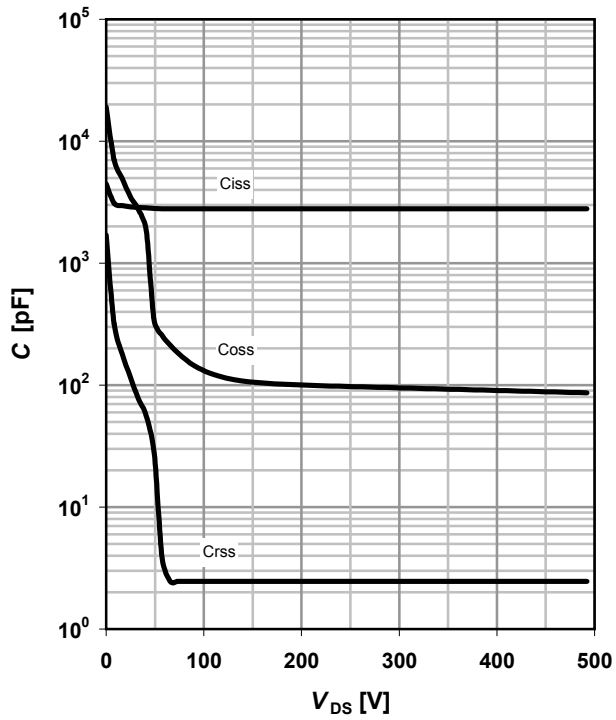

**14 Typ. Coss stored energy**

$E_{oss}=f(V_{DS})$

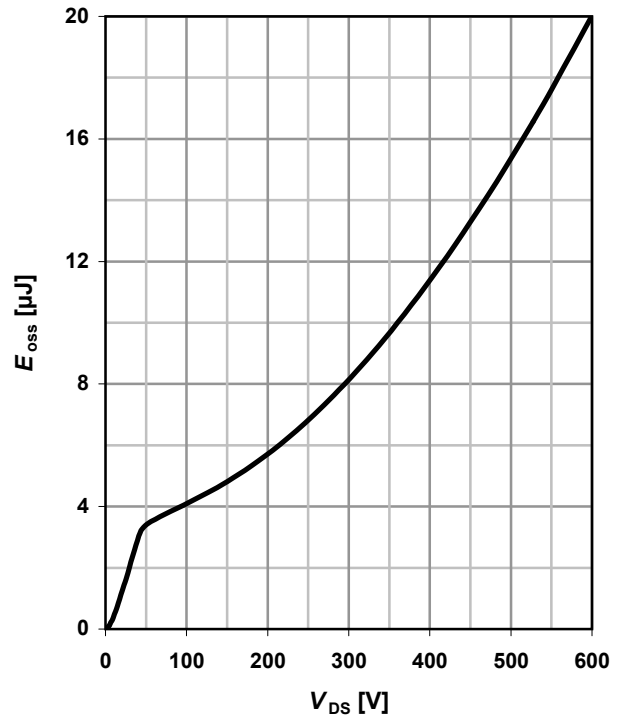

Definition of diode switching characteristics

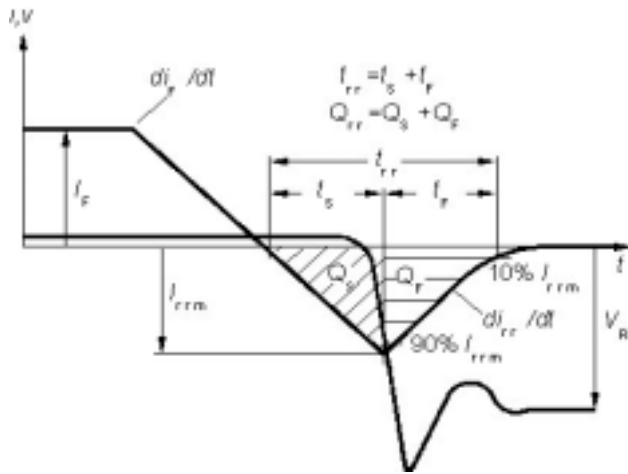

PG-TO262-3-1: Outlines

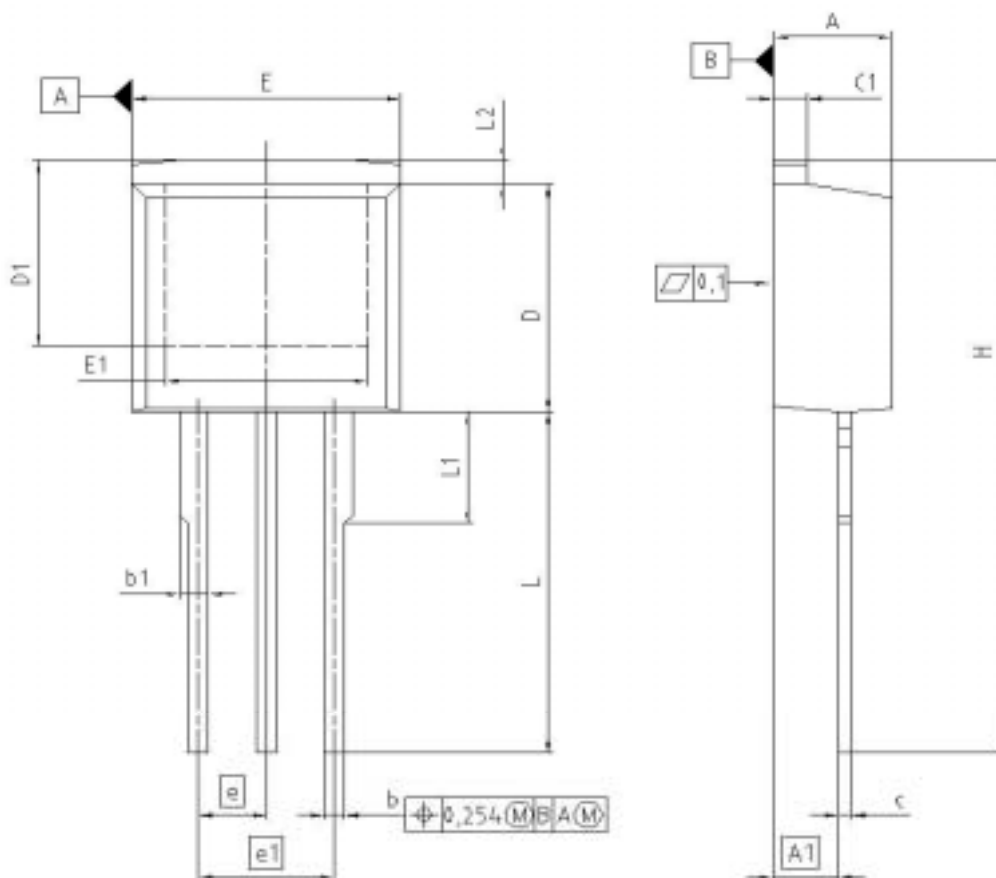

to

DIM	MILLIMETERS		INCHES	
	MIN	MAX	MIN	MAX
A	4.300	4.500	0.169	0.177
A1	2.150	2.650	0.085	0.104
b	0.850	0.850	0.026	0.033
b1	0.635	1.400	0.025	0.055
e	0.400	0.600	0.016	0.024
c1	1.170	1.370	0.046	0.054
D	8.050	9.450	0.356	0.372
D1	6.900	7.650	0.272	0.301
E	9.800	10.200	0.386	0.402
E1	7.250	8.600	0.285	0.339
e	2.540		0.100	
e1	5.080		0.200	
N	3		3	
L	13.000	14.000	0.512	0.551
L1	4.350	4.750	0.171	0.187
L2	0.700	1.300	0.028	0.051

REFERENCE  
JEDEC TO262

SCALE

EUROPEAN PROJECTION

ISSUE DATE  
01-06-2005

FILE  
TO262\_1

Dimensions in mm/inches

**Published by**  
**Infineon Technologies AG**  
**81726 München, Germany**  
**© Infineon Technologies AG 2009.**  
**All Rights Reserved.**

#### **Legal Disclaimer**

The information given in this document shall in no event be regarded as a guarantee of conditions or characteristics ("Beschaffenheitsgarantie"). With respect to any examples or hints given herein, any typical values stated herein and/or any information regarding the application of the device, Infineon Technologies hereby disclaims any and all warranties and liabilities of any kind, including without limitation warranties of non-infringement of intellectual property rights of any third party.

#### **Information**

For further information on technology, delivery terms and conditions and prices please contact your nearest Infineon Technologies Office ([www.infineon.com](http://www.infineon.com)).

#### **Warnings**

Due to technical requirements components may contain dangerous substances. For information on the types in question please contact your nearest Infineon Technologies Office.  
Infineon Technologies Components may only be used in life-support devices or systems with the express written approval of Infineon Technologies, if a failure of such components can reasonably be expected to cause the failure of that life-support device or system, or to affect the safety or effectiveness of that device or system. Life support devices or systems are intended to be implanted in the human body, or to support and/or maintain and sustain and/or protect human life. If they fail, it is reasonable to assume that the health of the user or other persons may be endangered.

# NOTIFICATION



N° 040/10

## Information on N-Channel MOSFET products designed for automotive applications

<b>Products affected:</b>	<b>SalesName</b>	<b>Package</b>
	IPB60R099CPA	PG-TO263-3-2
	IPB60R199CPA	PG-TO263-3-2
	IPB60R299CPA	PG-TO263-3-2
	IPC60R075CPA	Bare Die
	IPI60R099CPA	PG-TO262-3-1
	IPP60R099CPA	PG-TO220-3-1
	IPW60R045CPA	PG-TO247-3-41
	IPW60R075CPA	PG-TO247-3-41
	IPW60R099CPA	PG-TO247-3-41

Dear Customer,

The devices listed for this notification are sensitive to hard commutation of the conducting body diode. This operating condition can occur in half-bridge configurations used in ZVS phase shift and resonant switching PWM converters. Using the device under such conditions may result in violation of the datasheet specification limits and may lead to permanent damage of the device.

Please take care that in the context of the application described above the datasheet limits are not exceeded.

Best Regards

Michael Paulu

If you have any questions, please do not hesitate to contact your local Sales office.

## Looking for pricing, stock, or lifecycle information?

Click below to explore more details on WIN SOURCE:

- [⊖ View IPI60R099CPAAKSA1 on WIN SOURCE](#)
- [⊖ Infineon Technologies Information](#)

## Optimize Your Supply Chain with WIN SOURCE Solutions

- ✓ Global Sourcing Solution
- ✓ Obsolete Management
- ✓ Cost Control Management
- ✓ Shortage Management
- ✓ Alternative Solution
- ✓ Excess Inventory Management