



# THE DATASHEET OF IPS65R950C6



# MOSFET

Metal Oxide Semiconductor Field Effect Transistor

## CoolMOS™ C6 650V

650V CoolMOS™ C6 Power Transistor  
IPS65R950C6

## Data Sheet

Rev. 2.0  
Final

Industrial & Multimarket

## 1 Description

CoolMOS™ is a revolutionary technology for high voltage power MOSFETs, designed according to the superjunction (SJ) principle and pioneered by Infineon Technologies. CoolMOS™ C6 series combines the experience of the leading SJ MOSFET supplier with high class innovation. The resulting devices provide all benefits of a fast switching SJ MOSFET while not sacrificing ease of use. Extremely low switching and conduction losses make switching applications even more efficient, more compact, lighter and cooler.

### Features

- Extremely low losses due to very low FOM  $R_{ds(on)} \cdot Q_g$  and  $E_{oss}$
- Very high commutation ruggedness
- Easy to use/drive
- Pb-free plating, Halogen free mold compound
- Qualified for industrial grade applications according to JEDEC (J-STD20 and JESD22)

### Applications

PFC stages, hard switching PWM stages and resonant switching PWM stages for e.g. PC Silverbox, Adapter, LCD & PDP TV, Lighting, Server, Telecom and UPS.

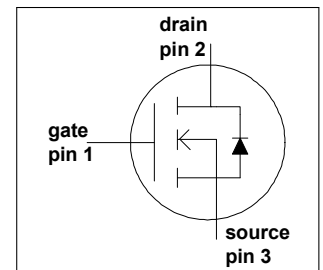

**Table 1 Key Performance Parameters**

Parameter	Value	Unit
$V_{DS} @ T_{j \max}$	700	V
$R_{DS(on), \max}$	0.95	$\Omega$
$Q_g, \text{typ}$	15.3	nC
$I_D, \text{pulse}$	12	A
$E_{oss} @ 400V$	1.5	$\mu J$
Body diode $di/dt$	500	A/ $\mu s$

Type / Ordering Code	Package	Marking	Related Links
IPS65R950C6	PG-TO 251	65C6950	see Appendix A

**Table of Contents**

Description .....	2
Table of Contents .....	3
Maximum ratings .....	4
Thermal characteristics .....	5
Electrical characteristics .....	6
Electrical characteristics diagrams .....	8
Test Circuits .....	12
Package Outlines .....	13
Appendix A .....	14
Revision History .....	15
Disclaimer .....	15

## 2 Maximum ratings

at  $T_j = 25^\circ\text{C}$ , unless otherwise specified

**Table 2 Maximum ratings**

Parameter	Symbol	Values			Unit	Note / Test Condition
		Min.	Typ.	Max.		
Continuous drain current <sup>1)</sup>	$I_D$			4.5	A	$T_C = 25^\circ\text{C}$
				2.8		$T_C = 100^\circ\text{C}$
Pulsed drain current <sup>2)</sup>	$I_{D,pulse}$			12	A	$T_C = 25^\circ\text{C}$
Avalanche energy, single pulse	$E_{AS}$			50	mJ	$I_D = 1.0\text{A}$ , $V_{DD} = 50\text{V}$ (see table 18)
Avalanche energy, repetitive	$E_{AR}$			0.15	mJ	$I_D = 1.0\text{A}$ , $V_{DD} = 50\text{V}$
Avalanche current, repetitive	$I_{AR}$			1.0	A	
MOSFET dv/dt ruggedness	dv/dt			50	V/ns	$V_{DS} = 0 \dots 480\text{V}$
Gate source voltage	$V_{GS}$	-20		20	V	static
		-30		30		AC ( $f > 1\text{ Hz}$ )
Operating and storage temperature	$T_j, T_{stg}$	-55		150	$^\circ\text{C}$	
Continuous diode forward current	$I_S$			3.9	A	$T_C = 25^\circ\text{C}$
Diode pulse current	$I_{S,pulse}$			12	A	$T_C = 25^\circ\text{C}$
Reverse diode dv/dt <sup>3)</sup>	dv/dt			15	V/ns	$V_{DS} = 0 \dots 400\text{V}$ , $I_{SD} \leq I_D$ , $T_j = 25^\circ\text{C}$ (see table 16)
Maximum diode commutation speed	$di_t/dt$			500	A/ $\mu\text{s}$	
Power dissipation	$P_{tot}$			37	W	$T_C = 25^\circ$

<sup>1)</sup> Limited by  $T_{j,max}$ . Maximum duty cycle  $D=0.75$

<sup>2)</sup> Pulse width  $t_p$  limited by  $T_{j,max}$

<sup>3)</sup> Identical low side and high side switch with identical  $R_G$

### 3 Thermal characteristics

**Table 3 Thermal characteristics IPAK SL**

Parameter	Symbol	Values			Unit	Note / Test Condition
		Min.	Typ.	Max.		
Thermal resistance, junction - case	$R_{thJC}$			3.4	°C/W	
Thermal resistance, junction - ambient	$R_{thJA}$			62	°C/W	leaded
			35			
Soldering temperature, wave- & reflowsoldering allowed	$T_{sold}$			260	°C	1.6 mm (0.063 in.) from case for 10s

## 4 Electrical characteristics

at  $T_j = 25^\circ\text{C}$ , unless otherwise specified

**Table 4 Static characteristics**

Parameter	Symbol	Values			Unit	Note / Test Condition
		Min.	Typ.	Max.		
Drain-source breakdown voltage	$V_{(BR)DSS}$	650			V	$V_{GS} = 0\text{V}$ , $I_D = 1\text{mA}$
Gate threshold voltage	$V_{GS(th)}$	2.5	3	3.5	V	$V_{DS} = V_{GS}$ , $I_D = 0.2\text{mA}$
Zero gate voltage drain current	$I_{DSS}$			1	$\mu\text{A}$	$V_{DS} = 650\text{V}$ , $V_{GS} = 0\text{V}$ , $T_j = 25^\circ\text{C}$
			10			$V_{DS} = 650\text{V}$ , $V_{GS} = 0\text{V}$ , $T_j = 150^\circ\text{C}$
Gate-source leakage current	$I_{GSS}$			100	nA	$V_{GS} = 20\text{V}$ , $V_{DS} = 0\text{V}$
Drain-source on-state resistance	$R_{DS(on)}$		0.855	0.95	$\Omega$	$V_{GS} = 10\text{V}$ , $I_D = 1.5\text{A}$ , $T_j = 25^\circ\text{C}$
			2.223			$V_{GS} = 10\text{V}$ , $I_D = 1.5\text{A}$ , $T_j = 150^\circ\text{C}$
Gate resistance	$R_G$		5.5		$\Omega$	$f = 1\text{MHz}$ , open drain

**Table 5 Dynamic characteristics**

Parameter	Symbol	Values			Unit	Note / Test Condition
		Min.	Typ.	Max.		
Input capacitance	$C_{iss}$		328		pF	$V_{GS} = 0\text{V}$ , $V_{DS} = 100\text{V}$ , $f = 1\text{MHz}$
Output capacitance	$C_{oss}$		23			
Effective output capacitance, energy related <sup>1)</sup>	$C_{o(er)}$		14		pF	$V_{GS} = 0\text{V}$ , $V_{DS} = 0 \dots 480\text{V}$
Effective output capacitance, time related <sup>2)</sup>	$C_{o(tr)}$		58.5		pF	$I_D = \text{constant}$ , $V_{GS} = 0\text{V}$ , $V_{DS} = 0 \dots 480\text{V}$
Turn-on delay time	$t_{d(on)}$		6.6		ns	$V_{DD} = 400\text{V}$ , $V_{GS} = 13\text{V}$ , $I_D = 2.2\text{A}$ , $R_G = 10.2\Omega$ (see table 17)
Rise time	$t_r$		5.2			
Turn-off delay time	$t_{d(off)}$		41			
Fall time	$t_f$		13.6			

**Table 6 Gate charge characteristics**

Parameter	Symbol	Values			Unit	Note / Test Condition
		Min.	Typ.	Max.		
Gate to source charge	$Q_{gs}$		1.8		nC	$V_{DD} = 480\text{V}$ , $I_D = 2.2\text{A}$ , $V_{GS} = 0 \text{ to } 10\text{V}$
Gate to drain charge	$Q_{gd}$		8			
Gate charge total	$Q_g$		15.3			
Gate plateau voltage	$V_{plateau}$		5.1			

<sup>1)</sup>  $C_{o(er)}$  is a fixed capacitance that gives the same stored energy as  $C_{oss}$  while  $V_{DS}$  is rising from 0 to 80%  $V_{(BR)DSS}$

<sup>2)</sup>  $C_{o(tr)}$  is a fixed capacitance that gives the same charging time as  $C_{oss}$  while  $V_{DS}$  is rising from 0 to 80%  $V_{(BR)DSS}$

**Table 7 Reverse diode characteristics**

Parameter	Symbol	Values			Unit	Note / Test Condition
		Min.	Typ.	Max.		
Diode forward voltage	$V_{SD}$		0.9		V	$V_{GS} = 0V, I_F = 2.2A, T_j = 25^\circ C$
Reverse recovery time	$t_{rr}$		226		ns	$V_R = 400V, I_F = 2.2A,$ $di_F/dt = 100A/\mu s$ (see table 16)
Reverse recovery charge	$Q_{rr}$		1.3		$\mu C$	
Peak reverse recovery current	$I_{rrm}$		9.9		A	

## 5 Electrical characteristics diagrams

Table 8

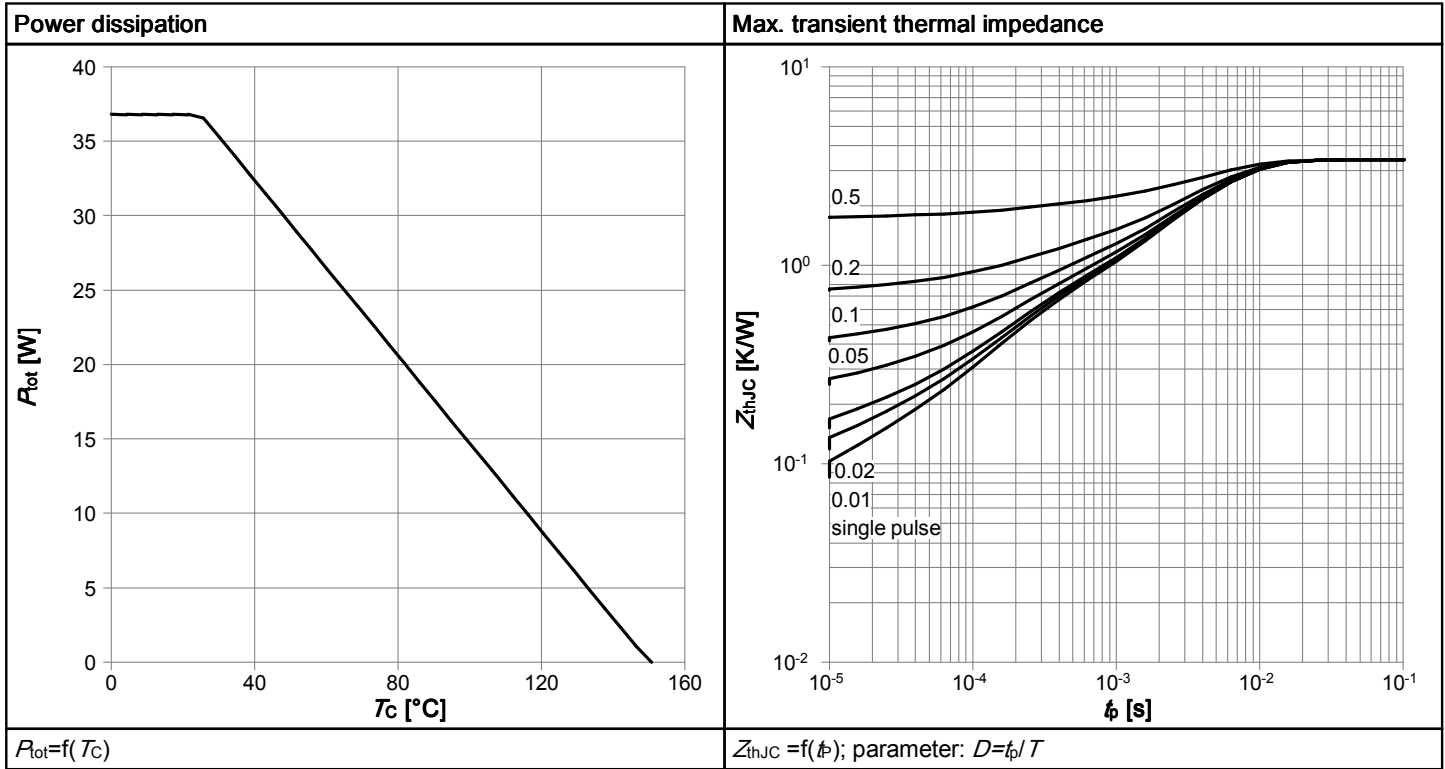

Table 9

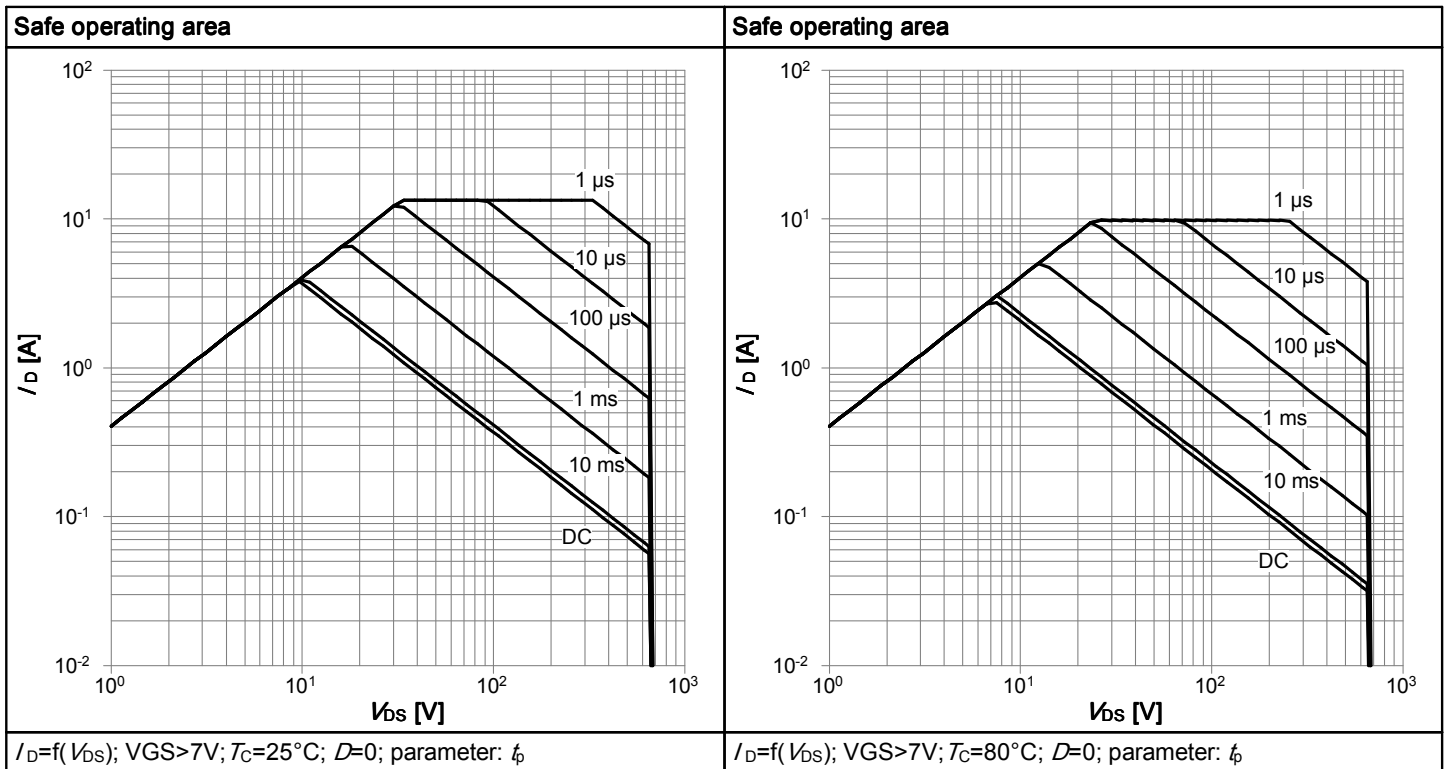

Table 10

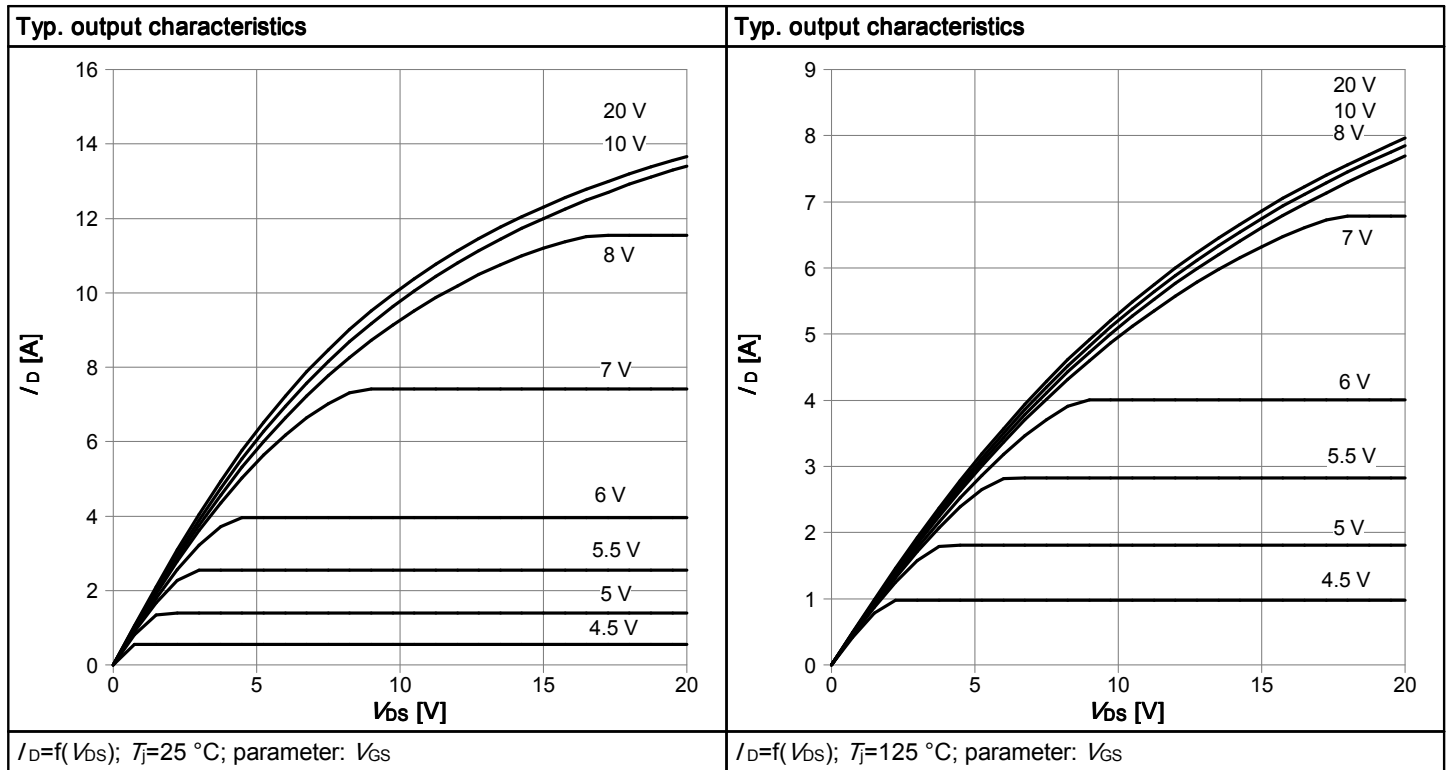

Table 11

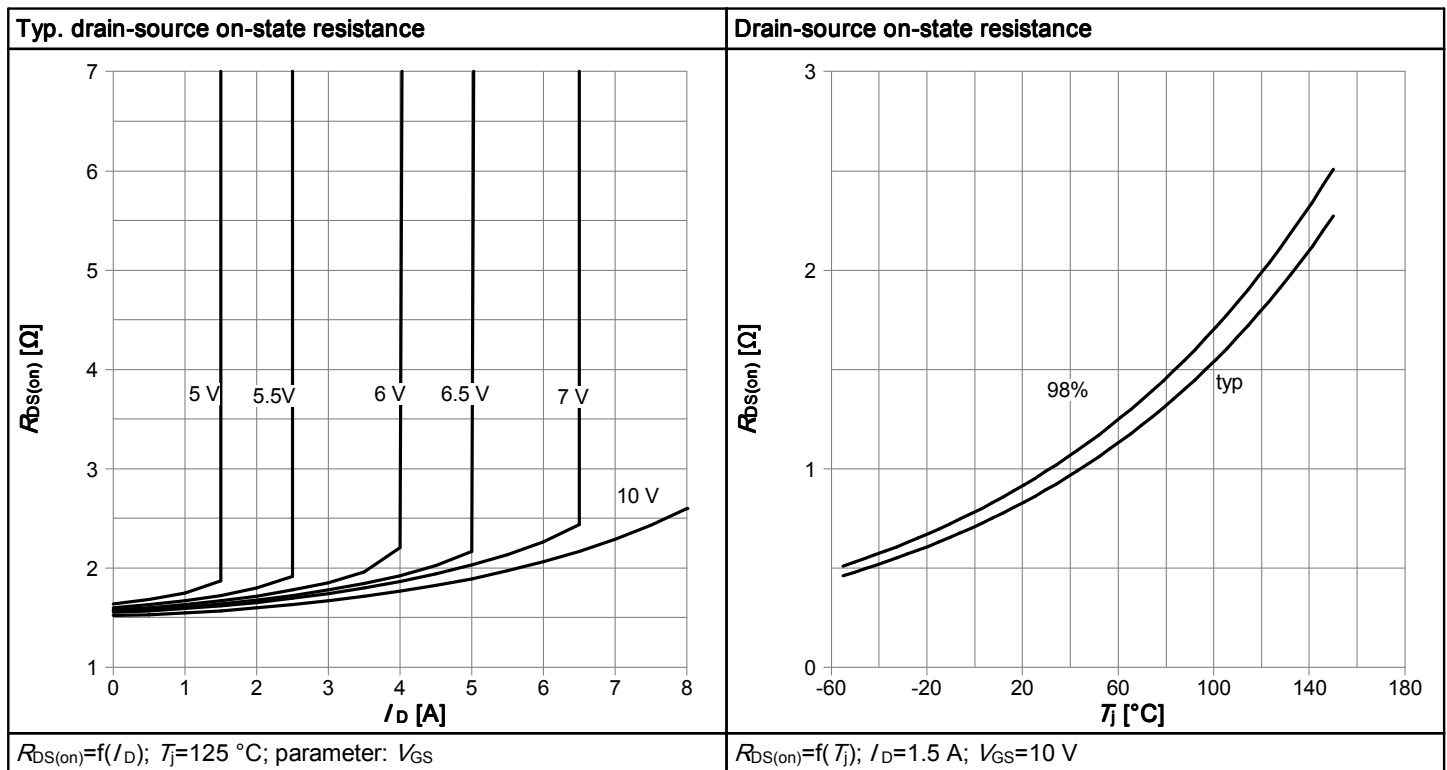

Table 12

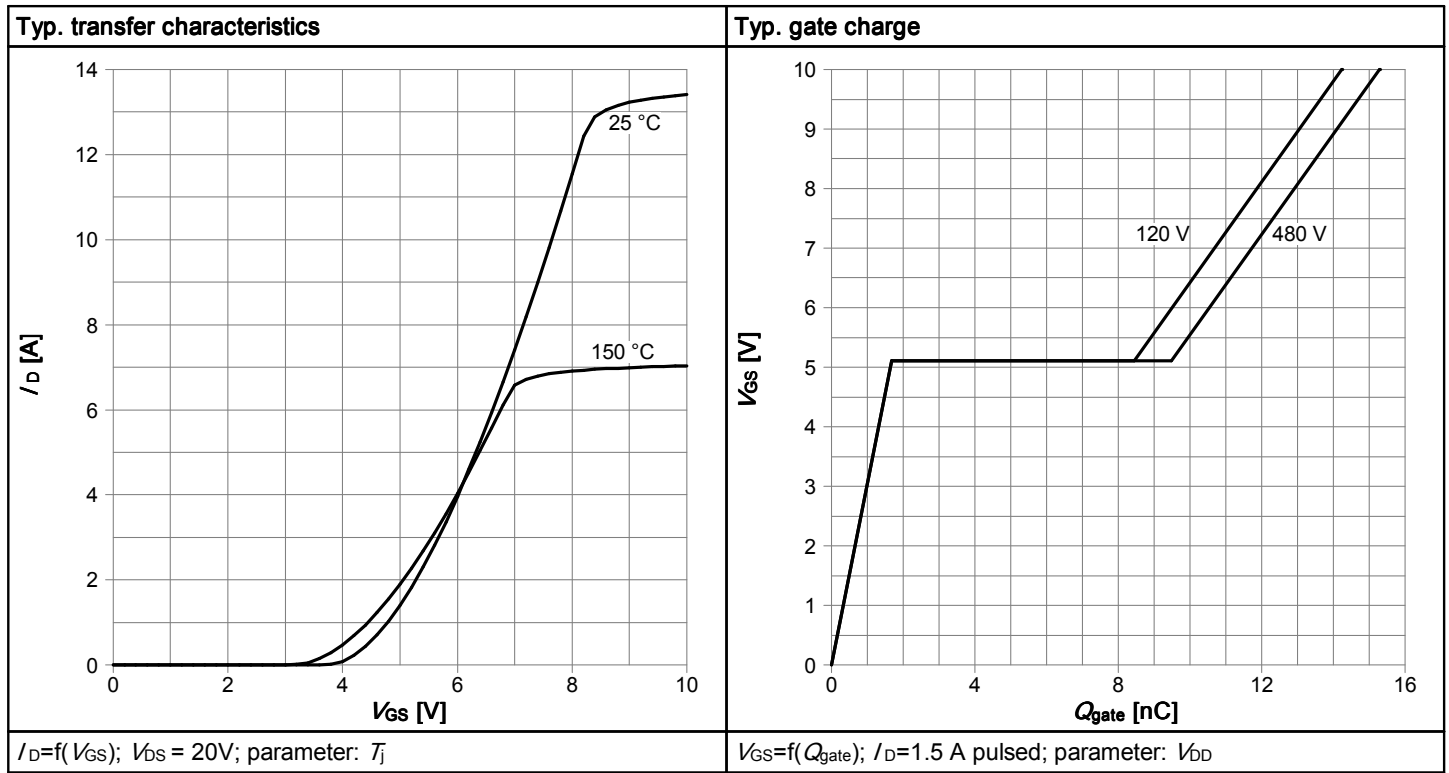

Table 13

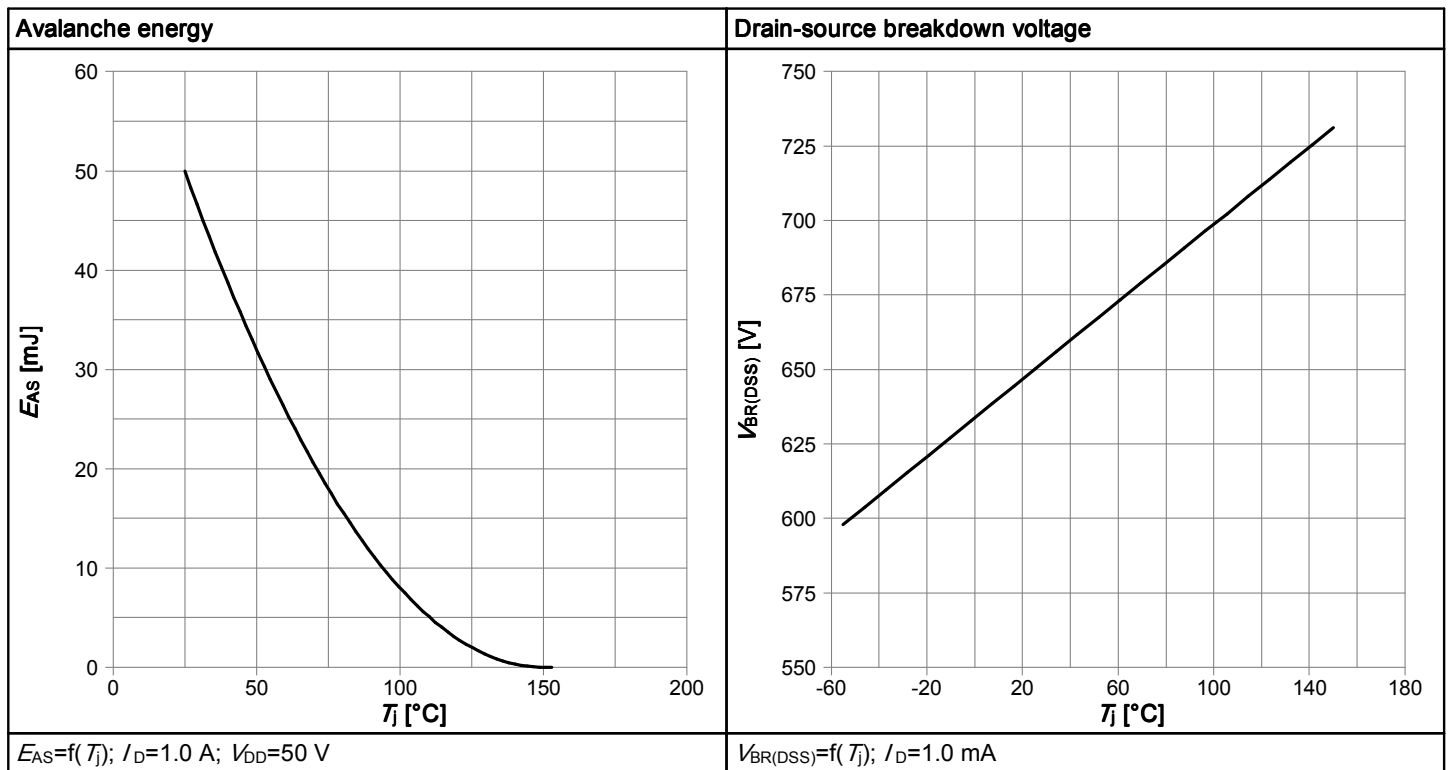

Table 14

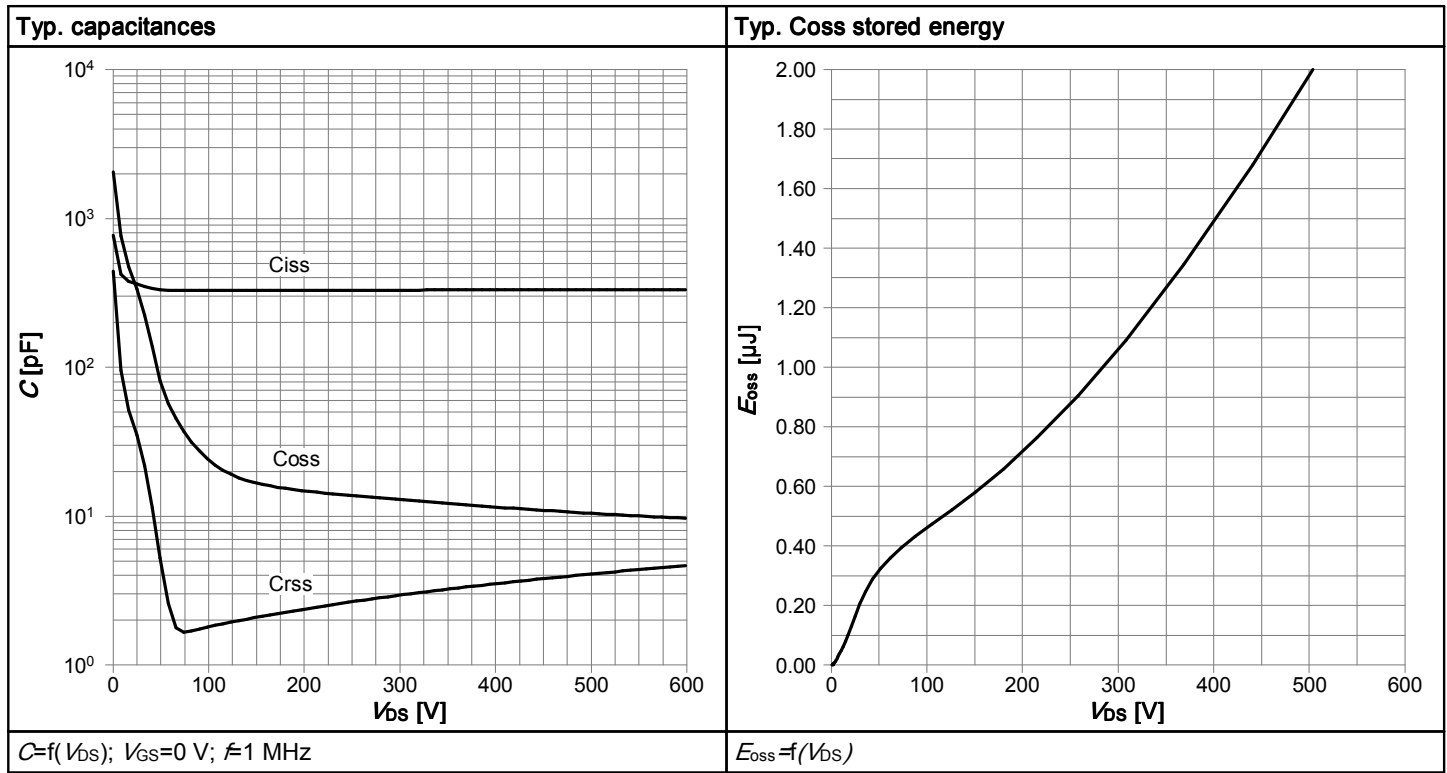
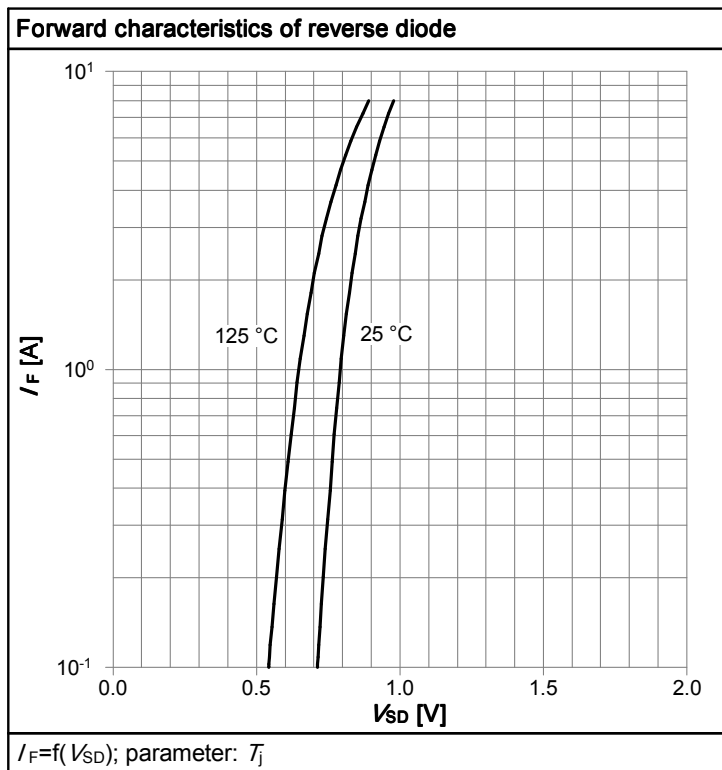

Table 15



6 Test Circuits

Table 16 Diode characteristics

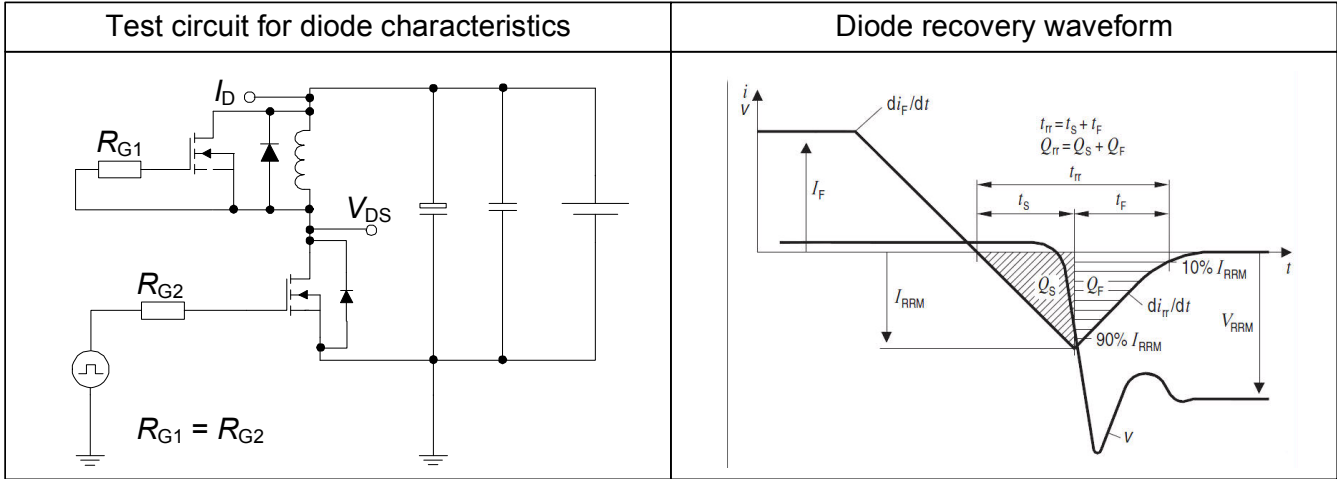

Table 17 Switching times

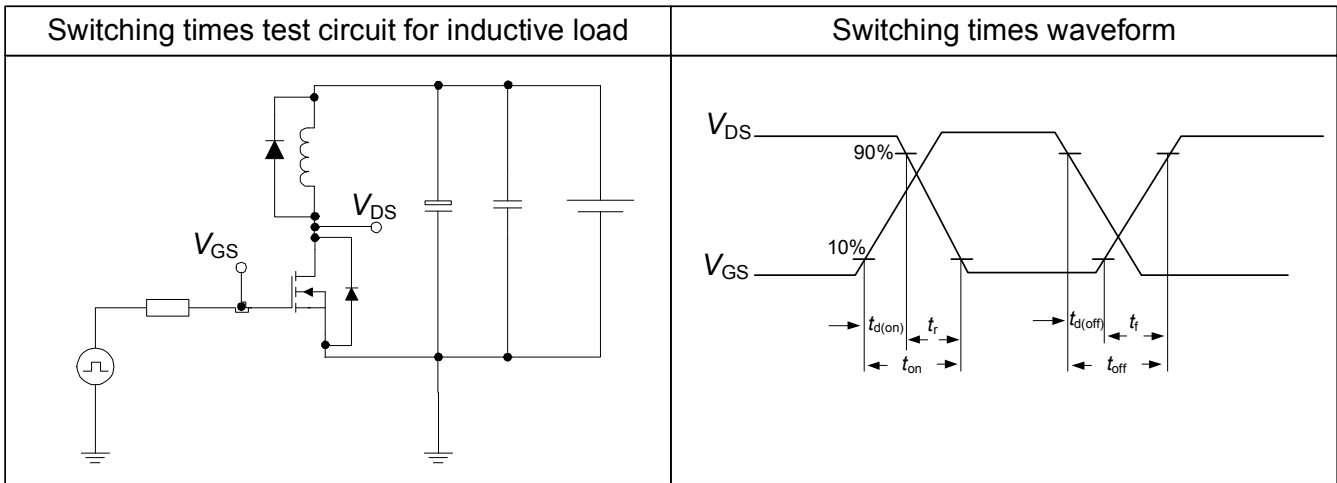
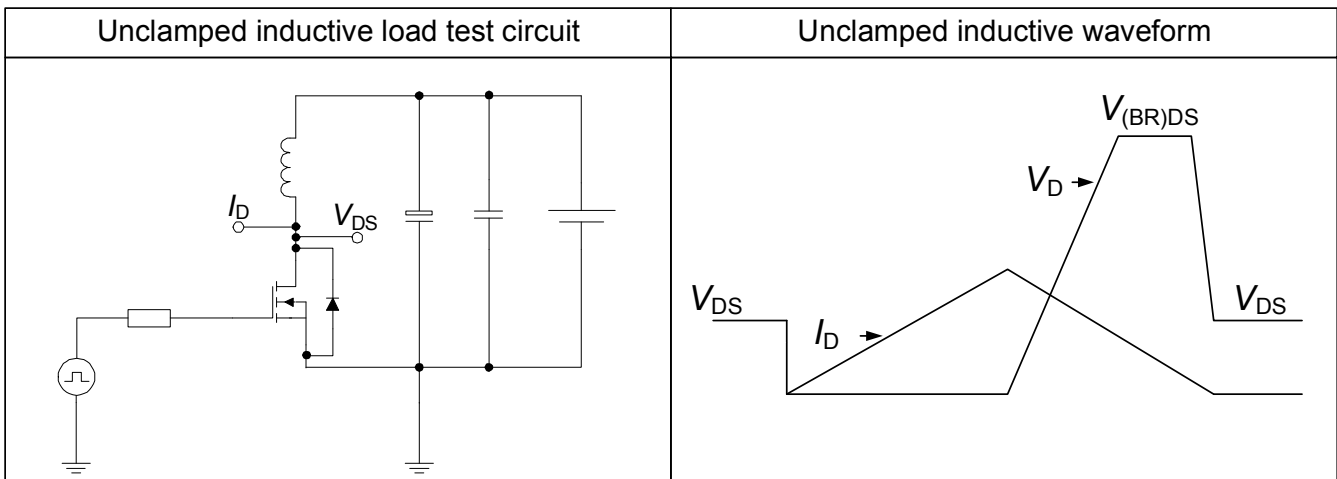
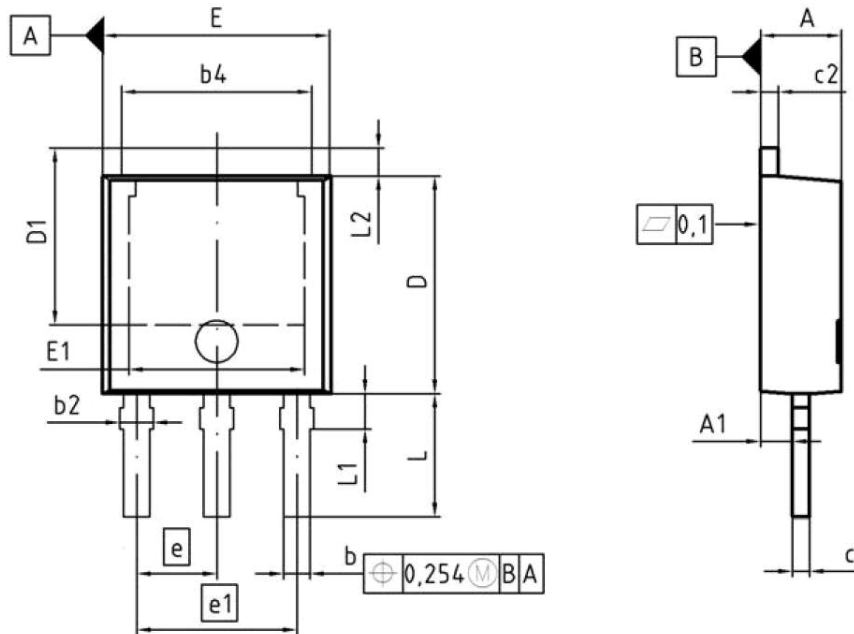

Table 18 Unclamped inductive



## 7 Package Outlines



DIM	MILLIMETERS		INCHES	
	MIN	MAX	MIN	MAX
A	2.18	2.39	0.086	0.094
A1	0.80	1.14	0.031	0.045
b	0.64	0.89	0.025	0.035
b2	0.65	1.15	0.026	0.045
b4	4.95	5.50	0.195	0.217
c	0.46	0.58	0.018	0.023
c2	0.46	0.89	0.018	0.035
D	5.97	6.22	0.235	0.245
D1	5.04	5.44	0.198	0.214
E	6.35	6.73	0.250	0.265
E1	4.90	5.10	0.193	0.201
e	2.29		0.090	
e1	4.57		0.180	
N	3		3	
L	3.30	3.50	0.130	0.138
L1	0.90	1.10	0.035	0.043
L2	0.90	1.10	0.035	0.043

DOCUMENT NO. Z8B00003329
SCALE 
EUROPEAN PROJECTION 
ISSUE DATE 05-07-2012
REVISION 04

Figure 1 Outline PG-TO 251, dimensions in mm/inches

## 8 Appendix A

### Table 19 Related Links

- **IFX C6 Product Brief:**

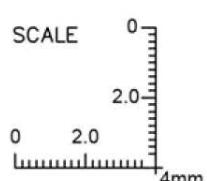
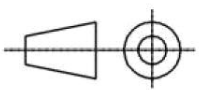
<http://www.infineon.com/dgdl/Product+Brief+600V+CoolMOS+C6+.pdf?folderId=db3a3043156fd5730115939eb6b506db&fileId=6891a14156fd5730115939eb6b506db&fromApp=portal>

- **IFX C6 Portfolio:**

[http://www.infineon.com/cms/en/product/findProductTypeByName.html?q=ip\\*c6](http://www.infineon.com/cms/en/product/findProductTypeByName.html?q=ip*c6)

- **IFX CoolMOS Webpage:**

<http://www.infineon.com/cms/en/product/channel.html?channel=ff80808112ab681d0112ab6a628704d8>

- **IFX Design Tools:**

<http://www.infineon.com/cms/en/product/promopages/designtools/index.html>

## Revision History

IPS65R950C6

**Revision: 2012-07-06, Rev. 2.0**

Previous Revision

Revision	Date	Subjects (major changes since last revision)
0.9	2011-12-19	Release of target datasheet
2.0	2012-07-06	Release of final version

### We Listen to Your Comments

Any information within this document that you feel is wrong, unclear or missing at all? Your feedback will help us to continuously improve the quality of this document. Please send your proposal (including a reference to this document) to:

[erratum@infineon.com](mailto:erratum@infineon.com)

**Edition 2011-08-01**

**Published by**

**Infineon Technologies AG**

**81726 München, Germany**

**© 2011 Infineon Technologies AG**

**All Rights Reserved.**

### Legal Disclaimer

The information given in this document shall in no event be regarded as a guarantee of conditions or characteristics. With respect to any examples or hints given herein, any typical values stated herein and/or any information regarding the application of the device, Infineon Technologies hereby disclaims any and all warranties and liabilities of any kind, including without limitation, warranties of non-infringement of intellectual property rights of any third party.

### Information

For further information on technology, delivery terms and conditions and prices please contact your nearest Infineon Technologies Office ([www.infineon.com](http://www.infineon.com)).

### Warnings

Due to technical requirements, components may contain dangerous substances. For information on the types in question, please contact the nearest Infineon Technologies Office.

The Infineon Technologies component described in this Data Sheet may be used in life-support devices or systems and/or automotive, aviation and aerospace applications or systems only with the express written approval of Infineon Technologies, if a failure of such components can reasonably be expected to cause the failure of that life-support, automotive, aviation and aerospace device or system or to affect the safety or effectiveness of that device or system. Life support devices or systems are intended to be implanted in the human body or to support and/or maintain and sustain and/or protect human life. If they fail, it is reasonable to assume that the health of the user or other persons may be endangered.

## Looking for pricing, stock, or lifecycle information?

Click below to explore more details on WIN SOURCE:

- ⊖ [View IPS65R950C6 on WIN SOURCE](#)
- ⊖ [Infineon Technologies Information](#)

## Optimize Your Supply Chain with WIN SOURCE Solutions

- ✓ Global Sourcing Solution
- ✓ Obsolete Management
- ✓ Cost Control Management
- ✓ Shortage Management
- ✓ Alternative Solution
- ✓ Excess Inventory Management