



**THE DATASHEET OF  
IR3447MTR1PBF**



## FEATURES

- Single 5V to 21V application
- Wide Input Voltage Range from 1.5V to 21V with external Vcc
- Output Voltage Range: 0.6V to 0.86\*P<sub>Vin</sub>
- 0.5% accurate Reference Voltage
- Enhanced line/load regulation with Feed-Forward
- Programmable Switching Frequency up to 1.5MHz
- Internal Digital Soft-Start
- Enable input with Voltage Monitoring Capability
- Remote Sense Amplifier with True Differential Voltage Sensing
- Thermally compensated current limit and Hiccup Mode Over Current Protection
- Smart LDO to enhance efficiency
- External synchronization with Smooth Clocking
- Dedicated output voltage sensing for power good indication and overvoltage protection which remains active even when Enable is low.
- Enhanced Pre-Bias Start up
- Body Braking to improve transient
- Integrated MOSFET drivers and Bootstrap diode
- Thermal Shut Down
- Post Package trimmed rising edge dead-time
- Programmable Power Good Output
- Small Size 5mm x 6mm PQFN
- Operating Junction Temp: -40°C < T<sub>j</sub> < 125°C
- Lead-free, Halogen-free and RoHS Compliant

## DESCRIPTION

The IR3447 Sup/IRBuck™ is an easy-to-use, fully integrated and highly efficient DC/DC regulator. The onboard PWM controller and MOSFETs make IR3447 a space-efficient solution, providing accurate power delivery for low output voltage and high current applications.

IR3447 is a versatile regulator which offers programmability of switching frequency and current limit while operating in wide input and output voltage range.

The switching frequency is programmable from 300 kHz to 1.5MHz for an optimum solution.

It also features important protection functions, such as Over Voltage Protection (OVP), Pre-Bias startup, hiccup current limit and thermal shutdown to give required system level security in the event of fault conditions.

## APPLICATIONS

- Server Application
- Distributed Point of Load Power Architectures
- Set Top Box Application
- Power Supplies

## ORDERING INFORMATION

| Base Part Number | Package Type   | Standard Pack |          | Orderable Part Number |
|------------------|----------------|---------------|----------|-----------------------|
|                  |                | Form          | Quantity |                       |
| IR3447           | PQFN 5mm x 6mm | Tape and Reel | 750      | IR3447MTR1PBF         |
| IR3447           | PQFN 5mm x 6mm | Tape and Reel | 4000     | IR3447MTRPBF          |

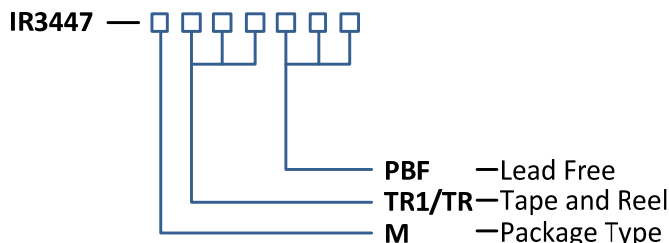



### FUNCTIONAL BLOCK DIAGRAM

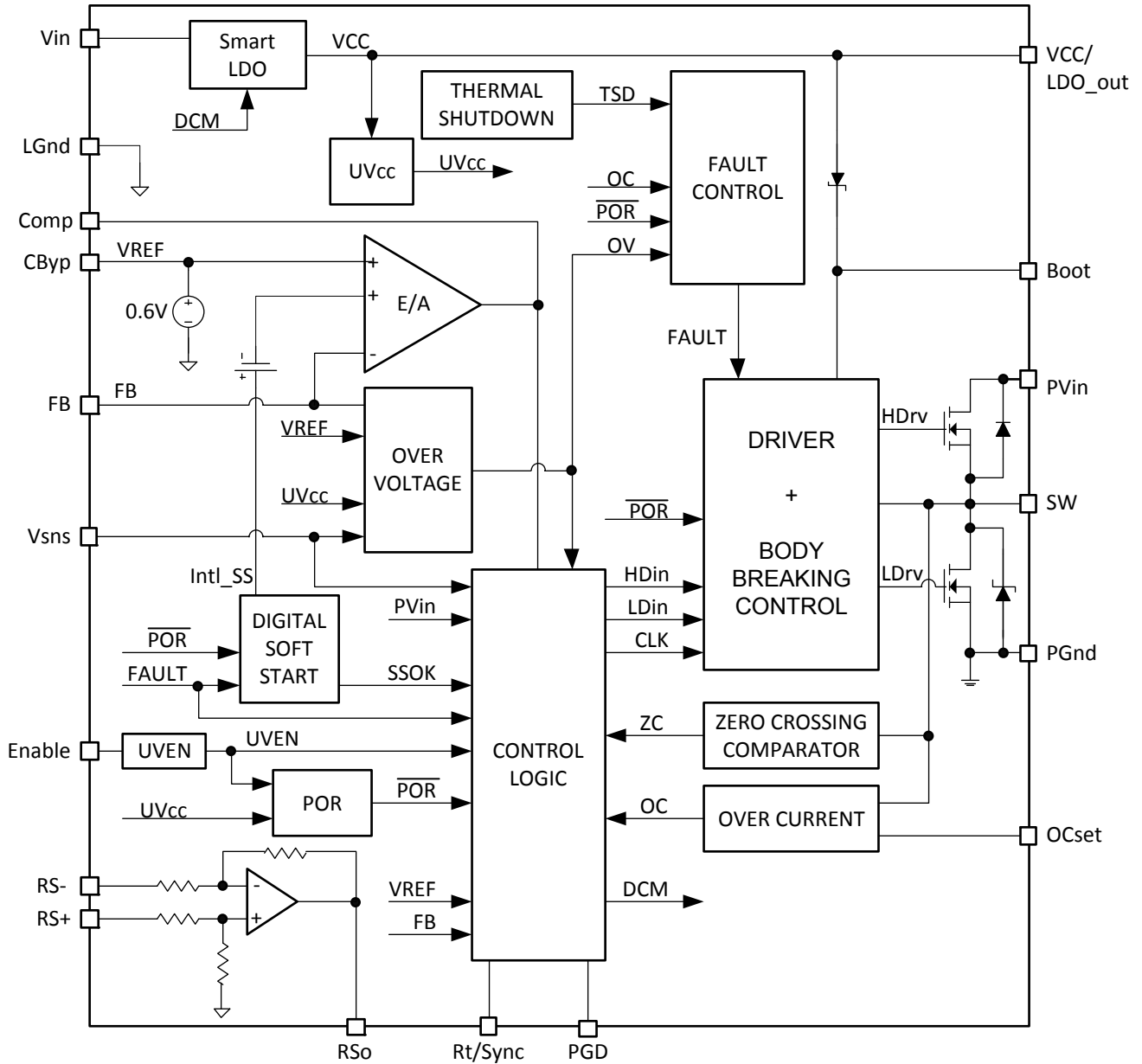

Figure 3: IR3447 Simplified Block Diagram

## PIN DESCRIPTIONS

| PIN #                      | PIN NAME               | PIN DESCRIPTION   |
|----------------------------|------------------------|---|
| 1                          | PVin                   | Input voltage for power stage. Bypass capacitors between PVin and PGND should be connected very close to this pin and PGND; also forms input to feedforward block   |
| 2                          | Boot                   | Supply voltage for high side driver   |
| 3                          | Enable                 | Enable pin to turning on and off the IC.  |
| 4                          | Rt/Sync                | Use an external resistor from this pin to LGND to set the switching frequency, very close to the pin. This pin can also be used for external synchronization.   |
| 5                          | OCset                  | Current Limit setpoint. This pin allows the trip point to be set to one of three possible settings by either floating this pin, tying it to VCC or tying it to PGnd.  |
| 6                          | Vsns                   | Sense pin for OVP and PGood   |
| 7                          | FB                     | Inverting input to the error amplifier. This pin is connected directly to the output of the regulator or to the output of the remote sense amplifier, via resistor divider to set the output voltage and provide feedback to the error amplifier. |
| 8                          | COMP                   | Output of error amplifier. An external resistor and capacitor network is typically connected from this pin to FB to provide loop compensation.  |
| 9                          | RS <sub>o</sub>        | Remote Sense Amplifier Output   |
| 10, 26, 27, 29             | PGND                   | Power ground. This pin should be connected to the system's power ground plane. Bypass capacitors between PVin and PGND should be connected very close to PVIN pin (pin 1) and this pin.   |
| 11                         | LGND                   | Signal ground for internal reference and control circuitry.   |
| 12                         | RS-                    | Remote Sense Amplifier input. Connect to ground at the load.  |
| 13                         | RS+                    | Remote Sense Amplifier input. Connect to output at the load.  |
| 14                         | CBy <sub>p</sub>       | Bypassing capacitor for internal reference voltage. A capacitor between 100pF and 180pF should be connected between this pin and LGnd.  |
| 15, 19, 28, 30, 31, 33     | NC                     | No connection.  |
| 16                         | PGD                    | Power Good status pin. Output is open drain. Connect a pull up resistor from this pin to VCC.   |
| 17                         | V <sub>in</sub>        | Input Voltage for LDO.  |
| 18                         | VCC/LDO <sub>out</sub> | Bias Voltage for IC and driver section, output of LDO. Add a minimum of 4.7uF bypass cap from this pin to PGnd.   |
| 20, 21, 22, 23, 24, 25, 32 | SW                     | Switch node. This pin is connected to the output inductor.  |

## ABSOLUTE MAXIMUM RATINGS

Stresses beyond those listed under “Absolute Maximum Ratings” may cause permanent damage to the device. These are stress ratings only and functional operation of the device at these or any other conditions beyond those indicated in the operational sections of the specifications are not implied.

|                                   |   |           |
|-----------------------------------|---|-----------|
| PVin                              | -0.3V to 25V                              |           |
| Vin                               | -0.3V to 25V                              |           |
| VCC                               | -0.3V to 8V (Note 1)                      |           |
| SW                                | -0.3V to 25V (DC), -4V to 25V (AC, 100ns) |           |
| BOOT                              | -0.3V to 33V                              |           |
| BOOT to SW                        | -0.3V to VCC + 0.3V (Note 2)              |           |
| Input/Output pins                 | -0.3V to 3.9V                             |           |
| RS+, RS-, RSo, PGD, Enable, OCset | -0.3V to 8V (Note 1)                      |           |
| PGND to LGND, RS- to LGND         | -0.3V to + 0.3V                           |           |
| Junction Temperature Range        | -40°C to 150°C                            |           |
| Storage Temperature Range         | -55°C to 150°C                            |           |
| ESD                               | Machine Model                             | Class A   |
|                                   | Human Body Model                          | Class 1C  |
|                                   | Charged Device Model                      | Class III |
| Moisture Sensitivity level        | JEDEC Level 3 @ 260°C                     |           |
| RoHS Compliant                    | Yes                                       |           |

**Note:**

1. VCC must not exceed 7.5V for Junction Temperature between -10°C and -40°C.
2. Must not exceed 8V.

### THERMAL INFORMATION

|  |          |
|--|----------|
| Thermal Resistance, Junction to Case Top ( $\theta_{JC\_TOP}$ )    | 31.5°C/W |
| Thermal Resistance, Junction to PCB ( $\theta_{JB}$ )              | 2.41°C/W |
| Thermal Resistance, Junction to Ambient ( $\theta_{JA}$ ) (Note 3) | 14.7°C/W |

**Note:**

3. Thermal resistance ( $\theta_{JA}$ ) is measured with components mounted on a high effective thermal conductivity test board.

## ELECTRICAL SPECIFICATIONS

### RECOMMENDED OPERATING CONDITIONS

| SYMBOL         | DEFINITION           | MIN | MAX         | UNITS |
|----------------|----------------------|-----|-------------|-------|
| PVin           | Input Bus Voltage *  | 1.5 | 21          | V     |
| Vin            | Supply Voltage       | 5.0 | 21          |       |
| VCC            | Supply Voltage **    | 4.5 | 7.5         |       |
| Boot to SW     | Supply Voltage       | 4.5 | 7.5         |       |
| V <sub>O</sub> | Output Voltage       | 0.6 | 0.86 * PVin |       |
| I <sub>O</sub> | Output Current       | 0   | ±25         | A     |
| Fs             | Switching Frequency  | 300 | 1500        | kHz   |
| T <sub>J</sub> | Junction Temperature | -40 | 125         | °C    |

\* SW node must not exceed 25V

\*\* When VCC is connected to an externally regulated supply, also connect Vin.

### ELECTRICAL CHARACTERISTICS

Unless otherwise specified, these specification apply over, 1.5V < PVin < 21V, 4.5V < VCC < 7.5V, 0°C < T<sub>J</sub> < 125°C.

Typical values are specified at T<sub>A</sub> = 25°C.

| PARAMETER                                | SYMBOL                   | CONDITIONS   | MIN  | TYP  | MAX  | UNIT |
|--|--------------------------|--|------|------|------|------|
| <b>Power Loss</b>                        |                          |  |      |      |      |      |
| Power Loss                               | P <sub>LOSS</sub>        | V <sub>in</sub> = PV <sub>in</sub> = 12V, V <sub>O</sub> = 1.2V, I <sub>O</sub> = 25A, Fs = 600kHz, L=0.215uH, T <sub>A</sub> = 25°C, Note 4 |      | 3.62 |      | W    |
| <b>MOSFET R<sub>ds(on)</sub></b>         |                          |  |      |      |      |      |
| Top Switch                               | Rds(on)_Top              | V <sub>Boot</sub> - V <sub>SW</sub> = 6.8V, I <sub>D</sub> = 25A, T <sub>J</sub> = 25°C  |      | 4    | 5.2  | mΩ   |
| Bottom Switch                            | Rds(on)_Bot              | VCC = 6.8V, I <sub>D</sub> = 25A, T <sub>J</sub> = 25°C  |      | 1.8  | 2.3  |      |
| <b>Reference Voltage</b>                 |                          |  |      |      |      |      |
| Feedback Voltage                         | V <sub>FB</sub>          |  |      | 0.6  |      | V    |
| Accuracy                                 |                          | Vref=0.6V, 0°C < T <sub>J</sub> < 105°C  | -0.5 |      | +0.5 | %    |
|  |                          | Vref=0.6V, -40°C < T <sub>J</sub> < 125°C  | -1.0 |      | +1.0 |      |
| <b>Supply Current</b>                    |                          |  |      |      |      |      |
| V <sub>in</sub> Supply Current (Standby) | I <sub>in(Standby)</sub> | Vin=21V, Enable low, No Switching  |      | 300  | 425  | μA   |
| V <sub>in</sub> Supply Current (Dyn)     | I <sub>in(Dyn)</sub>     | Vin=21V, Enable high, Fs = 600kHz  |      |      | 40   | mA   |
| VCC Supply Current (Standby)             | I <sub>cc(Standby)</sub> | Enable low, VCC=7V, No Switching   |      | 300  | 425  | μA   |

| PARAMETER                    | SYMBOL            | CONDITIONS                                   | MIN  | TYP  | MAX  | UNIT   |
|------------------------------|-------------------|--|------|------|------|--------|
| VCC Supply Current (Dyn)     | $I_{cc(Dyn)}$     | Enable high, VCC=7V, Fs = 600kHz             |      |      | 40   | mA     |
| <b>Under Voltage Lockout</b> |                   |  |      |      |      |        |
| VCC–Start–Threshold          | VCC_UVLO_Start    | VCC Rising Trip Level                        | 4.0  | 4.2  | 4.4  | V      |
| VCC–Stop–Threshold           | VCC_UVLO_Stop     | VCC Falling Trip Level                       | 3.8  | 3.9  | 4.2  |        |
| Enable–Start–Threshold       | Enable_UVLO_Start | Supply ramping up                            | 1.14 | 1.2  | 1.36 | V      |
| Enable–Stop–Threshold        | Enable_UVLO_Stop  | Supply ramping down                          | 0.9  | 1.0  | 1.06 |        |
| Enable leakage current       | Ien               | Enable=3.3V                                  |      |      | 1    | μA     |
| <b>Oscillator</b>            |                   |  |      |      |      |        |
| Rt Voltage                   |                   |  |      | 1    |      | V      |
| Frequency Range              | Fs                | Rt=80.6k                                     | 270  | 300  | 330  | kHz    |
|                              |                   | Rt=39.2k                                     | 540  | 600  | 660  |        |
|                              |                   | Rt=15k                                       | 1350 | 1500 | 1650 |        |
| Ramp Amplitude               | Vramp             | PVin=6.8V, PVin(max) slew rate=1V/us, Note 4 |      | 1.02 |      | Vp-p   |
|                              |                   | PVin=12V, PVin(max) slew rate=1V/us, Note 4  |      | 1.8  |      |        |
|                              |                   | PVin=16V, PVin(max) slew rate=1V/us, Note 4  |      | 2.4  |      |        |
| Ramp Offset                  | Ramp (os)         | Note 4                                       |      | 0.16 |      | V      |
| Min Pulse Width              | Tmin (ctrl)       | Note 4                                       |      |      | 50   | ns     |
| Fixed Off Time               |                   | Note 4                                       |      | 200  | 230  | ns     |
| Max Duty Cycle               | Dmax              | Fs=300kHz, PVin=Vin=12V                      | 86   |      |      | %      |
| Sync Frequency Range         |                   | Note 4                                       | 270  |      | 1650 | kHz    |
| Sync Pulse Duration          |                   |  | 100  | 200  |      | ns     |
| Sync Level Threshold         | High              |  | 3    |      |      | V      |
|                              | Low               |  |      |      | 0.6  |        |
| <b>Error Amplifier</b>       |                   |  |      |      |      |        |
| Input Offset Voltage         | Vos_CByp          | VFb – VREF, VREF = 0.6V                      | -1.5 |      | +1.5 | %      |
| Input Bias Current           | IFb(E/A)          |  | -0.5 |      | +0.5 | μA     |
| Sink Current                 | Isink(E/A)        |  | 0.4  | 0.85 | 1.2  | mA     |
| Source Current               | Isource(E/A)      |  | 4    | 5    | 11   | mA     |
| Slew Rate                    | SR                | Note 4                                       | 7    | 12   | 20   | V / μs |
| Gain-Bandwidth Product       | GBWP              | Note 4                                       | 20   | 30   | 40   | MHz    |
| DC Gain                      | Gain              | Note 4                                       | 100  | 110  | 120  | dB     |

| PARAMETER                                  | SYMBOL         | CONDITIONS   | MIN  | TYP      | MAX | UNIT         |
|--|----------------|--|------|----------|-----|--------------|
| Maximum Output Voltage                     | Vmax(E/A)      |  | 1.7  | 2        | 2.3 | V            |
| Minimum Output Voltage                     | Vmin(E/A)      |  |      |          | 100 | mV           |
| Common Mode Voltage                        | Vcm_Vp         | Note 4   | 0    |          | 1.2 | V            |
| <b>Remote Sense Differential Amplifier</b> |                |  |      |          |     |              |
| Unity Gain Bandwidth                       | BW_RS          | Note 4   | 3    | 6.4      | 9   | MHz          |
| DC Gain                                    | Gain_RS        | Note 4   |      | 110      |     | dB           |
| Offset Voltage                             | Offset_RS      | VREF=0.6V,<br>0°C < Tj < 85°C                          | -1.5 | 0        | 1.5 | mV           |
|  |                | VREF=0.6V,<br>-40°C < Tj < 125°C                       | -2   |          | 2   | mV           |
| Source Current                             | Isource_RS     |  | 3    | 13       | 20  | mA           |
| Sink Current                               | Isink_RS       |  | 0.4  | 1        | 2   | mA           |
| Slew Rate                                  | Slew_RS        | Note 4, Cload = 100pF                                  | 2    | 4        | 8   | V / $\mu$ s  |
| RS+ input impedance                        | Rin_RS+        |  | 45   | 63       | 85  | kohm         |
| RS- input impedance                        | Rin_RS-        | Note 4   |      | 63       |     | kohm         |
| Maximum Voltage                            | Vmax_RS        | V(VCC) – V(RSo)  | 0.5  | 1        | 1.5 | V            |
| Minimum Voltage                            | Min_RS         |  |      | 50       |     | mV           |
| <b>Internal Digital Soft Start</b>         |                |  |      |          |     |              |
| Soft Start Clock                           | Clk_SS         | Note 4   | 180  | 200      | 220 | kHz          |
| Soft Start Ramp Rate                       | Ramp(SS_Start) | Note 4   | 0.3  | 0.4      | 0.5 | mV / $\mu$ s |
| <b>Bootstrap Diode</b>                     |                |  |      |          |     |              |
| Forward Voltage                            |                | I(Boot) = 30mA   | 360  | 520      | 960 | mV           |
| <b>Switch Node</b>                         |                |  |      |          |     |              |
| SW Leakage Current                         | Isw            | SW = 0V, Enable = 0V                                   |      |          | 1   | $\mu$ A      |
| <b>Internal Regulator (VCC/LDO)</b>        |                |  |      |          |     |              |
| Output Voltage                             | VCC            | Vin(min) = 7.2V, Io=0-30mA, Cload = 2.2 $\mu$ F, DCM=0 | 6.3  | 6.8      | 7.1 | V            |
|  |                | Vin(min) = 7.2V, Io=0-30mA, Cload = 2.2 $\mu$ F, DCM=1 | 4    | 4.4      | 4.8 |              |
| VCC dropout                                | VCC_drop       | Vin = 7V, Io=70 mA, Cload = 2.2 $\mu$ F                |      |          | 0.7 | V            |
| Short Circuit Current                      | Ishort         | Note 4   |      | 70       |     | mA           |
| Zero-crossing Comparator Delay             | Tdly_zc        |  |      | 256 / Fs |     | s            |
| Zero-crossing Comparator Offset            | Vos_zc         | Note 4   |      | 0        |     | mV           |

| PARAMETER                                    | SYMBOL              | CONDITIONS  | MIN   | TYP   | MAX   | UNIT   |
|--|---------------------|---|-------|-------|-------|--------|
| <b>Body Braking</b>                          |                     |   |       |       |       |        |
| BB Threshold                                 | BB_threshold        | Fb > Vref, SW duty cycle, Note 3                  |       | 0     |       | %      |
| <b>FAULTS</b>                                |                     |   |       |       |       |        |
| <b>Power Good</b>                            |                     |   |       |       |       |        |
| Power Good Low Upper Threshold               | VPG_low(upper)      | Vsns Rising                                       | 115   | 120   | 125   | % VREF |
| Power Good Low Upper Threshold Falling delay | VPG_low(upper)_Dly  | Vsns > VPG_low(upper)                             | 1.5   | 2.5   | 3.5   | μs     |
| Power Good High Lower Threshold              | VPG_high(lower)     | Vsns Rising                                       |       | 95    |       | % VREF |
| Power Good High Lower Threshold Rising Delay | VPG_high(lower)_Dly | Vsns rising                                       |       | 1.28  |       | ms     |
| Power Good Low Lower Threshold               | VPG_low(lower)      | Vsns falling                                      |       | 90    |       | % VREF |
| Power Good Low Lower Threshold Falling Delay | VPG_low(lower)_Dly  | Vsns < VPG_low(lower)                             | 101   | 150   | 199   | μs     |
| PGood Voltage Low                            | PG (voltage)        | I <sub>PGood</sub> = -5mA                         |       |       | 0.5   | V      |
| <b>Over Voltage Protection (OVP)</b>         |                     |   |       |       |       |        |
| OVP Trip Threshold                           | OVP (trip)          | Vsns Rising                                       | 115   | 120   | 125   | % VREF |
| OVP Fault Prop Delay                         | OVP (delay)         | Vsns rising                                       | 1.5   | 2.5   | 3.5   | μs     |
| <b>Over-Current Protection</b>               |                     |   |       |       |       |        |
| OC Trip Current                              | I <sub>TRIP</sub>   | OCSet=VCC, VCC = 6.8V, T <sub>J</sub> = 25°C      | 29.25 | 32.5  | 35.75 | A      |
|  |                     | OCSet=floating, VCC = 6.8V, T <sub>J</sub> = 25°C | 23.4  | 26    | 28.6  | A      |
|  |                     | OCSet=PGnd, VCC =6.8V, T <sub>J</sub> = 25°C      | 17.55 | 19.5  | 21.85 | A      |
| Hiccup blanking time                         | Tblk_Hiccup         | Note 4  |       | 20.48 |       | ms     |
| <b>Thermal Shutdown</b>                      |                     |   |       |       |       |        |
| Thermal Shutdown                             |                     | Note 4  |       | 145   |       | °C     |
| Hysteresis                                   |                     | Note 4  |       | 20    |       | °C     |

**Notes:**

4. Guaranteed by design but not tested in production.

## TYPICAL EFFICIENCY AND POWER LOSS CURVES

$P_{Vin} = V_{in} = 12V$ ,  $V_{CC} = \text{Internal LDO}$ ,  $I_o = 0-25A$ ,  $F_s = 600kHz$ , Room Temperature, No Air Flow. Note that the losses of the inductor, input and output capacitors are also considered in the efficiency and power loss curves. The table below shows the inductor used for each of the output voltages in the efficiency measurement.

| VOUT (V) | LOUT (uH) | P/N                           | DCR (mΩ) |
|----------|-----------|-------------------------------|----------|
| 1.0      | 0.215     | PCDC1008-R215EMO (Cyntec)     | 0.29     |
| 1.2      | 0.215     | PCDC1008-R215EMO (Cyntec)     | 0.29     |
| 1.8      | 0.311     | FP1109-R33-R (Coiltronics)    | 0.42     |
| 3.3      | 0.68      | 7443320068 (Wurth Elektronik) | 0.72     |

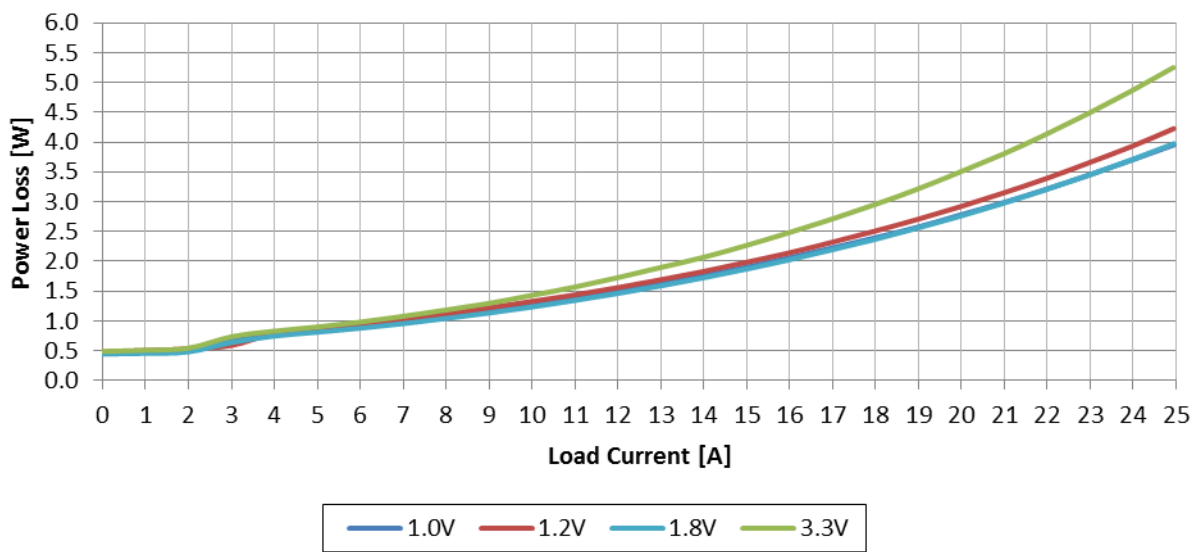
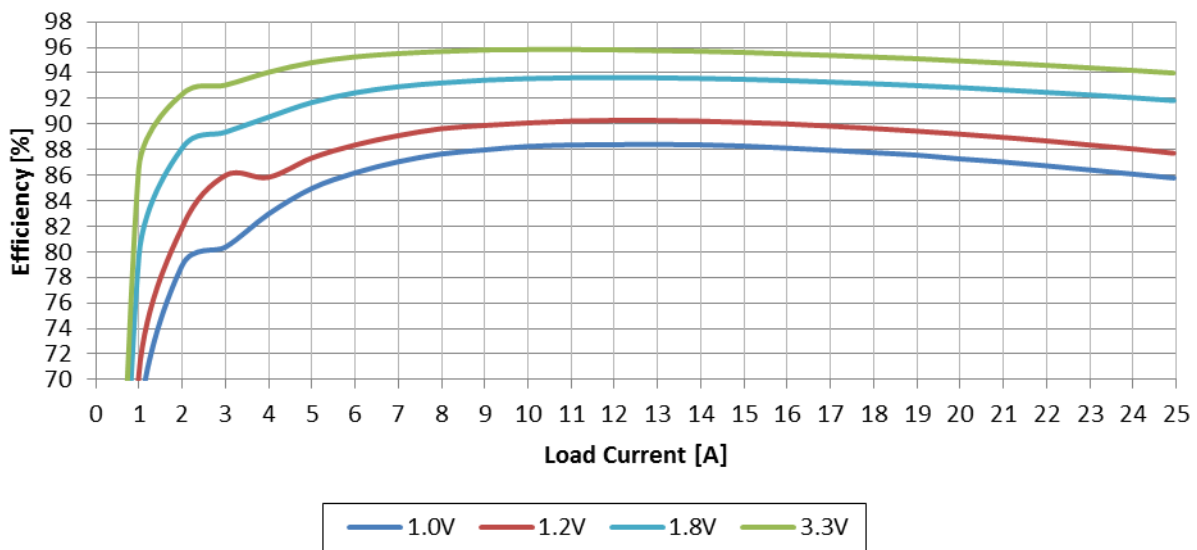

## TYPICAL EFFICIENCY AND POWER LOSS CURVES

$P_{Vin} = 12V$ ,  $V_{in} = V_{CC} = 5V$ ,  $I_o=0-25A$ ,  $F_s= 600kHz$ , Room Temperature, No Air Flow. Note that the losses of the inductor, input and output capacitors are also considered in the efficiency and power loss curves. The table below shows the indicator used for each of the output voltages in the efficiency measurement.

| VOUT (V) | LOUT (uH) | P/N                           | DCR (mΩ) |
|----------|-----------|-------------------------------|----------|
| 1.0      | 0.215     | PCDC1008-R215EMO (Cyntec)     | 0.29     |
| 1.2      | 0.215     | PCDC1008-R215EMO (Cyntec)     | 0.29     |
| 1.8      | 0.311     | FP1109-R33-R (Coiltronics)    | 0.42     |
| 3.3      | 0.68      | 7443320068 (Wurth Elektronik) | 0.72     |

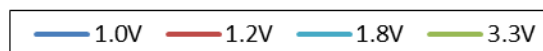
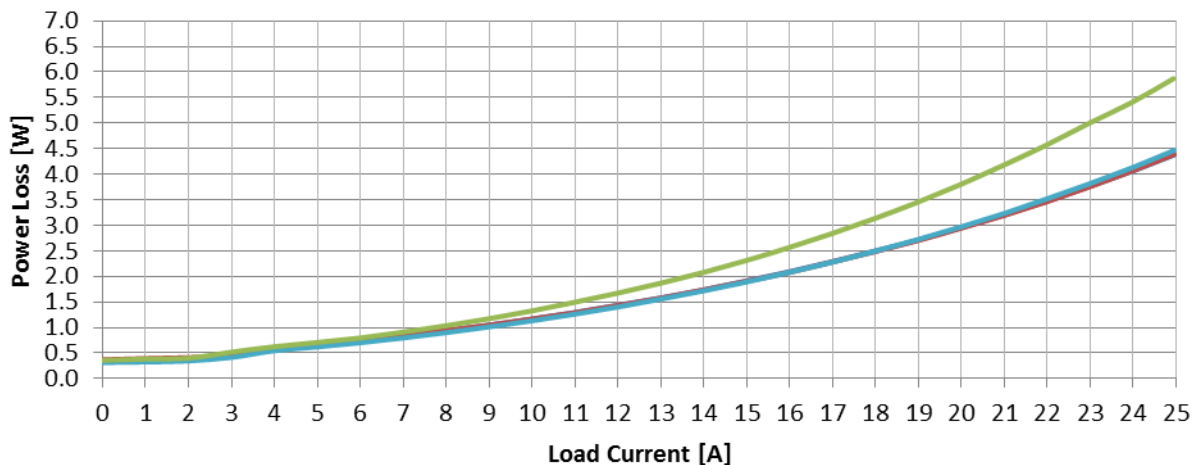
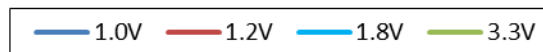
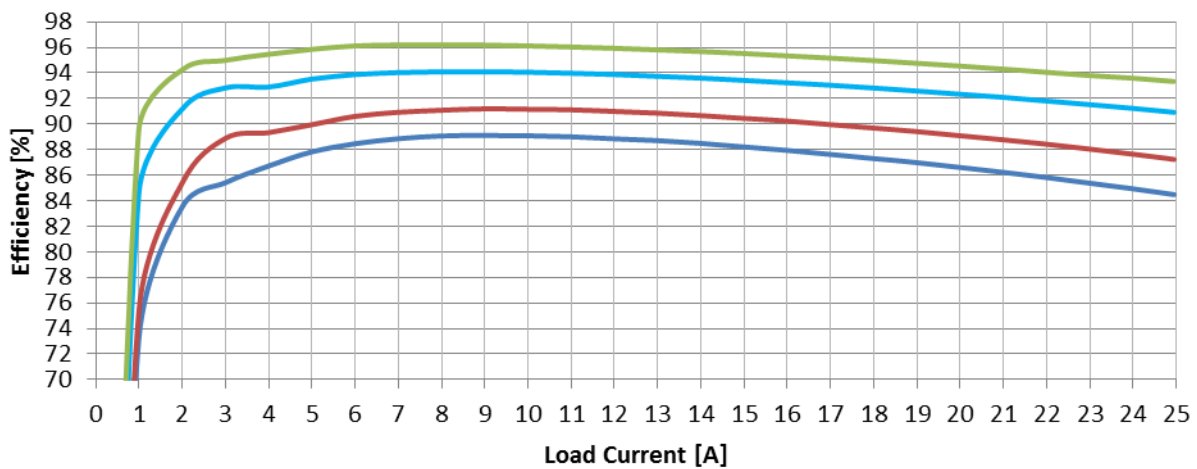

## TYPICAL EFFICIENCY AND POWER LOSS CURVES

$P_{Vin} = V_{in} = V_{CC} = 5V$ ,  $I_o=0-25A$ ,  $F_s= 600kHz$ , Room Temperature, No Air Flow. Note that the losses of the inductor, input and output capacitors are also considered in the efficiency and power loss curves. The table below shows the indicator used for each of the output voltages in the efficiency measurement.

| VOUT (V) | LOUT (uH) | P/N                        | DCR (mΩ) |
|----------|-----------|----------------------------|----------|
| 1.0      | 0.215     | PCDC1008-R215EMO (Cyntec)  | 0.29     |
| 1.2      | 0.215     | PCDC1008-R215EMO (Cyntec)  | 0.29     |
| 1.8      | 0.311     | FP1109-R33-R (Coiltronics) | 0.42     |

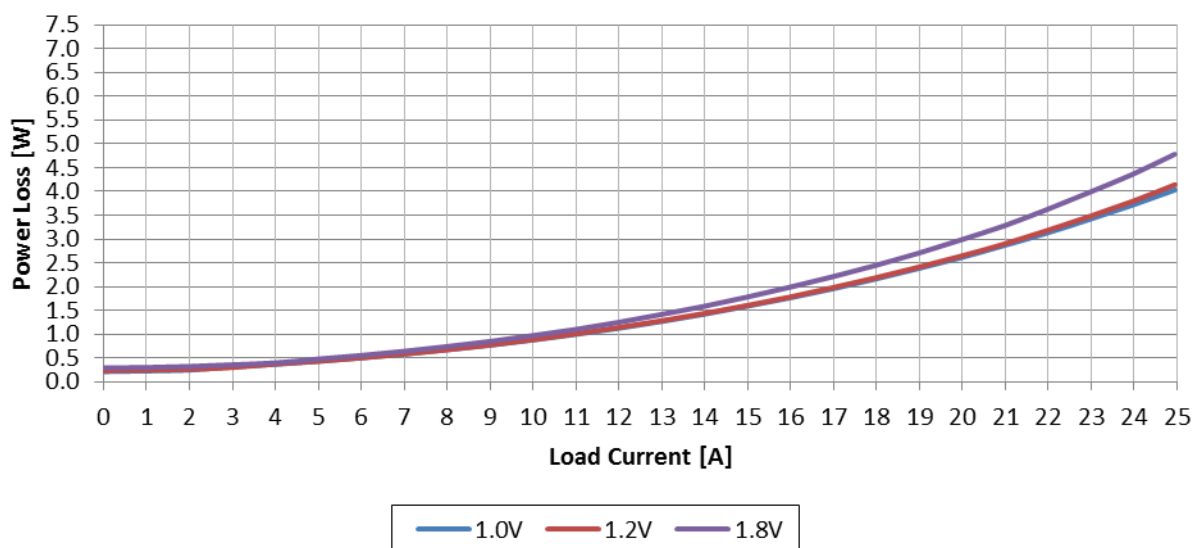
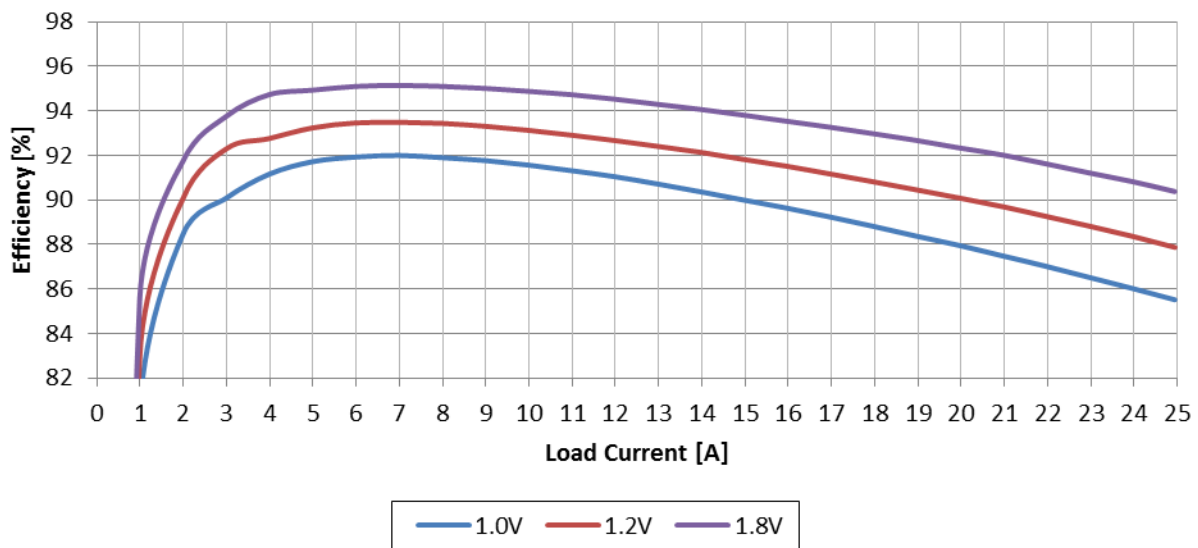

## THERMAL DERATING CURVES

Measurements are done on IR3447 Evaluation board. PCB is a 6 layer board with 2 oz copper, FR4 material.

$V_{in}=P_{Vin}=12V$ ,  $V_{out} = 1.2V$ ,  $V_{CC}=\text{internal LDO (6.8V)}$ ,  $F_s = 600\text{kHz}$

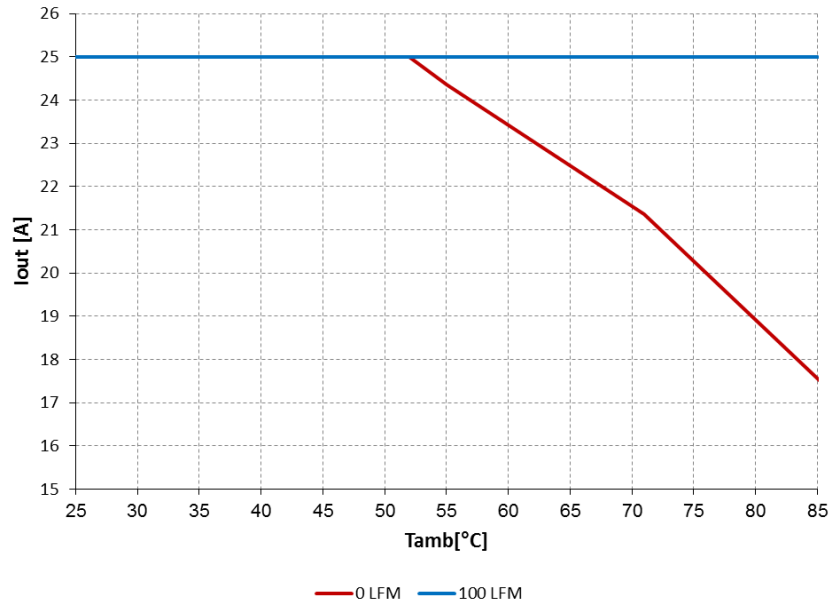

$V_{in}=P_{Vin}=12V$ ,  $V_{out} = 5.0V$ ,  $V_{CC}=\text{internal LDO (6.8V)}$ ,  $F_s = 600\text{kHz}$

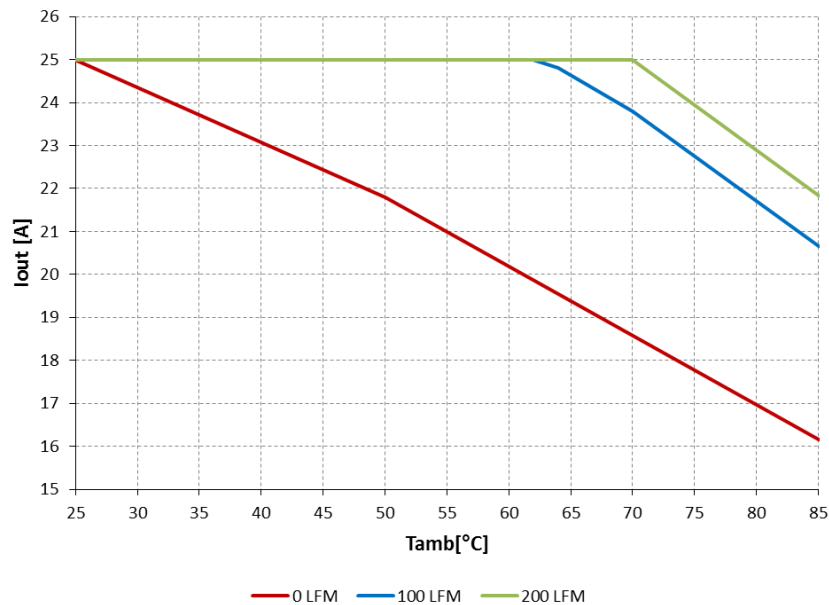

Note: International Rectifier Corporation specifies current rating of SupIRBuck devices conservatively. The continuous current load capability might be higher than the rating of the device if input voltage is 12V typical and switching frequency is below 600kHz. However, the maximum current is limited by the internal current limit and designers need to consider enough guard bands between load current and minimum current limit to guarantee that the device does not trip at steady state condition.

## MOSFET RDSON VARIATION OVER TEMPERATURE

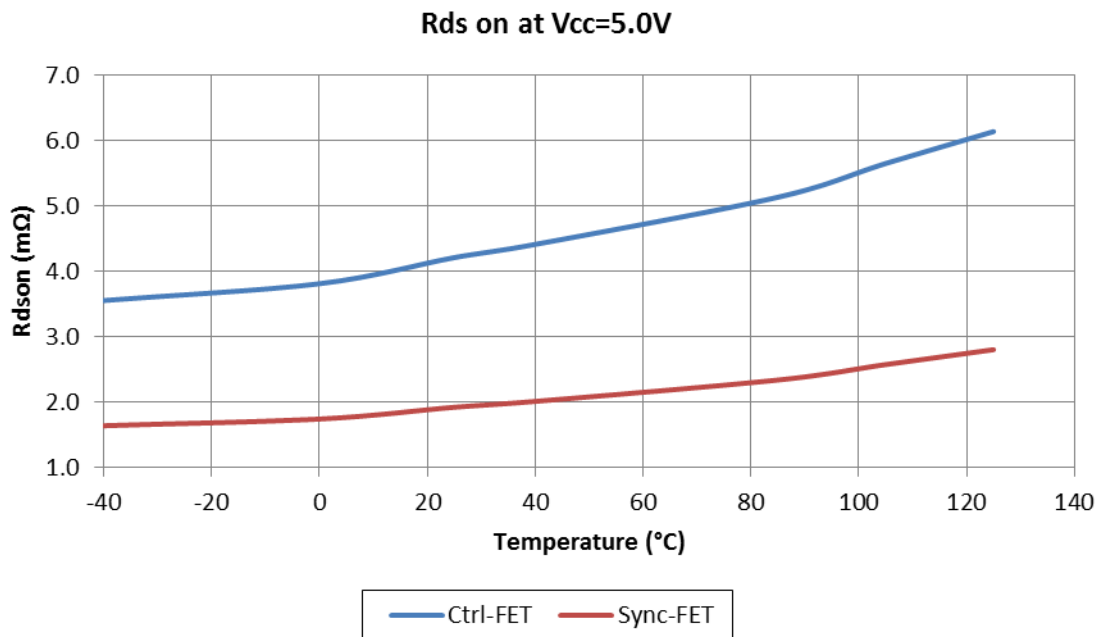
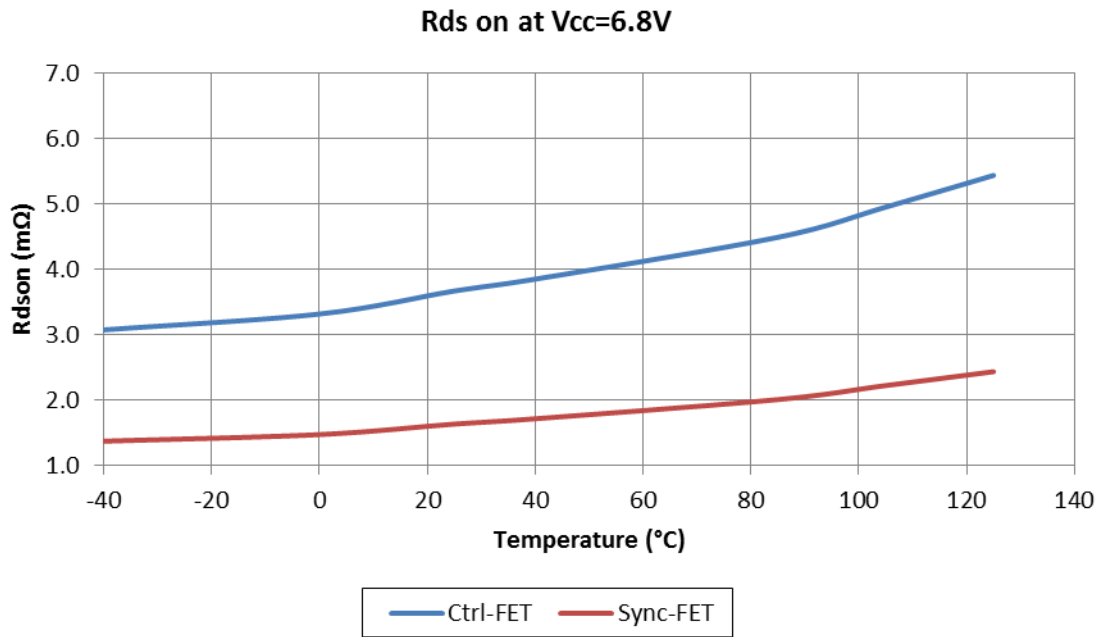

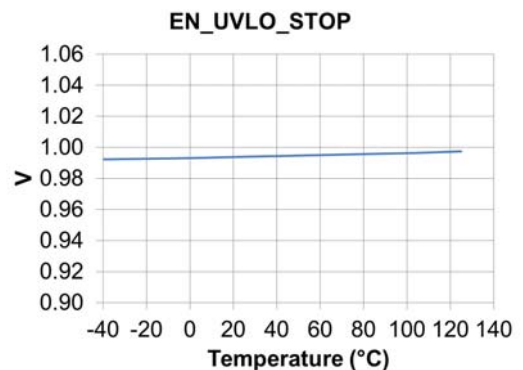
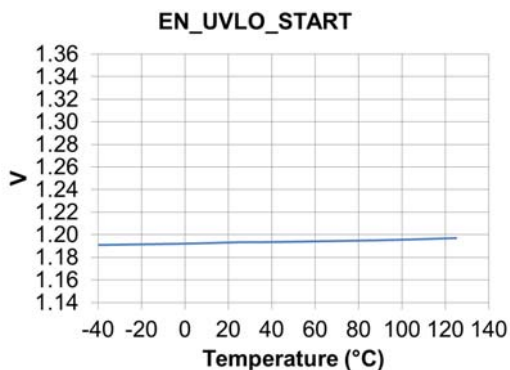
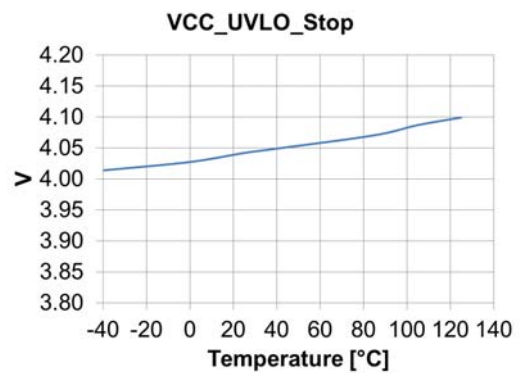
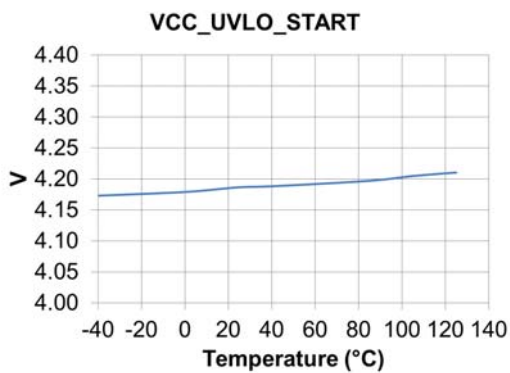
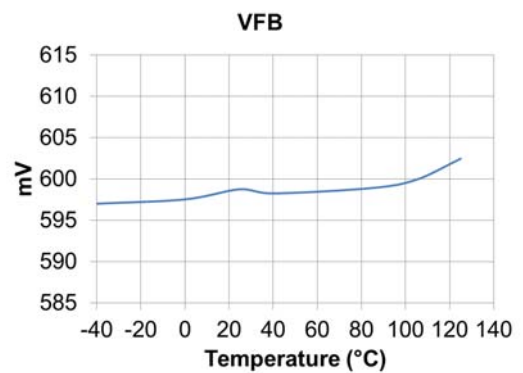
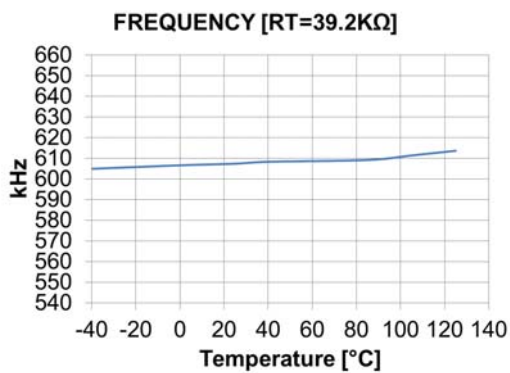
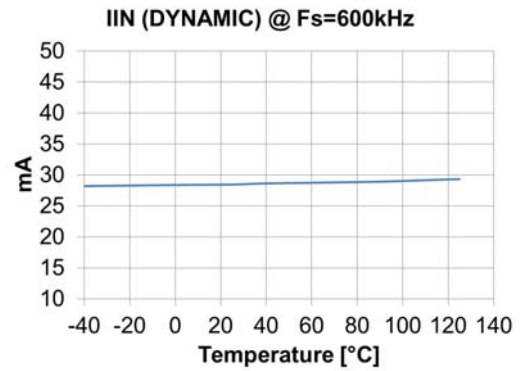
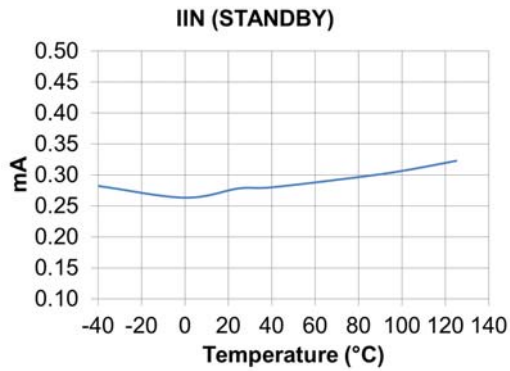
**TYPICAL OPERATING CHARACTERISTICS (-40°C to +125°C)**

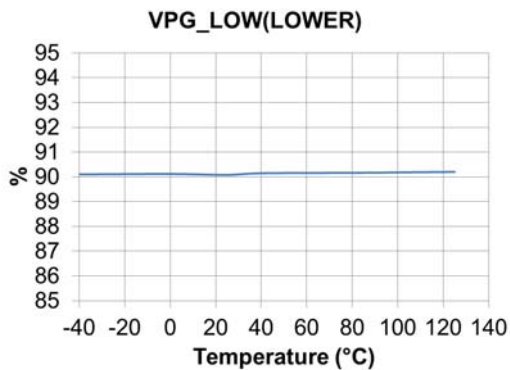
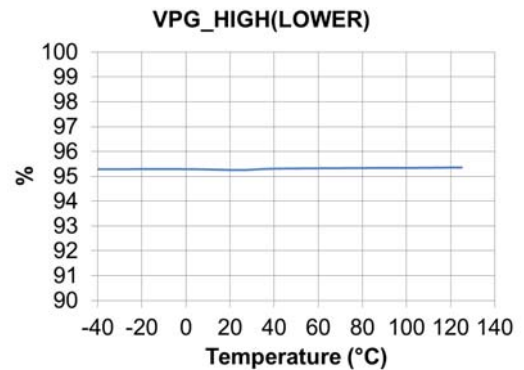
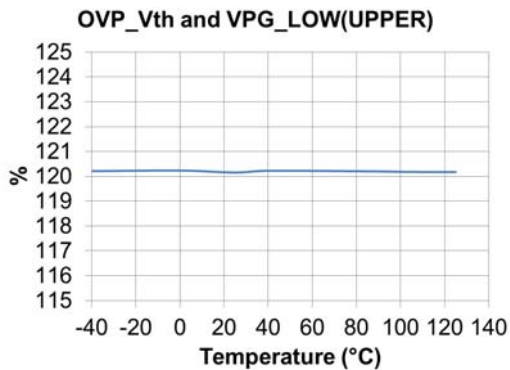
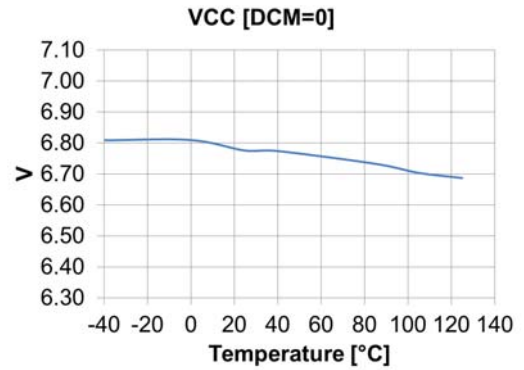
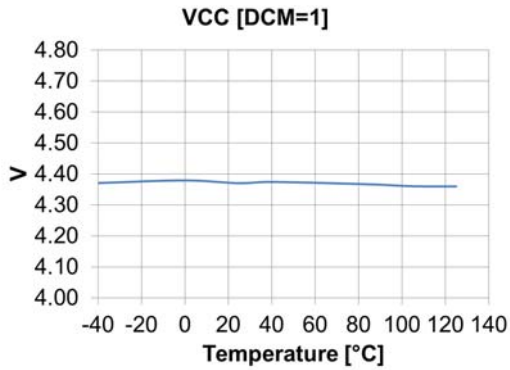
**TYPICAL OPERATING CHARACTERISTICS (-40°C TO +125°C)**

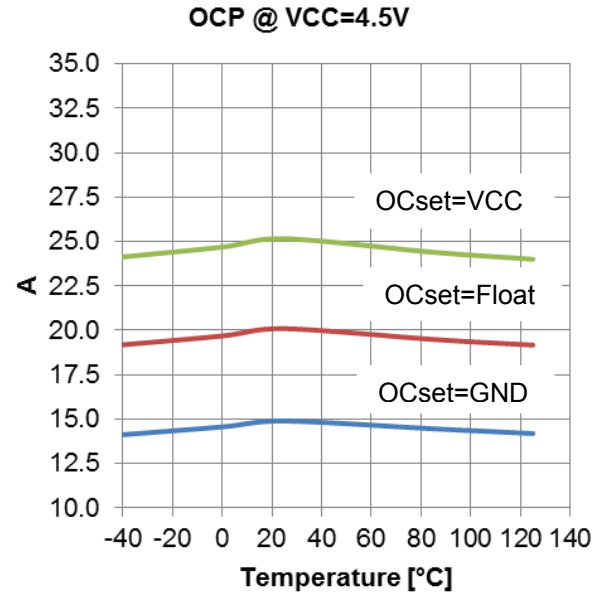
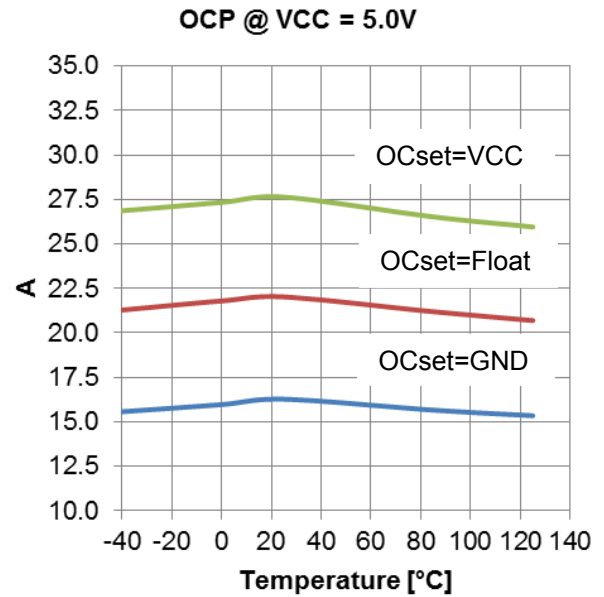
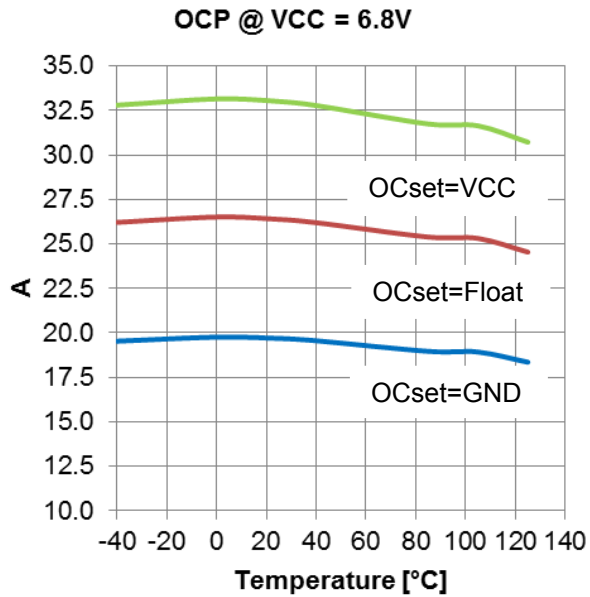
**TYPICAL OPERATING CHARACTERISTICS (-40°C TO +125°C)**

## THEORY OF OPERATION

### DESCRIPTION

The IR3447 uses a PWM voltage mode control scheme with external compensation to provide good noise immunity and maximum flexibility in selecting inductor values and capacitor types.

The switching frequency is programmable from 300kHz to 1.5MHz and provides the capability of optimizing the design in terms of size and performance.

IR3447 provides precisely regulated output voltage programmed via two external resistors from 0.6V to  $0.86 \cdot P_{Vin}$ .

The IR3447 operates with an internal bias supply (LDO) which is connected to the VCC pin. This allows operation with single supply. The bias voltage is variable according to load condition. If the output load current is less than half of the peak-to-peak inductor current, a lower bias voltage, 4.4V, is used as the internal gate drive voltage; otherwise, a higher voltage, 6.8V, is used.

This feature helps the converter to reduce power losses. The device can also be operated with an external supply from 4.5V to 7.5V, allowing an extended operating input voltage (P<sub>Vin</sub>) range from 1.5V to 21V. For using the internal LDO supply, the Vin pin should be connected to P<sub>Vin</sub> pin. If an external supply is used, it should be connected to VCC pin and the Vin pin should be shorted to VCC pin.

The device utilizes the on-resistance of the low side MOSFET (synchronous Mosfet) as current sense element. This method enhances the converter's efficiency and reduces cost by eliminating the need for external current sense resistor.

IR3447 includes two low  $R_{ds(on)}$  MOSFETs using IR's HEXFET technology. These are specifically designed for high efficiency applications.

### UNDER-VOLTAGE LOCKOUT AND POR

The under-voltage lockout circuit monitors the voltage of VCC pin and the Enable input. It assures that the MOSFET driver outputs remain in the off state whenever either of these two signals drops below the

set thresholds. Normal operation resumes once VCC and Enable rise above their thresholds.

The POR (Power On Ready) signal is generated when all these signals reach the valid logic level (see system block diagram). When the POR is asserted the soft start sequence starts (see soft start section).

### ENABLE

The Enable features another level of flexibility for startup. The Enable has precise threshold which is internally monitored by Under-Voltage Lockout (UVLO) circuit. Therefore, the IR3447 will turn on only when the voltage at the Enable pin exceeds this threshold, typically, 1.2V.

If the input to the Enable pin is derived from the bus voltage by a suitably programmed resistive divider, it can be ensured that the IR3447 does not turn on until the bus voltage reaches the desired level Figure 4. Only after the bus voltage reaches or exceeds this level and voltage at the Enable pin exceeds its threshold, IR3447 will be enabled. Therefore, in addition to being a logic input pin to enable the IR3447, the Enable feature, with its precise threshold, also allows the user to implement an Under-Voltage Lockout for the bus voltage (P<sub>Vin</sub>). It can help prevent the IR3447 from regulating at low P<sub>Vin</sub> voltages that can cause excessive input current.

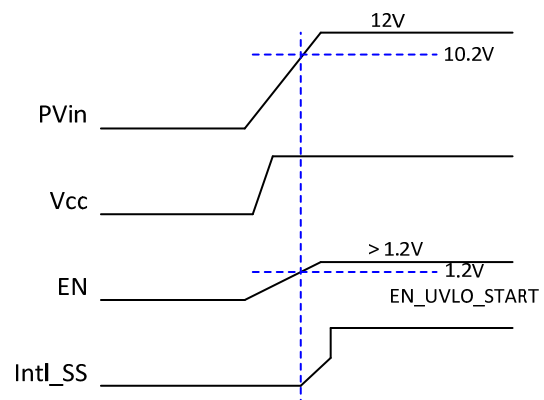

Figure 4: Normal Start up, device turns on when the bus voltage reaches 10.2V

A resistor divider is used at EN pin from P<sub>Vin</sub> to turn on the device at 10.2V.

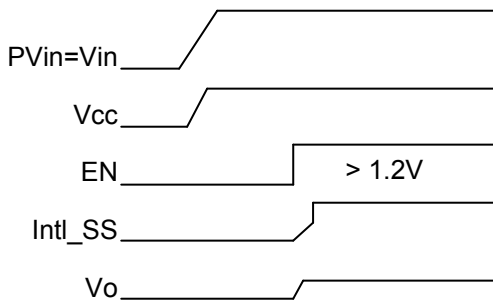

Figure 5: Recommended startup for Normal operation

Figure 5 shows the recommended startup sequence for the typical operation of IR3447 with Enable used as logic input.

### PRE-BIAS STARTUP

IR3447 is able to start up into pre-charged output, which prevents oscillation and disturbances of the output voltage.

The output starts in asynchronous fashion and keeps the synchronous MOSFET (Sync FET) off until the first gate signal for control MOSFET (Ctrl FET) is generated. Figure 6 shows a typical Pre-Bias condition at start up. The sync FET always starts with a narrow pulse width (12.5% of a switching period) and gradually increases its duty cycle with a step of 12.5% until it reaches the steady state value. The number of these startup pulses for each step is 16 and it's internally programmed. Figure 7 shows the series of 16x8 startup pulses.

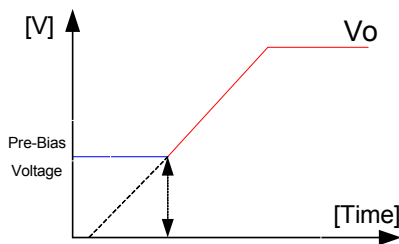

Figure 6: Pre-Bias startup

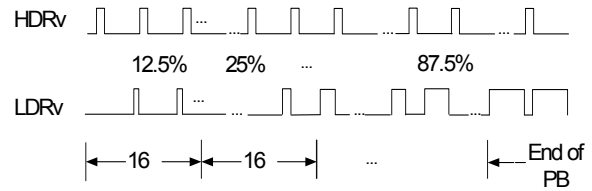

Figure 7: Pre-Bias startup pulses

### SOFT-START

IR3447 has an internal digital soft-start to control the output voltage rise and to limit the current surge at the start-up. To ensure correct start-up, the soft-start sequence initiates when the Enable and VCC rise above their UVLO thresholds and generate the Power On Ready (POR) signal. The internal soft-start (Intl\_SS) signal linearly rises with the rate of 0.4mV/μs from 0V to 1.5V. Figure 8 shows the waveforms during soft start. The normal Vout startup time is fixed, and is equal to:

$$T_{start} = \frac{(0.75V - 0.15V)}{0.4mV / \mu S} = 1.5mS \quad (1)$$

During the soft start the over-current protection (OCP) and over-voltage protection (OVP) is enabled to protect the device for any short circuit or over voltage condition.

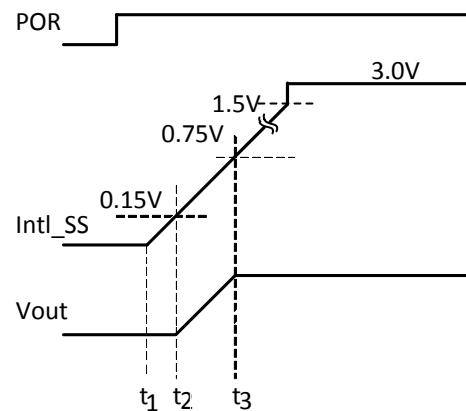

Figure 8: Theoretical operation waveforms during soft-start

### OPERATING FREQUENCY

The switching frequency can be programmed between 300kHz – 1500kHz by connecting an external resistor

from  $R_t$  pin to LGnd. Table 1 tabulates the oscillator frequency versus  $R_t$ .

Table 1: Switching Frequency( $F_s$ ) vs. External Resistor( $R_t$ )

| $R_t$ (K $\Omega$ ) | Freq (KHz) |
|---------------------|------------|
| 80.6                | 300        |
| 60.4                | 400        |
| 48.7                | 500        |
| 39.2                | 600        |
| 34                  | 700        |
| 29.4                | 800        |
| 26.1                | 900        |
| 23.2                | 1000       |
| 21                  | 1100       |
| 19.1                | 1200       |
| 17.4                | 1300       |
| 16.2                | 1400       |
| 15                  | 1500       |

## SHUTDOWN

IR3447 can be shutdown by pulling the Enable pin below its 1.0V threshold. During shutdown the high side and the low side drivers are turned off.

## OVER CURRENT PROTECTION

The Over Current (OC) protection is performed by sensing the inductor current through the  $R_{DS(on)}$  of the Synchronous MOSFET. This method enhances the converter's efficiency, reduces cost by eliminating a current sense resistor and any layout related noise issues. The Over Current (OC) limit can be set to one of three possible settings by floating the OCset pin, by pulling up the OCset pin to VCC, or pulling down the OCset pin to PGnd. The current limit scheme in the IR3447 uses an internal temperature compensated current source to achieve an almost constant OC limit over temperature.

Over Current Protection circuit senses the inductor current flowing through the Synchronous MOSFET. To help minimize false tripping due to noise and transients, inductor current is sampled for about 30 nS on the downward inductor current slope approximately 12.5% of the switching period before the inductor current valley. However, if the Synchronous MOSFET is on for less than 12.5% of the switching period, the

current is sampled approximately 40nS after the start of the downward slope of the inductor current. When the sampled current is higher than the OC Limit, an OC event is detected.

When an Over Current event is detected, the converter enters hiccup mode. Hiccup mode is performed by latching the OC signal and pulling the Intl\_SS signal to ground for 20.48 mS (typ.). OC signal clears after the completion of hiccup mode and the converter attempts to return to the nominal output voltage using a soft start sequence. The converter will repeat hiccup mode and attempt to recover until the overload or short circuit condition is removed.

Because the IR3447 uses valley current sensing, the actual DC output current limit will be greater than OC limit. The DC output current is approximately half of peak to peak inductor ripple current above selected OC limit. OC Limit, inductor value, input voltage, output voltage and switching frequency are used to calculate the DC output current limit for the converter. Equation (2) to determine the approximate DC output current limit.

$$I_{OCP} = I_{LIMIT} + \frac{\Delta i}{2} \quad (2)$$

- $I_{OCP}$  = DC current limit hiccup point
- $I_{LIMIT}$  = Current Limit Valley Point
- $\Delta i$  = Inductor ripple current

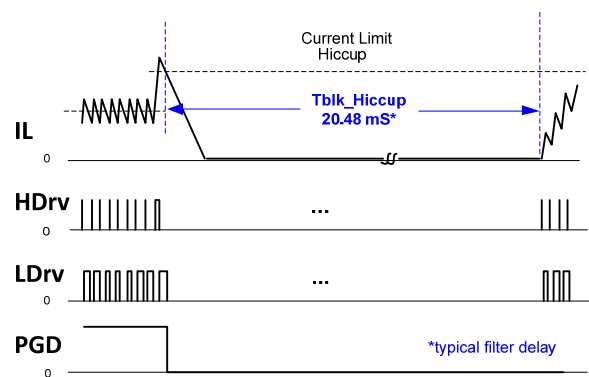

Figure 9: Timing Diagram for Current Limit Hiccup

## THERMAL SHUTDOWN

Temperature sensing is provided inside IR3447. The trip threshold is typically 145°C. When trip threshold is exceeded, thermal shutdown turns off both MOSFETs and resets the internal soft start.

Automatic restart is initiated when the sensed temperature drops within the operating range. There is a 20°C hysteresis in the thermal shutdown threshold.

### REMOTE VOLTAGE SENSING

True differential remote sensing in the feedback loop is critical to high current applications where the output voltage across the load may differ from the output voltage measured locally across an output capacitor at the output inductor, and to applications that require die voltage sensing.

The RS+ and RS- pins of the IR3447 form the inputs to a remote sense differential amplifier (RSA) with high speed, low input offset and low input bias current which ensure accurate voltage sensing and fast transient response in such applications.

The input range for the differential amplifier is limited to 1.5V below the VCC rail. Note that IR3447 incorporates a smart LDO which switches the VCC rail voltage depending on the loading. When determining the input range assume the part is in light load and using the lower VCC rail voltage.

There are two remote sense configurations that are usually implemented. Figure 10 shows a general remote sense (RS) configuration. This configuration allows the RSA to monitor output voltages above VCC. A resistor divider is placed in between the output and the RSA to provide a lower input voltage to the RSA inputs. Typically, the resistor divider is calculated to provide VREF (0.6V) across the RSA inputs which is then outputted to RSo. The input impedance of the RSA is 63 KOhms typically and should be accounted for when determining values for the resistor divider. To account for the input impedance, assume a 63 KOhm resistor in parallel to the lower resistor in the divider network. The compensation is then designed for 0.6V to match the RSo value.

Low voltage applications can use the second remote sense configuration. When the output voltage range is within the RSA input specifications, no resistor divider is needed in between the converter output and RSA. The second configuration is shown in Figure 11. The RSA is used as a unity gain buffer and compensation is determined normally.

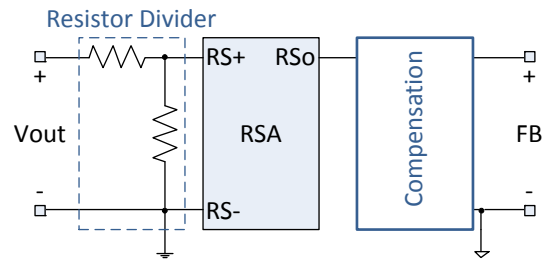

Figure 10: General Remote Sense Configuration

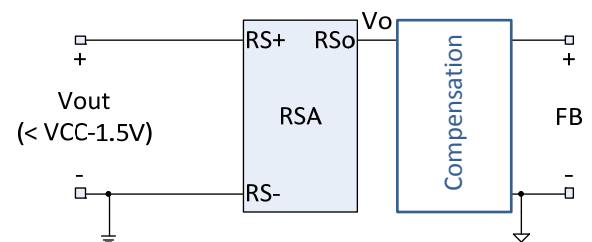

Figure 11: Remote Sense Configuration for Vout less than VCC-1.5V

### EXTERNAL SYNCHRONIZATION

IR3447 incorporates an internal phase lock loop (PLL) circuit which enables synchronization of the internal oscillator to an external clock. This function is important to avoid sub-harmonic oscillations due to beat frequency for embedded systems when multiple point-of-load (POL) regulators are used. A multi-function pin, Rt/Sync, is used to connect the external clock. If the external clock is present before the converter turns on, Rt/Sync pin can be connected to the external clock signal solely and no other resistor is needed. If the external clock is applied after the converter turns on, or the converter switching frequency needs to toggle between the external clock frequency and the internal free-running frequency, an external resistor from Rt/Sync pin to LGnd is required to set the free-running frequency.

When an external clock is applied to Rt/Sync pin after the converter runs in steady state with its free-running frequency, a transition from the free-running frequency to the external clock frequency will happen. This transition is to gradually make the actual switching frequency equal to the external clock frequency, no matter which one is higher. When the external clock signal is removed from Rt/Sync pin, the switching frequency is also changed to free-running gradually. In order to minimize the impact from these

transitions to output voltage, a diode is recommended to add between the external clock and Rt/Sync pin. Figure 12 shows the timing diagram of these transitions.

An internal circuit is used to change the PWM ramp slope according to the clock frequency applied on Rt/Sync pin. Even though the frequency of the external synchronization clock can vary in a wide range, the PLL circuit keeps the ramp amplitude constant, requiring no adjustment of the loop compensation. P<sub>Vin</sub> variation also affects the ramp amplitude, which will be discussed separately in Feed-Forward section.

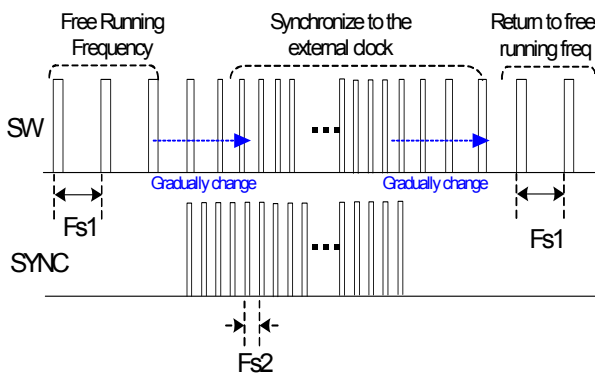

Figure 12: Timing Diagram for Synchronization to the external clock ( $F_{s1} > F_{s2}$  or  $F_{s1} < F_{s2}$ )

### FEED-FORWARD

Feed-Forward (F.F.) is an important feature, because it can keep the converter stable and preserve its load transient performance when P<sub>Vin</sub> varies. The PWM ramp amplitude (V<sub>ramp</sub>) is proportionally changed with P<sub>Vin</sub> to maintain P<sub>Vin</sub>/V<sub>ramp</sub> almost constant throughout P<sub>Vin</sub> variation range (as shown in Figure 13). The PWM ramp amplitude is adjusted to 0.15 of P<sub>Vin</sub>. Thus, the control loop bandwidth and phase margin can be maintained constant. Feed-forward function can also minimize impact on output voltage from fast P<sub>Vin</sub> change. F.F. is disabled when P<sub>Vin</sub> < 6.2V and the PWM ramp is typically 0.9V. For P<sub>Vin</sub> < 6.2V, P<sub>Vin</sub> voltage should be accounted for when calculating control loop parameters.

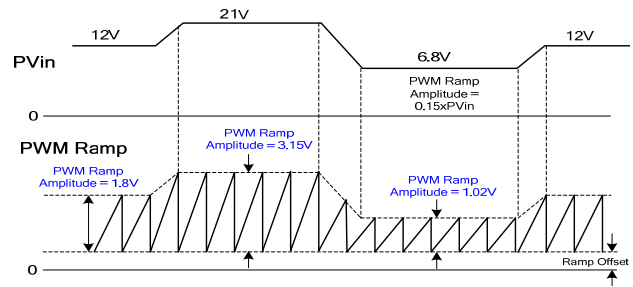

Figure 13: Timing Diagram for Feed-Forward (F.F.) Function

### SMART LOW DROPOUT REGULATOR (LDO)

IR3447 has an integrated low dropout (LDO) regulator which can provide gate drive voltage for both drivers. In order to improve overall efficiency over the whole load range, LDO voltage is set to 6.8V (typ.) at mid- or heavy load condition to reduce R<sub>ds(on)</sub> and thus MOSFET conduction loss; and it is reduced to 4.4V (typ.) at light load condition to reduce gate drive loss.

The smart LDO selects its output voltage according to the load condition by sensing the inductor current (I<sub>L</sub>). At light load condition, the inductor current can fall below zero as shown in Figure 14. A zero crossing comparator is used to detect when the inductor current falls below zero at the LD<sub>rv</sub> Falling Edge. If the comparator detects zero crossing events for 256 consecutive switching cycles, the smart LDO reduces its output to 4.4V. The LDO voltage will remain low until a zero crossing is not detected. Once a zero crossing is not detected, the counter is reset and LDO voltage returns to 6.8V. Figure 14 shows the timing diagram. Whenever the device turns on, LDO always starts with 6.8V, then goes to 4.4V / 6.8V depending upon the load condition. However, if only V<sub>in</sub> is applied with Enable low, the LDO output is 4.4V.

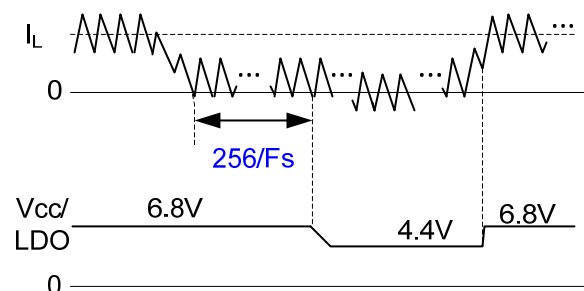

Figure 14: Time Diagram for Smart LDO

Users can configure the IR3447 to use a single supply or dual supplies. Depending on the configuration used the PVin, Vin and VCC pins are connected differently. Below several configurations are shown. In an internally biased configuration, the LDO draws from the Vin pin and provides a gate drive voltage, as shown in Figure 15. By connecting Vin and PVin together as shown in the Figure 16, IR3447 is an internally biased single supply configuration that runs off a single supply.

IR3447 can also use an external bias to provide gate drive voltage for the drivers instead of the internal LDO. To use an external bias, connected Vin and VCC to the external bias. PVin can use a separate rail as shown in Figure 17 or run off the same rail as Vin and VCC.

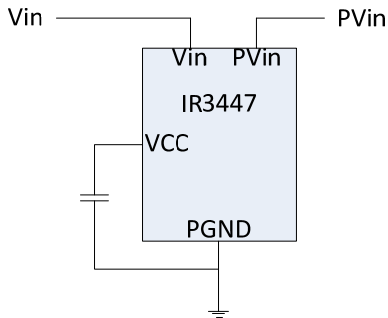

Figure 15: Internally Biased Configuration

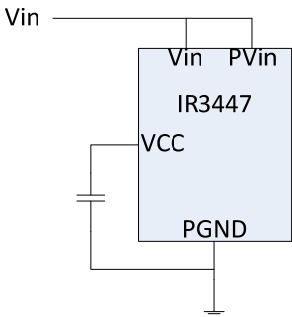

Figure 16: Internally Biased Single Supply Configuration

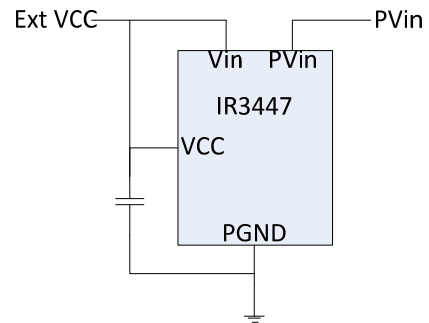

Figure 17: Externally Biased Configuration

When the Vin voltage is below 6.8V, the internal LDO enters the dropout mode at medium and heavy load. The dropout voltage increases with the switching frequency. Figure 18 shows the LDO voltage for 600kHz and 1000kHz switching frequency.

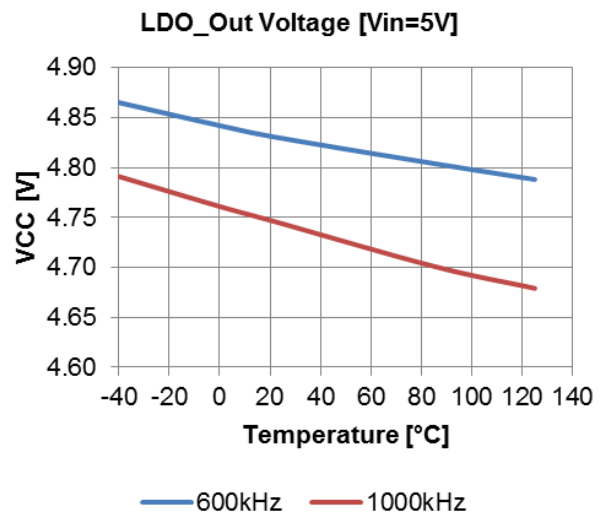

Figure 18: LDO\_Out Voltage in dropout mode

### CBYP

This pin reflects the internal reference voltage which is used by the error amplifier to set the output voltage. In most operating conditions this pin is only connected to an external bypass capacitor and it is left floating. A minimum 100pF ceramic capacitor is required from stability point of view

### POWER GOOD OUTPUT

IR3447 continually monitors the output voltage via the sense pin (Vsns) voltage. The Vsns voltage is an input to the window comparator with upper and lower threshold of OVP(trip) and VPG\_high(lower)

respectively. PGood signal is high whenever Vsns voltage is within the PGood comparator window thresholds. Hysteresis has been applied to the lower threshold, PGood signal goes low when Vsns drops below VPG\_low(lower) instead of VPG\_high(lower). The PGood pin is open drain and it needs to be externally pulled high. High state indicates that output is in regulation. Figure 19 show the timing diagram of the PGood signal. Vsns signal is also used by OVP comparator for detecting output over voltage condition. PGood signal is low when Enable is low.

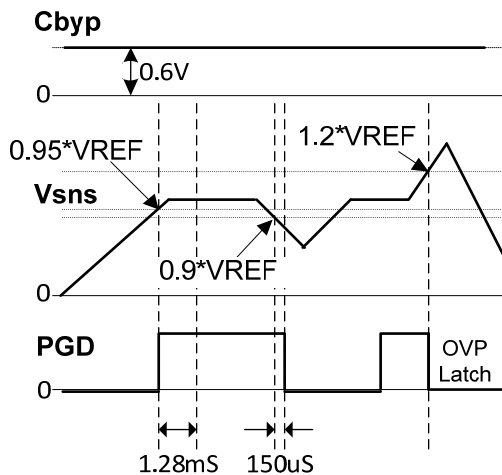

Figure 19: PGood Timing Diagram

### OVER-VOLTAGE PROTECTION (OVP)

Over-voltage protection in IR3447 is achieved by comparing sense pin voltage Vsns to a pre-set threshold. When Vsns exceeds the over voltage threshold, an over voltage trip signal asserts after 2.5 uS (typ.) delay. The high side drive signal HDrv is latched off immediately and PGood flags are set low. The low side drive signal is kept on until the Vsns voltage drops below the threshold. HDrv remains latched off until a reset is performed by cycling VCC. OVP is active when enable is high or low.

Vsns voltage is set by the voltage divider connected to the output and it can be programmed externally. Figure 20 shows the timing diagram for OVP.

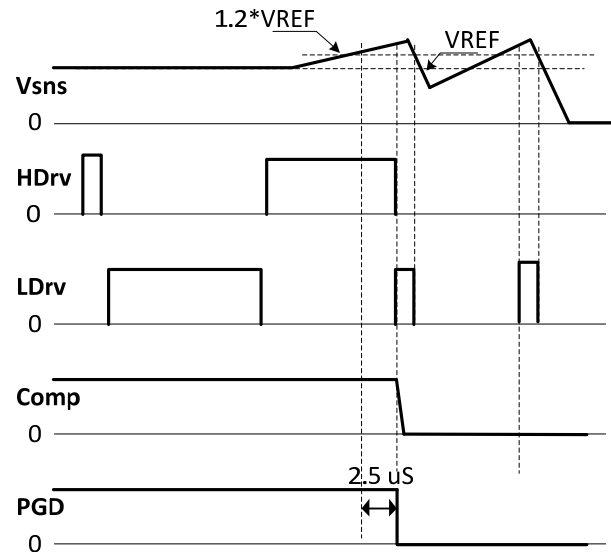

Figure 20: Timing Diagram for OVP in non-tracking mode

### BODY BRAKING™

The Body Braking feature of the IR3447 allows improved transient response for step-down load transients. A severe step-down load transient would cause an overshoot in the output voltage and drive the Comp pin voltage down until control saturation occurs demanding 0% duty cycle and the PWM input to the Control FET driver is kept OFF. When the first such skipped pulse occurs, the IR3447 enters Body Braking mode, wherein the Sync FET also turned OFF. The inductor current then decays by freewheeling through the body diode of the Sync FET. Thus, with Body Braking, the forward voltage drop of the body diode provides an additional voltage to discharge the inductor current faster to the light load value as shown in equation (3) and equation (4) below:

$$\frac{di_L}{dt} = -\frac{V_o + V_D}{L}, \text{ with body braking} \quad (3)$$

$$\frac{di_L}{dt} = -\frac{V_o}{L}, \text{ without body braking} \quad (4)$$

- $I_L$  = Inductor current
- $V_D$  = Forward voltage drop of the body diode of the Sync FET.
- $V_o$  = output voltage
- $L$  = Inductor value

The Body Braking mechanism is kept OFF during pre-bias operation. Also, in the event of an extremely severe load step-down transient causing OVP, the

Body Brake is overridden by the OVP latch, which turns on the Sync FET.

$$\therefore PV_{in} \times F_s \leq \frac{0.6V}{50nS} = 12V / \mu S$$

### MINIMUM ON TIME CONSIDERATIONS

The minimum ON time is the shortest amount of time for Ctrl FET to be reliably turned on. This is very critical parameter for low duty cycle, high frequency applications. Conventional approach limits the pulse width to prevent noise, jitter and pulse skipping. This results to lower closed loop bandwidth.

IR has developed a proprietary scheme to improve and enhance minimum pulse width which utilizes the benefits of voltage mode control scheme with higher switching frequency, wider conversion ratio and higher closed loop bandwidth, the latter results in reduction of output capacitors. Any design or application using IR3447 must ensure operation with a pulse width that is higher than the minimum on-time. This is necessary for the circuit to operate without jitter and pulse-skipping, which can cause high inductor current ripple and high output voltage ripple.

$$t_{on} = \frac{D}{F_s} = \frac{V_{out}}{PV_{in} \times F_s} \quad (5)$$

In any application that uses IR3447, the following condition must be satisfied:

$$t_{on(min)} \leq t_{on} \quad (6)$$

$$t_{on(min)} \leq \frac{V_{out}}{PV_{in} \times F_s} \quad (7)$$

$$\therefore PV_{in} \times F_s \leq \frac{V_{out}}{t_{on(min)}} \quad (8)$$

The minimum output voltage is limited by the reference voltage and hence  $V_{out(min)} = 0.6V$ . Therefore, for  $V_{out(min)} = 0.6V$ ,

$$\therefore PV_{in} \times F_s \leq \frac{V_{out}}{t_{on(min)}} \quad (9)$$

Therefore, at the maximum recommended input voltage 21V and minimum output voltage, the converter should be designed at a switching frequency that does not exceed 571 kHz. Conversely, for operation at the maximum recommended operating frequency (1.5 MHz) and minimum output voltage (0.6V). The input voltage (PVin) should not exceed 8V, otherwise pulse skipping may happen.

### MAXIMUM DUTY RATIO

A certain off-time is specified for IR3447. This provides an upper limit on the operating duty ratio at any given switching frequency. The off-time remains at a relatively fixed ratio to switching period in low and mid frequency range, while in high frequency range this ratio increases, thus the lower the maximum duty ratio at which IR3447 can operate. Figure 21 shows a plot of the maximum duty ratio vs. the switching frequency with built in input voltage feed forward mechanism.

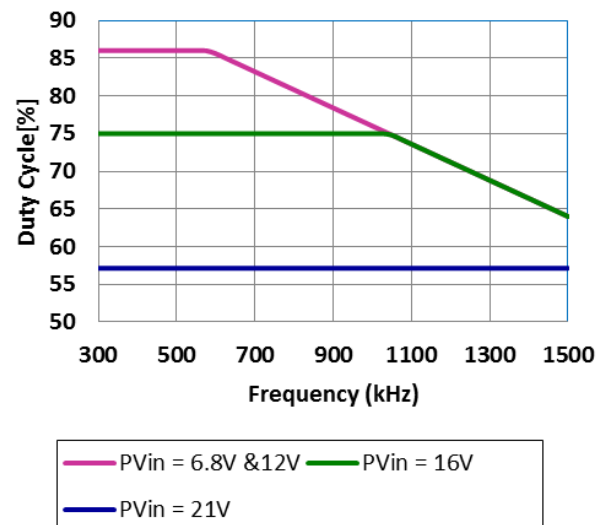

Figure 21: Maximum duty cycle vs. switching frequency

## TYPICAL OPERATING WAVEFORM

### DESIGN EXAMPLE

The following example is a typical application for IR3447. The application circuit is shown in Figure 28.

$$V_{in} = PV_{in} = 12V$$

$$F_s = 600kHz$$

$$V_o = 1.2V$$

$$I_o = 25A$$

$$\text{Ripple Voltage} = \pm 1\% * V_o$$

$$\Delta V_o = \pm 4\% * V_o \text{ (for 30\% load transient)}$$

### Enabling the IR3447

As explained earlier, the precise threshold of the Enable lends itself well to implementation of a UVLO for the Bus Voltage as shown in Figure 22.

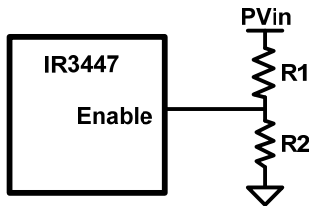

Figure 22: Using Enable pin for UVLO implementation

For a typical Enable threshold of  $V_{EN} = 1.2V$

$$PV_{in(min)} \times \frac{R_2}{R_1 + R_2} = V_{EN} = 1.2 \quad (10)$$

$$R_2 = R_1 \frac{V_{EN}}{PV_{in(min)} - V_{EN}} \quad (11)$$

For  $PV_{in(min)} = 9.2V$ ,  $R_1 = 49.9K$  and  $R_2 = 7.5K$  ohm is a good choice.

### Programming the frequency

For  $F_s = 600$  kHz, select  $R_t = 39.2$  K $\Omega$ , using Table 1.

### Output Voltage Programming

Output voltage is programmed by reference voltage and external voltage divider. The FB pin is the inverting input of the error amplifier, which is internally referenced to VREF. The divider ratio is set to equal VREF at the FB pin when the output is at its desired value. When an external resistor divider is connected to the output as shown in Figure 23, the output voltage is defined by using the following equation:

$$V_o = V_{ref} \times \left( 1 + \frac{R_5}{R_6} \right) \quad (12)$$

$$R_6 = R_5 \times \left( \frac{V_{ref}}{V_o - V_{ref}} \right) \quad (13)$$

For the calculated values of R5 and R6, see feedback compensation section.

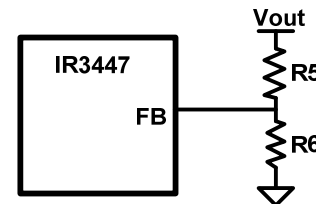

Figure 23: Typical application of the IR3447 for programming the output voltage

### Bootstrap Capacitor Selection

To drive the Control FET, it is necessary to supply a gate voltage at least 4V greater than the voltage at the SW pin, which is connected to the source of the Control FET. This is achieved by using a bootstrap configuration, which comprises the internal bootstrap diode and an external bootstrap capacitor (C1). The operation of the circuit is as follows: When the sync FET is turned on, the capacitor node connected to SW is pulled down to ground. The capacitor charges towards  $V_{cc}$  through the internal bootstrap diode (Figure 24), which has a forward voltage drop  $V_D$ . The voltage  $V_c$  across the bootstrap capacitor C1 is approximately given as:

$$V_c \cong V_{cc} - V_D \quad (14)$$

When the control FET turns on in the next cycle, the capacitor node connected to SW rises to the bus voltage  $V_{in}$ . However, if the value of C1 is appropriately chosen, the voltage  $V_c$  across C1 remains approximately unchanged and the voltage at the Boot pin becomes:

$$V_{Boot} \cong V_{in} + V_{cc} - V_D \quad (15)$$

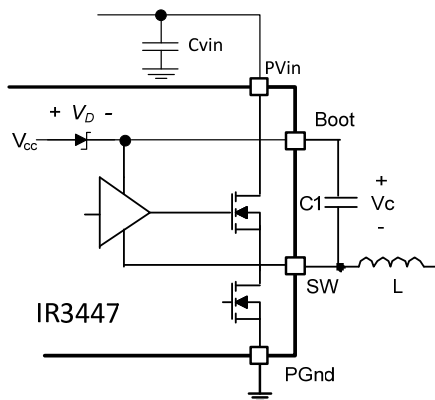

Figure 24: Bootstrap circuit to generate  $V_c$  voltage

A bootstrap capacitor of value 0.1 $\mu$ F is suitable for most applications.

### Input Capacitor Selection

The ripple currents generated during the on time of the control FETs should be provided by the input capacitor. The RMS value of this ripple for each channel is expressed by:

$$I_{RMS} = I_o \times \sqrt{D \times (1 - D)} \quad (16)$$

$$D = \frac{V_o}{V_{in}} \quad (17)$$

Where:

$D$  is the Duty Cycle

$I_{RMS}$  is the RMS value of the input capacitor current.

$I_o$  is the output current.

$I_o=25A$  and  $D = 0.1$ , the  $I_{RMS} = 7.5A$ .

Ceramic capacitors are recommended due to their peak current capabilities. They also feature low ESR and ESL at higher frequency which enables better efficiency. For this application, it is advisable to have 7x22 $\mu$ F, 25V ceramic capacitors, GRM31CR61E226KE15L from Murata. In addition to these, although not mandatory, a 1x330 $\mu$ F, 25V SMD capacitor EEV-FK1E331P from Panasonic may also be used as a bulk capacitor and is recommended if the input power supply is not located close to the converter.

### Inductor Selection

Inductors are selected based on output power, operating frequency and efficiency requirements. A low inductor value causes large ripple current, resulting in the smaller size, faster response to a load transient but may also result in reduced efficiency and high output noise. Generally, the selection of the inductor value can be reduced to the desired maximum ripple current in the inductor ( $\Delta i$ ). The optimum point is usually found between 20% and 50% ripple of the output current. For the buck converter, the inductor value for the desired operating ripple current can be determined using the following relation:

$$V_{in} - V_o = L \times \frac{\Delta i}{\Delta t}; \Delta t = D \times \frac{1}{F_s}$$

$$L = (V_{in} - V_o) \times \frac{V_o}{V_{in} \times \Delta i \times F_s} \quad (18)$$

Where:

$V_{in}$  = Maximum input voltage

$V_o$  = Output Voltage

$\Delta i$  = Inductor Ripple Current

$F_s$  = Switching Frequency

$\Delta t$  = On time for Control FET

$D$  = Duty Cycle

If  $\Delta i \approx 30\% \times I_o$ , then the inductor is calculated to be 0.24 $\mu$ H. Select  $L=0.215\mu$ H, PCDC1008-R215EMO, from Cynotec which provides an inductor suitable for this application.

### Output Capacitor Selection

The voltage ripple and transient requirements determine the output capacitors type and values. The criterion is normally based on the value of the Effective Series Resistance (ESR). However the actual capacitance value and the Equivalent Series Inductance (ESL) are other contributing components. These components can be described as:

$$\begin{aligned} \Delta V_o &= \Delta V_{o(ESR)} + \Delta V_{o(ESL)} + \Delta V_{o(C)} \\ \Delta V_{o(ESR)} &= \Delta I_L \times ESR \\ \Delta V_{o(ESL)} &= \left( \frac{V_{in} - V_o}{L} \right) \times ESL \\ \Delta V_{o(C)} &= \frac{\Delta I_L}{8 \times C_o \times F_s} \end{aligned} \quad (19)$$

Where:

$\Delta V_o$  = Output Voltage Ripple  
 $\Delta I_L$  = Inductor Ripple Current

Since the output capacitor has a major role in the overall performance of the converter and determines the result of transient response, selection of the capacitor is critical. The IR3447 can perform well with all types of capacitors.

As a rule, the capacitor must have low enough ESR to meet output ripple and load transient requirements.

The goal for this design is to meet the voltage ripple requirement in the smallest possible capacitor size. Therefore it is advisable to select ceramic capacitors due to their low ESR and ESL and small size. Ten of TDK C2012X5R0J476M (47uF/0805/X5R/6.3V) capacitors is a good choice.

It is also recommended to use a 0.1µF ceramic capacitor at the output for high frequency filtering.

### Feedback Compensation

The IR3447 is a voltage mode controller. The control loop is a single voltage feedback path including error amplifier and error comparator. To achieve fast transient response and accurate output regulation, a compensation circuit is necessary. The goal of the compensation network is to provide a closed-loop

transfer function with the highest 0 dB crossing frequency and adequate phase margin (greater than 45°).

The output LC filter introduces a double pole, -40dB/decade gain slope above its corner resonant frequency, and a total phase lag of 180°. The resonant frequency of the LC filter is expressed as follows:

$$F_{LC} = \frac{1}{2 \times \pi \times \sqrt{L_o \times C_o}} \quad (20)$$

Figure 25 shows gain and phase of the LC filter. Since we already have 180° phase shift from the output filter alone, the system runs the risk of being unstable.

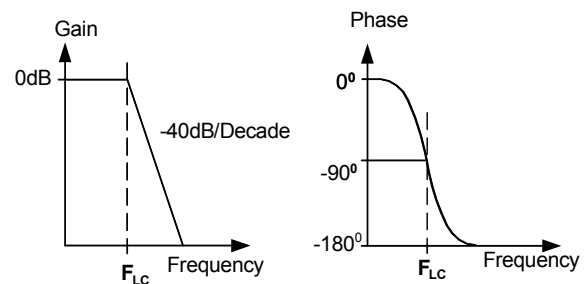

Figure 25: Gain and Phase of LC filter

The IR3447 uses a voltage-type error amplifier with high-gain and high-bandwidth. The output of the amplifier is available for DC gain control and AC phase compensation.

The error amplifier can be compensated either in type II or type III compensation. Local feedback with Type II compensation is shown in Figure 26.

This method requires that the output capacitor have enough ESR to satisfy stability requirements. If the output capacitor's ESR generates a zero at 5kHz to 50kHz, the zero generates acceptable phase margin and the Type II compensator can be used.

The ESR zero of the output capacitor is expressed as follows:

$$F_{ESR} = \frac{1}{2 \times \pi \times ESR \times C_o} \quad (21)$$

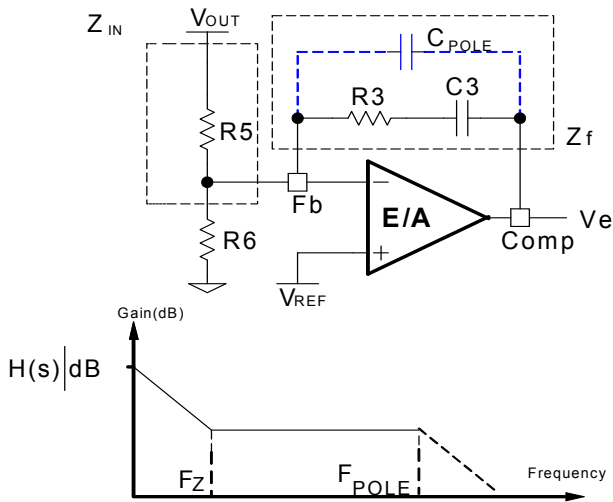

Figure 26: Type II compensation network and its asymptotic gain plot

The transfer function ( $V_e/V_{out}$ ) is given by:

$$\frac{V_e}{V_{out}} = H(s) = -\frac{Z_f}{Z_{IN}} = -\frac{1 + sR_3C_3}{sR_5C_3} \quad (22)$$

The (s) indicates that the transfer function varies as a function of frequency. This configuration introduces a gain and zero, expressed by:

$$|H(s)| = \frac{R_3}{R_5} \quad (23)$$

$$F_z = \frac{1}{2 \times \pi \times R_3 \times C_3} \quad (24)$$

First select the desired zero-crossover frequency ( $F_o$ ):

$$F_o > F_{ESR} \text{ and } F_o \leq (1/5 \sim 1/10) \times F_s \quad (25)$$

Use the following equation to calculate R3:

$$R_3 = \frac{V_{ramp} \times F_o \times F_{ESR} \times R_5}{V_{in} \times \beta \times F_{LC}^2} \quad (26)$$

Where:

$V_{in}$  = Maximum Input Voltage

$V_{osc}$  = Amplitude of the oscillator Ramp Voltage

$F_o$  = Crossover Frequency

$F_{ESR}$  = Zero Frequency of the Output Capacitor

$F_{LC}$  = Resonant Frequency of the Output Filter

$\beta = (R_{S+} - R_{S-}) / V_o$

$R_5$  = Feedback Resistor

To cancel one of the LC filter poles, place the zero before the LC filter resonant frequency pole:

$$F_z = 75\% \times F_{LC}$$

$$F_z = 0.75 \times \frac{1}{2 \times \pi \sqrt{L_o \times C_o}} \quad (27)$$

Use equation (24), (25) and (26) to calculate C3.

One more capacitor is sometimes added in parallel with C3 and R3. This introduces one more pole which is mainly used to suppress the switching noise.

The additional pole is given by:

$$F_p = \frac{1}{2 \times \pi \times \frac{C_3 \times C_{POLE}}{C_3 + C_{POLE}}} \quad (28)$$

The pole sets to one half of the switching frequency which results in the capacitor  $C_{POLE}$ :

$$C_{POLE} = \frac{1}{\pi \times R_3 \times F_s - \frac{1}{C_3}} \cong \frac{1}{\pi \times R_3 \times F_s} \quad (29)$$

For a general unconditional stable solution for any type of output capacitors with a wide range of ESR values, we use a local feedback with a type III compensation network. The typically used compensation network for voltage-mode controller is shown in Figure 27.

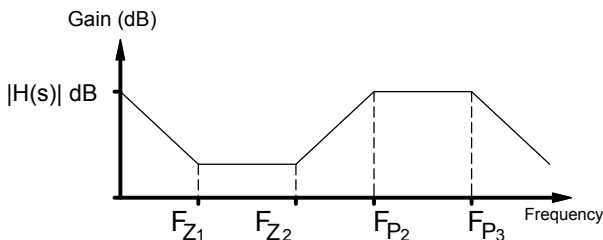
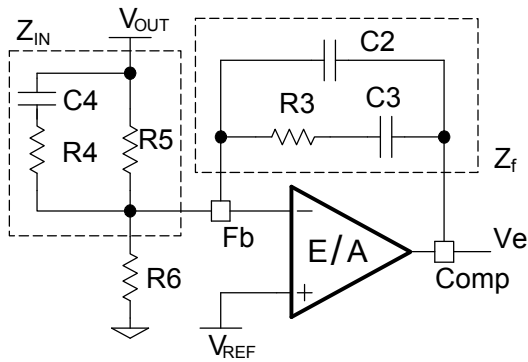

Figure 27: Type III Compensation network and its asymptotic gain plot

Again, the transfer function is given by:

$$\frac{V_e}{V_{out}} = H(s) = -\frac{Z_f}{Z_{IN}}$$

By replacing  $Z_{in}$  and  $Z_f$ , according to Figure 27, the transfer function can be expressed as:

$$H(s) = -\frac{(1 + sR_3C_3)[1 + sC_4(R_4 + R_5)]}{sR_5(C_2 + C_3)\left[1 + sR_3\left(\frac{C_2 \times C_3}{C_2 + C_3}\right)\right](1 + sR_4C_4)} \quad (30)$$

The compensation network has three poles and two zeros and they are expressed as follows:

$$F_{P1} = 0 \quad (31)$$

$$F_{P2} = \frac{1}{2\pi \times R_4 \times C_4} \quad (32)$$

$$F_{P3} = \frac{1}{2\pi \times R_3 \left(\frac{C_2 \times C_3}{C_2 + C_3}\right)} \cong \frac{1}{2\pi \times R_3 \times C_2} \quad (33)$$

$$F_{Z1} = \frac{1}{2\pi \times R_3 \times C_3} \quad (34)$$

$$F_{Z2} = \frac{1}{2\pi \times C_4 \times (R_3 \times R_5)} \cong \frac{1}{2\pi \times C_4 \times R_5} \quad (35)$$

Cross over frequency is expressed as:

$$F_o = R_3 \times C_4 \times \beta \times \frac{V_{in}}{V_{ramp}} \times \frac{1}{2\pi \times L_o \times C_o} \quad (36)$$

Based on the frequency of the zero generated by the output capacitor and its ESR, relative to the crossover frequency, the compensation type can be different. Table 2 shows the compensation types for relative locations of the crossover frequency.

Table 2: Different types of compensators

| Compensator Type | $F_{ESR}$ vs $F_o$               | Typical Output Capacitor |
|------------------|----------------------------------|--------------------------|
| Type II          | $F_{LC} < F_{ESR} < F_o < F_s/2$ | Electrolytic             |
| Type III         | $F_{LC} < F_o < F_{ESR}$         | SP Cap, Ceramic          |

The higher the crossover frequency is, the potentially faster the load transient response will be. However, the crossover frequency should be low enough to allow attenuation of switching noise. Typically, the control loop bandwidth or crossover frequency ( $F_o$ ) is selected such that:

$$F_o \leq (1/5 \sim 1/10) * F_s$$

The DC gain should be large enough to provide high DC-regulation accuracy. The phase margin should be greater than  $45^\circ$  for overall stability.

The specifications for designing channel 1:

$$V_{in} = 12V$$

$$V_o = 1.2V$$

$$V_{ramp} = 1.8V \text{ (This is a function of } V_{in}, \text{ pls. see Feed-Forward section)}$$

$$V_{ref} = 0.6V$$

$$\beta = (RS+ - RS-) / V_o \text{ (This assumes the resistor divider placed between } V_{out} \text{ and the RSA scales down the output voltage to } V_{ref}. \text{ If the RSA is not used or } V_{out} \text{ is connected directly}$$

to the RSA,  $\beta = 1$ . Please refer to the Remote Sensing Amplifier section)

$$L_o = 0.215 \mu\text{H}$$

$$C_o = 10 \times 47\mu\text{F}, \text{ ESR} \approx 3\text{m}\Omega \text{ each}$$

It must be noted here that the value of the capacitance used in the compensator design must be the small signal value. For instance, the small signal capacitance of the 47 $\mu\text{F}$  capacitor used in this design is 25.7 $\mu\text{F}$  at 1.2 V DC bias and 600 kHz frequency. It is this value that must be used for all computations related to the compensation. The small signal value may be obtained from the manufacturer's datasheets, design tools or SPICE models. Alternatively, they may also be inferred from measuring the power stage transfer function of the converter and measuring the double pole frequency  $F_{LC}$  and using equation (20) to compute the small signal  $C_o$ .

These result to:

$$F_{LC} = 21.4 \text{ kHz}$$

$$F_{ESR} = 2.06 \text{ MHz}$$

$$F_s/2 = 300 \text{ kHz}$$

Select crossover frequency  $F_o = 100 \text{ kHz}$

Since  $F_{LC} < F_o < F_s/2 < F_{ESR}$ , Type III is selected to place the pole and zeros.

Detailed calculation of compensation Type III:

Desired Phase Margin  $\Theta = 70^\circ$

$$F_{Z2} = F_o \sqrt{\frac{1 - \sin \Theta}{1 + \sin \Theta}} = 17.6 \text{ kHz}$$

$$F_{P2} = F_o \sqrt{\frac{1 + \sin \Theta}{1 - \sin \Theta}} = 567.1 \text{ kHz}$$

Select:

$$F_{Z1} = 0.5 \times F_{Z2} = 8.8 \text{ kHz and}$$

$$F_{P3} = 0.5 \times F_s = 300 \text{ kHz}$$

Select  $C_4 = 2.2\text{nF}$ .

Calculate  $R_3$ ,  $C_3$  and  $C_2$ :

$$R_3 = \frac{2 \times \pi \times F_o \times L_o \times C_o \times V_{osc}}{C_4 \times V_{in} \times \beta}; R_3 = 2.37 \text{ k}\Omega,$$

Select:  $R_3 = 1.91 \text{ k}\Omega$

$$C_3 = \frac{1}{2 \times \pi \times F_{Z1} \times R_3}; C_3 = 7.5 \text{ nF},$$

Select:  $C_3 = 8.2 \text{ nF}$

$$C_2 = \frac{1}{2 \times \pi \times F_{P3} \times R_3}; C_2 = 221 \text{ pF},$$

Select:  $C_2 = 160 \text{ pF}$

Calculate  $R_4$ ,  $R_5$  and  $R_6$ :

$$R_4 = \frac{1}{2 \times \pi \times C_4 \times F_{P2}}; R_4 = 127.6 \Omega,$$

Select  $R_4 = 127 \Omega$

$$R_5 = \frac{1}{2 \times \pi \times C_4 \times F_{Z2}}; R_5 = 4.11 \text{ k}\Omega,$$

Select  $R_5 = 4.22 \text{ k}\Omega$

$$R_6 = \frac{V_{ref}}{V_o - V_{ref}} \times R_5; R_6 = 4.11 \text{ k}\Omega,$$

Select  $R_6 = 4.22 \text{ k}\Omega$

If  $(\beta \times V_o)$  equals  $V_{ref}$ ,  $R_6$  is not used.

### Setting the Power Good Threshold

In this design IR3447, the PGood outer limits are set at 95% and 120% of  $V_{REF}$ . PGood signal is asserted 1.3ms after  $V_{sns}$  voltage reaches  $0.95 \times 0.6\text{V} = 0.57\text{V}$  (Figure 28). As long as the  $V_{sns}$  voltage is between the threshold ranges, Enable is high, and no fault happens, the PGood remains high.

The following formula can be used to set the PGood threshold.  $V_{out(PGood\_TH)}$  can be taken as 95% of  $V_{out}$ . Choose  $R_{sns1} = 4.22 \text{ k}\Omega$ .

$$R_{sns2} = \left( \frac{V_{out(PGood\_TH)}}{0.95 \times VREF} - 1 \right) \times R_{sns1} \quad (37)$$

$R_{sns2} = 4.22 \text{ k}\Omega$ , Select  $4.22 \text{ k}\Omega$ .

OVP comparator also uses  $V_{sns}$  signal for Over-Voltage detection. With above values for  $R_{sns2}$  and  $R_{sns1}$ , OVP trip point ( $V_{out\_OVP}$ ) is

$$V_{out\_OVP} = VREF \times 1.2 \times \frac{(R_{sns1} + R_{sns2})}{R_{sns1}} \quad (38)$$

$$V_{out\_OVP} = 1.44 \text{ V}$$

#### Selecting Power Good Pull-Up Resistor

The PGood is an open drain output and require pull up resistors to VCC. The value of the pull-up resistors should limit the current flowing into the PGood pin to less than 5mA. A typical value used is  $10\text{k}\Omega$ .

## TYPICAL APPLICATION INTERNALLY BIASED SINGLE SUPPLY

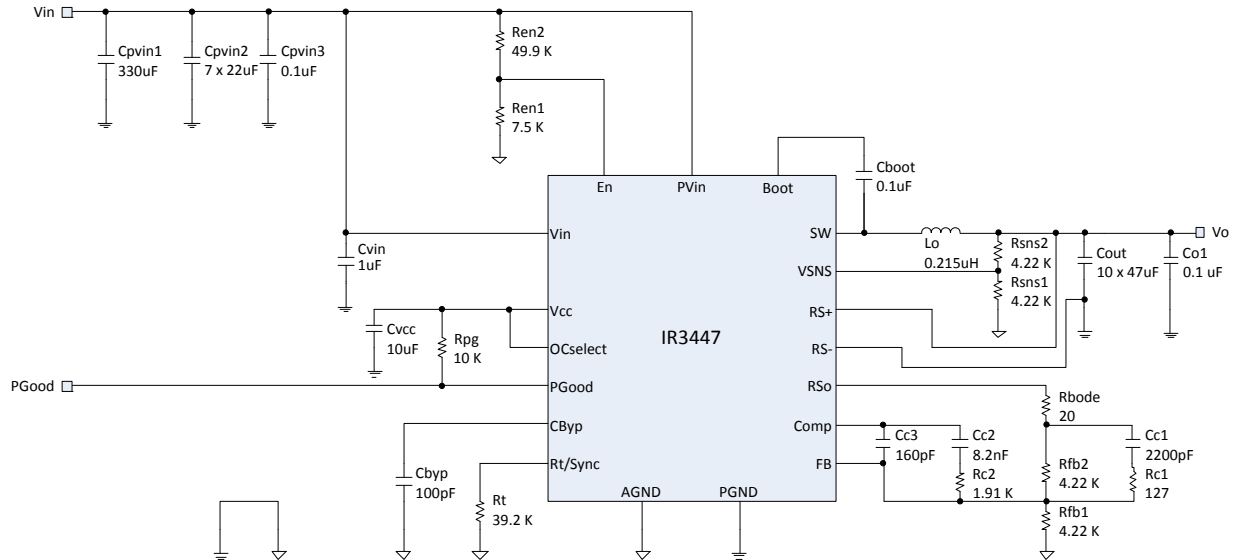

Figure 28: Application circuit for a 12V to 1.2V, 25A Point of Load Converter Using the Internal LDO

### Suggested Bill of Material for application circuit 12V to 1.2V

| Part Reference          | Qty | Value   | Description                   | Manufacturer            | Part Number        |
|-------------------------|-----|---------|-------------------------------|-------------------------|--------------------|
| Cpvin1                  | 1   | 330uF   | SMD, electrolytic, 25V, 20%   | Panasonic               | EEV-FK1E331P       |
| Cpvin2                  | 7   | 22uF    | 1206, 25V, X5R, 10%           | Murata                  | GRM31CR61E226KE15L |
| Cref                    | 1   | 100pF   | 0603, 50V, C0G, 5%            | Murata                  | GRM1885C1H101JA01D |
| Cvin                    | 1   | 1.0uF   | 0603, 25V, X5R, 20%           | Murata                  | GRM188R61E105KA12D |
| Cvcc                    | 1   | 10uF    | 0603, 10V, X5R, 20%           | TDK                     | C1608X5R1A106M     |
| Cpvin3 Cboot Co1        | 3   | 0.1uF   | 0603, 25V, X7R, 10%           | Murata                  | GRM188R71E104KA01D |
| Cc1                     | 1   | 2200pF  | 0603, 50V, X7R, 10%           | Murata                  | GRM188R71H222KA01D |
| Cc2                     | 1   | 8.2nF   | 0603, 50V, X7R, 10%           | Murata                  | GRM188R71H822KA01D |
| Cc3                     | 1   | 160pF   | 0603, 50V, NPO, 5%            | Murata                  | GRM1885C1H161JA01D |
| Cout1                   | 10  | 47uF    | 0805, 6.3V, X5R, 20%          | TDK                     | C2012X5R0J476M     |
| L0                      | 1   | 0.215uH | 10.1x7.8x7.3mm,<br>DCR=0.29mΩ | Cyntec                  | PCDC1008-R215EMO   |
| Rbd                     | 1   | 20      | Thick Film, 0603, 1/10W, 1%   | Panasonic               | ERJ-3EKF20R0V      |
| Rc1                     | 1   | 127     | Thick Film, 0603, 1/10W, 1%   | Panasonic               | ERJ-3EKF1270V      |
| Rc2                     | 1   | 1.91K   | Thick Film, 0603, 1/10W, 1%   | Panasonic               | ERJ-3EKF1911V      |
| Ren1                    | 1   | 7.5K    | Thick Film, 0603, 1/10W, 1%   | Panasonic               | ERJ-3EKF7501V      |
| Ren2                    | 1   | 49.9K   | Thick Film, 0603, 1/10W, 1%   | Panasonic               | ERJ-3EKF4992V      |
| Rfb1 Rfb2<br>Rsns1Rsns1 | 4   | 4.22K   | Thick Film, 0603, 1/10W, 1%   | Panasonic               | ERJ-3EKF4221V      |
| Rt                      | 1   | 39.2K   | Thick Film, 0603, 1/10W, 1%   | Panasonic               | ERJ-3EKF3922V      |
| Rpg                     | 1   | 10K     | Thick Film, 0603, 1/10W, 1%   | Panasonic               | ERJ-3EKF1002V      |
| U1                      | 1   | IR3447  | PQFN 5x6mm                    | International Rectifier | IR3447MPBF         |

## EXTERNALLY BIASED DUAL SUPPLIES

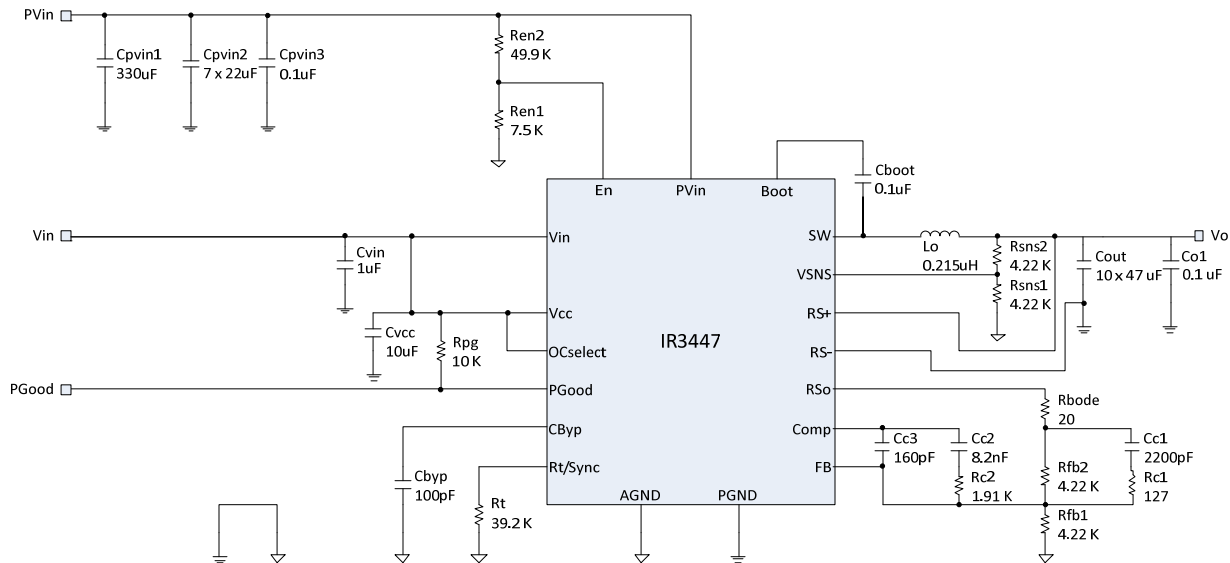

Figure 29: Application circuit for a 12V to 1.2V, 21A Point of Load Converter using external 5V VCC

### Suggested Bill of Material for application circuit 12V to 1.2V using external 5V VCC

| Part Reference       | Qty | Value   | Description                 | Manufacturer            | Part Number        |
|----------------------|-----|---------|-----------------------------|-------------------------|--------------------|
| Cpvin1               | 1   | 330uF   | SMD, electrolytic, 25V, 20% | Panasonic               | EEV-FK1E331P       |
| Cpvin2               | 7   | 22uF    | 1206, 25V, X5R, 10%         | Murata                  | GRM31CR61E226KE15L |
| Cref                 | 1   | 100pF   | 0603, 50V, C0G, 5%          | Murata                  | GRM1885C1H101JA01D |
| Cvin                 | 1   | 1.0uF   | 0603, 25V, X5R, 20%         | Murata                  | GRM188R61E105KA12D |
| Cvcc                 | 1   | 10uF    | 0603, 10V, X5R, 20%         | TDK                     | C1608X5R1A106M     |
| Cpvin3 Cboot Co1     | 3   | 0.1uF   | 0603, 25V, X7R, 10%         | Murata                  | GRM188R71E104KA01D |
| Cc1                  | 1   | 2200pF  | 0603, 50V, X7R, 10%         | Murata                  | GRM188R71H222KA01D |
| Cc2                  | 1   | 8.2nF   | 0603, 50V, X7R, 10%         | Murata                  | GRM188R71H822KA01D |
| Cc3                  | 1   | 160pF   | 0603, 50V, NPO, 5%          | Murata                  | GRM1885C1H161JA01D |
| Cout1                | 10  | 47uF    | 0805, 6.3V, X5R, 20%        | TDK                     | C2012X5R0J476M     |
| L0                   | 1   | 0.215uH | 10.1x7.8x7.3mm, DCR=0.29mΩ  | Cyntec                  | PCDC1008-R215EMO   |
| Rbd                  | 1   | 20      | Thick Film, 0603, 1/10W, 1% | Panasonic               | ERJ-3EKF20R0V      |
| Rc1                  | 1   | 52.3    | Thick Film, 0603, 1/10W, 1% | Panasonic               | ERJ-3EKF52R3V      |
| Rc2                  | 1   | 1.91K   | Thick Film, 0603, 1/10W, 1% | Panasonic               | ERJ-3EKF1911V      |
| Ren1                 | 1   | 7.5K    | Thick Film, 0603, 1/10W, 1% | Panasonic               | ERJ-3EKF7501V      |
| Ren2                 | 1   | 49.9K   | Thick Film, 0603, 1/10W, 1% | Panasonic               | ERJ-3EKF4992V      |
| Rfb1 Rfb2 Rsns1Rsns1 | 4   | 4.22K   | Thick Film, 0603, 1/10W, 1% | Panasonic               | ERJ-3EKF4221V      |
| Rt                   | 1   | 39.2K   | Thick Film, 0603, 1/10W, 1% | Panasonic               | ERJ-3EKF3922V      |
| Rpg                  | 1   | 10K     | Thick Film, 0603, 1/10W, 1% | Panasonic               | ERJ-3EKF1002V      |
| U1                   | 1   | IR3447  | PQFN 5x6mm                  | International Rectifier | IR3447MPBF         |

## EXTERNALLY BIASED SINGLE SUPPLY

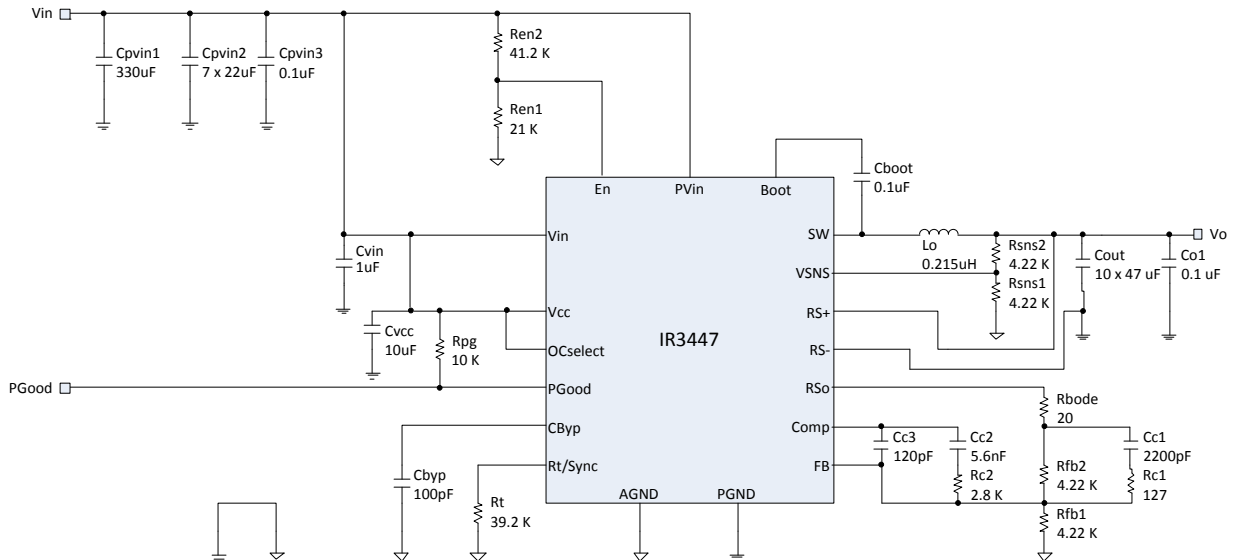

Figure 30: Application circuit for a 5V to 1.2V, 21A Point of Load Converter

Suggested bill of material for application circuit 5V to 1.2V

| Part Reference          | Qty | Value   | Description                   | Manufacturer            | Part Number        |
|-------------------------|-----|---------|-------------------------------|-------------------------|--------------------|
| Cpvin1                  | 1   | 330uF   | SMD, electrolytic, 25V, 20%   | Panasonic               | EEV-FK1E331P       |
| Cpvin2                  | 7   | 22uF    | 1206, 25V, X5R, 10%           | Murata                  | GRM31CR61E226KE15L |
| Cref                    | 1   | 100pF   | 0603, 50V, C0G, 5%            | Murata                  | GRM1885C1H101JA01D |
| Cvin                    | 1   | 1.0uF   | 0603, 25V, X5R, 20%           | Murata                  | GRM188R61E105KA12D |
| Cvcc                    | 1   | 10uF    | 0603, 10V, X5R, 20%           | TDK                     | C1608X5R1A106M     |
| Cpvin3 Cboot Co1        | 3   | 0.1uF   | 0603, 25V, X7R, 10%           | Murata                  | GRM188R71E104KA01D |
| Cc1                     | 1   | 2200pF  | 0603, 50V, X7R, 10%           | Murata                  | GRM188R71H222KA01D |
| Cc2                     | 1   | 5.6nF   | 0603, 50V, X7R, 10%           | Murata                  | GRM188R71H562KA01D |
| Cc3                     | 1   | 120pF   | 0603, 50V, NPO, 5%            | Murata                  | GRM1885C1H121JA01D |
| Cout1                   | 10  | 47uF    | 0805, 6.3V, X5R, 20%          | TDK                     | C2012X5R0J476M     |
| L0                      | 1   | 0.215uH | 10.1x7.8x7.3mm,<br>DCR=0.29mΩ | Cyntec                  | PCDC1008-R215EMO   |
| Rbd                     | 1   | 20      | Thick Film, 0603, 1/10W, 1%   | Panasonic               | ERJ-3EKF20R0V      |
| Rc1                     | 1   | 127     | Thick Film, 0603, 1/10W, 1%   | Panasonic               | ERJ-3EKF1270V      |
| Rc2                     | 1   | 2.8K    | Thick Film, 0603, 1/10W, 1%   | Panasonic               | ERJ-3EKF2801V      |
| Ren1                    | 1   | 21K     | Thick Film, 0603, 1/10W, 1%   | Panasonic               | ERJ-3EKF2102V      |
| Ren2                    | 1   | 41.2K   | Thick Film, 0603, 1/10W, 1%   | Panasonic               | ERJ-3EKF4122V      |
| Rfb1 Rfb2<br>Rsns1Rsns1 | 4   | 4.22K   | Thick Film, 0603, 1/10W, 1%   | Panasonic               | ERJ-3EKF4221V      |
| Rt                      | 1   | 39.2K   | Thick Film, 0603, 1/10W, 1%   | Panasonic               | ERJ-3EKF3922V      |
| Rpg                     | 1   | 10K     | Thick Film, 0603, 1/10W, 1%   | Panasonic               | ERJ-3EKF1002V      |
| U1                      | 1   | IR3447  | PQFN 5x6mm                    | International Rectifier | IR3447MPBF         |

## TYPICAL OPERATING WAVEFORMS

$V_{in}=P_{Vin}=12V$ ,  $V_{out}=1.2V$ ,  $I_{out}=0-25A$ ,  $F_s=600kHz$ , Room Temperature, No Air Flow

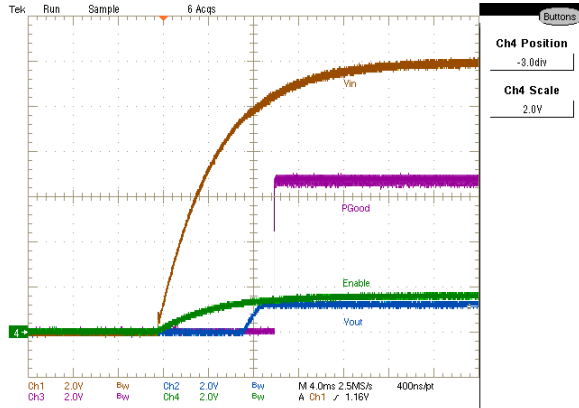

Figure 31: Startup with full load, Enable Signal  
CH1:Vin, CH2:Vout, CH3:PGood, CH4:Enable

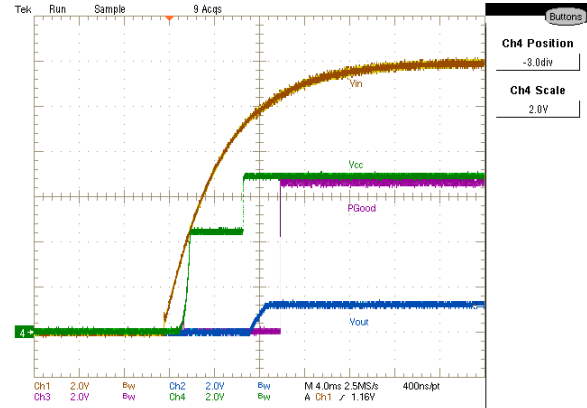

Figure 32: Startup with full load, VCC signal  
CH1:Vin, CH2:Vout, CH3:PGood, CH4:VCC

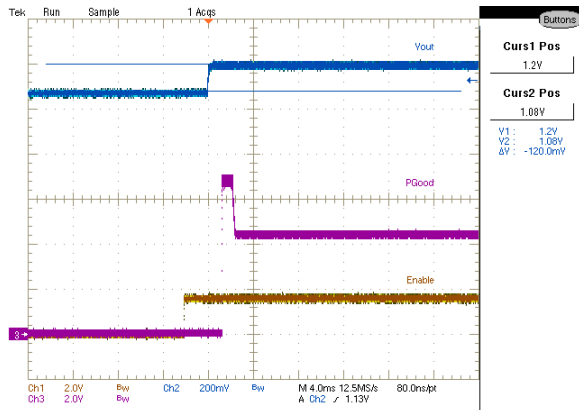

Figure 33: Vout Startup with Pre-Bias, 1.08V  
CH1: Enable, CH2:Vout, CH3:PGood

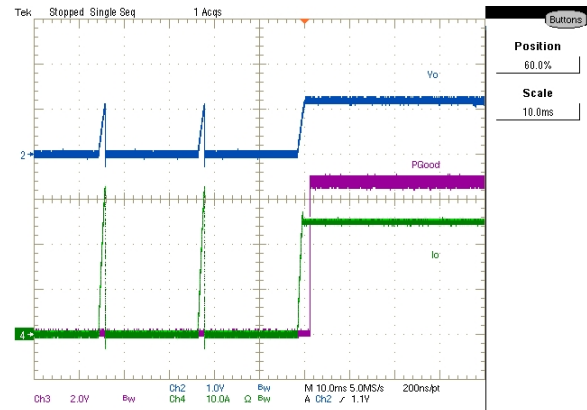

Figure 34: Recovery from Hiccup  
CH2:Vout, CH3:PGood, CH4:Iout

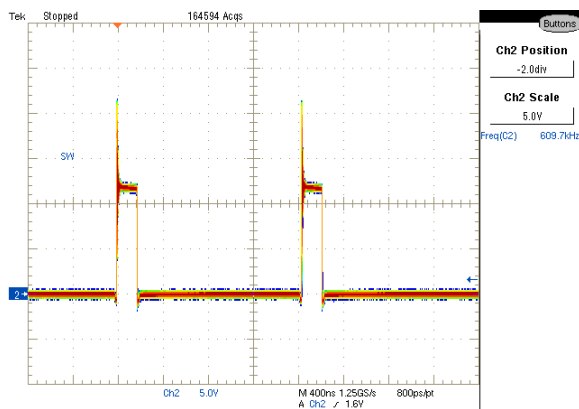

Figure 35: Inductor Switch Node at full load  
CH2:SW

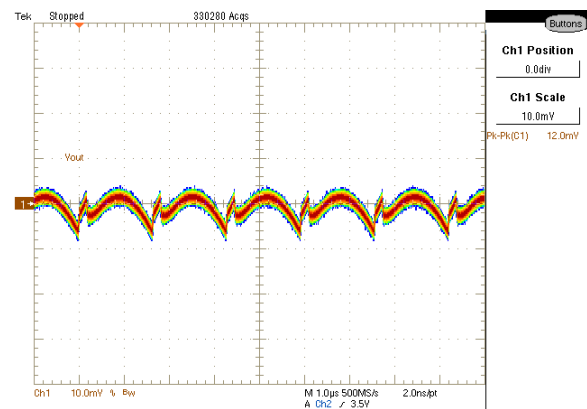

Figure 36: Output Voltage Ripple at full load  
CH1:Vout

## TYPICAL OPERATING WAVEFORMS

Vin=PVin=12V, Vout=1.2V, Iout=2.5A-10A, Fs=600kHz, Room Temperature, No air flow

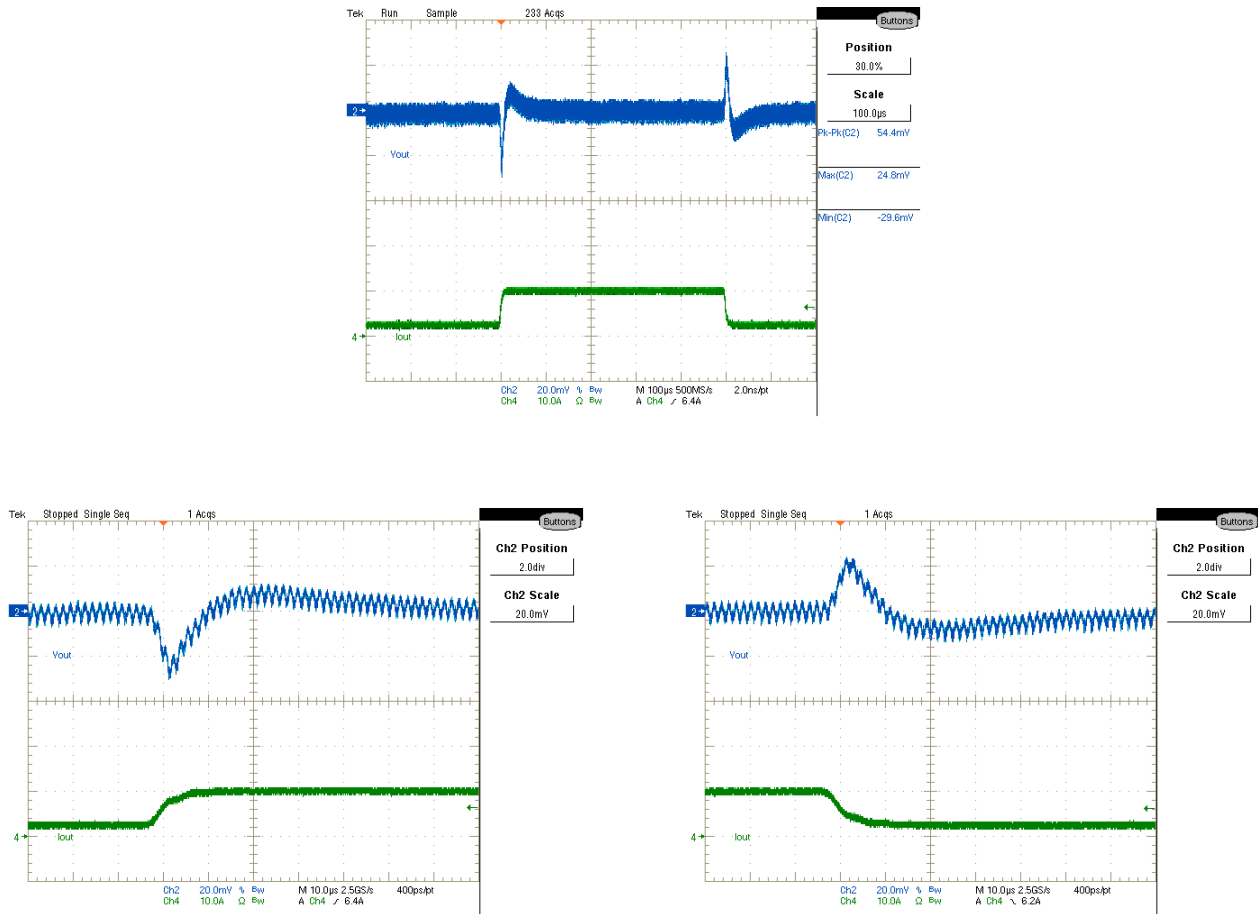

Figure 37: Vout Transient Response, 2.5A to 10.0A step at 2.5A/uSec  
**CH2:Vout, CH4:Iout (10A/V)**

## TYPICAL OPERATING WAVEFORMS

$V_{in}=P_{Vin}=12V$ ,  $V_{out}=1.2V$ ,  $I_{out}=17.5A-25A$ ,  $F_s=600kHz$ , Room Temperature, No air flow

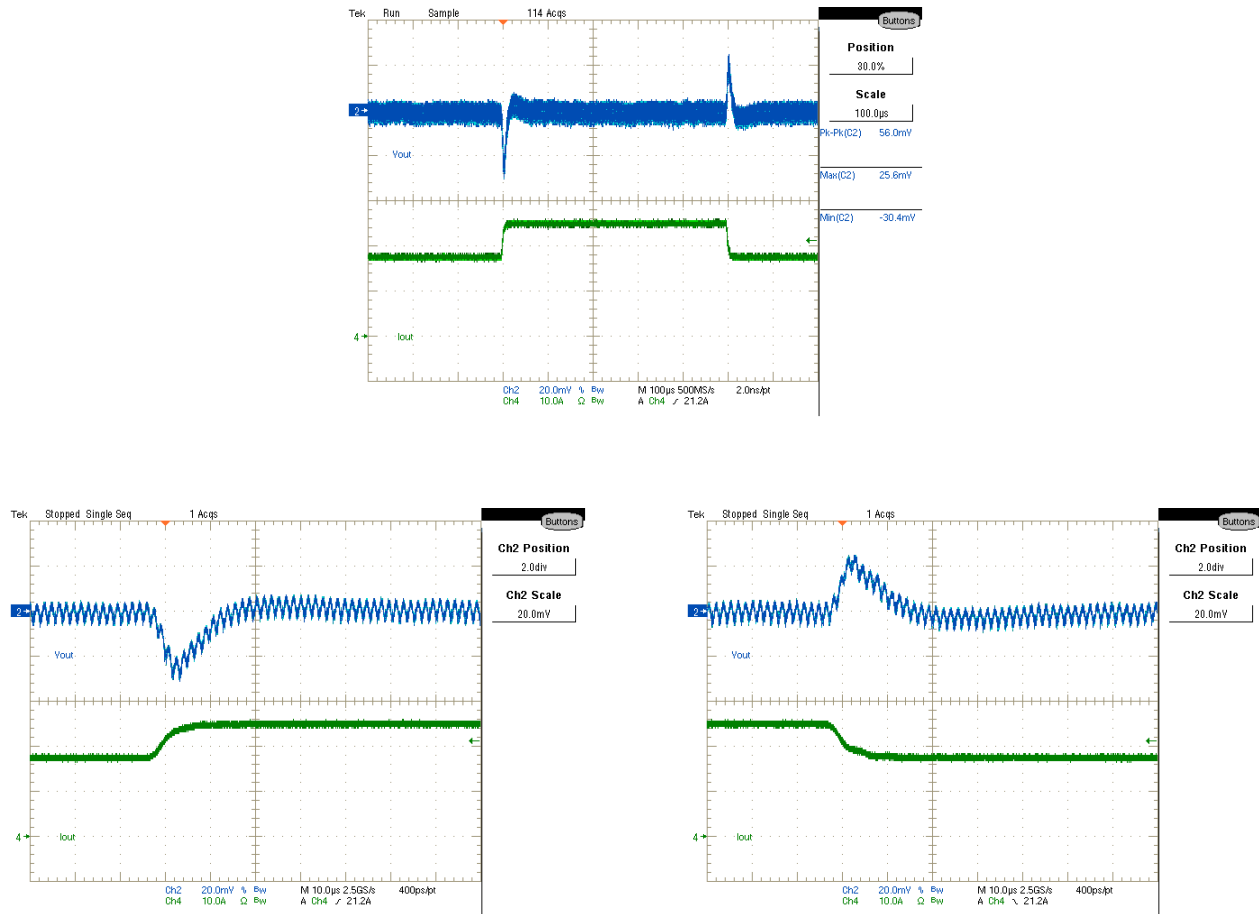

Figure 38: Vout Transient Response, 17.5A to 25A step at 2.5A/uSec  
**CH2:Vout, CH4:Iout (10A/V)**

## TYPICAL OPERATING WAVEFORMS

Vin=PVin=12V, Vout=1.2V, Iout=25A, Fs=600kHz, Room Temperature, No air flow

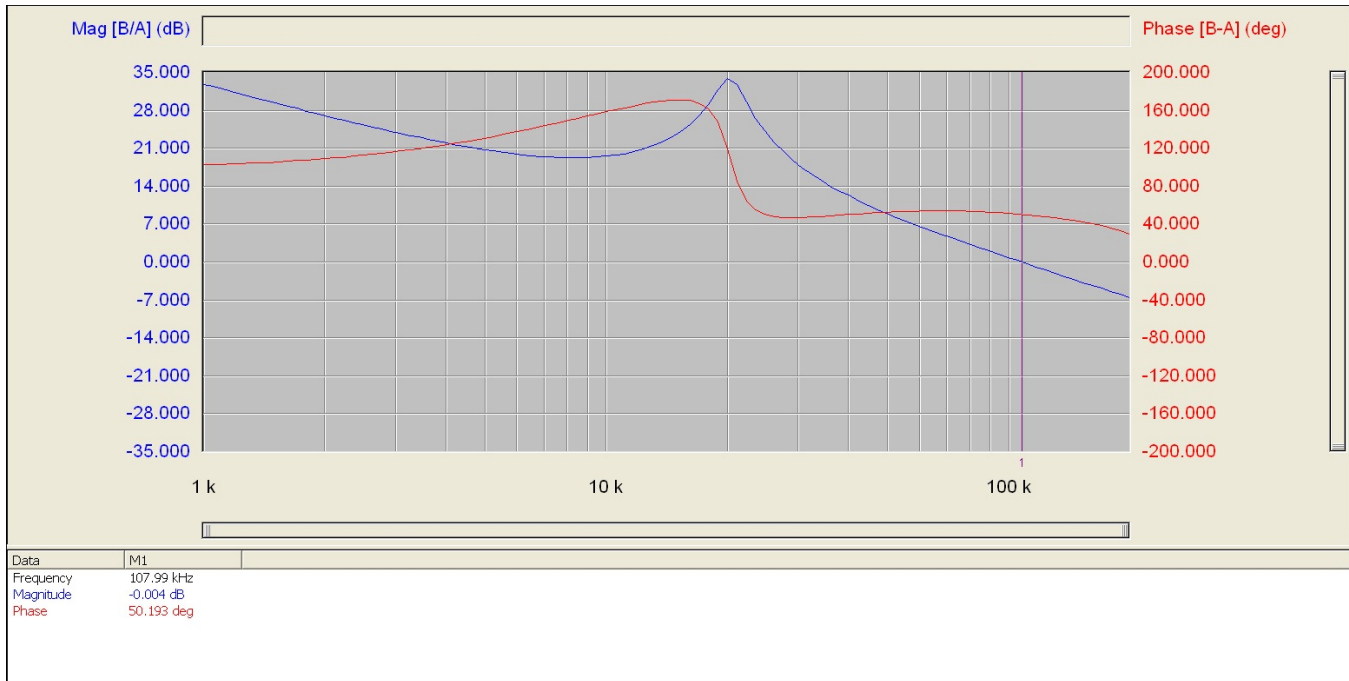

Figure 39: Bode Plot with 25A load: Fo=108 kHz, Phase Margin=50.2 Degrees

### TYPICAL OPERATING WAVEFORMS

$V_{in}=P_{Vin}=12V$ ,  $V_{out}=1.2V$ ,  $I_{out}=0-25A$ ,  $F_s=600kHz$ , Room Temperature, No air flow

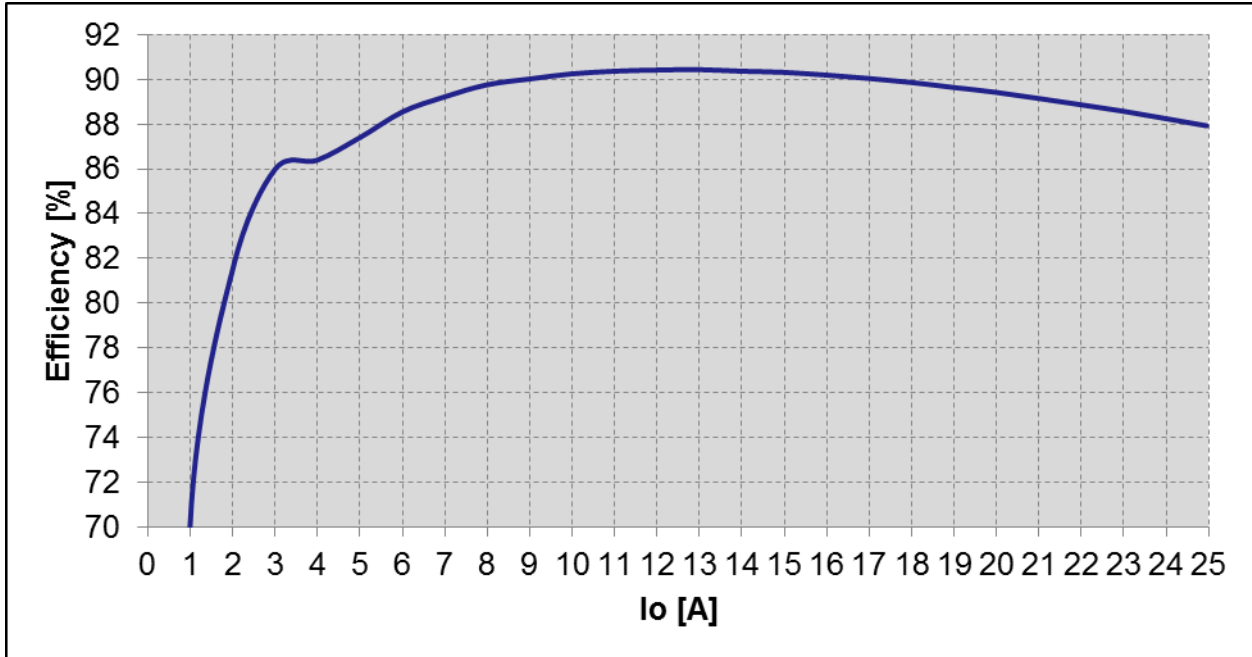

Figure 40: Efficiency versus load current

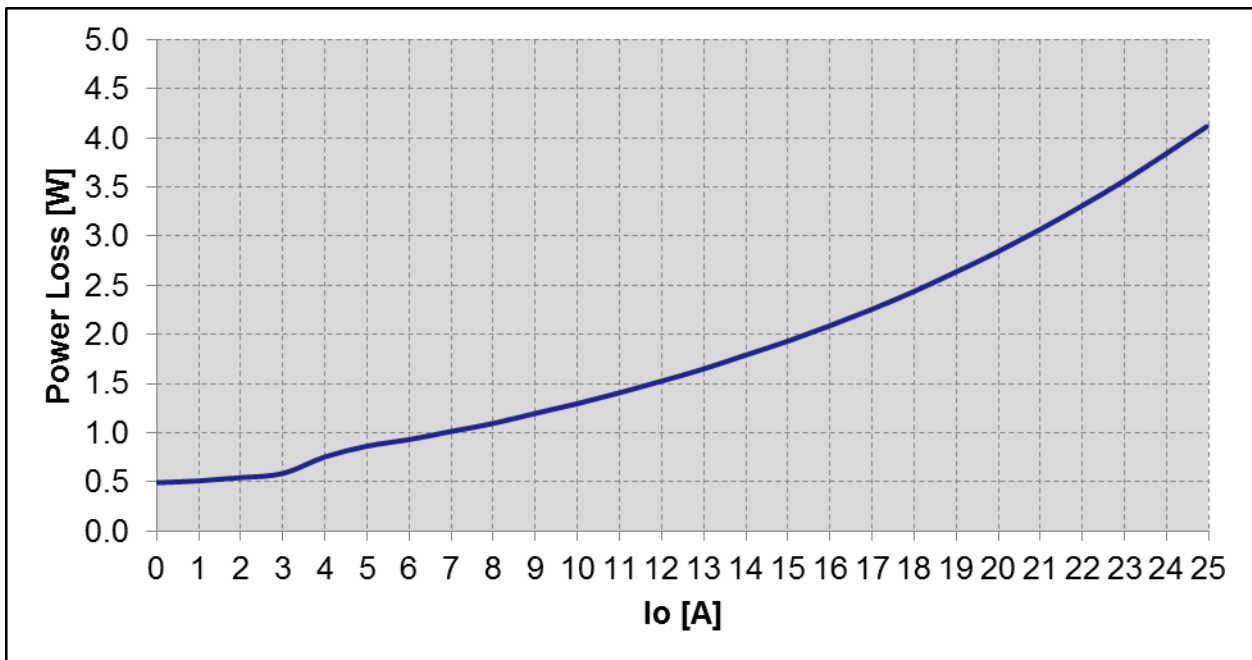

Figure 41: Power Loss versus load current

## LAYOUT RECOMMENDATIONS

The layout is very important when designing high frequency switching converters. Layout will affect noise pickup and can cause a good design to perform with less than expected results.

Make the connections for the power components in the top layer with wide, copper filled areas or polygons. In general, it is desirable to make proper use of power planes and polygons for power distribution and heat dissipation.

The inductor, input capacitors, output capacitors and the IR3447 should be as close to each other as possible. This helps to reduce the EMI radiated by the power traces due to the high switching currents through them. Place the input capacitor directly at the PVin pin of IR3447.

The feedback part of the system should be kept away from the inductor and other noise sources.

The critical bypass components such as capacitors for PVin, Vin and VCC should be close to their respective

pins. It is important to place the feedback components including feedback resistors and compensation components close to Fb and Comp pins.

In a multilayer PCB use at least one layer as a power ground plane and have a control circuit ground (analog ground), to which all signals are referenced. The goal is to localize the high current path to a separate loop that does not interfere with the more sensitive analog control function. These two grounds must be connected together on the PC board layout at a single point. It is recommended to place all the compensation parts over the analog ground plane in top layer.

The Power QFN is a thermally enhanced package. Based on thermal performance it is recommended to use at least a 6-layers PCB. To effectively remove heat from the device the exposed pad should be connected to the ground plane using vias. Figure 42a-f illustrates the implementation of the layout guidelines outlined above, on the IRDC3447 6-layer demo board.

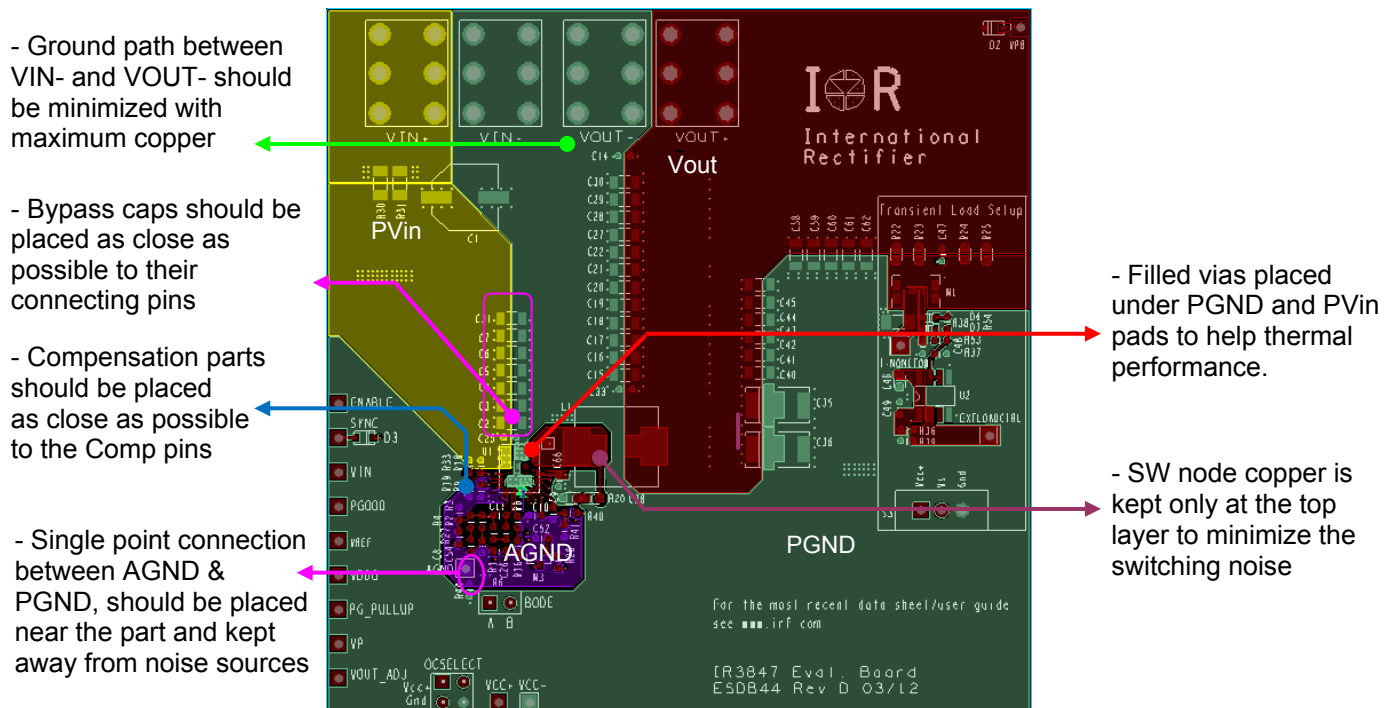

Figure 42a: IRDC3447 Demo board Layout Considerations – Top Layer

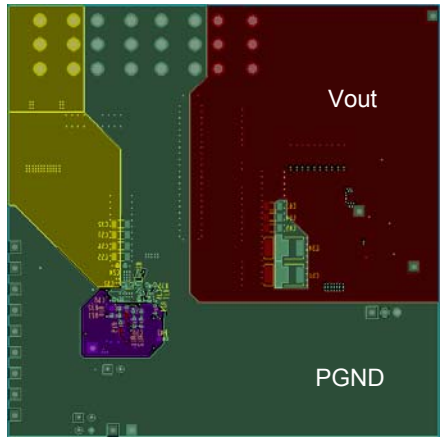

Figure 42b: IRDC3447 Demo board Layout Considerations – Bottom Layer

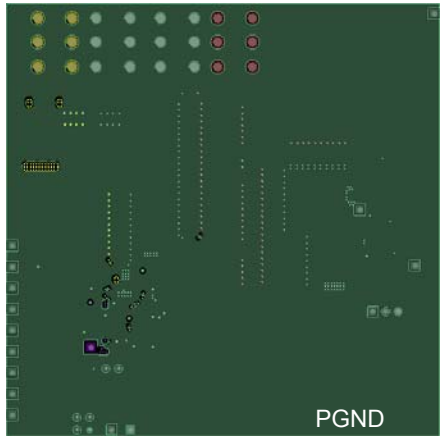

Figure 42c: IRDC3447 Demo board Layout Considerations – Mid Layer 1

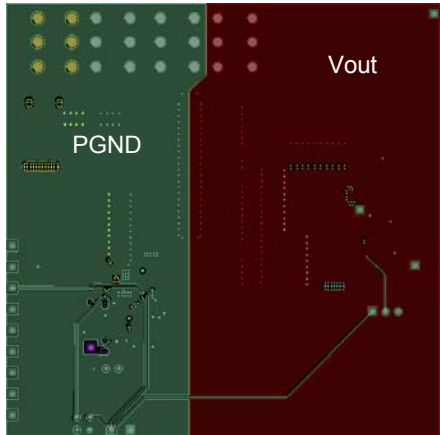
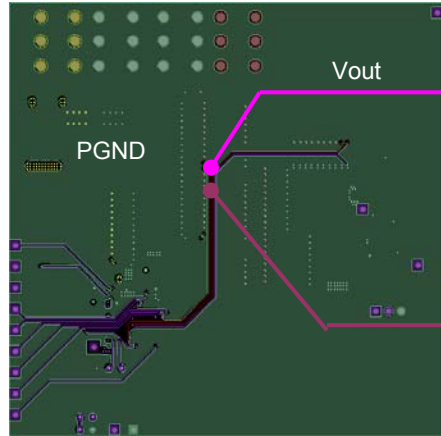

Figure 42d: IRDC3447 Demo board Layout Considerations – Mid Layer 2



-Feedback and Vsns traces routing should be kept away from noise sources

- Remote Sense Traces
- tap output where voltage value is critical.
  - Avoid noisy areas and noise coupling.
  - RS+ and RS- lines near each other.
  - Minimize trace resistance.

Figure 42e: IRDC3447 Demo board Layout Considerations – Mid Layer 3

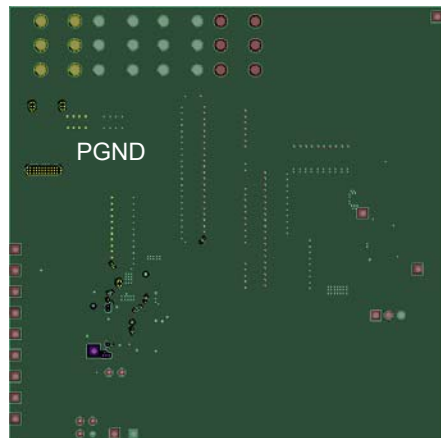

Figure 42f: IRDC3447 Demo board Layout Considerations – Mid Layer 4

## PCB METAL AND COMPONENT PLACEMENT

Evaluations have shown that the best overall performance is achieved using the substrate/PCB layout as shown in following figures. PQFN devices should be placed to an accuracy of 0.050mm on both X and Y axes. Self-centering behavior is highly dependent on solders and processes, and

experiments should be run to confirm the limits of self-centering on specific processes. For further information, please refer to “SupIRBuck™ Multi-Chip Module (MCM) Power Quad Flat No-Lead (PQFN) Board Mounting Application Note.” **(AN1132)**

**PCB PAD SIZES (DETAIL 1)**

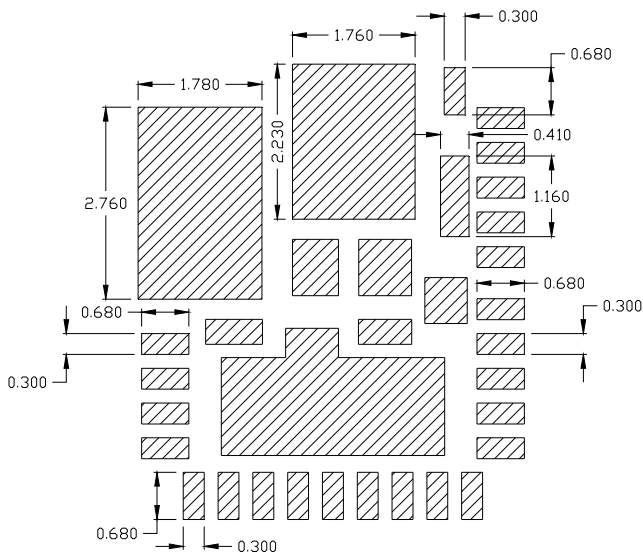

**PCB PAD SIZES (DETAIL 2)**

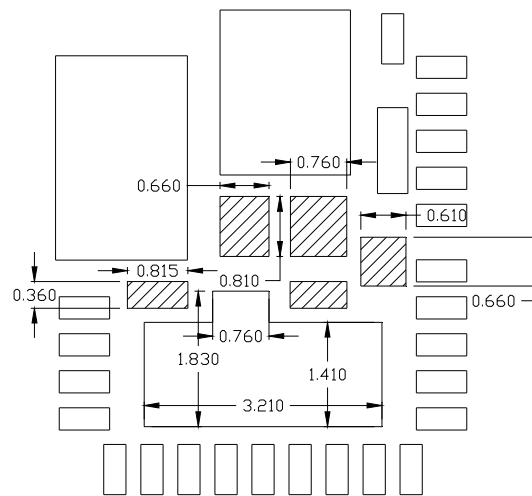

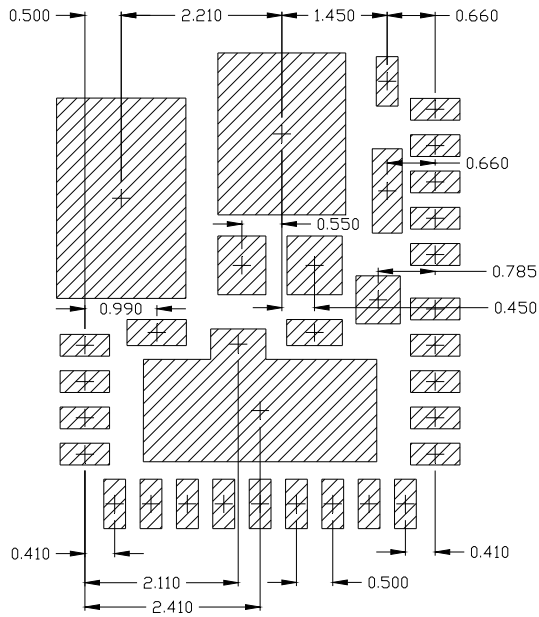
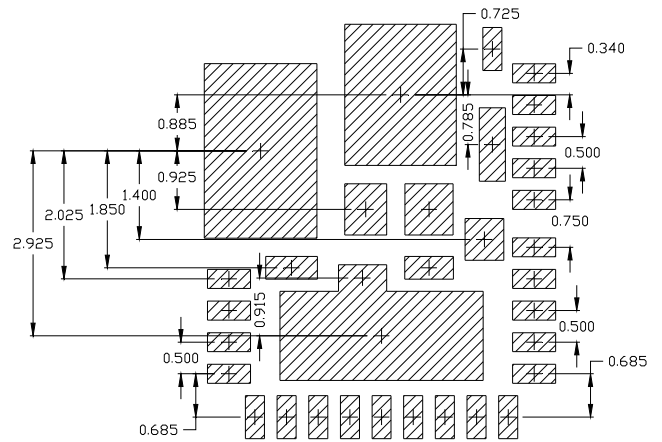
**PCB PAD SPACING (DETAIL 1)**

**PCB PAD SPACING (DETAIL 2)**

## SOLDER RESIST

- IR recommends that the larger Power or Land Area pads are Solder Mask Defined (SMD). This allows the underlying Copper traces to be as large as possible, which helps in terms of current carrying capability and device cooling capability.
- When using SMD pads, the underlying copper traces should be at least 0.05mm larger (on each edge) than the Solder Mask window, in order to accommodate any layer to layer misalignment. (i.e. 0.1mm in X & Y).
- However, for the smaller Signal type leads around the edge of the device, IR recommends that these are Non Solder Mask Defined or Copper Defined.
- When using NSMD pads, the Solder Resist Window should be larger than the Copper Pad by at least 0.025mm on each edge, (i.e. 0.05mm in X & Y), in order to accommodate any layer to layer misalignment.
- Ensure that the solder resist in-between the smaller signal lead areas are at least 0.15mm wide, due to the high x/y aspect ratio of the solder mask strip.

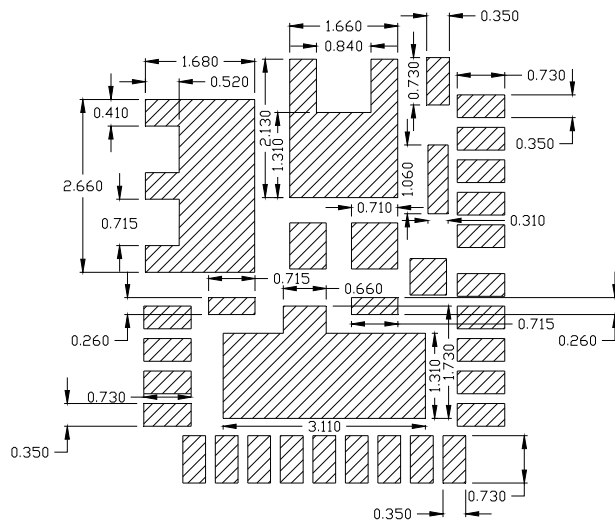
**SOLDER MASK DESIGN  
PAD SIZES (DETAIL 1)**



**SOLDER MASK DESIGN  
PAD SIZES (DETAIL 2)**

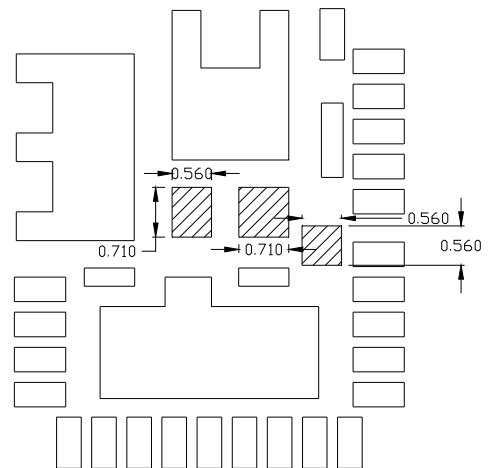

**SOLDER MASK DESIGN  
PAD SPACING (DETAIL 1)**

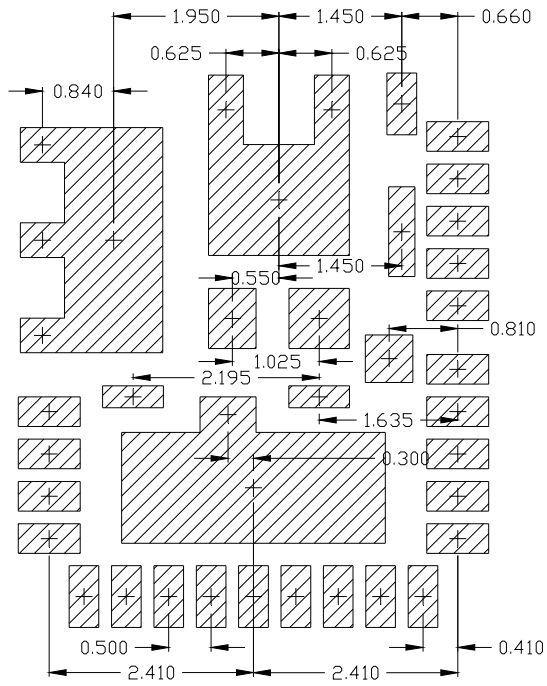

**SOLDER MASK DESIGN  
PAD SPACING (DETAIL 2)**

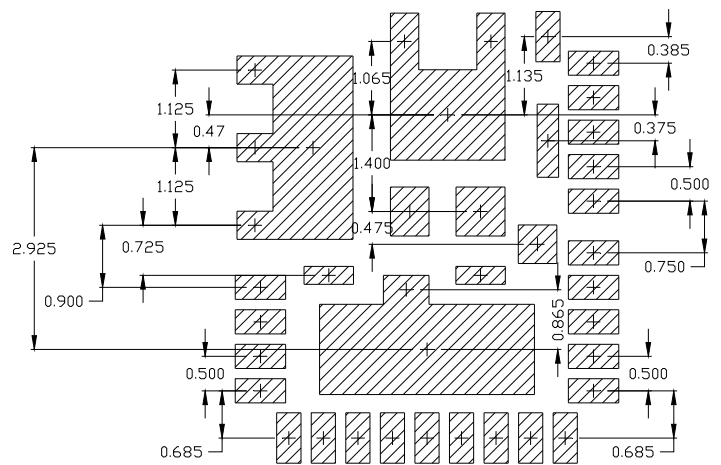

## STENCIL DESIGN

- Stencils for PQFN can be used with thicknesses of 0.100-0.250mm (0.004-0.010"). Stencils thinner than 0.100mm are unsuitable because they deposit insufficient solder paste to make good solder joints with the ground pad; high reductions sometimes create similar problems. Stencils in the range of 0.125mm-0.200mm (0.005-0.008"), with suitable reductions, give best results.
- Evaluations have shown that the best overall performance is achieved using the stencil design shown in following figure. This design for a stencil thickness of 0.127mm (0.005"). The reduction should be adjusted for stencils of other thicknesses.

**SOLDER PASTE STENCIL  
PAD SIZES (DETAIL 1)**

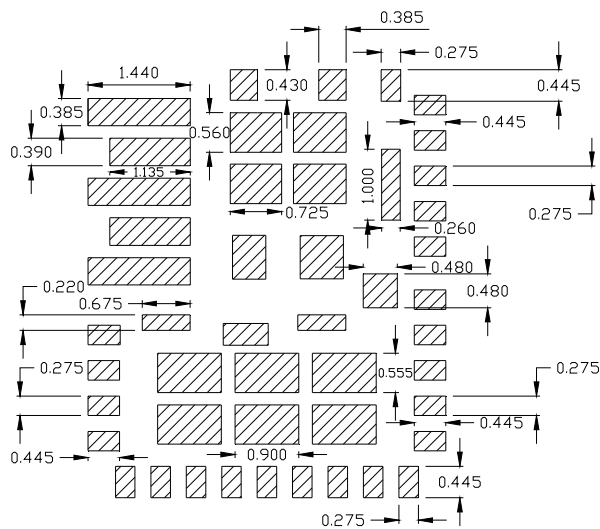

**SOLDER PASTE STENCIL  
PAD SIZES (DETAIL 2)**

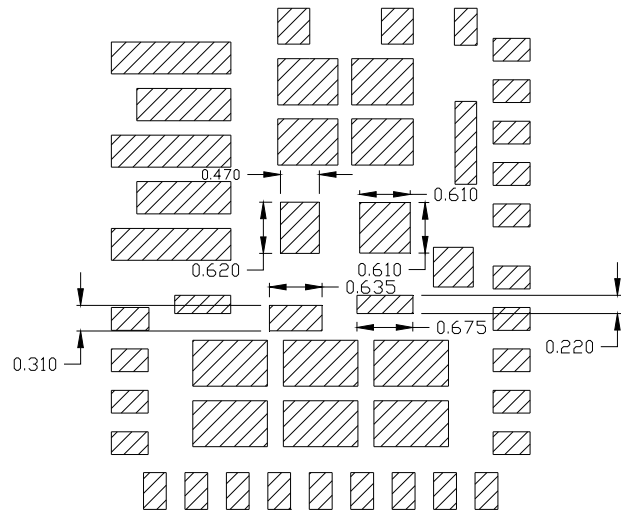

**SOLDER PASTE STENCIL  
PAD SPACING (DETAIL 1)**

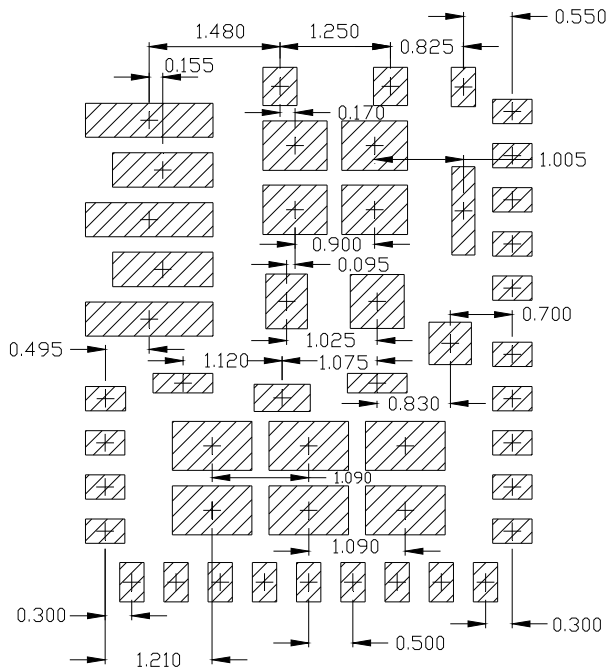

**SOLDER PASTE STENCIL  
PAD SPACING (DETAIL 2)**

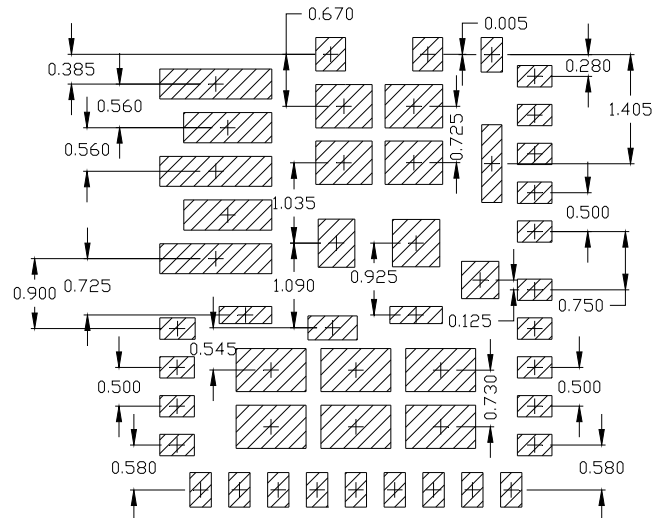

**MARKING INFORMATION**

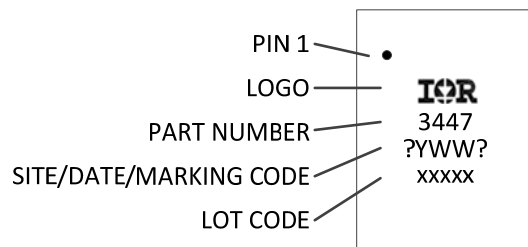
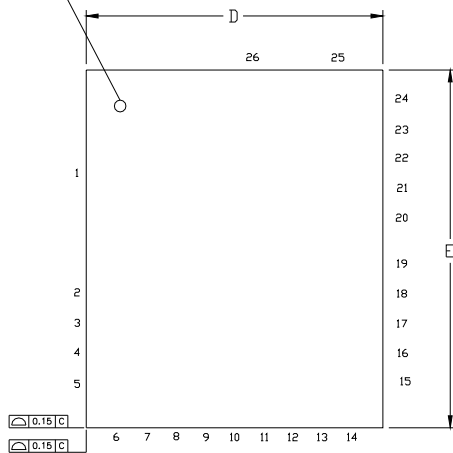

Figure 43: Marking Information

# PACKAGING INFORMATION

Pin 1 indicator mark area



TOP VIEW

| DIM | MILLIMETERS |       | INCHES      |       |
|-----|-------------|-------|-------------|-------|
|     | MIN         | MAX   | MIN         | MAX   |
| A   | 0.800       | 1.000 | .0315       | .0394 |
| A1  | 0.000       | 0.050 | .0000       | .0020 |
| b   | 0.300       | 0.400 | .0118       | .0157 |
| b1  | 0.200       | 0.300 | .0079       | .0118 |
| c   | 0.203 REF.  |       | .0080 REF.  |       |
| D   | 5.000 BASIC |       | .1969 BASIC |       |
| E   | 6.000 BASIC |       | .2362 BASIC |       |
| e   | 1.125 BASIC |       | .0443 BASIC |       |
| e1  | 0.500 BASIC |       | .0197 BASIC |       |
| e2  | 0.750 BASIC |       | .0295 BASIC |       |
| e3  | 1.250 BASIC |       | .0492 BASIC |       |
| t   | 0.400 BASIC |       | .0157 BASIC |       |
| t1  | 0.650 BASIC |       | .0256 BASIC |       |
| t2  | 0.375 BASIC |       | .0148 BASIC |       |
| t3  | 0.350 BASIC |       | .0136 BASIC |       |
| t4  | 0.625 BASIC |       | .0246 BASIC |       |
| t5  | 2.000 BASIC |       | .0787 BASIC |       |
| L   | 0.350       | 0.450 | .0136       | .0177 |
| M   | 1.350       | 1.450 | .0531       | .0571 |
| M1  | 1.550       | 1.650 | .0610       | .0650 |
| N   | 1.800       | 1.900 | .0709       | .0748 |
| O   | 1.350       | 1.450 | .0531       | .0571 |
| P   | 2.550       | 2.650 | .1004       | .1043 |
| Q   | 0.700       | 0.800 | .0276       | .0315 |
| Q1  | 1.950       | 2.050 | .0768       | .0807 |
| Q2  | 2.370       | 2.470 | .0933       | .0972 |

| DIM | MILLIMETERS |       | INCHES |       |
|-----|-------------|-------|--------|-------|
|     | MIN         | MAX   | MIN    | MAX   |
| R   | 0.925       | 1.025 | .0364  | .0404 |
| R1  | 1.850       | 1.950 | .0728  | .0768 |
| R2  | 2.450       | 2.550 | .0965  | .1004 |
| R3  | 3.975       | 4.075 | .1565  | .1604 |
| S   | 2.300       | 2.400 | .0906  | .0945 |
| S1  | 2.500       | 2.600 | .0984  | .1024 |
| T   | 0.700       | 0.800 | .0276  | .0315 |
| T1  | 0.606       | 0.706 | .0239  | .0278 |
| T2  | 1.491       | 1.591 | .0587  | .0626 |
| T3  | 0.600       | 0.700 | .0236  | .0276 |
| U   | 2.250       | 2.350 | .0886  | .0925 |
| U1  | 0.600       | 0.700 | .0236  | .0276 |
| V   | 1.350       | 1.450 | .0531  | .0571 |
| V1  | 0.600       | 0.700 | .0236  | .0276 |
| V2  | 0.400       | 0.500 | .0157  | .0197 |
| V3  | 0.450       | 0.550 | .0177  | .0217 |
| W   | 2.800       | 2.900 | .1102  | .1142 |
| W1  | 0.450       | 0.550 | .0177  | .0217 |
| X   | 0.600       | 0.700 | .0236  | .0276 |
| X1  | 0.450       | 0.550 | .0177  | .0217 |
| Y   | 1.050       | 1.150 | .0413  | .0453 |
| Y1  | 0.950       | 1.050 | .0374  | .0413 |
| Z   | 0.200       | 0.300 | .0079  | .0118 |

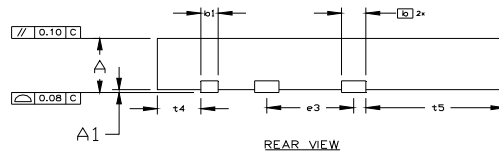

REAR VIEW

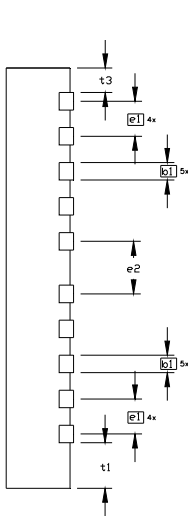

SIDE VIEW

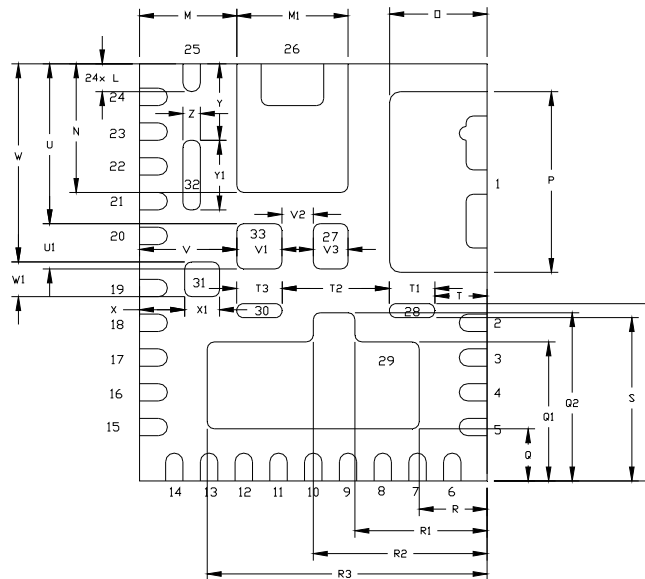

BOTTOM VIEW



SIDE VIEW

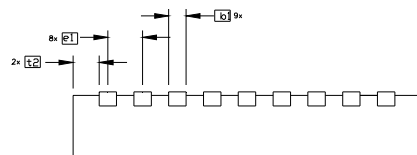

FRONT VIEW

## ENVIRONMENTAL QUALIFICATIONS

|                                   |  |                  |      |
|-----------------------------------|--|------------------|------|
| <b>Qualification Level</b>        |  | Industrial       |      |
| <b>Moisture Sensitivity Level</b> |  | 5mm x 6mm PQFN   | MSL3 |
| <b>ESD</b>                        | Machine Model<br>(JESD22-A115A)        | Class A          |      |
|                                   |  | <200V            |      |
|                                   | Human Body Model<br>(JESD22-A114F)     | Class 1C         |      |
|                                   |  | ≥1000V to <2000V |      |
|                                   | Charged Device Model<br>(JESD22-C101D) | Class III        |      |
| ≥500V to ≤1000V                   |  |                  |      |
| <b>RoHS Compliant</b>             |  | Yes              |      |

Data and specifications subject to change without notice.  
Qualification Standards can be found on IR's Web site.

International  
 Rectifier

**IR WORLD HEADQUARTERS:** 233 Kansas St., El Segundo, California 90245, USA Tel: (310) 252-7105

TAC Fax: (310) 252-7903

Visit us at [www.irf.com](http://www.irf.com) for sales contact information.

[www.irf.com](http://www.irf.com)

## Looking for pricing, stock, or lifecycle information?

Click below to explore more details on WIN SOURCE:

 [View IR3447MTR1PBF on WIN SOURCE](#)

 [Infineon Technologies](#) Information

## Optimize Your Supply Chain with WIN SOURCE Solutions

-  Global Sourcing Solution
-  Obsolete Management
-  Cost Control Management
-  Shortage Management
-  Alternative Solution
-  Excess Inventory Management