



**THE DATASHEET OF  
IR3831WMTRPBF**



# Sup $IR$ Buck™

## HIGHLY EFFICIENT INTEGRATED SYNCHRONOUS BUCK REGULATOR FOR DDR APPLICATIONS

### Features

- Wide Input Voltage Range 1.0V to 16V
- Wide Output Voltage Range 0.6V to 0.9\*Vin
- Continuous 8A Load Capability
- Integrated Bootstrap-diode
- High Bandwidth E/A for excellent transient performance
- Programmable Switching Frequency up to 1.5 MHz
- Programmable Over Current Protection
- PGood output
- Hiccup Current Limit
- Programmable Soft-Start
- Enable Input with Voltage Monitoring Capability
- Enhanced Pre-Bias Start-up
- Vp input for DDR Tracking applications
- -40°C to 125°C operating junction temperature
- Thermal Protection
- 5mm x 6mm Power QFN Package, 0.9 mm height
- Lead-free, halogen-free and RoHS compliant

### Description

The IR3831W **Sup $IR$ Buck™** is an easy-to-use, fully integrated and highly efficient DC/DC regulator. The MOSFETS co-packaged with the on-chip PWM controller make IR3831W a space-efficient solution, providing accurate power delivery for DDR memory applications.

IR3831W is configured to generate termination voltage (VTT) for DDR memory applications.

IR3831W offers programmability of start up time, switching frequency and current limit while operating in wide input and output voltage range.

The switching frequency is programmable from 250kHz to 1.5MHz for an optimum solution.

It also features important protection functions, such as Pre-Bias startup, hiccup current limit and thermal shutdown to give required system level security in the event of fault conditions.

### Applications

- Server Applications
- Storage Applications
- Embedded Telecom Systems
- Distributed Point of Load Power Architectures
- Netcom Applications

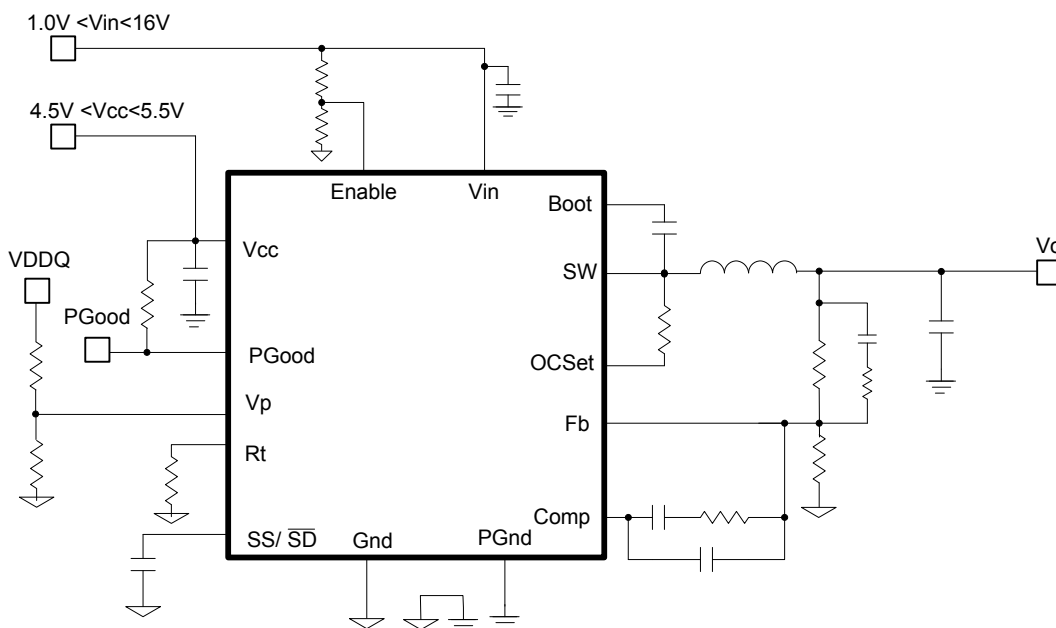

Fig. 1. Typical application diagram

### ABSOLUTE MAXIMUM RATINGS

(Voltages referenced to GND unless otherwise specified)

- Vin ..... -0.3V to 25V
- Vcc ..... -0.3V to 8V (Note2)
- Boot ..... -0.3V to 33V
- SW ..... -0.3V to 25V(DC), -4V to 25V(AC, 100ns)
- Boot to SW ..... -0.3V to Vcc+0.3V (Note1)
- OCSet ..... -0.3V to 30V, 30mA
- Input / output Pins ..... -0.3V to Vcc+0.3V (Note1)
- PGND to GND ..... -0.3V to +0.3V
- Storage Temperature Range ..... -55°C To 150°C
- Junction Temperature Range ..... -40°C To 150°C (Note2)
- ESD Classification ..... JEDEC Class 1C
- Moisture sensitivity level.....JEDEC Level 2@260 °C (Note5)

**Note1:** Must not exceed 8V

**Note2:** Vcc must not exceed 7.5V for Junction Temperature between -10°C and -40°C

Stresses beyond those listed under “Absolute Maximum Ratings” may cause permanent damage to the device. These are stress ratings only and functional operation of the device at these or any other conditions beyond those indicated in the operational sections of the specifications are not implied.

### PACKAGE INFORMATION

5mm x 6mm POWER QFN

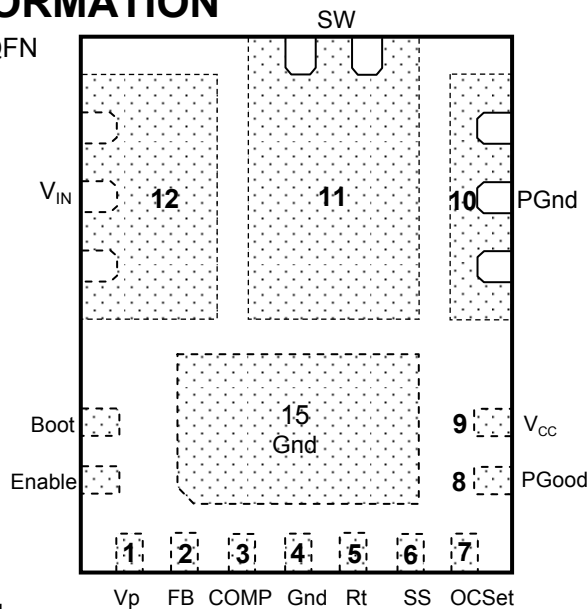

$$\theta_{JA} = 35^{\circ}\text{C} / \text{W}$$

$$\theta_{J-PCB} = 2^{\circ}\text{C} / \text{W}$$

### ORDERING INFORMATION

PACKAGE DESIGNATOR	PACKAGE DESCRIPTION	PIN COUNT	PARTS PER REEL
M	IR3831WMTRPbF	15	4000
M	IR3831WMTR1PbF	15	750

### Block Diagram

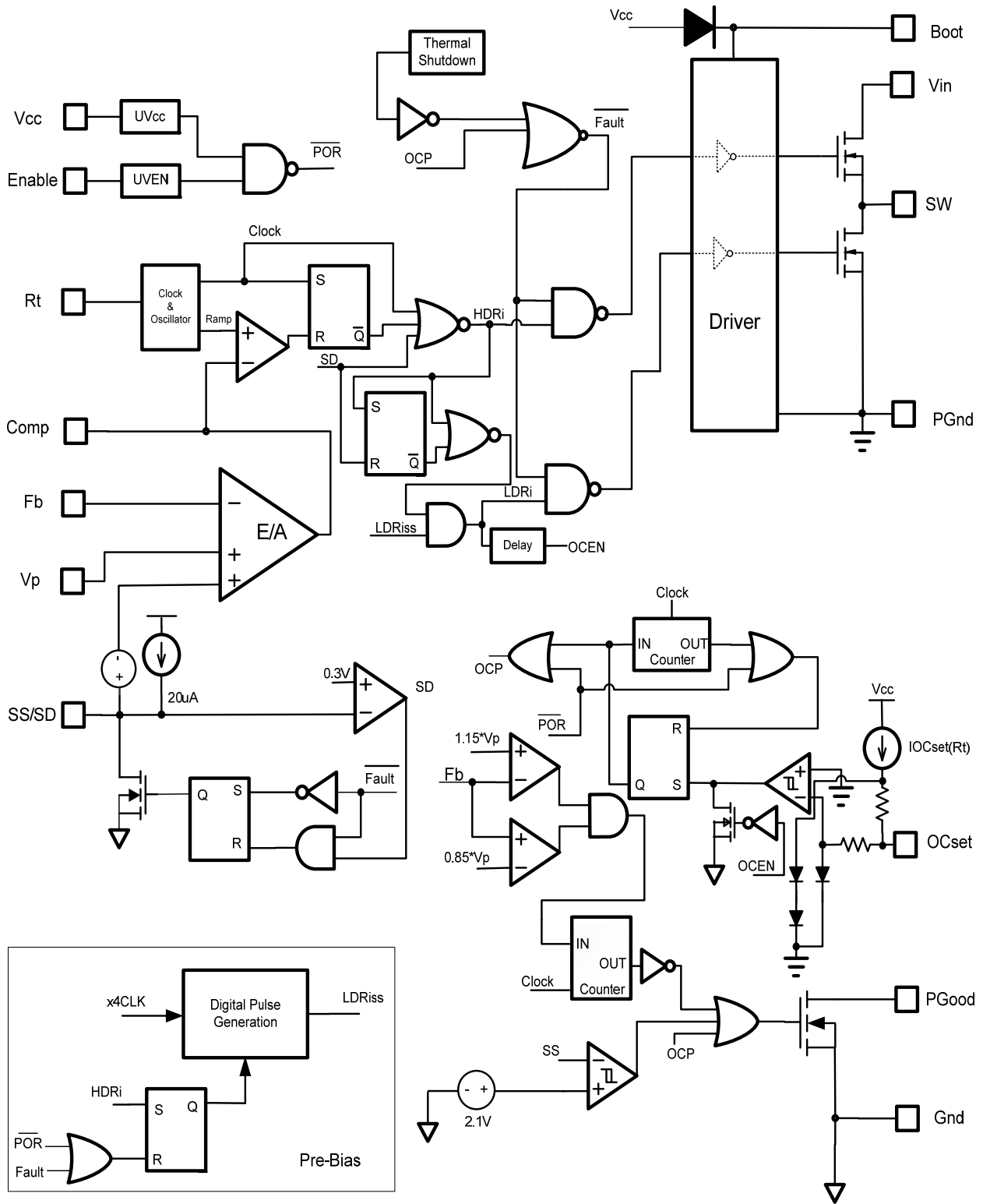

Fig. 2. Simplified block diagram of the IR3831W

## Pin Description

Pin	Name	Description
1	Vp	Track pin. Use External resistors from VDDQ rail. The Vp voltage can be set to 0.9V for DDR2 application and 0.75 or 0.6V for DDR3 application.
2	Fb	Inverting input to the error amplifier. This pin is connected directly to the output of the regulator via resistor divider to set the output voltage and provide feedback to the error amplifier.
3	Comp	Output of error amplifier. An external resistor and capacitor network is typically connected from this pin to Fb pin to provide loop compensation.
4	Gnd	Signal ground for internal reference and control circuitry.
5	Rt	Set the switching frequency. Connect an external resistor from this pin to Gnd to set the switching frequency.
6	SS/ $\overline{SD}$	Soft start / shutdown. This pin provides user programmable soft-start function. Connect an external capacitor from this pin to Gnd to set the start up time of the output voltage. The converter can be shutdown by pulling this pin below 0.3V.
7	OCSet	Current limit set point. A resistor from this pin to SW pin will set the current limit threshold.
8	PGood	Power Good status pin. Output is open drain. Connect a pull up resistor from this pin to Vcc. If unused, it can be left open.
9	V <sub>CC</sub>	This pin powers the internal IC and drivers. A minimum of 1uF high frequency capacitor must be connected from this pin to the power ground (PGnd).
10	PGnd	Power Ground. This pin serves as a separated ground for the MOSFET drivers and should be connected to the system's power ground plane.
11	SW	Switch node. This pin is connected to the output inductor.
12	V <sub>IN</sub>	Input voltage connection pin.
13	Boot	Supply voltage for high side driver. Connect a 0.1uF capacitor from this pin to SW.
14	Enable	Enable pin to turn on and off the device.
15	Gnd	Signal ground for internal reference and control circuitry.

## Recommended Operating Conditions

Symbol	Definition	Min	Max	Units
V <sub>in</sub>	Input Voltage	1.0	16	V
V <sub>cc</sub>	Supply Voltage	4.5	5.5	
Boot to SW	Supply Voltage	4.5	5.5	
V <sub>o</sub>	Output Voltage	0.6	0.90*V <sub>in</sub>	
I <sub>o</sub>	Output Current	0	8	A
F <sub>s</sub>	Switching Frequency	225	1650	kHz
T <sub>j</sub>	Junction Temperature	-40	125	°C

## Electrical Specifications

Unless otherwise specified, these specification apply over 4.5V < V<sub>cc</sub> < 5.5V, V<sub>p</sub>=0.6V, V<sub>in</sub>=12V, 0°C < T<sub>j</sub> < 125°C. Typical values are specified at T<sub>a</sub> = 25°C.

Parameter	Symbol	Test Condition	Min	TYP	MAX	Units
<b>Power Loss</b>						
Power Loss	P <sub>loss</sub>	V <sub>cc</sub> =5V, V <sub>in</sub> =12V, V <sub>o</sub> =0.75V, I <sub>o</sub> =8A, F <sub>s</sub> =400kHz, L=0.6uH, <i>Note4</i>		1.28		W
<b>MOSFET R<sub>ds(on)</sub></b>						
Top Switch	R <sub>ds(on)_Top</sub>	V <sub>Boot</sub> -V <sub>sw</sub> =5V, I <sub>D</sub> =10A, T <sub>J</sub> =25°C		17.8	26.5	mΩ
Bottom Switch	R <sub>ds(on)_Bot</sub>	V <sub>cc</sub> =5V, I <sub>D</sub> =10A, T <sub>J</sub> =25°C		8.5	10.7	
<b>Supply Current</b>						
V <sub>cc</sub> Supply Current (Standby)	I <sub>cc(Standby)</sub>	SS=0V, No Switching, Enable low			500	μA
V <sub>cc</sub> Supply Current (Dyn)	I <sub>cc(Dyn)</sub>	SS=3V, V <sub>cc</sub> =5V, F <sub>s</sub> =500kHz Enable high		12		mA
<b>Under Voltage Lockout</b>						
V <sub>cc</sub> -Start-Threshold	V <sub>cc_UVLO_Start</sub>	V <sub>cc</sub> Rising Trip Level	3.95	4.15	4.35	V
V <sub>cc</sub> -Stop-Threshold	V <sub>cc_UVLO_Stop</sub>	V <sub>cc</sub> Falling Trip Level	3.65	3.85	4.05	
Enable-Start-Threshold	Enable_UVLO_Start	Supply ramping up	1.14	1.2	1.36	
Enable-Stop-Threshold	Enable_UVLO_Stop	Supply ramping down	0.9	1.0	1.06	
Enable leakage current	I <sub>en</sub>	Enable=3.3V			15	μA

### Electrical Specifications (continued)

Unless otherwise specified, these specification apply over  $4.5V < V_{cc} < 5.5V$ ,  $V_p = 0.6V$ ,  $V_{in} = 12V$ ,  $0^\circ C < T_j < 125^\circ C$ . Typical values are specified at  $T_a = 25^\circ C$ .

Parameter	Symbol	Test Condition	Min	TYP	MAX	Units
<b>Oscillator</b>						
Rt Voltage			0.665	0.7	0.735	V
Frequency	$F_s$	Rt=59K	225	250	275	kHz
		Rt=28.7K	450	500	550	
		Rt=9.31K, <i>Note4</i>	1350	1500	1650	
Ramp Amplitude	Vramp	<i>Note4</i>	1.8			Vp-p
Ramp Offset	Ramp (os)	<i>Note4</i>		0.6		V
Min Pulse Width	Dmin(ctrl)	<i>Note4</i>		50		ns
Fixed Off Time		<i>Note4</i>		130	200	
Max Duty Cycle	Dmax	Fs=250kHz	92			%
<b>Error Amplifier</b>						
Input Offset Voltage	Vos	Vfb-Vp Vp=0.6V	-5	0	+5	mV
Input Bias Current	IFb(E/A)		-1		+1	$\mu A$
Input Bias Current	IVp(E/A)		-1		+1	
Sink Current	Isink(E/A)		0.40	0.85	1.2	mA
Source Current	Isource(E/A)		8	10	13	
Slew Rate	SR	<i>Note4</i>	7	12	20	V/ $\mu s$
Gain-Bandwidth Product	GBWP	<i>Note4</i>	20	30	40	MHz
DC Gain	Gain	<i>Note4</i>	100	110	120	dB
Maximum Voltage	Vmax(E/A)	Vcc=4.5V	3.4	3.5	3.75	V
Minimum Voltage	Vmin(E/A)			120	220	mV
Common Mode Voltage		<i>Note4</i>	0		1	V
<b>Soft Start/SD</b>						
Soft Start Current	ISS	Source	14	20	26	$\mu A$
Soft Start Clamp Voltage	Vss(clamp)		2.7	3.0	3.3	
Shutdown Output Threshold	SD				0.3	V
<b>Over Current Protection</b>						
OCSET Current	I <sub>OCSET</sub>	Fs=250kHz	20.8	23.6	26.4	$\mu A$
		Fs=500kHz	43	48.8	54.6	
		Fs=1500kHz	136	154	172	
OC Comp Offset Voltage	V <sub>OFFSET</sub>	<i>Note4</i>	-10	0	+10	mV
SS off time	SS_Hiccup			4096		Cycles
<b>Bootstrap Diode</b>						
Forward Voltage		I(Boot)=30mA	180	260	470	mV
<b>Deadband</b>						
Deadband time		<i>Note4</i>	5	10	30	ns

### Electrical Specifications (continued)

Unless otherwise specified, these specification apply over  $4.5V < V_{cc} < 5.5V$ ,  $V_p = 0.6V$ ,  $V_{in} = 12V$ ,  $0^\circ C < T_j < 125^\circ C$ . Typical values are specified at  $T_a = 25^\circ C$ .

Parameter	SYM	Test Condition	Min	TYP	MAX	Units
<b>Thermal Shutdown</b>						
Thermal Shutdown		Note4		140		°C
Hysteresis		Note4		20		
<b>Power Good</b>						
Power Good upper Threshold	VPG(upper)	Fb Rising	0.660	0.690	0.720	V
Upper Threshold Delay	VPG(upper)_Dly	Fb Rising		256/Fs		S
Power Good lower Threshold	VPG(lower)	Fb Falling	0.480	0.510	0.540	V
Lower Threshold Delay	VPG(lower)_Dly	Fb Falling		256/Fs		S
Delay Comparator Threshold	PG(Delay)	Relative to charge voltage, SS rising	2	2.1	2.3	V
Delay Comparator Hysteresis	Delay(hys)	Note4	260	300	340	mV
PGood Voltage Low	PG(voltage)	$I_{PGood} = -5mA$			0.5	V
Leakage Current	$I_{leakage}$			0	10	μA
<b>Switch Node</b>						
SW Bias Current	Isw	SW=0V, Enable=0V			6	μA
		SW=0V, Enable=high, SS=3V, Vp=0V, Note4				

**Note3:** Cold temperature performance is guaranteed via correlation using statistical quality control. Not tested in production.

**Note4:** Guaranteed by Design but not tested in production.

**Note5:** Upgrade to industrial/MSL2 level applies from date codes 1141 (marking explained on application note [AN1132](#) page 2). Products with prior date code of 1141 are qualified with MSL3 for Consumer market.

**TYPICAL OPERATING CHARACTERISTICS (-40°C - 125°C)  $F_s = 500 \text{ kHz}$**

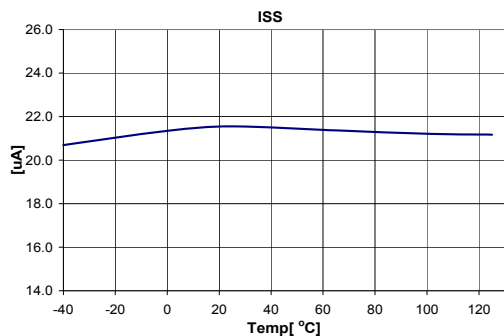
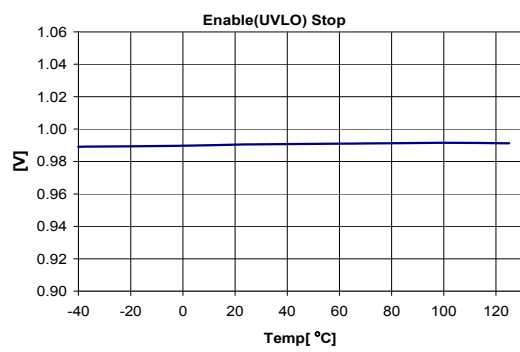
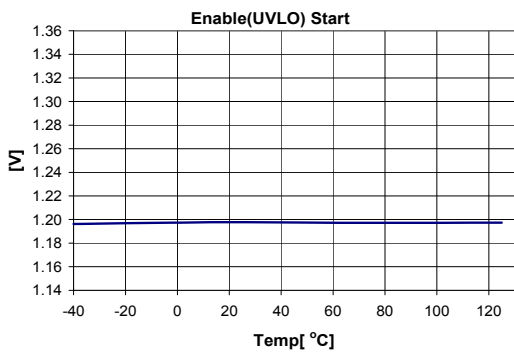
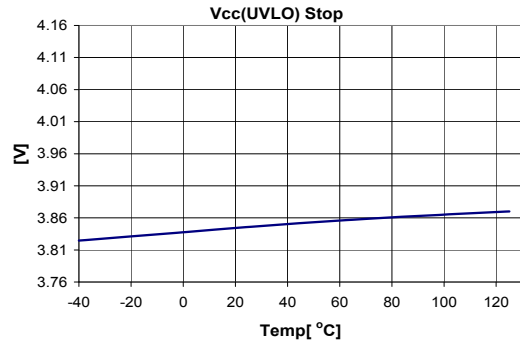
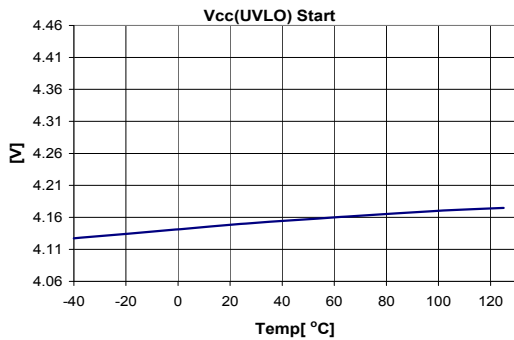
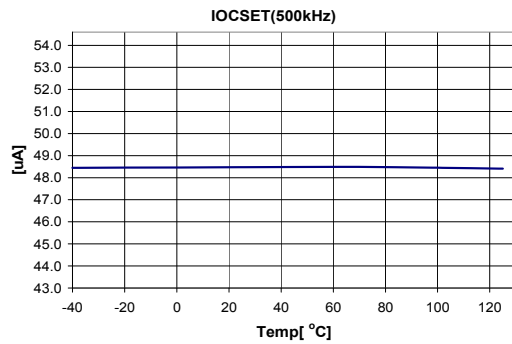
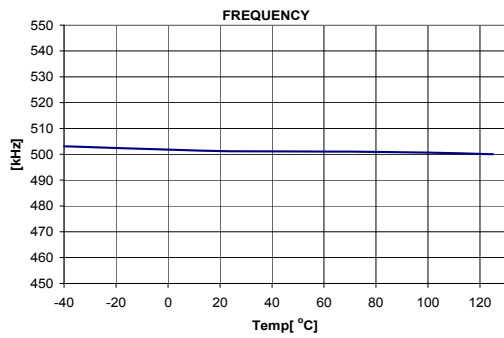
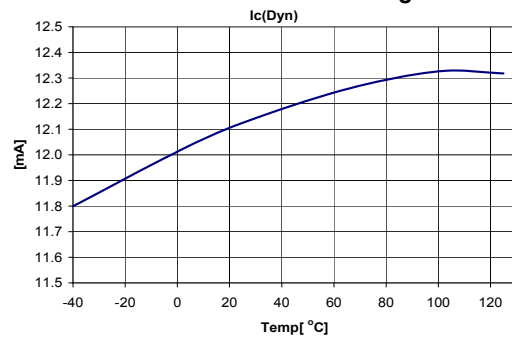
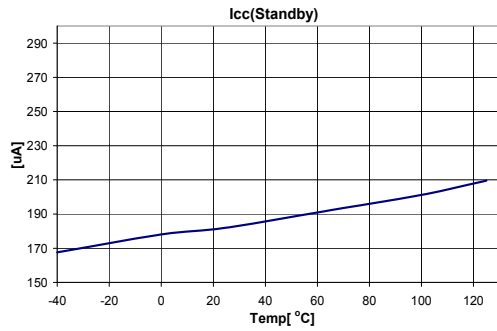

**Rdson of MOSFETs Over Temperature at Vcc=5V**

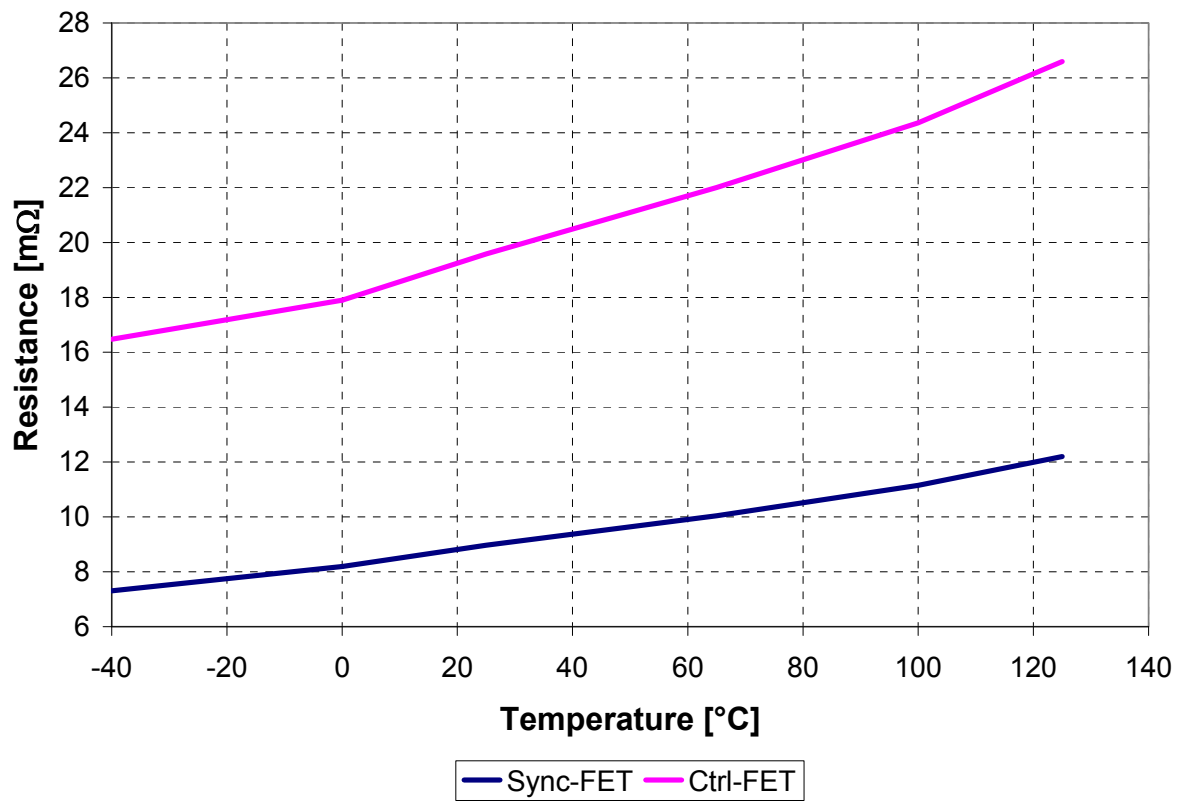

Typical Efficiency and Power Loss Curves

$V_{in}=12V$ ,  $V_o=0.75V$ ,  $V_{cc}=5V$ ,  $I_o=1.0A-8A$ ,  $F_s=400kHz$ ,  $L=0.6\mu H$  (MPL104-0R from Delta), Room Temperature, No Air Flow

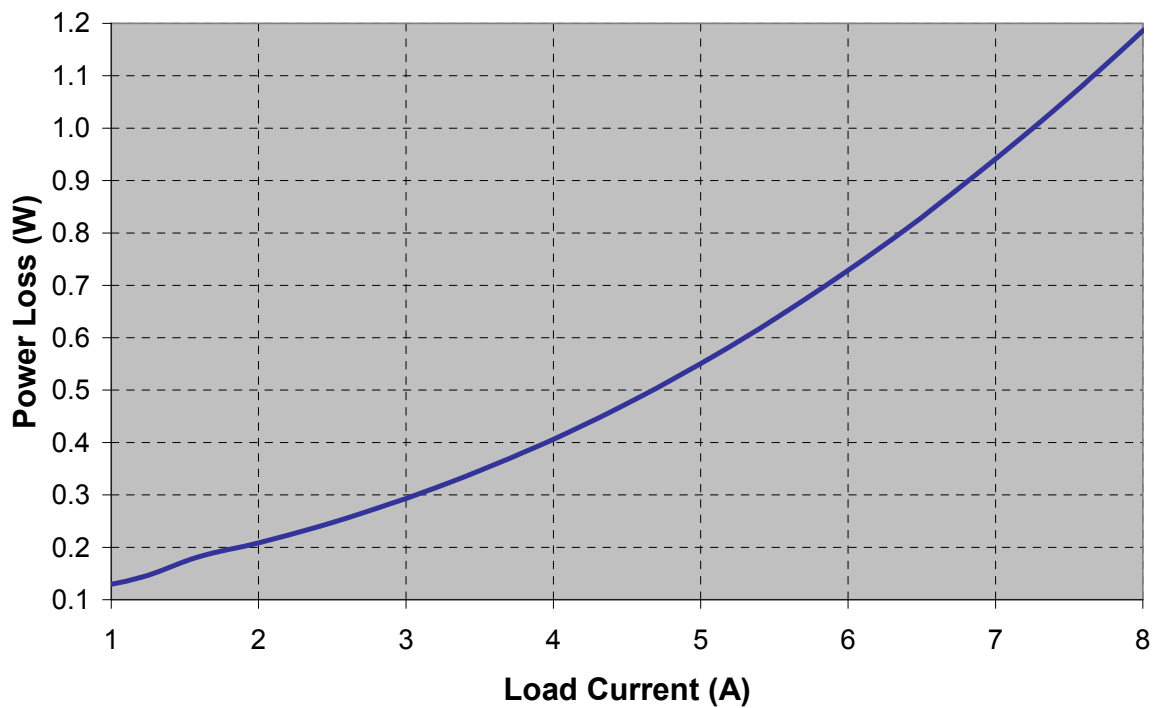
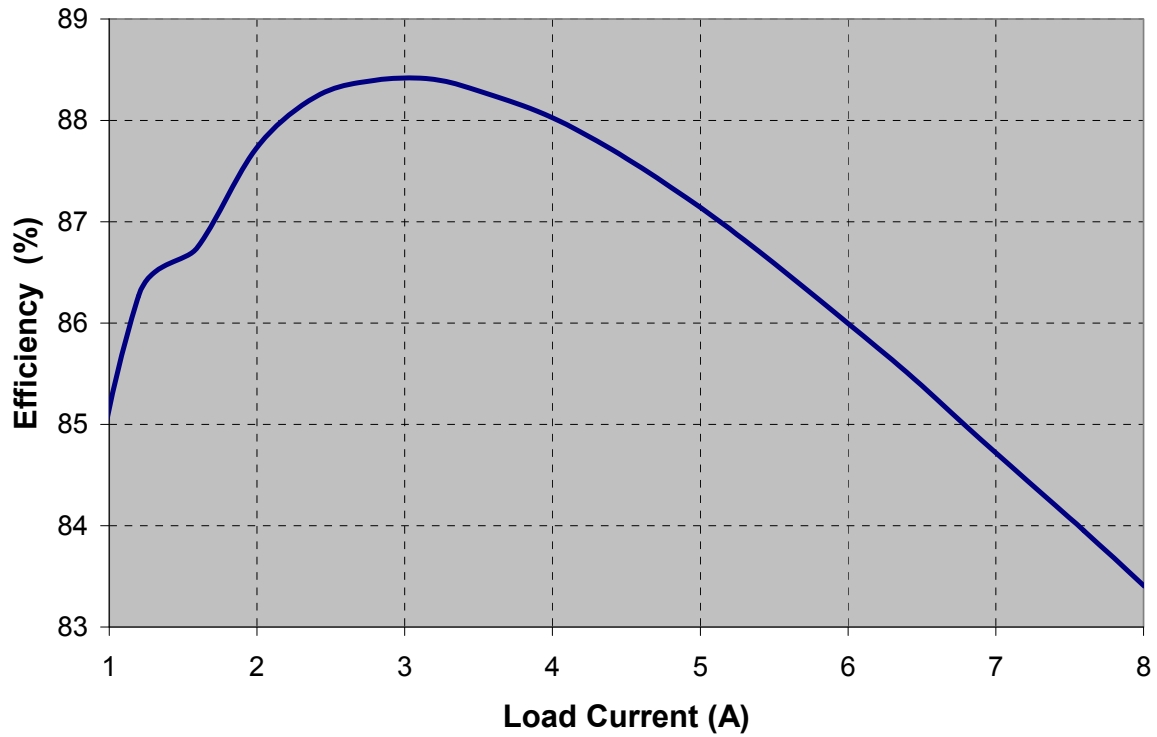

Typical Efficiency and Power Loss Curves  
 $V_{in}=5V$ ,  $V_o=0.75V$ ,  $V_{cc}=5V$ ,  $I_o=1.0A-8A$ ,  $F_s=400kHz$ ,  $L=0.6\mu H$  (MPL104-0R from Delta), Room Temperature, No Air Flow

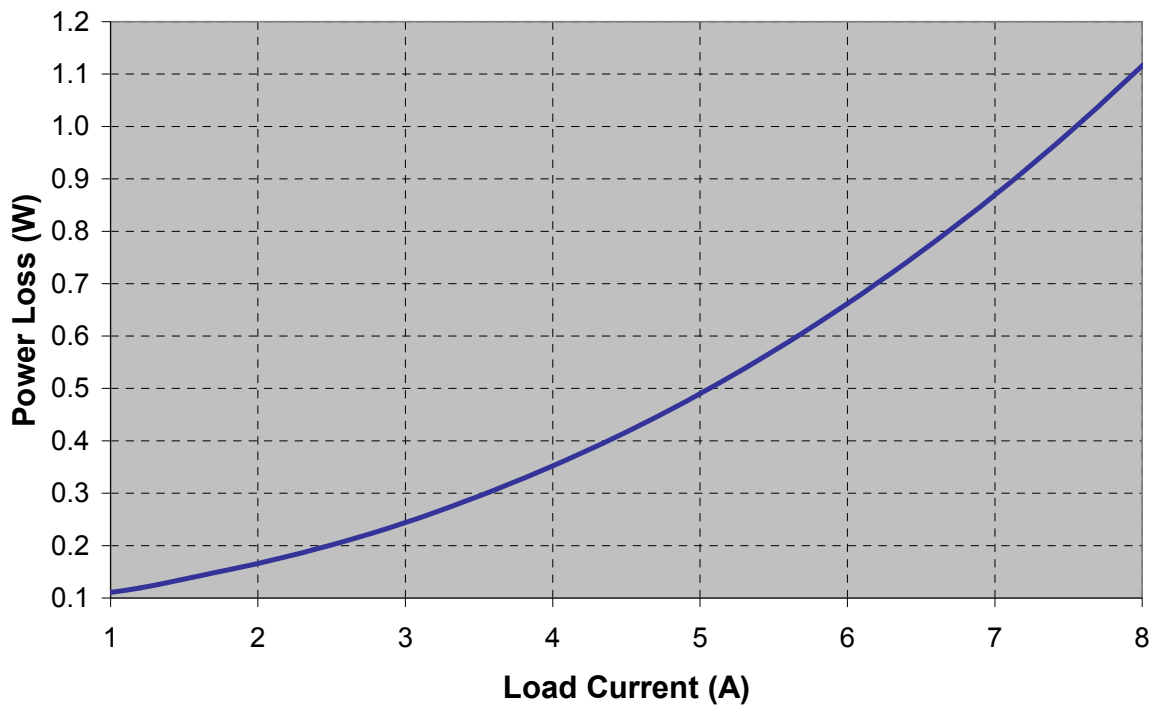
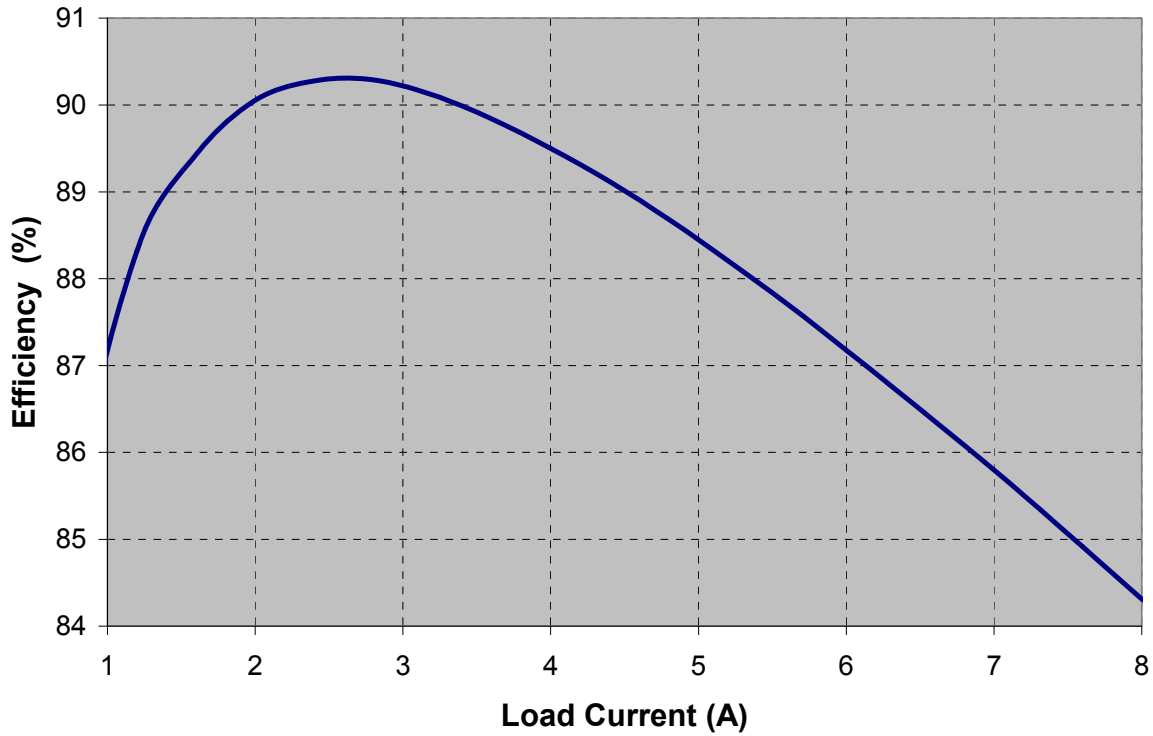

## Circuit Description

### THEORY OF OPERATION

#### Introduction

The IR3831W uses a PWM voltage mode control scheme with external compensation to provide good noise immunity and maximum flexibility in selecting inductor values and capacitor types.

The switching frequency is programmable from 250kHz to 1.5MHz and provides the capability of optimizing the design in terms of size and performance.

IR3831W provides precisely regulated output voltage programmed via two external resistors from 0.6V to 0.9\* $V_{in}$ .

The IR3831W operates with an external bias supply from 4.5V to 5.5V, allowing an extended operating input voltage range from 1.0V to 16V.

The device utilizes the on-resistance of the low side MOSFET as current sense element, this method enhances the converter's efficiency and reduces cost by eliminating the need for external current sense resistor.

IR3831W includes two low  $R_{ds(on)}$  MOSFETs using IR's HEXFET technology. These are specifically designed for high efficiency applications.

#### Under-Voltage Lockout and POR

The under-voltage lockout circuit monitors the input supply  $V_{cc}$  and the Enable input. It assures that the MOSFET driver outputs remain in the off state whenever either of these two signals drop below the set thresholds. Normal operation resumes once  $V_{cc}$  and Enable rise above their thresholds.

The POR (Power On Ready) signal is generated when all these signals reach the valid logic level (see system block diagram). When the POR is asserted the soft start sequence starts (see soft start section).

#### Enable

The Enable features another level of flexibility for start up. The Enable has precise threshold which is internally monitored by Under-Voltage Lockout (UVLO) circuit. Therefore, the IR3831W will turn on only when the voltage at the Enable pin exceeds this threshold, typically, 1.2V.

If the input to the Enable pin is derived from the bus voltage by a suitably programmed resistive divider, it can be ensured that the IR3831W does not turn on until the bus voltage reaches the desired level. Only after the bus voltage reaches or exceeds this level will the voltage at Enable pin exceed its threshold, thus enabling the IR3831W. Therefore, in addition to being a logic input pin to enable the IR3831W, the Enable feature, with its precise threshold, also allows the user to implement an Under-Voltage Lockout for the bus voltage  $V_{in}$ . This is desirable particularly for high output voltage applications, where we might want the IR3831W to be disabled at least until  $V_{in}$  exceeds the desired output voltage level.

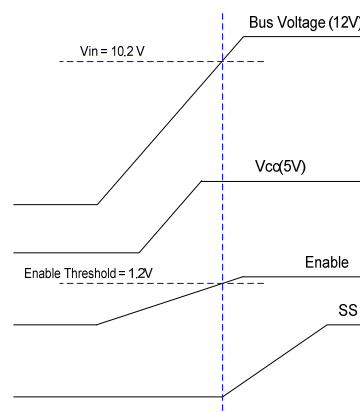

Fig. 3a. Normal Start up, Device turns on when the Bus voltage reaches 10.2V

Figure 3b. shows the recommended start-up sequence for the non-tracking operation of IR3831W, when Enable is used as a logic input.

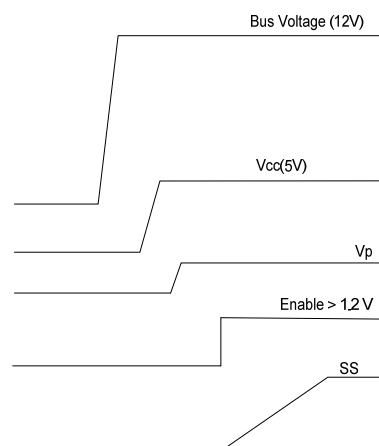

Fig. 3b. Recommended startup sequence, Non-Tracking operation

Figure 3c. shows the recommended startup sequence for tracking operation of IR3831W with Enable used as logic input.

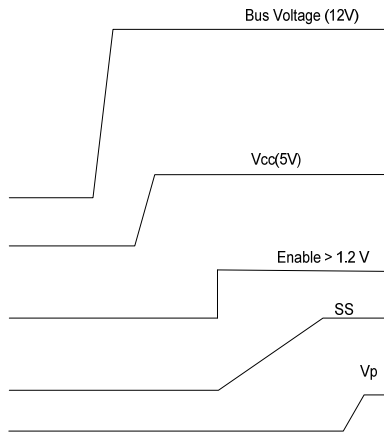

Fig. 3c. Recommended startup sequence, Sequenced operation

**Pre-Bias Startup**

IR3831W is able to start up into pre-charged output, which prevents oscillation and disturbances of the output voltage.

The output starts in asynchronous fashion and keeps the synchronous MOSFET off until the first gate signal for control MOSFET is generated. Figure 4 shows a typical Pre-Bias condition at start up.

The synchronous MOSFET always starts with a narrow pulse width and gradually increases its duty cycle with a step of 25%, 50%, 75% and 100% until it reaches the steady state value. The number of these startup pulses for the synchronous MOSFET is internally programmed. Figure 5 shows a series of 32, 16, 8 startup pulses.

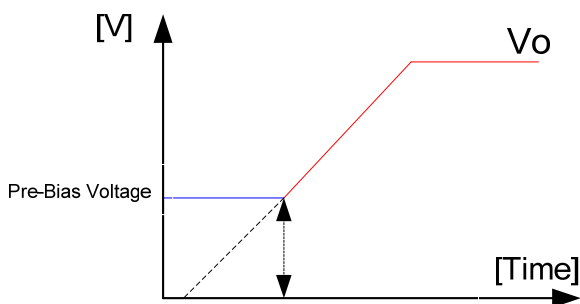

Fig. 4. Pre-Bias startup

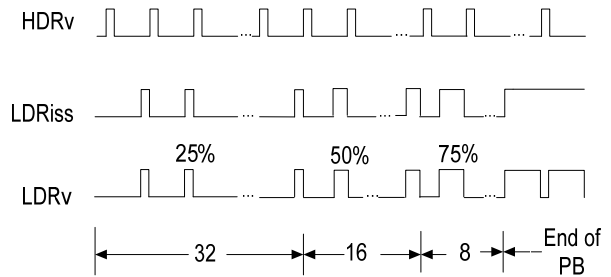

Fig. 5. Pre-Bias startup pulses

**Soft-Start**

The IR3831W has a programmable soft-start to control the output voltage rise and limit the current surge at the start-up. To ensure correct start-up, the soft-start sequence initiates when the Enable and Vcc rise above their UVLO thresholds and generate the Power On Ready (POR) signal. The internal current source (typically 20uA) charges the external capacitor C<sub>SS</sub> linearly from 0V to 3V. Figure 6 shows the waveforms during the soft start.

The start up time can be estimated by:

$$T_{start} = \frac{V_p * C_{SS}}{20\mu A} \text{ ----- (1)}$$

During the soft start the OCP is enabled to protect the device for any short circuit and over current condition.

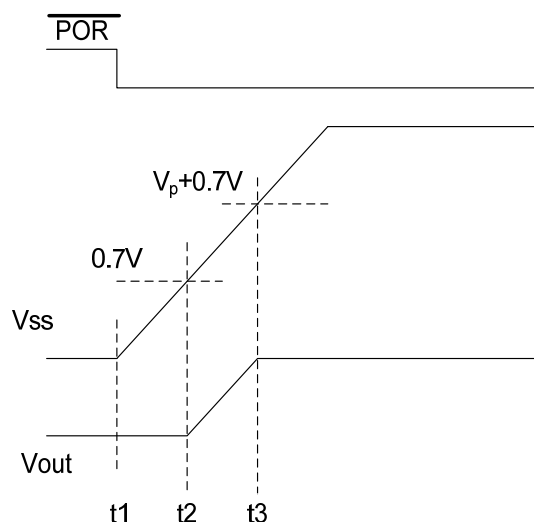

Fig. 6. Theoretical operation waveforms during soft-start

**Operating Frequency**

The switching frequency can be programmed between 250kHz – 1500kHz by connecting an external resistor from R<sub>t</sub> pin to Gnd. Table 1 tabulates the oscillator frequency versus R<sub>t</sub>.

Table 1. Switching Frequency and I<sub>OCSet</sub> vs. External Resistor (R<sub>t</sub>)

R <sub>t</sub> (kΩ)	F <sub>s</sub> (kHz)	I <sub>OCSet</sub> (μA)
47.5	300	29.4
35.7	400	39.2
28.7	500	48.7
23.7	600	59.07
20.5	700	68.2
17.8	800	78.6
15.8	900	88.6
14.3	1000	97.9
12.7	1100	110.2
11.5	1200	121.7
10.7	1300	130.8
9.76	1400	143.4
9.31	1500	150.3

**Shutdown**

The IR3831W can be shutdown by pulling the Enable pin below its 1 V threshold. This will tri-state both, the high side driver as well as the low side driver. Alternatively, the output can be shutdown by pulling the soft-start pin below 0.3V. Normal operation is resumed by cycling the voltage at the Soft Start pin.

**Over-Current Protection**

The over current protection is performed by sensing current through the R<sub>DS(on)</sub> of low side MOSFET. This method enhances the converter’s efficiency and reduces cost by eliminating a current sense resistor. As shown in figure 7, an external resistor (R<sub>OCSet</sub>) is connected between OCSet pin and the switch node (SW) which sets the current limit set point.

An internal current source sources current (I<sub>OCSet</sub>) out of the OCSet pin. This current is a function of the switching frequency and hence, of R<sub>t</sub>.

$$I_{OCSet} (\mu A) = \frac{1400}{R_t (k\Omega)} \dots\dots\dots(2)$$

Table 1. shows I<sub>OCSet</sub> at different switching frequencies. The internal current source develops a voltage across R<sub>OCSet</sub>. When the low side MOSFET is turned on, the inductor current flows through the Q2 and results in a voltage at OCSet which is given by:

$$V_{OCSet} = (I_{OCSet} * R_{OCSet}) - (R_{DS(on)} * I_L) \dots\dots\dots(3)$$

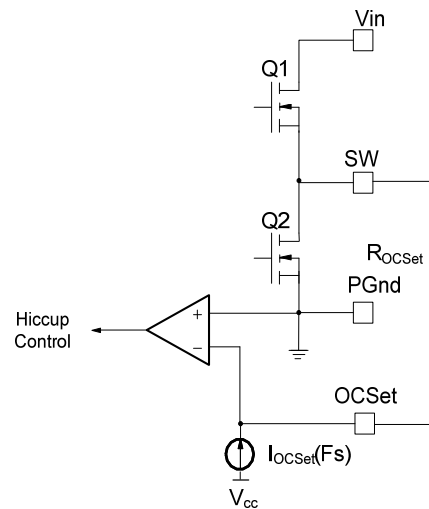

Fig. 7. Connection of over current sensing resistor

An over current is detected if the OCSet pin goes below ground. Hence, at the current limit threshold, V<sub>OCSet</sub>=0. Then, for a current limit setting I<sub>Limit</sub>, R<sub>OCSet</sub> is calculated as follows:

$$R_{OCSet} = \frac{R_{DS(on)} * I_{Limit}}{I_{OCSet}} \dots\dots\dots(4)$$

An overcurrent detection trips the OCP comparator, latches OCP signal and cycles the soft start function in hiccup mode.

The hiccup is performed by shorting the soft-start capacitor to ground and counting the number of switching cycles. The Soft Start pin is held low until 4096 cycles have been completed. The OCP signal resets and the converter recovers. After every soft start cycle, the converter stays in this mode until the overload or short circuit is removed.

The OCP circuit starts sampling current typically 160 ns after the low gate drive rises to about 3V. This delay functions to filter out switching noise.

**Thermal Shutdown**

Temperature sensing is provided inside IR3831W. The trip threshold is typically set to 140°C. When trip threshold is exceeded, thermal shutdown turns off both MOSFETs and discharges the soft start capacitor.

Automatic restart is initiated when the sensed temperature drops within the operating range. There is a 20°C hysteresis in the thermal shutdown threshold.

**Power Good Output**

The IC continually monitors the output voltage via Feedback (Fb pin). The Power Good signal is flagged when the Fb pin voltage is above 0.5V and between 85% to 115 % of Vp. This pin is open drain and it needs to be externally pulled high. High state indicates that output is in regulation. Fig. 8a shows the PGood timing diagram for non-tracking operation. In this case, during startup, PGood goes high after the SS voltage reaches 2.1V if the Fb voltage is within the PGood comparator window. Fig. 8a. and Fig 8b. also show a 256 cycle delay between the Fb voltage entering within the thresholds defined by the PGood window and PGood going high.

**TIMING DIAGRAM OF PGOOD FUNCTION**

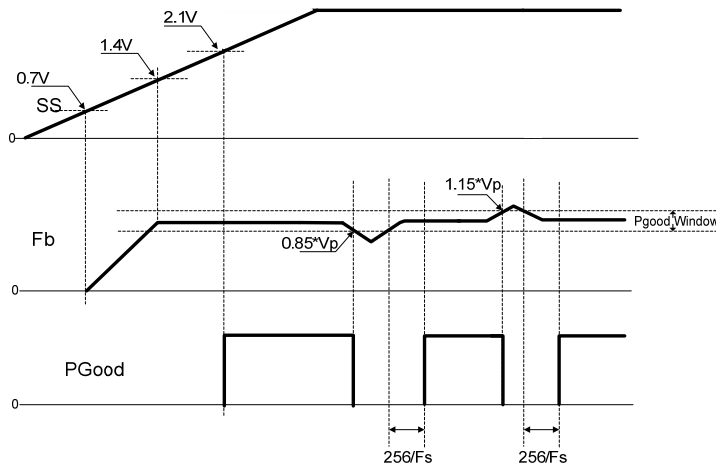

Fig.8a IR3831W Non-Tracking Operation

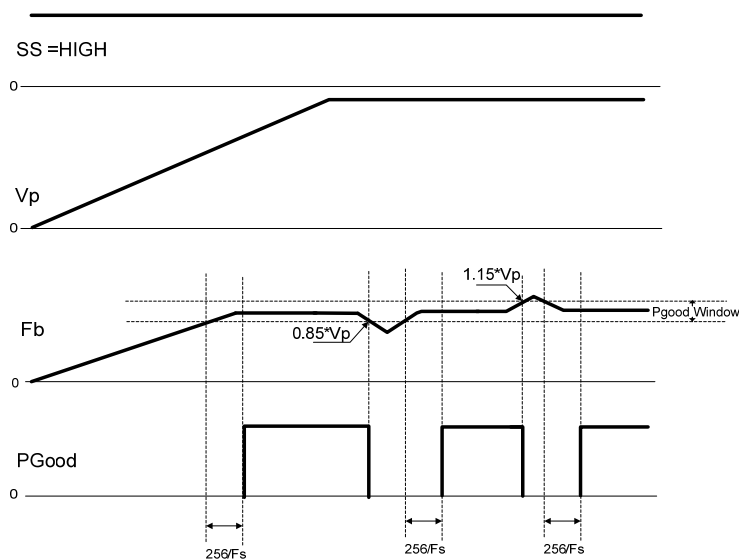

Fig.8b IR3831W Tracking Operation

### Minimum on time Considerations

The minimum ON time is the shortest amount of time for which the Control FET may be reliably turned on, and this depends on the internal timing delays. For the IR3831W, the typical minimum on-time is specified as 50 ns.

Any design or application using the IR3831W must ensure operation with a pulse width that is higher than this minimum on-time and preferably higher than 100 ns. This is necessary for the circuit to operate without jitter and pulse-skipping, which can cause high inductor current ripple and high output voltage ripple.

$$t_{on} = \frac{D}{F_s}$$

$$= \frac{V_{out}}{V_{in} \times F_s}$$

In any application that uses the IR3831W, the following condition must be satisfied:

$$t_{on(min)} \leq t_{on}$$

$$\therefore t_{on(min)} \leq \frac{V_{out}}{V_{in} \times F_s}$$

$$\therefore V_{in} \times F_s \leq \frac{V_{out}}{t_{on(min)}}$$

The minimum output voltage for the IR3831W is limited to  $V_{out(min)} = 0.6 \text{ V}$ .

$$\therefore V_{in} \times F_s \leq \frac{V_{out(min)}}{t_{on(min)}}$$

$$\therefore V_{in} \times F_s \leq \frac{0.6 \text{ V}}{100 \text{ ns}} = 6 \times 10^6 \text{ V/s}$$

Furthermore, for the IR3831W, especially for active bus termination applications, it is strongly recommended to use a switching frequency of 400 kHz to obtain clean and jitter free operation in sourcing as well as sinking modes. Therefore, the maximum input voltage that may be stepped down to 0.6V at 400 kHz without jitter or pulse skipping is 15 V.

### Maximum Duty Ratio Considerations

A fixed off-time of 200 ns maximum is specified for the IR3831W. This provides an upper limit on the operating duty ratio at any given switching frequency. It is clear, that higher the switching frequency, the lower is the maximum duty ratio at which the IR3831W can operate. To allow a margin of 50ns, the maximum operating duty ratio in any application using the IR3831W should still accommodate about 250 ns off-time. Fig 9. shows a plot of the maximum duty ratio v/s the switching frequency, with 250 ns off-time.

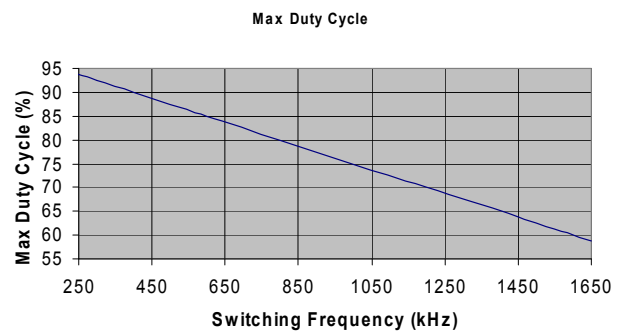

Fig. 9. Maximum duty cycle v/s switching frequency.

**Application Information**

**Design Example:**

The following example is a typical application for IR3831W. The application circuit is shown on page 22.

- $V_{in} = 12\text{ V (13.2V max)}$
- $V_o = 0.75\text{ V}$
- $I_o = 8\text{ A}$
- $\Delta V_o \leq 22.5\text{ mV}$
- $F_s = 400\text{ kHz}$

**Enabling the IR3831W**

As explained earlier, the precise threshold of the Enable lends itself well to implementation of a UVLO for the Bus Voltage.

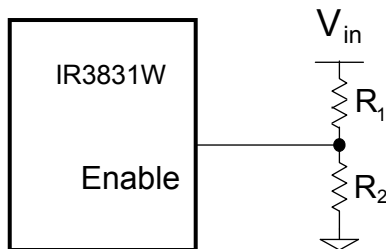

For a typical Enable threshold of  $V_{EN} = 1.2\text{ V}$

$$V_{in(min)} * \frac{R_2}{R_1 + R_2} = V_{EN} = 1.2 \dots\dots\dots (5)$$

$$R_2 = R_1 \frac{V_{EN}}{V_{in(min)} - V_{EN}} \dots\dots\dots (6)$$

For a  $V_{in(min)} = 10.2\text{ V}$ ,  $R_1 = 49.9\text{ K}$  and  $R_2 = 7.5\text{ k}\Omega$  is a good choice.

**Programming the frequency**

For  $F_s = 400\text{ kHz}$ , select  $R_t = 35.7\text{ k}\Omega$ , using Table. 1.

**Output Voltage Programming**

Output voltage is programmed by the tracking reference voltage at Vp and external voltage divider. The divider is ratioed such that the voltage at the Fb pin is equal to the voltage at the Vp pin when the output is at its desired value. The output voltage is defined by using the following equation:

$$V_o = V_p * \left(1 + \frac{R_8}{R_9}\right) \dots\dots\dots (7)$$

When an external resistor divider is connected to the output as shown in figure 10.

Equation (5) can be rewritten as:

$$R_9 = R_8 * \left(\frac{V_p}{V_o - V_p}\right) \dots\dots\dots (8)$$

For low voltage applications, such as this design, it is often advisable to eliminate the bias resistor R9 from Fb to ground. For the calculated value of R8 see feedback compensation section.

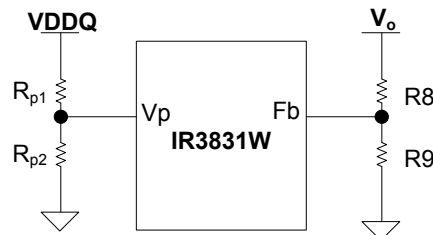

Fig. 10. Typical application of the IR3831W for programming the output voltage

Further, the tracking reference Vp may be itself derived from some master reference by means of a resistive divider as shown in Fig. 9. This is common in active bus termination circuits such as Voltage Tracking Termination (VTT) where the tracking reference Vp may be obtained as half of the master reference VDDQ which forms the input to one or more memory banks.

- In this design,
- $VDDQ = 1.5\text{ V}$
- $R_{p1} = R_{p2} = 1.5\text{ k}\Omega$
- $V_p = 0.75\text{ V}$

It is desirable to use a small capacitor such as 10nF in parallel with R<sub>p2</sub> to bypass high frequency noise on Vp pin.

**Soft-Start Programming**

The soft-start timing can be programmed by selecting the soft-start capacitance value. From (1), for a desired start-up time of the converter, the soft start capacitor can be calculated by using:

$$C_{SS}(\mu\text{F}) = T_{start}(\text{ms}) \times 0.02857 \dots\dots\dots (9)$$

Where  $T_{start}$  is the desired start-up time (ms). For tracking applications the output is generally required to track Vp even at start-up. Hence, it is necessary to ensure that the SS pin is already up to 3 V before the tracking reference signal is applied to the Vp pin. This can be done by choosing a small value for the soft-start capacitor to ensure that the voltage at the SS pin rises to 3 V quickly. A 0.022 uF capacitor is chosen for this purpose.

**Bootstrap Capacitor Selection**

To drive the Control FET, it is necessary to supply a gate voltage at least 4V greater than the voltage at the SW pin, which is connected the source of the Control FET . This is achieved by using a bootstrap configuration, which comprises the internal bootstrap diode and an external bootstrap capacitor (C6), as shown in Fig. 11. The operation of the circuit is as follows: When the lower MOSFET is turned on, the capacitor node connected to SW is pulled down to ground. The capacitor charges towards  $V_{cc}$  through the internal bootstrap diode, which has a forward voltage drop  $V_D$ . The voltage  $V_c$  across the bootstrap capacitor C6 is approximately given as

$$V_c \cong V_{cc} - V_D \dots\dots\dots(10)$$

When the upper MOSFET turns on in the next cycle, the capacitor node connected to SW rises to the bus voltage  $V_{in}$ . However, if the value of C6 is appropriately chosen, the voltage  $V_c$  across C6 remains approximately unchanged and the voltage at the Boot pin becomes

$$V_{Boot} \cong V_{in} + V_{cc} - V_D \dots\dots\dots(11)$$

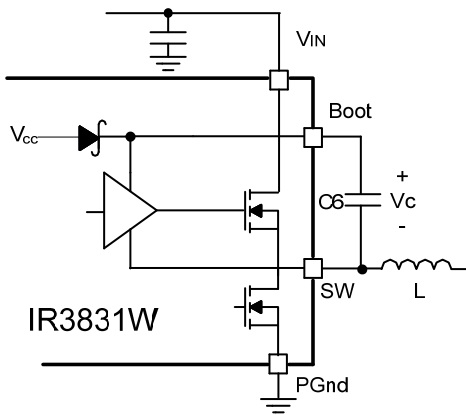

Fig. 11. Bootstrap circuit to generate  $V_c$  voltage

A bootstrap capacitor of value 0.1uF is suitable for most applications.

**Input Capacitor Selection**

The ripple current generated during the on time of the upper MOSFET should be provided by the input capacitor. The RMS value of this ripple is expressed by:

$$I_{RMS} = I_o * \sqrt{D*(1-D)} \dots\dots\dots(12)$$

$$D = \frac{V_o}{V_{in}} \dots\dots\dots(13)$$

Where:

$D$  is the Duty Cycle

$I_{RMS}$  is the RMS value of the input capacitor current.

$I_o$  is the output current.

For  $I_o=8$  A and  $D = 0.0625$ , the  $I_{RMS} = 1.94$  A

Ceramic capacitors are recommended due to their peak current capabilities. They also feature low ESR and ESL at higher frequency which enables better efficiency. For this application, it is advisable to have 3x10uF 16V ceramic capacitors ECJ-3YX1C106K from Panasonic. In addition to these, although not mandatory, a 330uF 25V SMD capacitor EEV-FK1E331P from Panasonic may be used as a bulk capacitor, and is recommended if the input power supply is not located close to the converter.

**Inductor Selection**

The inductor is selected based on output power, operating frequency and efficiency requirements. A low inductor value results in a smaller size and faster response to a load transient but poor efficiency and high output noise due to large ripple current. Generally, the selection of the inductor value can be reduced to the desired maximum ripple current in the inductor ( $\Delta i$ ). The optimum point is usually found between 20% and 50% ripple of the output current.

For the buck converter, the inductor value for the desired operating ripple current can be determined using the following relation:

$$V_{in} - V_o = L * \frac{\Delta i}{\Delta t}; \quad \Delta t = D * \frac{1}{F_s} \dots\dots\dots(14)$$

$$L = (V_{in} - V_o) * \frac{V_o}{V_{in} * \Delta i * F_s}$$

Where:  $V_{in}$  = Maximum input voltage

$V_o$  = Output Voltage

$\Delta i$  = Inductor ripple current

$F_s$  = Switching frequency

$\Delta t$  = Turn on time

$D$  = Duty cycle

If  $\Delta i \approx 35\%(I_o)$ , then the output inductor is calculated to be 0.63uH. Select  $L=0.6 \mu H$ .

The MPL104-0R6 from Delta provides a compact, low profile inductor suitable for this application.

**Output Capacitor Selection**

The voltage ripple and transient requirements determine the output capacitors type and values. The criteria is normally based on the value of the Effective Series Resistance (ESR). However the actual capacitance value and the Equivalent Series Inductance (ESL) are other contributing components. These components can be described as

$$\Delta V_o = \Delta V_{o(ESR)} + \Delta V_{o(ESL)} + \Delta V_{o(C)}$$

$$\Delta V_{o(ESR)} = \Delta I_L * ESR$$

$$\Delta V_{o(ESL)} = \left( \frac{V_{in} - V_o}{L} \right) * ESL$$

$$\Delta V_{o(C)} = \frac{\Delta I_L}{8 * C_o * F_s} \dots\dots\dots (15)$$

$\Delta V_o$  = Output voltage ripple

$\Delta I_L$  = Inductor ripple current

Since the output capacitor has a major role in the overall performance of the converter and determines the result of transient response, selection of the capacitor is critical. The IR3831W can perform well with all types of capacitors.

As a rule, the capacitor must have low enough ESR to meet output ripple and load transient requirements.

The goal for this design is to meet the voltage ripple requirement in the smallest possible capacitor size. Therefore it is advisable to select ceramic capacitors due to their low ESR and ESL and small size. Eight of the Panasonic ECJ-2FB0J226ML (22uF, 6.3V, 3mOhm) capacitors is a good choice.

**Feedback Compensation**

The IR3831W is a voltage mode controller. The control loop is a single voltage feedback path including error amplifier and error comparator. To achieve fast transient response and accurate output regulation, a compensation circuit is necessary. The goal of the compensation network is to provide a closed-loop transfer function with the highest 0 dB crossing frequency and adequate phase margin (greater than 45°).

The output LC filter introduces a double pole, -40dB/decade gain slope above its corner resonant frequency, and a total phase lag of 180° (see figure 12). The resonant frequency of the LC filter is expressed as follows:

$$F_{LC} = \frac{1}{2 * \pi * \sqrt{L_o * C_o}} \dots\dots\dots (16)$$

Figure 12 shows gain and phase of the LC filter. Since we already have 180° phase shift from the output filter alone, the system runs the risk of being unstable.

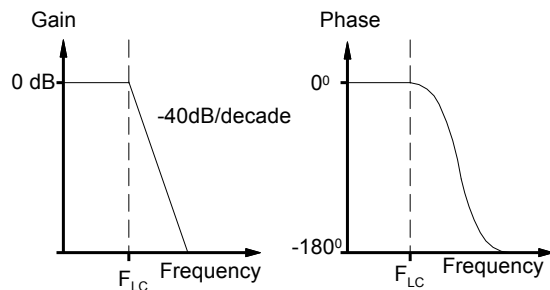

Fig. 12. Gain and Phase of LC filter

The IR3831W uses a voltage-type error amplifier with high-gain (110dB) and wide-bandwidth. The output of the error amplifier is available for DC gain control and AC phase compensation.

The error amplifier can be compensated either in type II or type III compensation.

Local feedback with Type II compensation is shown in Fig. 13.

This method requires that the output capacitor should have enough ESR to satisfy stability requirements. In general the output capacitor's ESR generates a zero typically at 5kHz to 50kHz which is essential for an acceptable phase margin.

The ESR zero of the output capacitor is expressed as follows:

$$F_{ESR} = \frac{1}{2 * \pi * ESR * C_o} \dots\dots\dots (17)$$

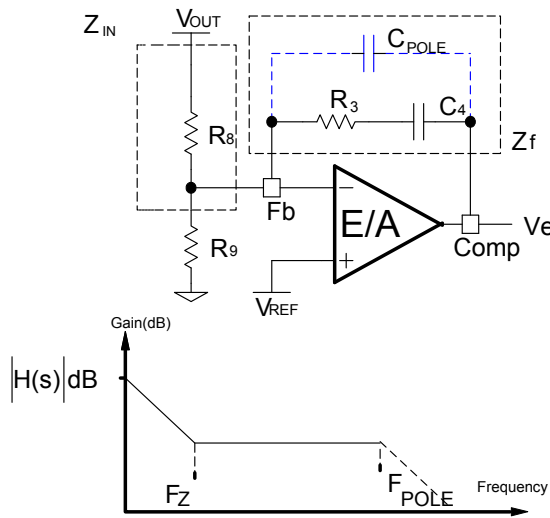

Fig. 13. Type II compensation network and its asymptotic gain plot

The transfer function ( $V_e/V_o$ ) is given by:

$$\frac{V_e}{V_o} = H(s) = -\frac{Z_f}{Z_{IN}} = -\frac{1 + sR_3C_4}{sR_8C_4} \dots (18)$$

The (s) indicates that the transfer function varies as a function of frequency. This configuration introduces a gain and zero, expressed by:

$$|H(s)| = \frac{R_3}{R_8} \dots (19)$$

$$F_z = \frac{1}{2\pi * R_3 * C_4} \dots (20)$$

First select the desired zero-crossover frequency ( $F_o$ ):

$$F_o > F_{ESR} \text{ and } F_o \leq (1/5 \sim 1/10) * F_s$$

Use the following equation to calculate R3:

$$R_3 = \frac{V_{osc} * F_o * F_{ESR} * R_8}{V_{in} * F_{LC}^2} \dots (21)$$

Where:

- $V_{in}$  = Maximum Input Voltage
- $V_{osc}$  = Oscillator Ramp Voltage
- $F_o$  = Crossover Frequency
- $F_{ESR}$  = Zero Frequency of the Output Capacitor
- $F_{LC}$  = Resonant Frequency of the Output Filter
- $R_8$  = Feedback Resistor

To cancel one of the LC filter poles, place the zero before the LC filter resonant frequency pole:

$$F_z = 75\% F_{LC}$$

$$F_z = 0.75 * \frac{1}{2\pi * \sqrt{L_o} * C_o} \dots (22)$$

Use equations (20), (21) and (22) to calculate C4.

One more capacitor is sometimes added in parallel with C4 and R3. This introduces one more pole which is mainly used to suppress the switching noise.

The additional pole is given by:

$$F_p = \frac{1}{2\pi * R_3 * \frac{C_4 * C_{POLE}}{C_4 + C_{POLE}}} \dots (23)$$

The pole sets to one half of the switching frequency which results in the capacitor  $C_{POLE}$ :

$$C_{POLE} = \frac{1}{\pi * R_3 * F_s - \frac{1}{C_4}} \cong \frac{1}{\pi * R_3 * F_s} \dots (24)$$

For a general solution for unconditional stability for any type of output capacitors, and a wide range of ESR values, we should implement local feedback with a type III compensation network. The typically used compensation network for voltage-mode controller is shown in figure 14.

Again, the transfer function is given by:

$$\frac{V_e}{V_o} = H(s) = -\frac{Z_f}{Z_{IN}}$$

By replacing  $Z_{in}$  and  $Z_f$  according to figure 14, the transfer function can be expressed as:

$$H(s) = -\frac{(1 + sR_3C_4)[1 + sC_7(R_8 + R_{10})]}{sR_8(C_4 + C_3) \left[ 1 + sR_3 \left( \frac{C_4 * C_3}{C_4 + C_3} \right) \right] (1 + sR_{10}C_7)} \dots (25)$$

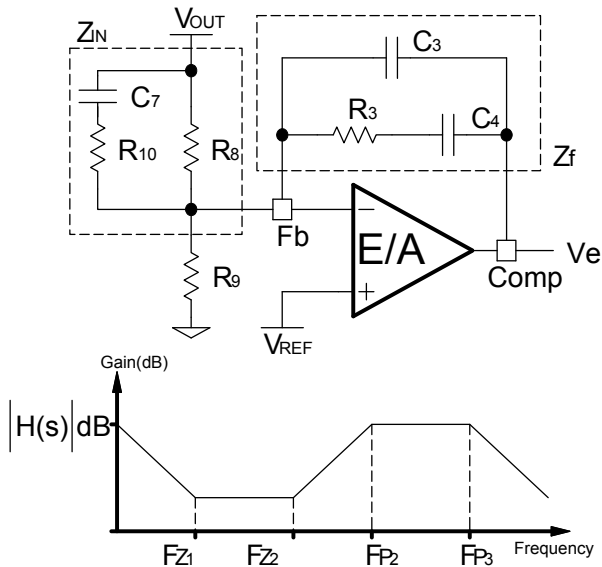

Fig.14. Type III Compensation network and its asymptotic gain plot

The compensation network has three poles and two zeros and they are expressed as follows:

$$F_{P1} = 0 \dots \dots \dots (26)$$

$$F_{P2} = \frac{1}{2\pi * R_{10} * C_7} \dots \dots \dots (27)$$

$$F_{P3} = \frac{1}{2\pi * R_3 * \left( \frac{C_4 * C_3}{C_4 + C_3} \right)} \cong \frac{1}{2\pi * R_3 * C_3} \dots \dots \dots (28)$$

$$F_{Z1} = \frac{1}{2\pi * R_3 * C_4} \dots \dots \dots (29)$$

$$F_{Z2} = \frac{1}{2\pi * C_7 * (R_8 + R_{10})} \cong \frac{1}{2\pi * C_7 * R_8} \dots \dots \dots (30)$$

Cross over frequency is expressed as:

$$F_o = R_3 * C_7 * \frac{V_{in}}{V_{osc}} * \frac{1}{2\pi * L_o * C_o} \dots \dots \dots (31)$$

Based on the frequency of the zero generated by the output capacitor and its ESR, relative to crossover frequency, the compensation type can be different. The table below shows the compensation types and location of the crossover frequency.

Compensator Type	$F_{ESR}$ vs $F_o$	Output Capacitor
Type II	$F_{LC} < F_{ESR} < F_o < F_s/2$	Electrolytic Tantalum
Type III	$F_{LC} < F_o < F_{ESR}$	Tantalum Ceramic

The higher the crossover frequency, the potentially faster the load transient response. However, the crossover frequency should be low enough to allow attenuation of switching noise. Typically, the control loop bandwidth or crossover frequency is selected such that

$$F_o \leq (1/5 \sim 1/10) * F_s$$

The DC gain should be large enough to provide high DC-regulation accuracy. The phase margin should be greater than 45° for overall stability.

For this design we have:

- $V_{in} = 12V$
- $V_o = 0.75V$
- $V_{osc} = 1.8V$
- $V_p = 0.75V$
- $L_o = 0.6 \mu H$
- $C_o = 8x22\mu F, ESR = 3m\Omega$  each

It must be noted here that the value of the capacitance used in the compensator design must be the small signal value. For instance, the small signal capacitance of the 22uF capacitor used in this design is 12uF at 0.75 VDC bias and 400 kHz frequency. It is this value that must be used for all computations related to the compensation. The small signal value may be obtained from the manufacturer's datasheets, design tools or SPICE models. Alternatively, they may also be inferred from measuring the power stage transfer function of the converter and measuring the double pole frequency  $F_{LC}$  and using equation (16) to compute the small signal  $C_o$ .

These result to:

- $F_{LC} = 20.97 \text{ kHz}$
- $F_{ESR} = 4.4 \text{ MHz}$
- $F_{s/2} = 200 \text{ kHz}$

Select crossover frequency:  $F_o = 60 \text{ kHz}$

Since  $F_{LC} < F_o < F_s/2 < F_{ESR}$ , Type III is selected to place the pole and zeros.

Detailed calculation of compensation TypeIII

Desired Phase Margin  $\Theta = 70^\circ$

$$F_{Z2} = F_o \sqrt{\frac{1 - \sin \Theta}{1 + \sin \Theta}} = 10.58 \text{ kHz}$$

$$F_{P2} = F_o \sqrt{\frac{1 + \sin \Theta}{1 - \sin \Theta}} = 340.28 \text{ kHz}$$

Select  $F_{Z1} = 0.5 * F_{Z2} = 5.29 \text{ kHz}$  and

$$F_{P3} = 0.5 * F_s = 200 \text{ kHz}$$

Select  $C_7 = 2.2 \text{ nF}$

Calculate  $R_3$ ,  $C_3$  and  $C_4$  :

$$R_3 = \frac{2\pi * F_o * L_o * C_o * V_{osc}}{C_7 * V_{in}}; R_3 = 1.48 \text{ k}\Omega$$

Select  $R_3 = 1.47 \text{ k}\Omega$

$$C_4 = \frac{1}{2\pi * F_{Z1} * R_3}; C_4 = 20.47 \text{ nF, Select } C_4 = 22 \text{ nF}$$

$$C_3 = \frac{1}{2\pi * F_{P3} * R_3}; C_3 = 541.34 \text{ pF, Select } C_3 = 560 \text{ pF}$$

Calculate  $R_{10}$ ,  $R_8$  and  $R_9$  :

$$R_{10} = \frac{1}{2\pi * C_7 * F_{P2}}; R_{10} = 215 \Omega \text{ Select } R_{10} = 210 \Omega$$

$$R_8 = \frac{1}{2\pi * C_7 * F_{Z2}} - R_{10}; R_8 = 6.63 \text{ k}\Omega$$

Select  $R_8 = 6.65 \text{ k}\Omega$

**Programming the Current-Limit**

The Current-Limit threshold can be set by connecting a resistor ( $R_{OCSET}$ ) from the SW pin to the OCSet pin. The resistor can be calculated by using equation (4). This resistor  $R_{OCSET}$  must be placed close to the IC.

The  $R_{DS(on)}$  has a positive temperature coefficient and it should be considered for the worst case operation.

$$I_{SET} = I_{L(critical)} = \frac{R_{OCSet} * I_{OCSet}}{R_{DS(on)}} \dots\dots\dots(32)$$

$$R_{DS(on)} = 8.5 \text{ m}\Omega * 1.25 = 10.625 \text{ m}\Omega$$

$$I_{SET} \cong I_{o(LIM)} = 8 \text{ A} * 1.5 = 12 \text{ A}$$

(50% over nominal output current)

$$I_{OCSet} = 39.22 \mu\text{A (at } F_s = 400 \text{ kHz)}$$

$$R_{OCSet} = 3.25 \text{ k}\Omega \text{ Select } R_7 = 3.24 \text{ k}\Omega$$

**Setting the Power Good Threshold**

A window comparator internally sets a lower Power Good threshold at 85% of  $V_p$  and an upper Power Good threshold at 115% of  $V_p$ . When the voltage at the FB pin is within the window set by these thresholds, PGood is asserted.

The PGood is an open drain output. Hence, it is necessary to use a pull up resistor  $R_{PG}$  from PGood pin to  $V_{cc}$ . The value of the pull-up resistor must be chosen such as to limit the current flowing into the PGood pin, when the output voltage is not in regulation, to less than 5 mA. A typical value used is 4.7k $\Omega$ .

**Application Diagram:**

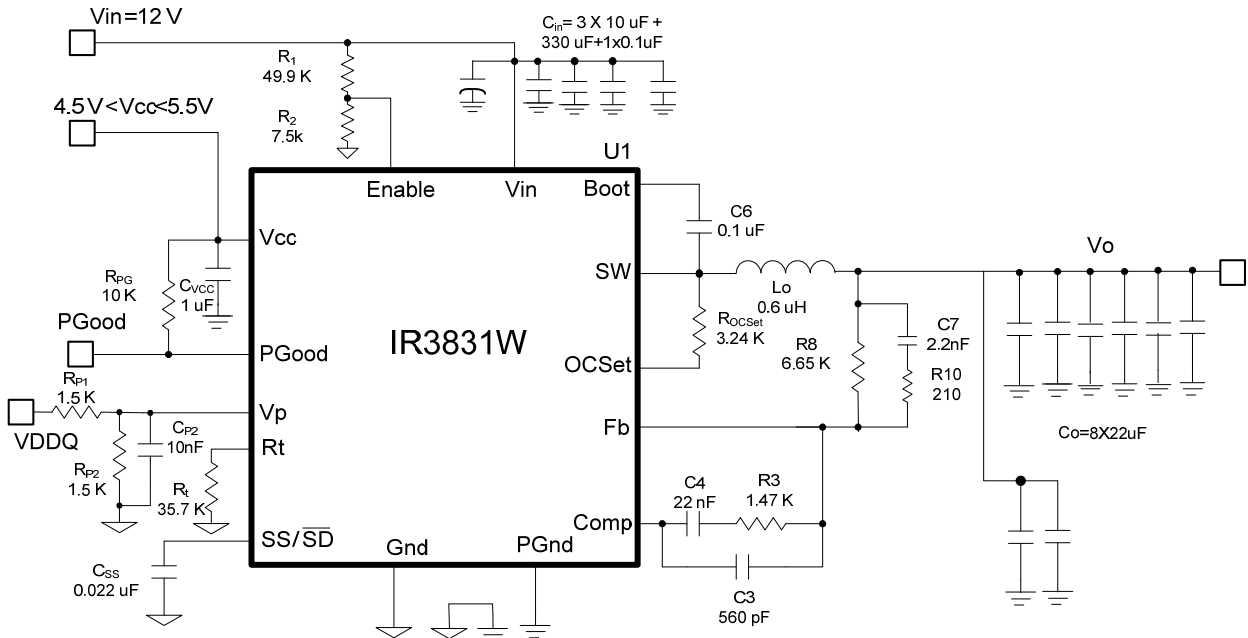

Fig. 15. Application circuit diagram for a 12V to 0.75 V, 8 A Point Of Load Converter

**Suggested Bill of Materials for the application circuit:**

Part Reference	Quantity	Value	Description	Manufacturer	Part Number
C <sub>in</sub>	1	330uF	SMD Electrolytic, Fsize, 25V, 20%	Panasonic	EEV-FK1E331P
	3	10uF	1206, 16V, X5R, 20%	TDK	C3216X5R1E106M
	1	0.1uF	0603, 25V, X7R, 10%	Panasonic	ECJ-1VB1E104K
L <sub>o</sub>	1	0.6uH	11.5x10x4mm, 20%, 1.7mOhm	Delta	MPL104-0R6
C <sub>o</sub>	8	22uF	0805, 6.3V, X5R, 20%	Panasonic	ECJ-2FB0J226ML
R <sub>1</sub>	1	49.9k	Thick Film, 0603, 1/10 W, 1%	Rohm	MCR03EZPFX4992
R <sub>2</sub>	1	7.5k	Thick Film, 0603, 1/10W, 1%	Rohm	MCR03EZPFX7501
R <sub>t</sub>	1	35.7k	Thick Film, 0603, 1/10W, 1%	Rohm	MCR03EZPFX3572
R <sub>ocset</sub>	1	3.24k	Thick Film, 0603, 1/10W, 1%	Rohm	MCR03EZPFX3241
R <sub>PG</sub>	1	10k	Thick Film, 0603, 1/10W, 1%	Rohm	MCR03EZPFX1002
C <sub>ss</sub>	1	0.022uF	0603, 25V, X7R, 10%	Panasonic	ECJ-1VB1E223K
R <sub>3</sub>	1	1.47k	Thick Film, 0603, 1/10W, 1%	Rohm	MCR03EZPFX1471
C <sub>3</sub>	1	560pF	50V, 0603, NPO, 5%	Panasonic	ECJ-1VC1H561J
C <sub>6</sub>	1	0.1uF	0603, 25V, X7R, 10%	Panasonic	ECJ-1VB1E104K
C <sub>4</sub>	1	2200pF	0603, 50V, X7R, 10%	Panasonic	ECJ-1VB1H223K
R <sub>8</sub>	1	6.65k	Thick Film, 0603, 1/10W, 1%	Rohm	MCR03EZPFX6651
R <sub>10</sub>	1	210	Thick Film, 0603, 1/10W, 1%	Rohm	ERJ-3EKF2100V
C <sub>7</sub>	1	2200pF	0603, 50V, X7R, 10%	Panasonic	ECJ-1VB1H222K
C <sub>p2</sub>	1	22nF	0603, 50V, X7R, 10%	Panasonic	ECJ-1VB1H223K
C <sub>Vcc</sub>	1	1.0uF	0603, 16V, X5R, 20%	Panasonic	ECJ-BVB1C105M
U <sub>1</sub>	1	IR3831W	SuplIRBuck, 8A, PQFN 5x6mm	International Rectifier	IR3831WMPbF

**TYPICAL OPERATING WAVEFORMS**

**Vin=12.0V, Vcc=5V, Vo=0.75V, Io=0- ±8A, Room Temperature, No Air Flow**

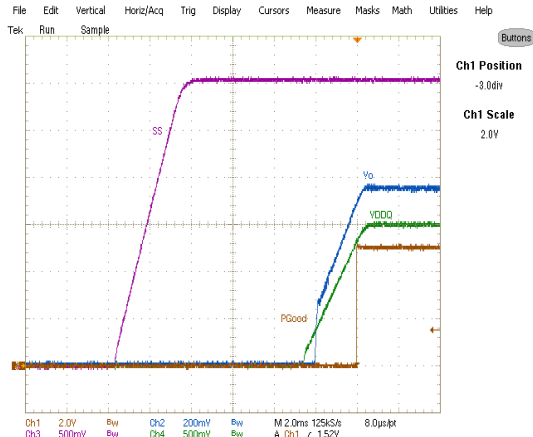

Fig. 16: Start up at 8A, sourcing current  
 Ch<sub>1</sub>:PGood, Ch<sub>2</sub>:V<sub>out</sub>, Ch<sub>3</sub>:SS, Ch<sub>4</sub>:V<sub>DDQ</sub>

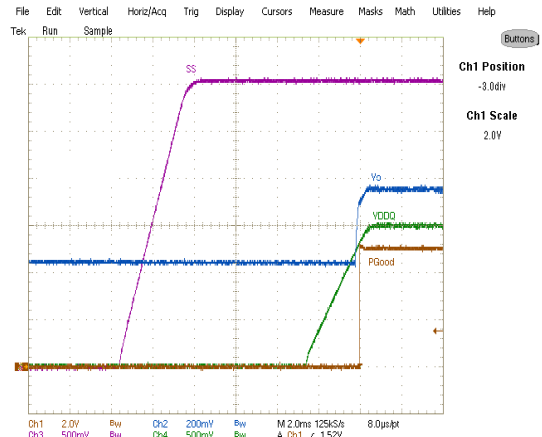

Fig. 17: Start up with Prebias, 0A Load  
 Ch<sub>1</sub>:PGood, Ch<sub>2</sub>:V<sub>out</sub>, Ch<sub>3</sub>:SS, Ch<sub>4</sub>:V<sub>DDQ</sub>

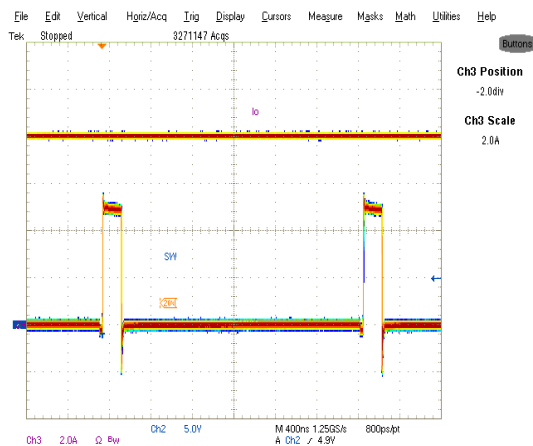

Fig. 18: Inductor node at 8A, sourcing current, Ch<sub>3</sub>:SW, Ch<sub>4</sub>:I<sub>out</sub>

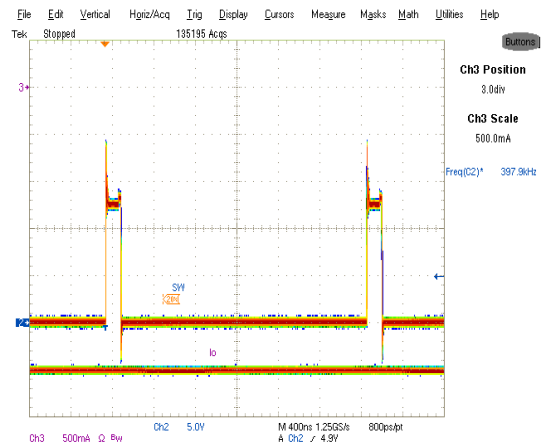

Fig. 19: Inductor node at -3A, sinking current, Ch<sub>3</sub>:SW, Ch<sub>4</sub>:I<sub>out</sub>

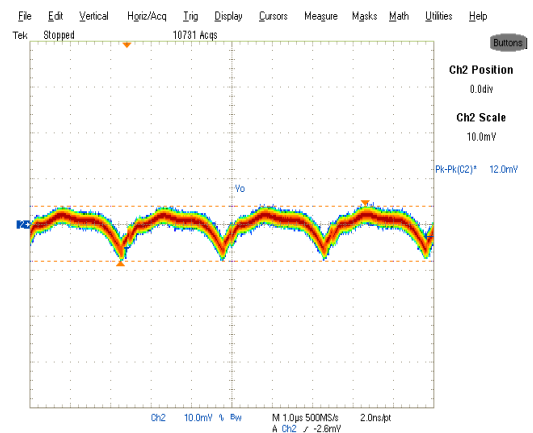

Fig. 20: Output Voltage Ripple, 8A, sourcing current, Ch<sub>2</sub>: V<sub>out</sub>

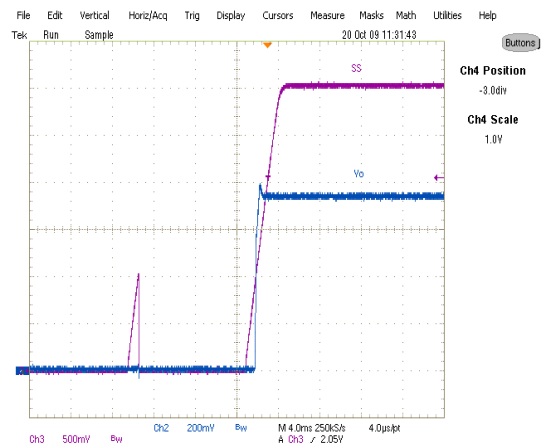

Fig. 21: Short (Hiccup) Recovery  
 Ch<sub>2</sub>:V<sub>out</sub>, Ch<sub>3</sub>:V<sub>SS</sub>, Ch<sub>4</sub>:PGood

**TYPICAL OPERATING WAVEFORMS**

**V<sub>in</sub>=12V, V<sub>cc</sub>=5V, V<sub>o</sub>=0.75V, Room Temperature, No Air Flow**

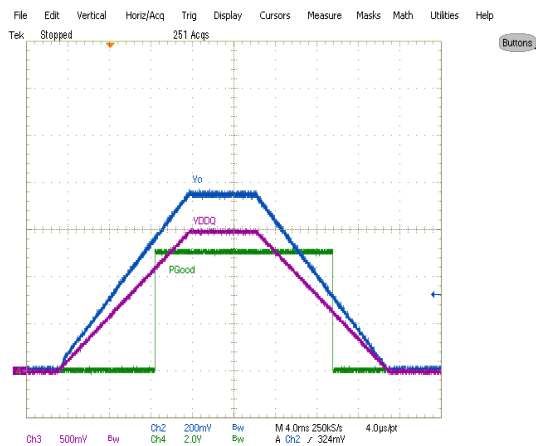

Fig. 22: Tracking 8A, sourcing current,  
 Ch<sub>2</sub>:V<sub>out</sub>, Ch<sub>3</sub>:V<sub>DDQ</sub>, Ch<sub>4</sub>:PGood

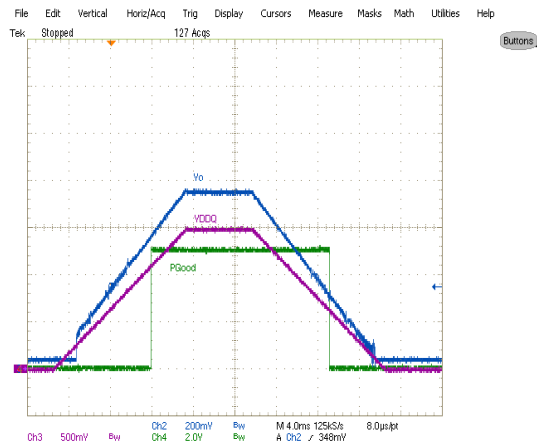

Fig. 23: Tracking -3A load, sinking current,  
 Ch<sub>2</sub>:V<sub>out</sub>, Ch<sub>2</sub>: I<sub>L</sub>, Ch<sub>3</sub>:V<sub>DDQ</sub>, Ch<sub>4</sub>:PGood

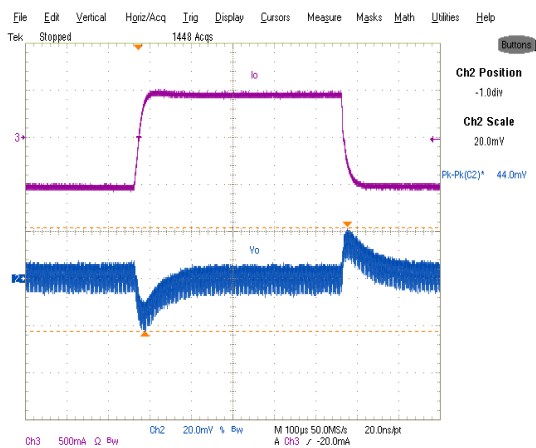

Fig. 24: Transient Response, 1A/us  
 -0.5A to +0.5A load , Ch<sub>1</sub>:V<sub>out</sub>, Ch<sub>3</sub>:I<sub>o</sub>

**TYPICAL OPERATING WAVEFORMS**

**Vin=12V, Vcc=5V, Vo=0.75V, Io=+8A, Room Temperature, No Air Flow**

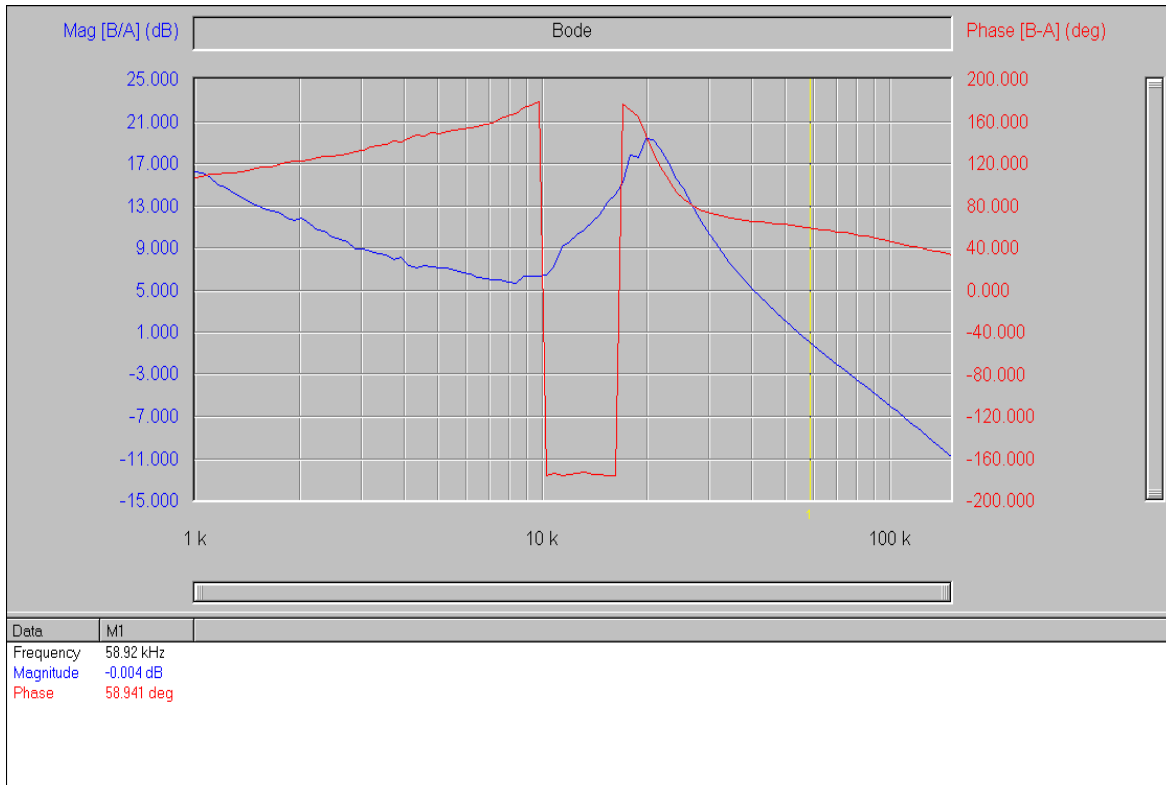

Fig. 25: Bode Plot at 8A load (sourcing current) shows a bandwidth of 59kHz and phase margin of 59 degrees

**Layout Considerations**

The layout is very important when designing high frequency switching converters. Layout will affect noise pickup and can cause a good design to perform with less than expected results.

Make all the connections for the power components in the top layer with wide, copper filled areas or polygons. In general, it is desirable to make proper use of power planes and polygons for power distribution and heat dissipation.

The inductor, output capacitors and the IR3831W should be as close to each other as possible. This helps to reduce the EMI radiated by the power traces due to the high switching currents through them. Place the input capacitor directly at the Vin pin of IR3831W.

The feedback part of the system should be kept away from the inductor and other noise sources.

The critical bypass components such as capacitors for Vcc should be close to their respective pins. It is important to place the feedback components including feedback resistors and compensation components close to Fb and Comp pins.

The connection between the OCSet resistor and the Sw pin should not share any trace with the connection between the bootstrap capacitor and the Sw pin. Instead, it is recommended to use a Kelvin connection of the trace from the OCSet resistor and the trace from the bootstrap capacitor at the Sw pin.

In a multilayer PCB use one layer as a power ground plane and have a control circuit ground (analog ground), to which all signals are referenced. The goal is to localize the high current path to a separate loop that does not interfere with the more sensitive analog control function. These two grounds must be connected together on the PC board layout at a single point. The Power QFN is a thermally enhanced package. Based on thermal performance it is recommended to use at least a 4-layer PCB. To effectively remove heat from the device the exposed pad should be connected to the ground plane using vias. Figure 26 illustrates the implementation of the layout guidelines outlined above, on a 4 layer board.

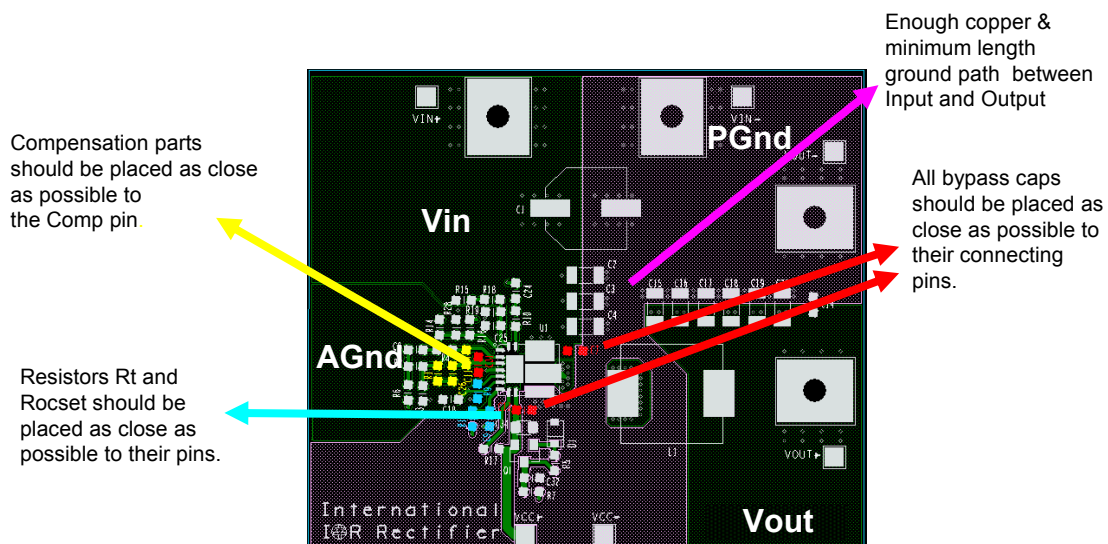

Fig. 26a. IR3831W layout considerations – Top Layer

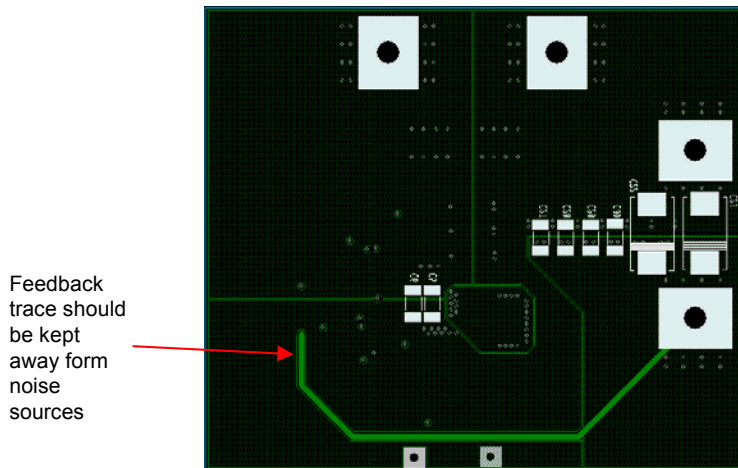

Fig. 26b. IR3831W layout considerations – Bottom Layer

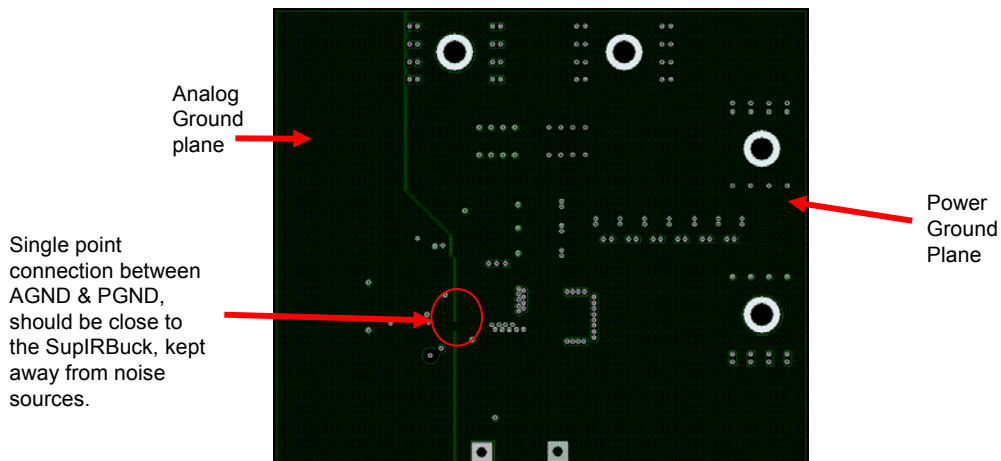

Fig. 26c. IR3831W layout considerations – Mid Layer 1

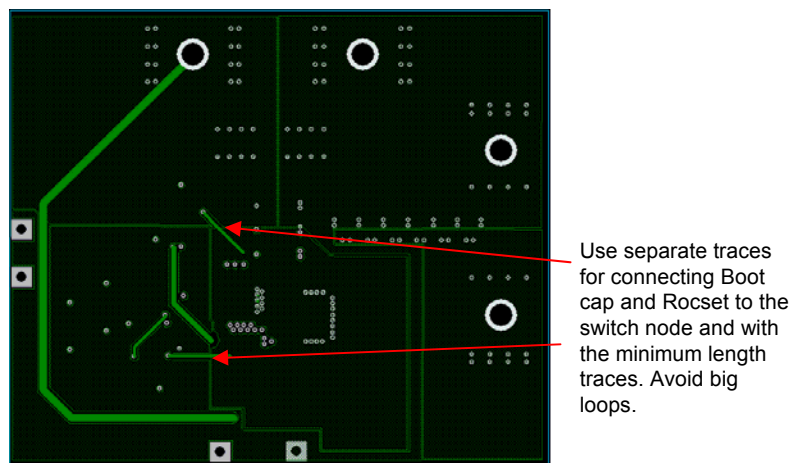

Fig. 26d. IR3831W layout considerations – Mid Layer 2

**PCB Metal and Components Placement**

Lead lands (the 11 IC pins) width should be equal to nominal part lead width. The minimum lead to lead spacing should be  $\geq 0.2\text{mm}$  to minimize shorting.

Lead land length should be equal to maximum part lead length + 0.3 mm outboard extension. The outboard extension ensures a large and inspectable toe fillet.

Pad lands (the 4 big pads other than the 11 IC pins) length and width should be equal to maximum part pad length and width. However, the minimum metal to metal spacing should be no less than 0.17mm for 2 oz. Copper; no less than 0.1mm for 1 oz. Copper and no less than 0.23mm for 3 oz. Copper.

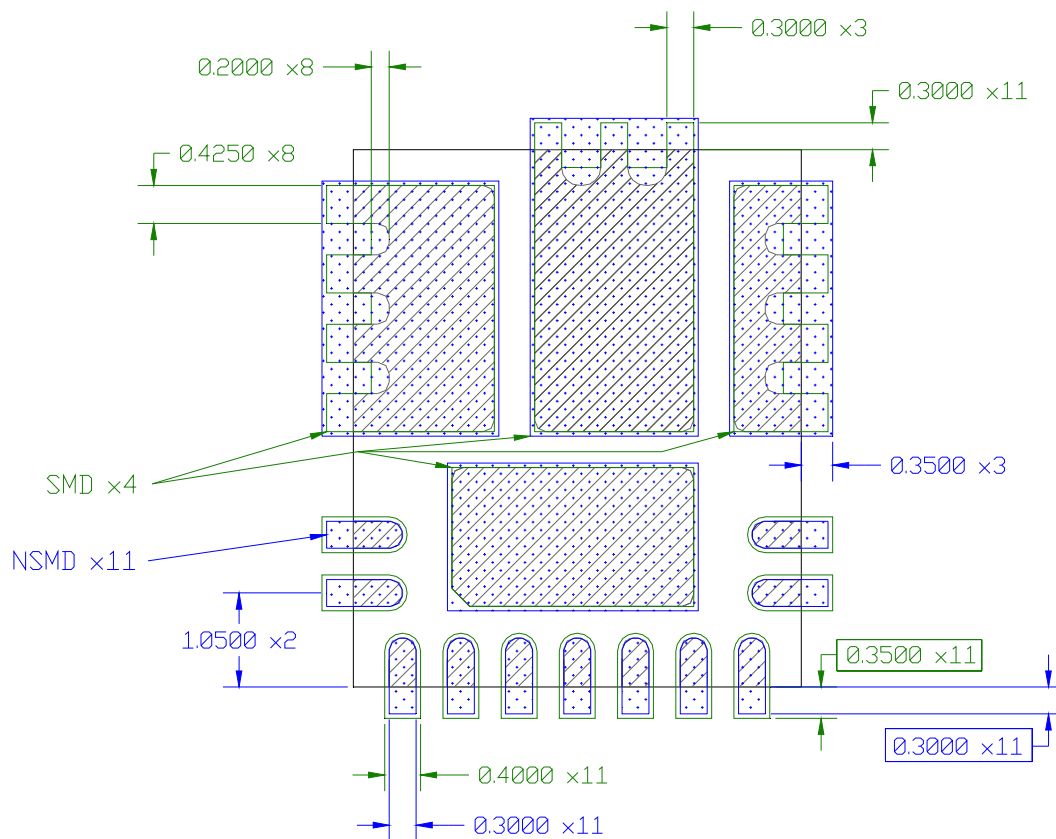

All Dimensions in mm

-  PCB Copper
-  Component

### Solder Resist

It is recommended that the lead lands are Non Solder Mask Defined (NSMD). The solder resist should be pulled away from the metal lead lands by a minimum of 0.025mm to ensure NSMD pads.

The land pad should be Solder Mask Defined (SMD), with a minimum overlap of the solder resist onto the copper of 0.05mm to accommodate solder resist mis-alignment.

Ensure that the solder resist in-between the lead lands and the pad land is  $\geq 0.15\text{mm}$  due to the high aspect ratio of the solder resist strip separating the lead lands from the pad land.

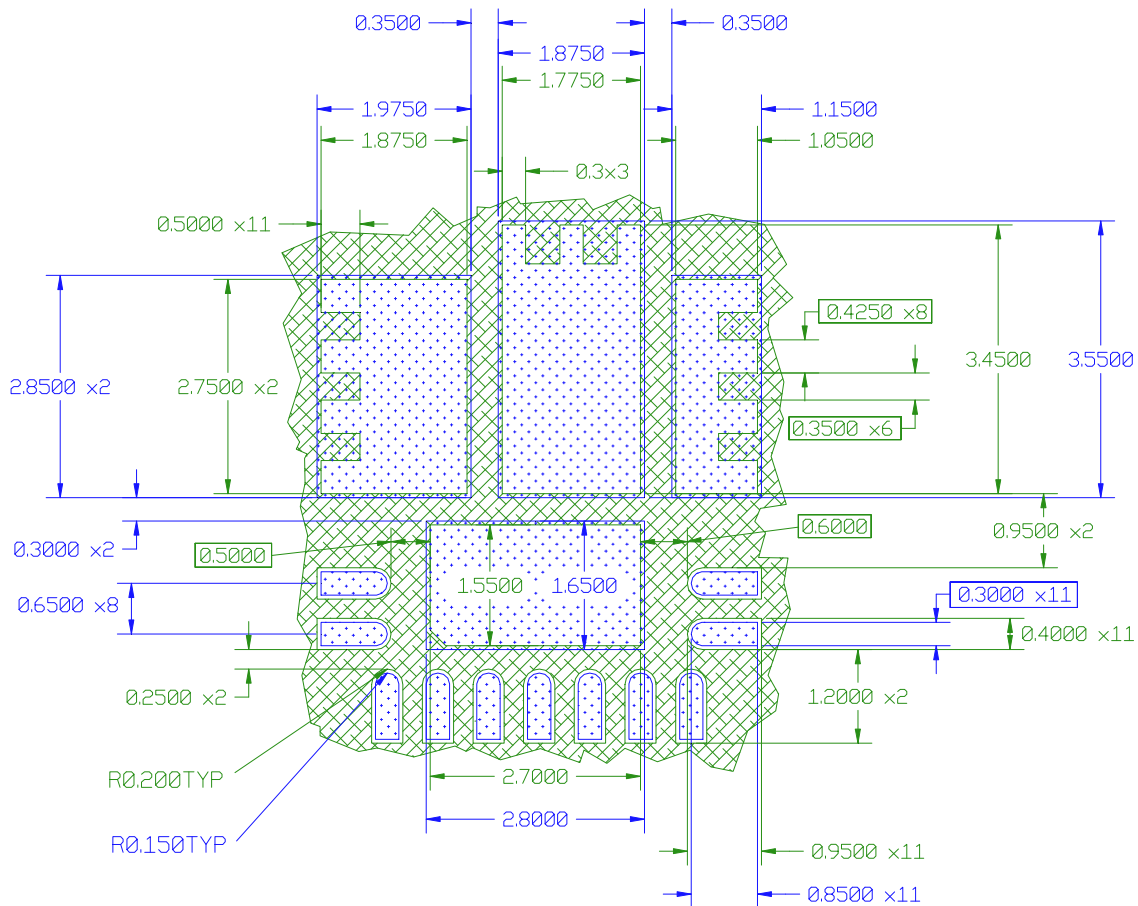

All Dimensions in mm

NOTE:

-  PCB Copper
-  PCB Solder Resist

11x Signal Pins are NSMD  
 4x Power Pins are SMD

### Stencil Design

- The Stencil apertures for the lead lands should be approximately 80% of the area of the lead lads. Reducing the amount of solder deposited will minimize the occurrences of lead shorts. If too much solder is deposited on the center pad the part will float and the lead lands will be open.
- The maximum length and width of the land pad stencil aperture should be equal to the solder resist opening minus an annular 0.2mm pull back to decrease the incidence of shorting the center land to the lead lands when the part is pushed into the solder paste.

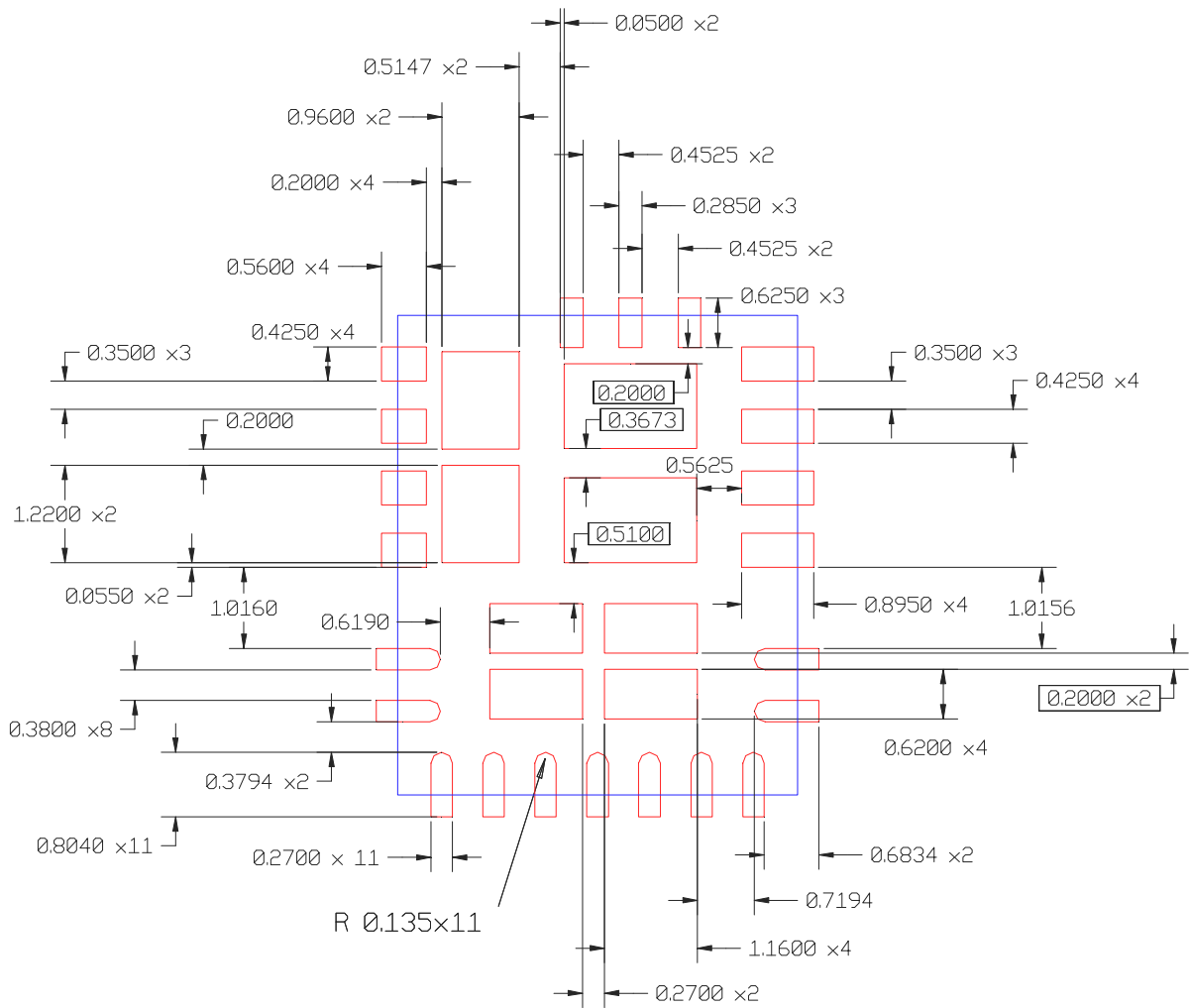

Stencil Aperture  
All Dimensions in mm

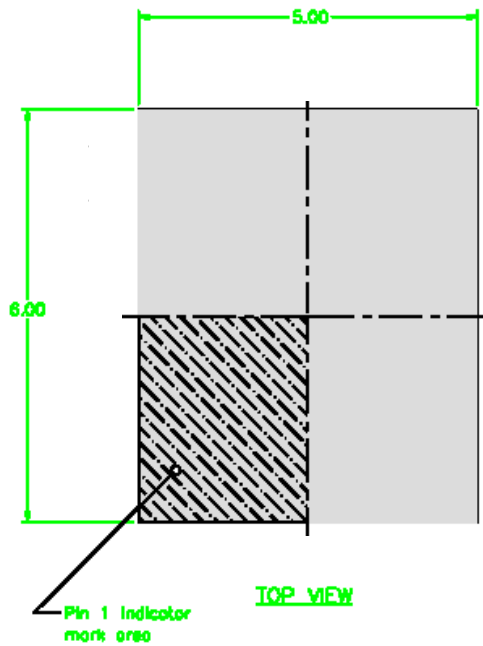
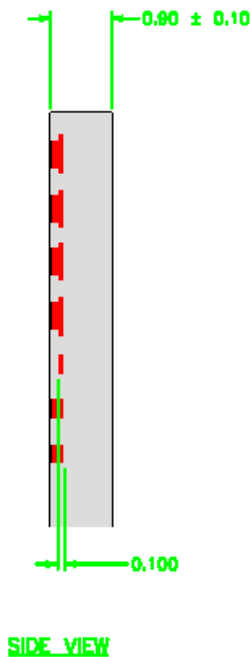
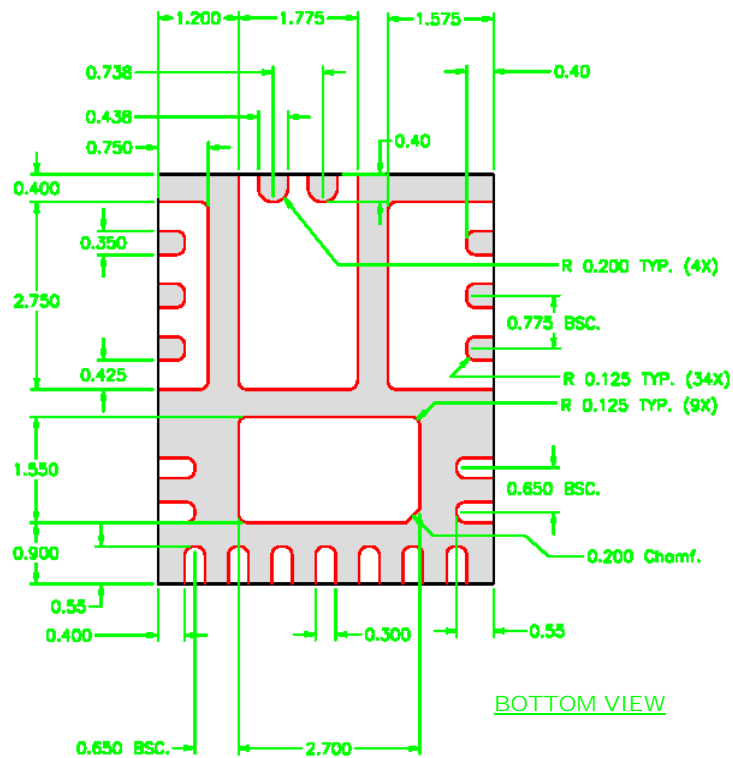

UNLESS OTHERWISE SPECIFIED  
 DIMENSIONS ARE IN MILLIMETERS

DECIMAL	ANGULAR
X.X ±	±1°
X.XX ± 0.10	
X.XXX ± 0.050	

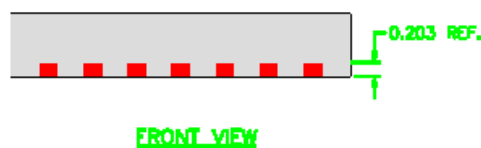

IR WORLD HEADQUARTERS: 233 Kansas St., El Segundo, California 90245, USA Tel: (310) 252-7105  
 TAC Fax: (310) 252-7903

This product has been designed and qualified for the Industrial market (Note5)

Visit us at [www.irf.com](http://www.irf.com) for sales contact information

Data and specifications subject to change without notice. 08/11

## Looking for pricing, stock, or lifecycle information?

Click below to explore more details on WIN SOURCE:

-  [View IR3831WMTRPBF](#) on WIN SOURCE
-  [Infineon Technologies](#) Information

## Optimize Your Supply Chain with WIN SOURCE Solutions

-  Global Sourcing Solution
-  Obsolete Management
-  Cost Control Management
-  Shortage Management
-  Alternative Solution
-  Excess Inventory Management