

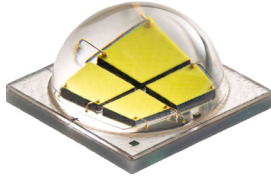

**THE DATASHEET OF
MKRAWT-00-0000-0D0HH40E5**



XLamp® MK-R LEDs



PRODUCT DESCRIPTION

XLamp® MK-R LEDs were Cree LED's first generation of multi-die 7.0 x 7.0 mm LEDs that delivered unprecedented lumen density and efficacy for a single LED package at the time. The XLamp MK-R LED is optimized for directional lighting applications and is a welcome addition to applications requiring high lumen output, a compact optical source and a broad palette of color temperature and CRI values.

Cree LED encourages manufacturers to consider the newer generations of XLamp XHP70 LEDs that are now available, since the XHP70 LED family incorporates many performance and optical enhancements that are not present with the MK-R LED.

FEATURES

- Available in ANSI white bins as well as 4-step and 2-step EasyWhite bins at 2700 K, 3000 K, 3500 K, 4000 K, 4500 K and 5000 K CCT
- Voltage option: 12 V
- Low thermal resistance: 0.6 °C/W
- Maximum junction temperature: 150 °C
- Binned at 85 °C
- Viewing angle: 120°
- Available in cool white, 70-, 80- and 90-CRI minimums
- Unlimited floor life at ≤ 30 °C/85% RH
- Reflow solderable - JEDEC J-STD-020C
- Electrically neutral thermal path
- RoHS and REACH compliant
- UL® recognized component (E349212)



Cree LED / 4001 E. Hwy. 54, Suite 2000 / Durham, NC 27713 USA / +1.919.313.5330 / www.cree-led.com

TABLE OF CONTENTS

Characteristics	3
Flux Characteristics, EasyWhite® Order Codes and Bins.....	4
Flux Characteristics, ANSI White Order Codes and Bins	6
Relative Spectral Power Distribution	9
Relative Flux vs. Junction Temperature.....	9
Electrical Characteristics.....	10
Relative Flux vs. Current	10
Relative Chromaticity vs. Current - Warm White	11
Relative Chromaticity vs. Temperature - Warm White	11
Typical Spatial Distribution.....	12
Thermal Design	12
Performance Groups - Luminous Flux.....	13
Performance Groups - Chromaticity	14
EasyWhite® Bins Plotted on the 1931 CIE Color Space.....	18
Standard Cool White Kits Plotted on ANSI Standard Chromaticity Regions.....	19
Standard Warm and Neutral White Kits Plotted on ANSI Standard Chromaticity Regions	19
Bin and Order Code Formats	20
Reflow Soldering Characteristics.....	21
Notes	22
Mechanical Dimensions	24
Tape and Reel.....	25
Packaging.....	27

CHARACTERISTICS

Characteristics	Unit	Minimum	Typical	Maximum
Thermal resistance, junction to solder point ^o	°C/W		0.6	
Viewing angle - full width half maximum (FWHM)	degrees		120	
Temperature coefficient of voltage (700 mA, 85 °C)	mV/°C		-8	
ESD withstand voltage (HBM per Mil-Std-883D)			Class 3B	
DC forward current (700 mA, 85 °C)	mA			1250
Reverse voltage	V			1
Forward voltage (700 mA, 85 °C)	V		11.7	14
LED junction temperature	°C			150

Note:

- ◇ Thermal resistance measurement was performed per the JEDEC JESD51-14 standard. See the [Thermal Resistance Measurement application note](#) for more details.

FLUX CHARACTERISTICS, EASYWHITE® ORDER CODES AND BINS ($I_F = 700 \text{ mA}$, $T_J = 85 \text{ °C}$)

The following tables provide order codes for XLamp MK-R LEDs. For a complete description of the order code nomenclature, please reference Bin and Order Code Formats (page 20).

Color	CCT Range	Minimum Luminous Flux**			2-Step		4-Step	
		Group	Flux (lm) @ 85 °C	Flux (lm) @ 25 °C*	Chromaticity Region	Order Code	Chromaticity Region	Order Code
80-CRI EasyWhite	5000 K	H4	970	1091	50H	MKRAWT-00-0000-0D0HH450H	50F	MKRAWT-00-0000-0D0HH450F
		H2	900	1012		MKRAWT-00-0000-0D0HH250H		MKRAWT-00-0000-0D0HH250F
		G4	840	945		MKRAWT-00-0000-0D0HG450H		MKRAWT-00-0000-0D0HG450F
	4500 K	H4	970	1091	45H	MKRAWT-00-0000-0D0HH445H	45F	MKRAWT-00-0000-0D0HH445F
		H2	900	1012		MKRAWT-00-0000-0D0HH245H		MKRAWT-00-0000-0D0HH245F
		G4	840	945		MKRAWT-00-0000-0D0HG445H		MKRAWT-00-0000-0D0HG445F
	4000 K	H4	970	1091	40H	MKRAWT-00-0000-0D0HH440H	40F	MKRAWT-00-0000-0D0HH440F
		H2	900	1012		MKRAWT-00-0000-0D0HH240H		MKRAWT-00-0000-0D0HH240F
		G4	840	945		MKRAWT-00-0000-0D0HG440H		MKRAWT-00-0000-0D0HG440F
	3500 K	H4	970	1091	35H	MKRAWT-00-0000-0D0HH435H	35F	MKRAWT-00-0000-0D0HH435F
		H2	900	1012		MKRAWT-00-0000-0D0HH235H		MKRAWT-00-0000-0D0HH235F
		G4	840	945		MKRAWT-00-0000-0D0HG435H		MKRAWT-00-0000-0D0HG435F
		G2	780	877		MKRAWT-00-0000-0D0HG235H		MKRAWT-00-0000-0D0HG235F
	3000 K	H2	900	1012	30H	MKRAWT-00-0000-0D0HH230H	30F	MKRAWT-00-0000-0D0HH230F
		G4	840	945		MKRAWT-00-0000-0D0HG430H		MKRAWT-00-0000-0D0HG430F
		G2	780	877		MKRAWT-00-0000-0D0HG230H		MKRAWT-00-0000-0D0HG230F
	2700 K	H2	900	1012	27H	MKRAWT-00-0000-0D0HH227H	27F	MKRAWT-00-0000-0D0HH227F
		G4	840	945		MKRAWT-00-0000-0D0HG427H		MKRAWT-00-0000-0D0HG427F
		G2	780	877		MKRAWT-00-0000-0D0HG227H		MKRAWT-00-0000-0D0HG227F
		F4	730	821		MKRAWT-00-0000-0D0HF427H		MKRAWT-00-0000-0D0HF427F

Notes:

- Cree LED maintains a tolerance of $\pm 7\%$ on flux and power measurements, ± 0.005 on chromaticity (CCx, CCy) measurements and ± 2 on CRI measurements. See the Measurements section (page 22).
- Minimum CRI for 80-CRI White is 80.
- * Flux values @ 25 °C are calculated and for reference only.
- ** XLamp MK-R LED order codes specify only a minimum flux bin and not a maximum. Cree LED may ship reels in flux bins higher than the minimum specified by the order code without advance notice. Shipments will always adhere to the chromaticity restrictions specified by the order code.

FLUX CHARACTERISTICS, EASYWHITE® ORDER CODES AND BINS ($I_f = 700 \text{ mA}$, $T_j = 85 \text{ °C}$) - CONTINUED

Color	CCT Range	Minimum Luminous Flux**			2-Step		4-Step	
		Group	Flux (lm) @ 85 °C	Flux (lm) @ 25 °C*	Chromaticity Region	Order Code	Chromaticity Region	Order Code
90-CRI EasyWhite	3000 K	F4	730	821	30H	MKRAWT-00-0000-0D0UF430H	30F	MKRAWT-00-0000-0D0UF430F
		F2	680	765		MKRAWT-00-0000-0D0UF230H		MKRAWT-00-0000-0D0UF230F
		E4	635	714		MKRAWT-00-0000-0D0UE430H		MKRAWT-00-0000-0D0UE430F
		E2	590	664		MKRAWT-00-0000-0D0UE230H		MKRAWT-00-0000-0D0UE230F
	2700 K	F2	680	765	27H	MKRAWT-00-0000-0D0UF227H	27F	MKRAWT-00-0000-0D0UF227F
		E4	635	714		MKRAWT-00-0000-0D0UE427H		MKRAWT-00-0000-0D0UE427F
		E2	590	664		MKRAWT-00-0000-0D0UE227H		MKRAWT-00-0000-0D0UE227F
		D4	550	619		MKRAWT-00-0000-0D0UD427H		MKRAWT-00-0000-0D0UD427F

Notes:

- Cree LED maintains a tolerance of $\pm 7\%$ on flux and power measurements, ± 0.005 on chromaticity (CCx, CCy) measurements and ± 2 on CRI measurements. See the Measurements section (page 22).
- Minimum CRI for 90-CRI White is 90.
- * Flux values @ 25 °C are calculated and for reference only.
- ** XLamp MK-R LED order codes specify only a minimum flux bin and not a maximum. Cree LED may ship reels in flux bins higher than the minimum specified by the order code without advance notice. Shipments will always adhere to the chromaticity restrictions specified by the order code.

FLUX CHARACTERISTICS, ANSI WHITE ORDER CODES AND BINS ($I_F = 700 \text{ mA}$, $T_J = 85 \text{ °C}$)

Chromaticity		Minimum Luminous Flux**			Order Codes			
Kit	CCT	Code	Flux (lm) @ 85 °C	Flux (lm) @ 25 °C*	65 CRI Typical	70 CRI Minimum	80 CRI Minimum	90 CRI Minimum
51	6200 K	J4	1120	1260	MKRAWT-00-0000-0D00J4051	MKRAWT-00-0000-0D0BJ4051		
		J2	1040	1170	MKRAWT-00-0000-0D00J2051	MKRAWT-00-0000-0D0BJ2051		
		H4	970	1091	MKRAWT-00-0000-0D00H4051	MKRAWT-00-0000-0D0BH4051		
		H2	900	1012		MKRAWT-00-0000-0D0BH2051		
E1	6500 K	J4	1120	1260	MKRAWT-00-0000-0D00J40E1			
		J2	1040	1170	MKRAWT-00-0000-0D00J20E1	MKRAWT-00-0000-0D0BJ20E1		
		H4	970	1091	MKRAWT-00-0000-0D00H40E1	MKRAWT-00-0000-0D0BH40E1		
		H2	900	1012		MKRAWT-00-0000-0D0BH20E1		
E2	5700 K	J4	1120	1260	MKRAWT-00-0000-0D00J40E2	MKRAWT-00-0000-0D0BJ40E2		
		J2	1040	1170	MKRAWT-00-0000-0D00J20E2	MKRAWT-00-0000-0D0BJ20E2		
		H4	970	1091	MKRAWT-00-0000-0D00H40E2	MKRAWT-00-0000-0D0BH40E2		
		H2	900	1012		MKRAWT-00-0000-0D0BH20E2		
E3	5000 K	J2	1040	1170	MKRAWT-00-0000-0D00J20E3	MKRAWT-00-0000-0D0BJ20E3		
		H4	970	1091	MKRAWT-00-0000-0D00H40E3	MKRAWT-00-0000-0D0BH40E3	MKRAWT-00-0000-0D0HH40E3	
		H2	900	1012	MKRAWT-00-0000-0D00H20E3	MKRAWT-00-0000-0D0BH20E3	MKRAWT-00-0000-0D0HH20E3	
		G4	840	945			MKRAWT-00-0000-0D0HG40E3	
E4	4500 K	J2	1040	1170	MKRAWT-00-0000-0D00J20E4	MKRAWT-00-0000-0D0BJ20E4		
		H4	970	1091	MKRAWT-00-0000-0D00H40E4	MKRAWT-00-0000-0D0BH40E4	MKRAWT-00-0000-0D0HH40E4	
		H2	900	1012	MKRAWT-00-0000-0D00H20E4	MKRAWT-00-0000-0D0BH20E4	MKRAWT-00-0000-0D0HH20E4	
		G4	840	945			MKRAWT-00-0000-0D0HG40E4	

Notes:

- Cree LED maintains a tolerance of $\pm 7\%$ on flux and power measurements, ± 0.005 on chromaticity (CCx, CCy) measurements and ± 2 on CRI measurements. See the Measurements section (page 22).
- For information on chromaticity bins contained in the kits listed above, please reference the Performance Groups - Chromaticity section starting on page 14.
- * Flux values @ 25 °C are calculated and for reference only.
- ** XLamp MK-R LED order codes specify only a minimum flux bin and not a maximum. Cree LED may ship reels in flux bins higher than the minimum specified by the order code without advance notice. Shipments will always adhere to the chromaticity restrictions specified by the order code.

FLUX CHARACTERISTICS, ANSI WHITE ORDER CODES AND BINS ($I_F = 700 \text{ mA}$, $T_J = 85 \text{ °C}$) - CONTINUED

Chromaticity		Minimum Luminous Flux**			Order Codes			
Kit	CCT	Code	Flux (lm) @ 85 °C	Flux (lm) @ 25 °C*	65 CRI Typical	70 CRI Minimum	80 CRI Minimum	90 CRI Minimum
E5	4000 K	J2	1040	1170	MKRAWT-00-0000-0D00J20E5	MKRAWT-00-0000-0D0BJ20E5		
		H4	970	1091	MKRAWT-00-0000-0D00H40E5	MKRAWT-00-0000-0D0BH40E	MKRAWT-00-0000-0D0HH40E5	
		H2	900	1012	MKRAWT-00-0000-0D00H20E5	MKRAWT-00-0000-0D0BH20E	MKRAWT-00-0000-0D0HH20E5	
		G4	840	945	MKRAWT-00-0000-0D00G40E5	MKRAWT-00-0000-0D0BG40E5	MKRAWT-00-0000-0D0HG40E5	
E6	3500 K	H4	970	1091		MKRAWT-00-0000-0D0BH40E6	MKRAWT-00-0000-0D0HH40E6	
		H2	900	1012		MKRAWT-00-0000-0D0BH20E6	MKRAWT-00-0000-0D0HH20E6	
		G4	840	945		MKRAWT-00-0000-0D0BG40E6	MKRAWT-00-0000-0D0HG40E6	
		G2	780	877			MKRAWT-00-0000-0D0HG20E6	
E7	3000 K	H4	970	1091		MKRAWT-00-0000-0D0BH40E7		
		H2	900	1012		MKRAWT-00-0000-0D0BH20E7	MKRAWT-00-0000-0D0HH20E7	
		G4	840	945		MKRAWT-00-0000-0D0BG40E7	MKRAWT-00-0000-0D0HG40E7	
		G2	780	877			MKRAWT-00-0000-0D0HG20E7	
		F4	730	821				MKRAWT-00-0000-0D0UF40E7
		F2	680	765				MKRAWT-00-0000-0D0UF20E7
		E4	635	714				MKRAWT-00-0000-0D0UE40E7
		E2	590	664				MKRAWT-00-0000-0D0UE20E7

Notes:

- Cree LED maintains a tolerance of $\pm 7\%$ on flux and power measurements, ± 0.005 on chromaticity (CCx, CCy) measurements and ± 2 on CRI measurements. See the Measurements section (page 22).
- For information on chromaticity bins contained in the kits listed above, please reference the Performance Groups - Chromaticity section starting on page 14.
- * Flux values @ 25 °C are calculated and for reference only.
- ** XLamp MK-R LED order codes specify only a minimum flux bin and not a maximum. Cree LED may ship reels in flux bins higher than the minimum specified by the order code without advance notice. Shipments will always adhere to the chromaticity restrictions specified by the order code.

FLUX CHARACTERISTICS, ANSI WHITE ORDER CODES AND BINS ($I_F = 700 \text{ mA}$, $T_J = 85 \text{ °C}$) - CONTINUED

Chromaticity		Minimum Luminous Flux**			Order Codes			
Kit	CCT	Code	Flux (lm) @ 85 °C	Flux (lm) @ 25 °C*	65 CRI Typical	70 CRI Minimum	80 CRI Minimum	90 CRI Minimum
E8	2700 K	H2	900	1012			MKRAWT-00-0000-0D0HH20E8	
		G4	840	945			MKRAWT-00-0000-0D0HG40E8	
		G2	780	877			MKRAWT-00-0000-0D0HG20E8	
		F4	730	821			MKRAWT-00-0000-0D0HF40E8	
		F2	680	765				MKRAWT-00-0000-0D0UF20E8
		E4	635	714				MKRAWT-00-0000-0D0UE40E8
		E2	590	664				MKRAWT-00-0000-0D0UE20E8
		D4	550	619				MKRAWT-00-0000-0D0UD40E8

Notes:

- Cree LED maintains a tolerance of $\pm 7\%$ on flux and power measurements, ± 0.005 on chromaticity (CCx, CCy) measurements and ± 2 on CRI measurements. See the Measurements section (page 22).
- For information on chromaticity bins contained in the kits listed above, please reference the Performance Groups - Chromaticity section starting on page 14.

* Flux values @ 25 °C are calculated and for reference only.

** XLamp MK-R LED order codes specify only a minimum flux bin and not a maximum. Cree LED may ship reels in flux bins higher than the minimum specified by the order code without advance notice. Shipments will always adhere to the chromaticity restrictions specified by the order code.

RELATIVE SPECTRAL POWER DISTRIBUTION

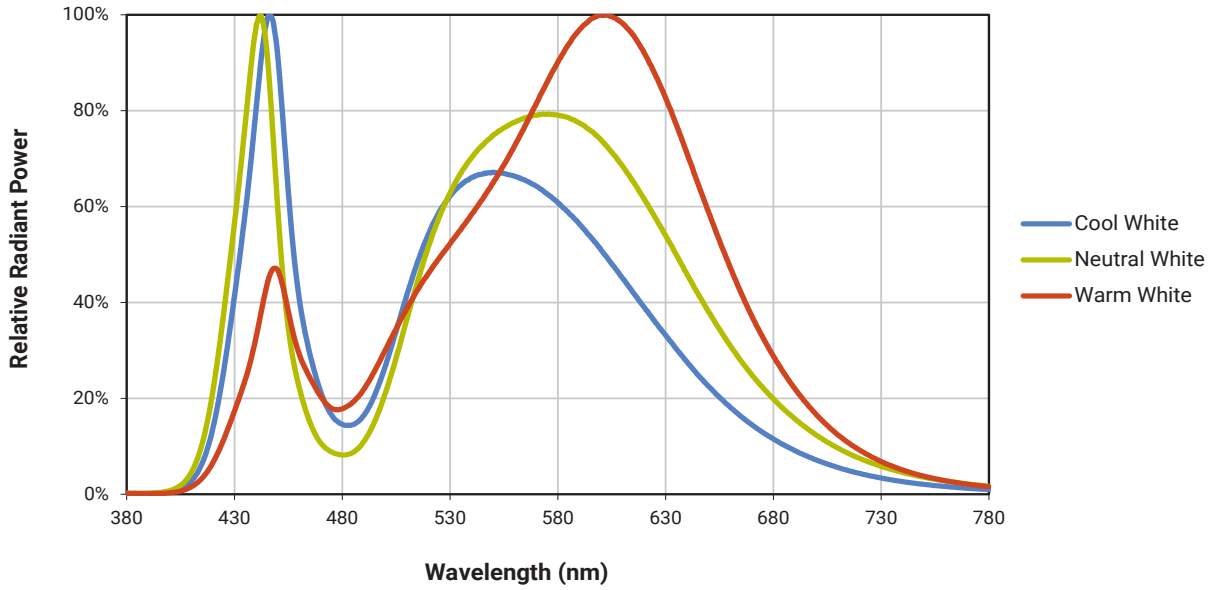

RELATIVE FLUX VS. JUNCTION TEMPERATURE

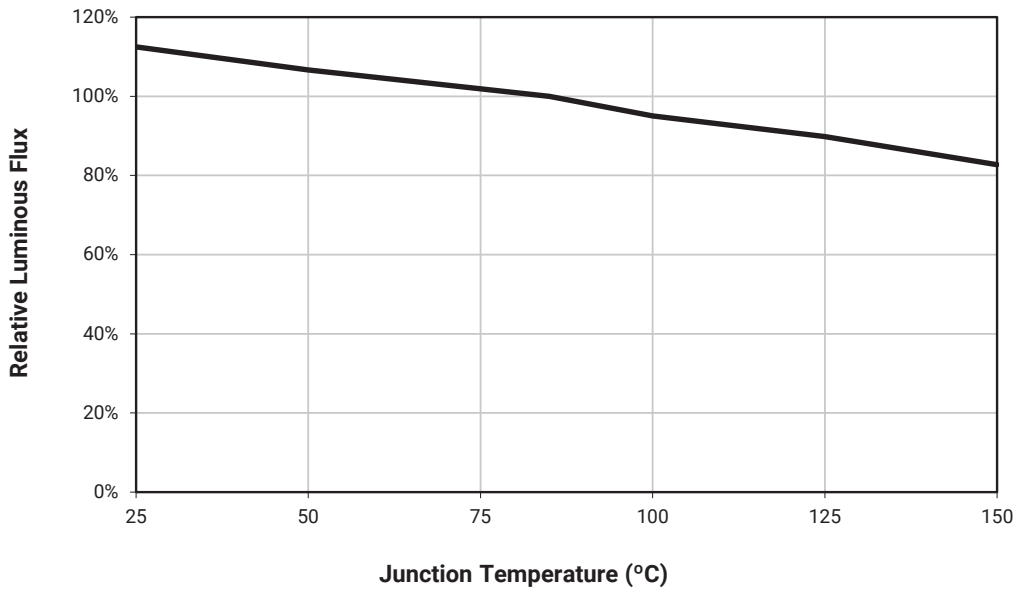

ELECTRICAL CHARACTERISTICS (T_j = 85 °C)

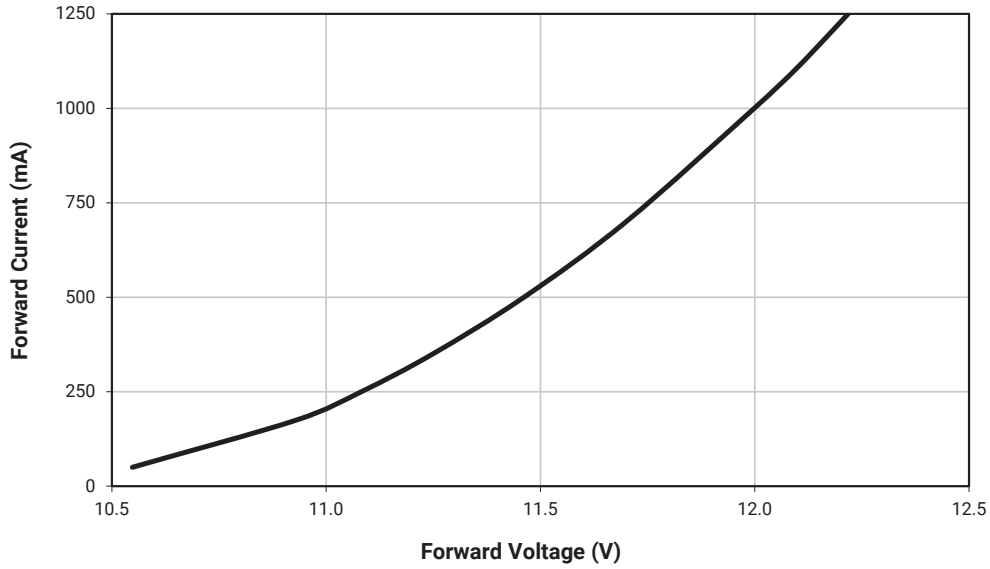

RELATIVE FLUX VS. CURRENT (T_j = 85 °C)

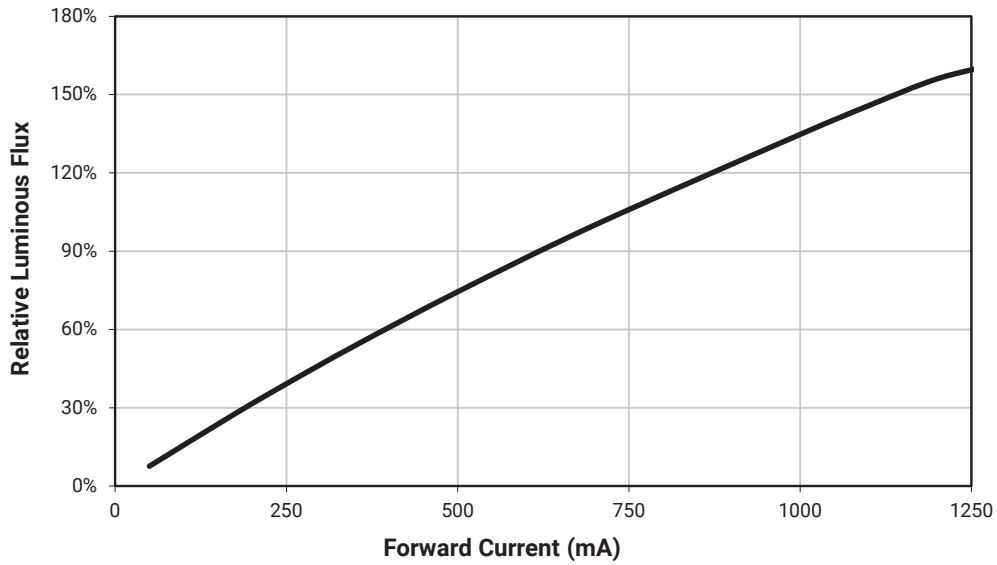

RELATIVE CHROMATICITY VS. CURRENT - WARM WHITE ($T_j = 85\text{ }^\circ\text{C}$)

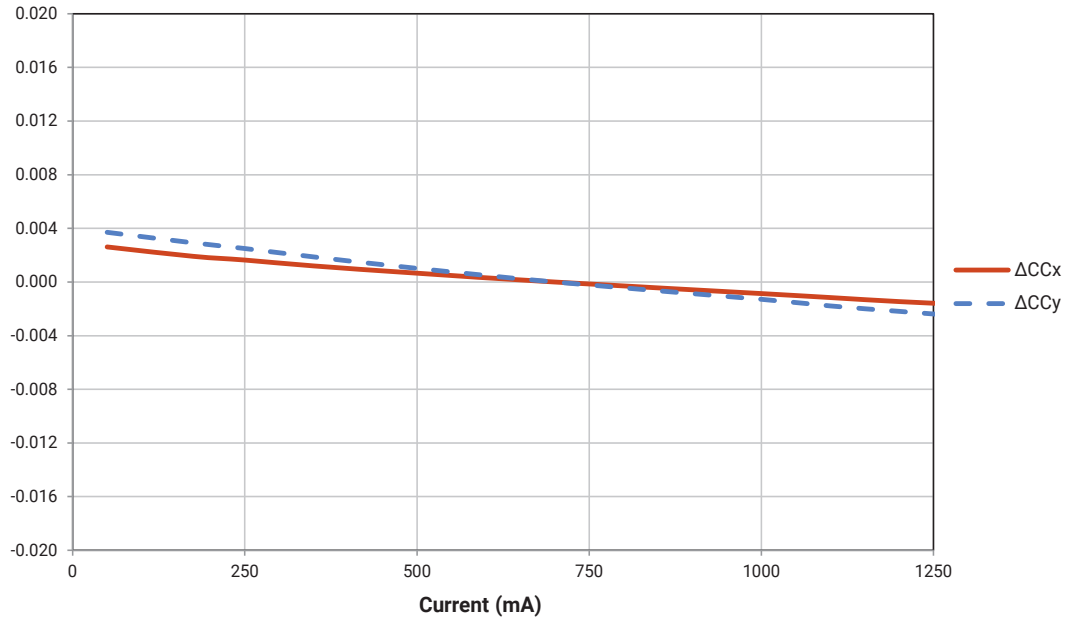

RELATIVE CHROMATICITY VS. TEMPERATURE - WARM WHITE ($I_f = 700\text{ mA}$)

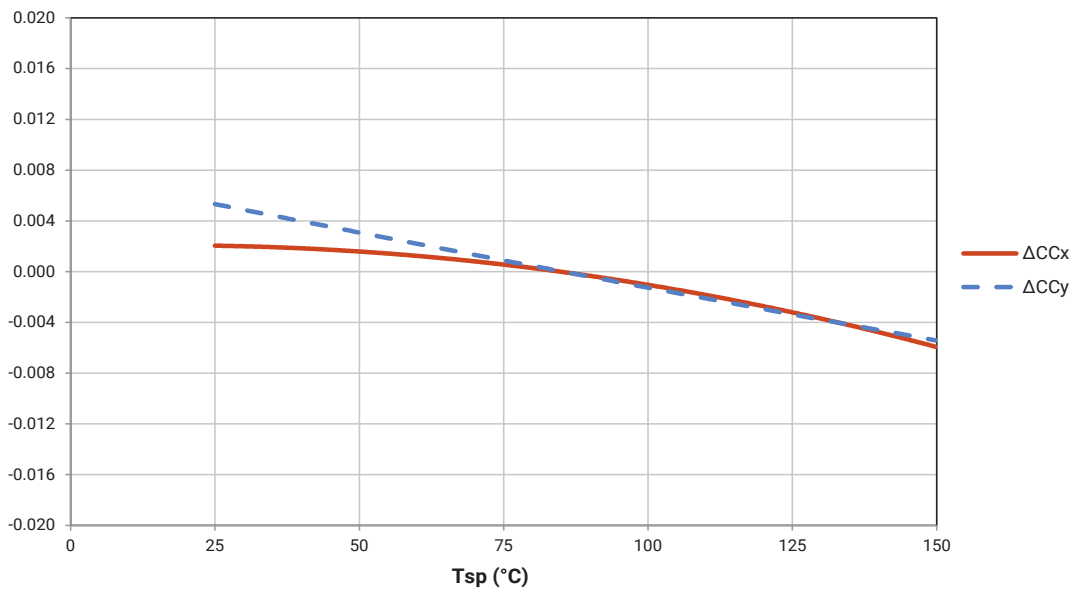

TYPICAL SPATIAL DISTRIBUTION

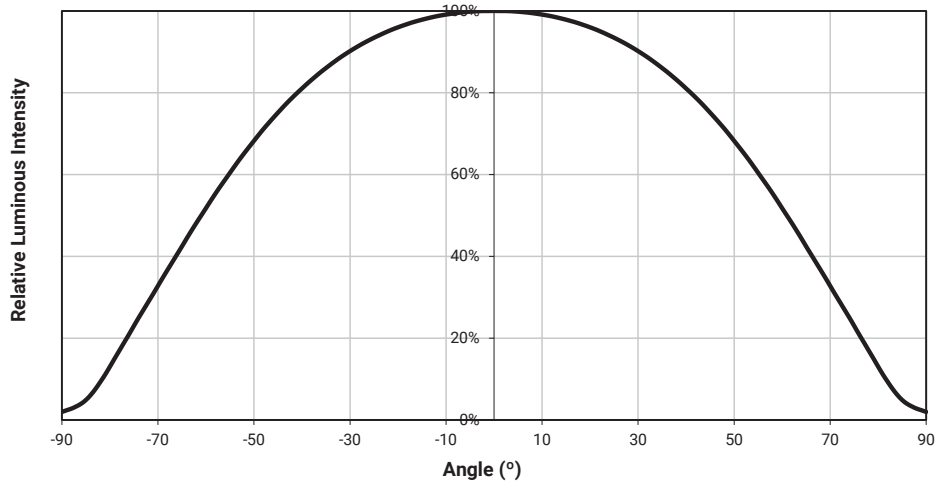

THERMAL DESIGN

The maximum forward current is determined by the thermal resistance between the LED junction and ambient. It is crucial for the end product to be designed in a manner that minimizes the thermal resistance from the solder point to ambient in order to optimize lamp life and optical characteristics.

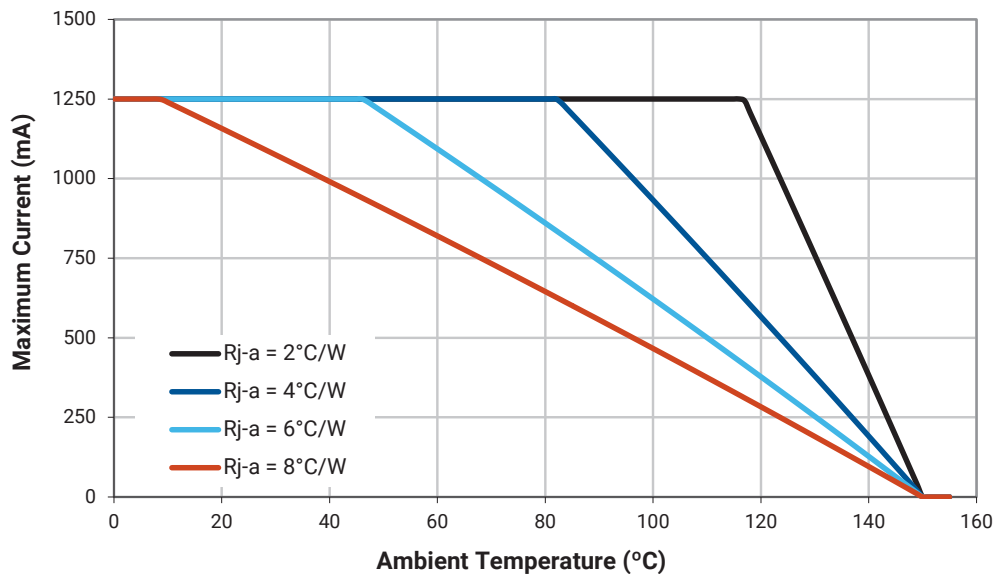

PERFORMANCE GROUPS - LUMINOUS FLUX ($T_j = 85\text{ }^\circ\text{C}$)

XLamp MK-R LEDs are tested for luminous flux and placed into one of the following bins.

Group Code	Minimum Luminous Flux	Maximum Luminous Flux
D2	510	550
D4	550	590
E2	590	635
E4	635	680
F2	680	730
F4	730	780
G2	780	840
G4	840	900
H2	900	970
H4	970	1040
J2	1040	1120
J4	1120	1200
K2	1200	1290

PERFORMANCE GROUPS - CHROMATICITY ($T_J = 85\text{ }^\circ\text{C}$)

XLamp MK-R LEDs are tested for chromaticity and placed into one of the regions defined by the following bounding coordinates.

EasyWhite Color Temperatures – 4-Step			
Code	CCT	x	y
50H	5000 K	0.3407	0.3459
		0.3415	0.3586
		0.3499	0.3654
		0.3484	0.3521
45H	4500 K	0.3674	0.3772
		0.3582	0.3710
		0.3562	0.3573
		0.3642	0.3625
40H	4000 K	0.3744	0.3685
		0.3782	0.3837
		0.3912	0.3917
		0.3863	0.3758
35H	3500 K	0.3981	0.3800
		0.4040	0.3966
		0.4186	0.4037
		0.4116	0.3865
30H	3000 K	0.4242	0.3919
		0.4322	0.4096
		0.4449	0.4141
		0.4359	0.3960
27H	2700 K	0.4475	0.3994
		0.4573	0.4178
		0.4695	0.4207
		0.4589	0.4021

EasyWhite Color Temperatures – 2-Step			
Code	CCT	x	y
50F	5000 K	0.3429	0.3507
		0.3434	0.3571
		0.3475	0.3604
		0.3469	0.3539
45F	4500 K	0.3643	0.3720
		0.3597	0.3689
		0.3587	0.3620
		0.3628	0.3647
40F	4000 K	0.3784	0.3741
		0.3804	0.3818
		0.3867	0.3857
		0.3844	0.3778
35F	3500 K	0.4030	0.3857
		0.4061	0.3941
		0.4132	0.3976
		0.4099	0.3890
30F	3000 K	0.4291	0.3973
		0.4333	0.4062
		0.4395	0.4084
		0.4351	0.3994
27F	2700 K	0.4528	0.4046
		0.4578	0.4138
		0.4638	0.4152
		0.4586	0.4060

PERFORMANCE GROUPS - CHROMATICITY (T_J = 85 °C) - CONTINUED

ANSI White Bins													
Code	CCT	Bin Code	x	y	Bin Code	x	y	Bin Code	x	y	Bin Code	x	y
051	6200 K	0A0	0.2920	0.3060	0R0	0.2950	0.2970	1A0	0.3048	0.3207	1R0	0.3068	0.3113
			0.2984	0.3133		0.3009	0.3042		0.3130	0.3290		0.3144	0.3186
			0.3009	0.3042		0.3037	0.2937		0.3144	0.3186		0.3161	0.3059
			0.2950	0.2970		0.2980	0.2880		0.3068	0.3113		0.3093	0.2993
		0B0	0.2895	0.3135	0S0	0.2870	0.3210	1B0	0.3028	0.3304	1S0	0.3005	0.3415
			0.2962	0.3220		0.2937	0.3312		0.3115	0.3391		0.3099	0.3509
			0.2984	0.3133		0.2962	0.3220		0.3130	0.3290		0.3115	0.3391
			0.2920	0.3060		0.2895	0.3135		0.3048	0.3207		0.3028	0.3304
		0C0	0.2962	0.3220	0T0	0.2937	0.3312	1C0	0.3115	0.3391	1T0	0.3099	0.3509
			0.3028	0.3304		0.3005	0.3415		0.3205	0.3481		0.3196	0.3602
			0.3048	0.3207		0.3028	0.3304		0.3213	0.3373		0.3205	0.3481
			0.2984	0.3133		0.2962	0.3220		0.3130	0.3290		0.3115	0.3391
		0D0	0.2984	0.3133	0U0	0.3009	0.3042	1D0	0.3130	0.3290	1U0	0.3144	0.3186
			0.3048	0.3207		0.3068	0.3113		0.3213	0.3373		0.3221	0.3261
			0.3068	0.3113		0.3093	0.2993		0.3221	0.3261		0.3231	0.3120
			0.3009	0.3042		0.3037	0.2937		0.3144	0.3186		0.3161	0.3059

ANSI White Bins										
Code	CCT	Bin Code	x	y	Bin Code	x	y	Bin Code	x	y
051	6200 K	2A0	0.3215	0.3350	2R0	0.3222	0.3243	3A0	.3371	.3490
			0.3290	0.3417		0.3290	0.3300		.3451	.3554
			0.3290	0.3300		0.3290	0.3180		.3440	.3427
			0.3222	0.3243		0.3231	0.3120		.3366	.3369
		2B0	0.3207	0.3462	2S0	0.3196	0.3602	3B0	.3376	.3616
			0.3290	0.3538		0.3290	0.3690		.3463	.3687
			0.3290	0.3417		0.3290	0.3538		.3451	.3554
			0.3215	0.3350		0.3207	0.3462		.3371	.3490
		2C0	0.3290	0.3538	2T0	0.3290	0.3690	3C0	.3463	.3687
			0.3376	0.3616		0.3381	0.3762		.3551	.3760
			0.3371	0.3490		0.3376	0.3616		.3533	.3620
			0.3290	0.3417		0.3290	0.3538		.3451	.3554
		2D0	0.3290	0.3417	2U0	0.3290	0.3300	3D0	.3451	.3554
			0.3371	0.3490		0.3366	0.3369		.3533	.3620
			0.3366	0.3369		0.3361	0.3245		.3515	.3487
			0.3290	0.3300		0.3290	0.3180		.3440	.3427

PERFORMANCE GROUPS - CHROMATICITY (T_J = 85 °C) - CONTINUED

ANSI White Bins				
Code	CCT	Bin Code	x	y
0E1	6500 K	1A0	0.3048	0.3207
			0.3130	0.3290
			0.3144	0.3186
			0.3068	0.3113
		1B0	0.3028	0.3304
			0.3115	0.3391
			0.3130	0.3290
			0.3048	0.3207
		1C0	0.3115	0.3391
			0.3205	0.3481
			0.3213	0.3373
			0.3130	0.3290
		1D0	0.3130	0.3290
			0.3213	0.3373
			0.3221	0.3261
			0.3144	0.3186

ANSI White Bins				
Code	CCT	Bin Code	x	y
0E2	5700 K	2A0	0.3215	0.3350
			0.3290	0.3417
			0.3290	0.3300
			0.3222	0.3243
		2B0	0.3207	0.3462
			0.3290	0.3538
			0.3290	0.3417
			0.3215	0.3350
		2C0	0.3290	0.3538
			0.3376	0.3616
			0.3371	0.3490
			0.3290	0.3417
		2D0	0.3290	0.3417
			0.3371	0.3490
			0.3366	0.3369
			0.3290	0.3300

ANSI White Bins				
Code	CCT	Bin Code	x	y
0E3	5000 K	3A0	.3371	.3490
			.3451	.3554
			.3440	.3427
			.3366	.3369
		3B0	.3376	.3616
			.3463	.3687
			.3451	.3554
			.3371	.3490
		3C0	.3463	.3687
			.3551	.3760
			.3533	.3620
			.3451	.3554
		3D0	.3451	.3554
			.3533	.3620
			.3515	.3487
			.3440	.3427

ANSI White Bins				
Code	CCT	Bin Code	x	y
0E4	4500 K	4A0	.3530	.3597
			.3615	.3659
			.3590	.3521
			.3512	.3465
		4B0	.3548	.3736
			.3641	.3804
			.3615	.3659
			.3530	.3597
		4C0	.3641	.3804
			.3736	.3874
			.3702	.3722
			.3615	.3659
		4D0	.3668	.3957
			.3771	.4034
			.3736	.3874
			.3641	.3804

ANSI White Bins				
Code	CCT	Bin Code	x	y
0E5	4000 K	5A0	.3670	.3578
			.3702	.3722
			.3825	.3798
			.3783	.3646
		5B0	.3702	.3722
			.3736	.3874
			.3869	.3958
			.3825	.3798
		5C0	.3825	.3798
			.3869	.3958
			.4006	.4044
			.3950	.3875
		5D0	.3783	.3646
			.3825	.3798
			.3950	.3875
			.3898	.3716

ANSI White Bins				
Code	CCT	Bin Code	x	y
0E6	3500 K	6A0	.3889	.3690
			.3941	.3848
			.4080	.3916
			.4017	.3751
		6B0	.3941	.3848
			.3996	.4015
			.4146	.4089
			.4080	.3916
		6C0	.4080	.3916
			.4146	.4089
			.4299	.4165
			.4221	.3984
		6D0	.4017	.3751
			.4080	.3916
			.4221	.3984
			.4147	.3814

PERFORMANCE GROUPS - CHROMATICITY ($T_j = 85\text{ }^\circ\text{C}$) - CONTINUED

ANSI White Bins				
Code	CCT	Bin Code	x	y
0E7	3000 K	7A0	.4147	.3814
			.4221	.3984
			.4342	.4028
			.4259	.3853
		7B0	.4221	.3984
			.4299	.4165
			.4430	.4212
			.4342	.4028
		7C0	.4342	.4028
			.4430	.4212
			.4562	.4260
			.4465	.4071
		7D0	.4259	.3853
			.4342	.4028
			.4465	.4071
			.4373	.3893

ANSI White Bins				
Code	CCT	Bin Code	x	y
0E8	2700 K	8A0	.4373	.3893
			.4465	.4071
			.4582	.4099
			.4483	.3919
		8B0	.4465	.4071
			.4562	.4260
			.4687	.4289
			.4582	.4099
		8C0	.4582	.4099
			.4687	.4289
			.4813	.4319
			.4700	.4126
		8D0	.4483	.3919
			.4582	.4099
			.4700	.4126
			.4593	.3944

EASYWHITE® BINS PLOTTED ON THE 1931 CIE COLOR SPACE ($T_j = 85^\circ\text{C}$)

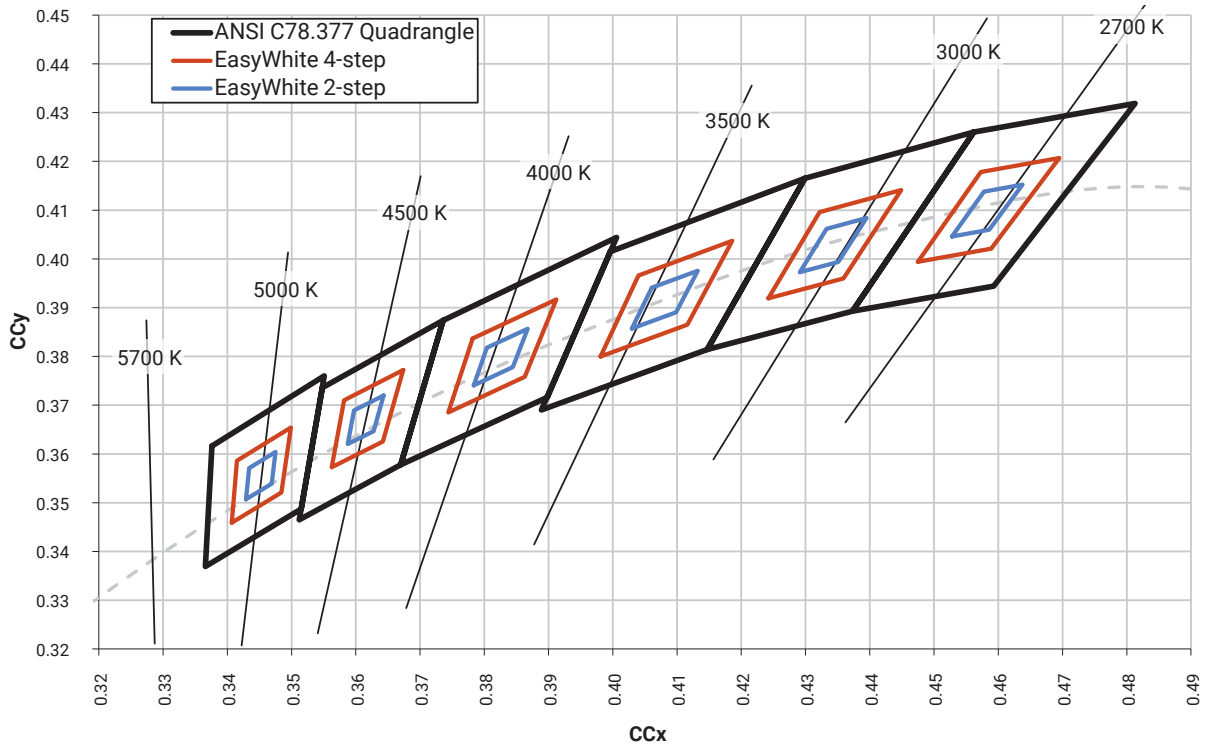

STANDARD COOL WHITE KITS PLOTTED ON ANSI STANDARD CHROMATICITY REGIONS

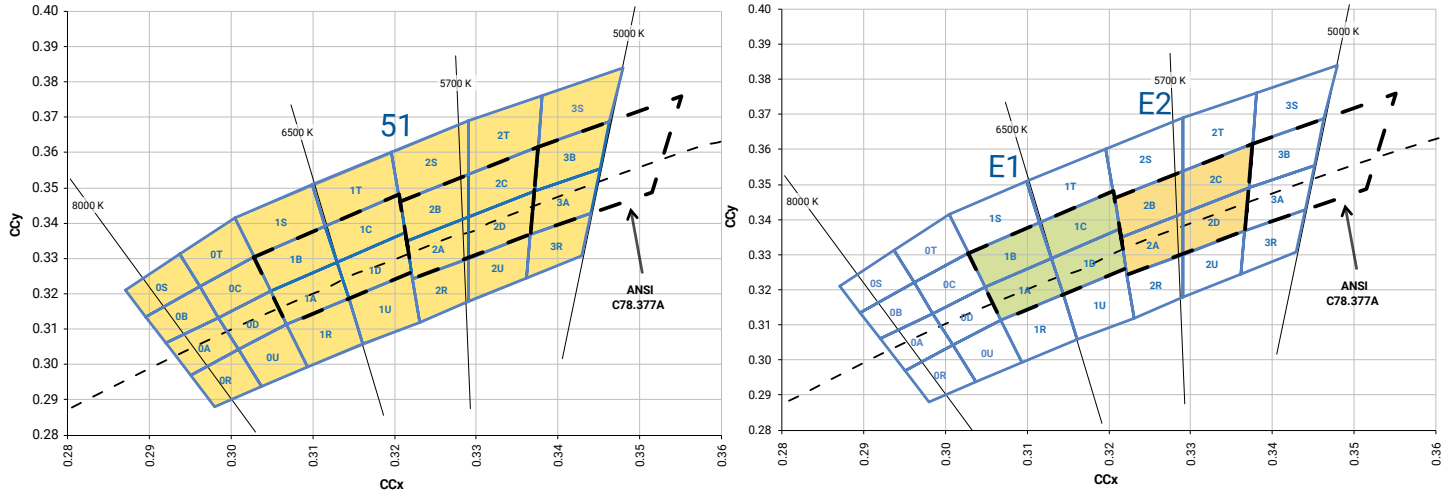

STANDARD WARM AND NEUTRAL WHITE KITS PLOTTED ON ANSI STANDARD CHROMATICITY REGIONS

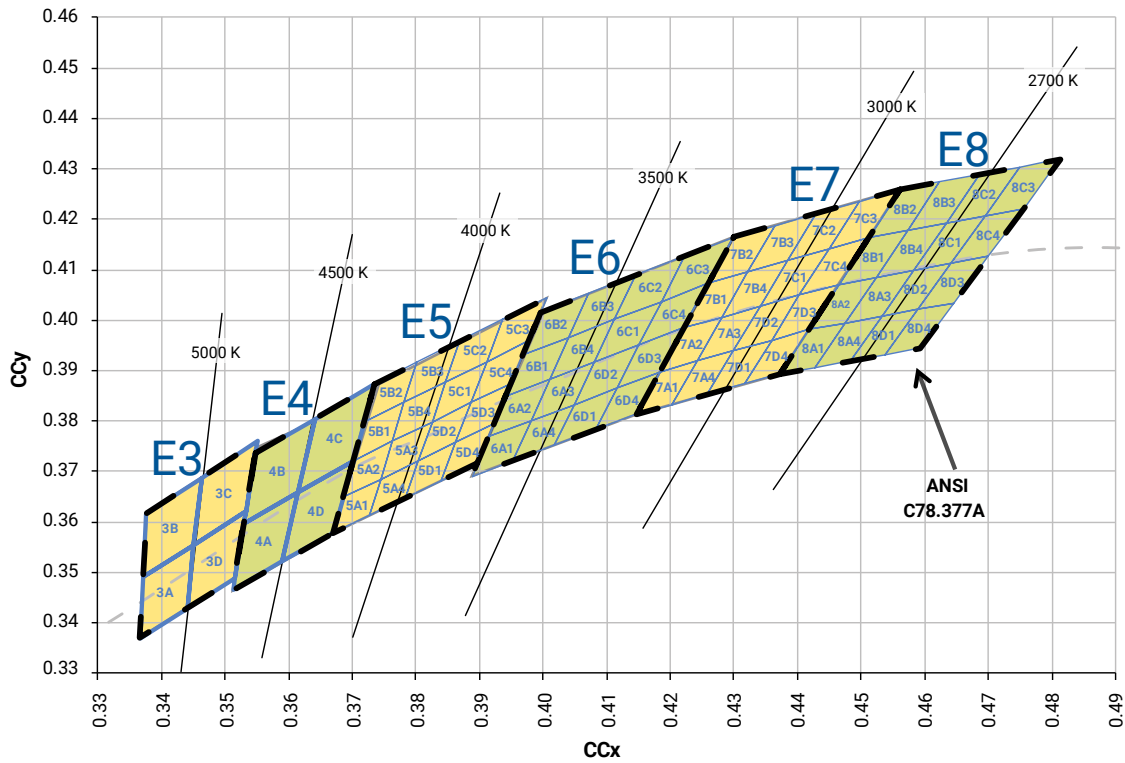

BIN AND ORDER CODE FORMATS

Bin codes and order codes are configured as follows.

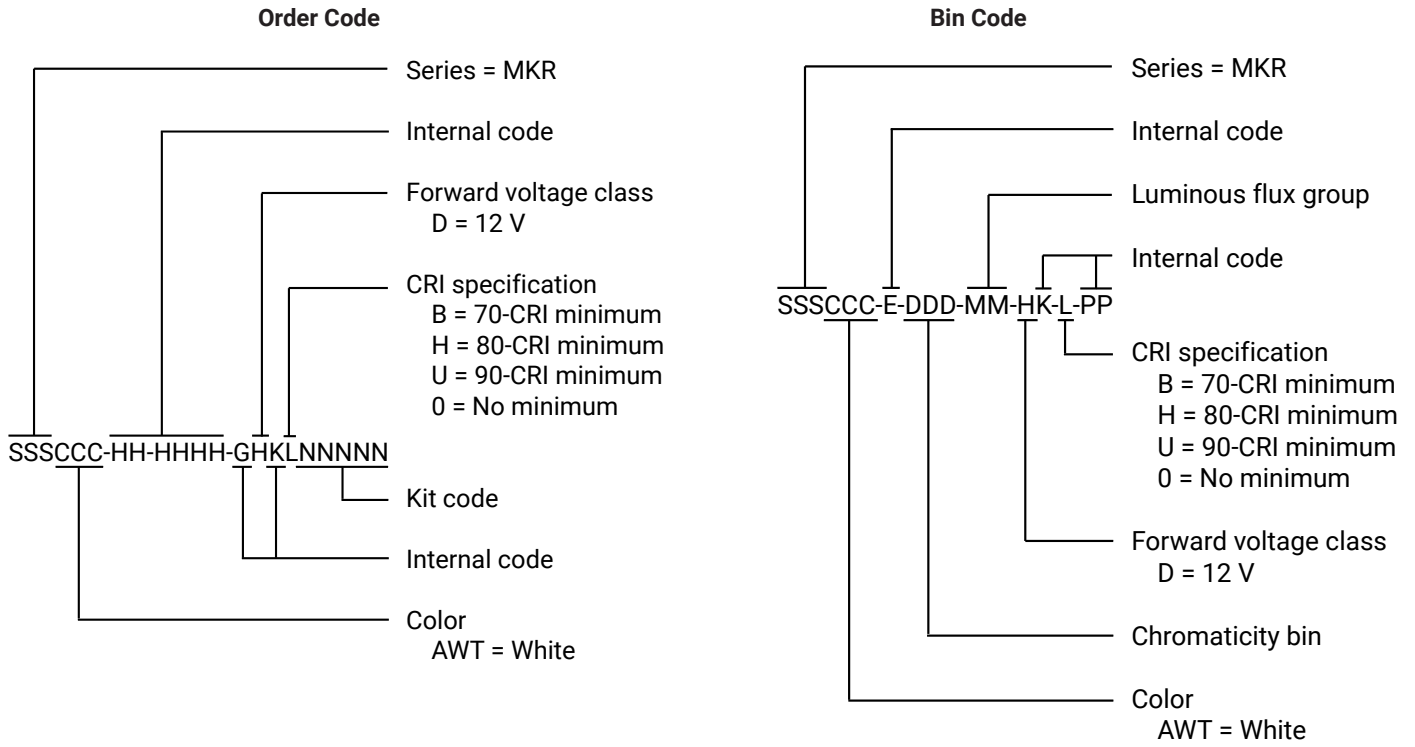

REFLOW SOLDERING CHARACTERISTICS

In testing, Cree LED has found XLamp MK-R LEDs to be compatible with JEDEC J-STD-020C, using the parameters listed below. As a general guideline, Cree LED recommends that users follow the recommended soldering profile provided by the manufacturer of the solder paste used, and therefore it is the lamp or luminaire manufacturer’s responsibility to determine applicable soldering requirements.

Note that this general guideline may not apply to all PCB designs and configurations of reflow soldering equipment.

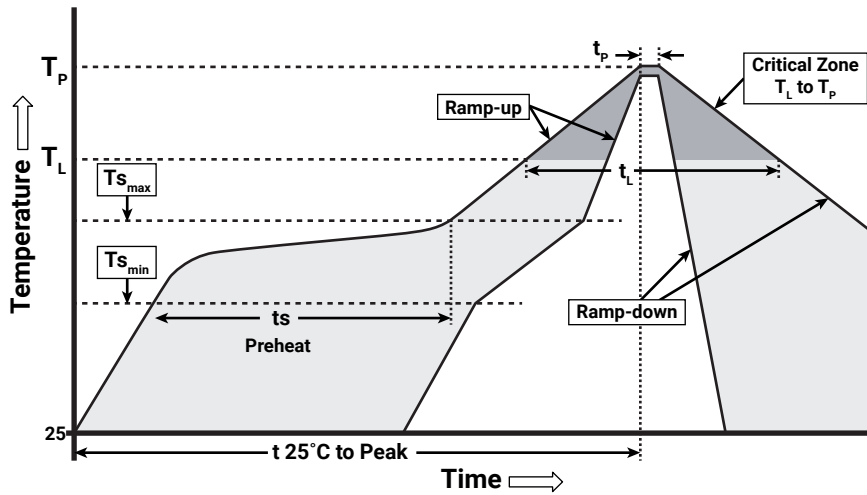

IPC/JEDEC J-STD-020C

Profile Feature	Lead-Free Solder
Average Ramp-Up Rate ($T_{s_{max}}$ to T_p)	1.2 °C/second
Preheat: Temperature Min ($T_{s_{min}}$)	120 °C
Preheat: Temperature Max ($T_{s_{max}}$)	170 °C
Preheat: Time ($t_{s_{min}}$ to $t_{s_{max}}$)	65-150 seconds
Time Maintained Above: Temperature (T_L)	217 °C
Time Maintained Above: Time (t_L)	45-90 seconds
Peak/Classification Temperature (T_p)	235 - 245 °C
Time Within 5 °C of Actual Peak Temperature (t_p)	20-40 seconds
Ramp-Down Rate	1 - 6 °C/second
Time 25 °C to Peak Temperature	4 minutes max.

Note: All temperatures refer to the topside of the package, measured on the package body surface.

NOTES

Measurements

The luminous flux, radiant power, chromaticity, forward voltage and CRI measurements in this document are binning specifications only and solely represent product measurements as of the date of shipment. These measurements will change over time based on a number of factors that are not within Cree LED's control and are not intended or provided as operational specifications for the products. Calculated values are provided for informational purposes only and are not intended or provided as specifications.

Pre-Release Qualification Testing

Please read the [LED Reliability Overview](#) for details of the qualification process Cree LED applies to ensure long-term reliability for XLamp LEDs and details of Cree LED's pre-release qualification testing for XLamp LEDs.

Lumen Maintenance

Cree LED now uses standardized IES LM-80-08 and TM-21-11 methods for collecting long-term data and extrapolating LED lumen maintenance. For information on the specific LM-80 data sets available for this LED, refer to the public [LM-80 results document](#).

Please read the [Long-Term Lumen Maintenance application note](#) for more details on Cree LED's lumen maintenance testing and forecasting. Please read the [Thermal Management application note](#) for details on how thermal design, ambient temperature, and drive current affect the LED junction temperature.

Moisture Sensitivity

Cree LED recommends keeping XLamp LEDs in the provided, resealable moisture-barrier packaging (MBP) until immediately prior to soldering. Unopened MBPs that contain XLamp LEDs do not need special storage for moisture sensitivity.

Once the MBP is opened, XLamp MK-R LEDs may be stored as MSL 1 per JEDEC J-STD-033, meaning they have unlimited floor life in conditions of ≤ 30 °C/85% relative humidity (RH). Regardless of storage condition, Cree LED recommends sealing any unsoldered LEDs in the original MBP.

RoHS Compliance

The levels of RoHS restricted materials in this product are below the maximum concentration values (also referred to as the threshold limits) permitted for such substances, or are used in an exempted application, in accordance with EU Directive 2011/65/EC (RoHS2), as implemented January 2, 2013. RoHS Declarations for this product can be obtained from your Cree LED representative or from the [Product Ecology](#) section of the Cree LED website.

REACH Compliance

REACH substances of very high concern (SVHCs) information is available for this product. Since the European Chemical Agency (ECHA) has published notice of their intent to frequently revise the SVHC listing for the foreseeable future, please contact a Cree LED representative to insure you get the most up-to-date REACH SVHC Declaration. REACH banned substance information (REACH Article 67) is also available upon request.

NOTES - CONTINUED

UL® Recognized Component

This product meets the requirements to be considered a UL Recognized Component with Level 4 enclosure consideration. The LED package or a portion thereof has been investigated as a fire and electrical enclosure per ANSI/UL 8750.

Vision Advisory

WARNING: Do not look at an exposed lamp in operation. Eye injury can result. For more information about LEDs and eye safety, please refer to the [LED Eye Safety application note](#).

MECHANICAL DIMENSIONS

Thermal vias, if present, are not shown on these drawings.

All measurements are $\pm .13$ mm unless otherwise indicated.

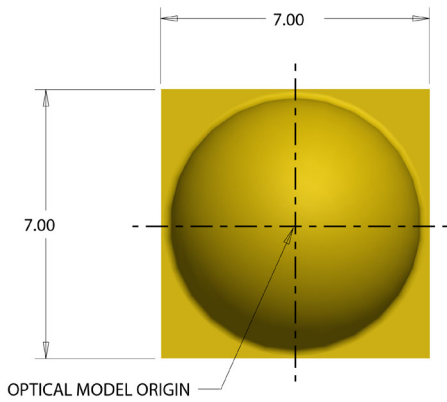

Top View

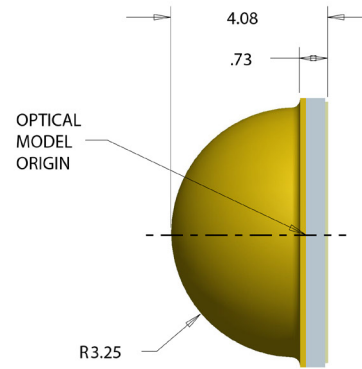

Side View

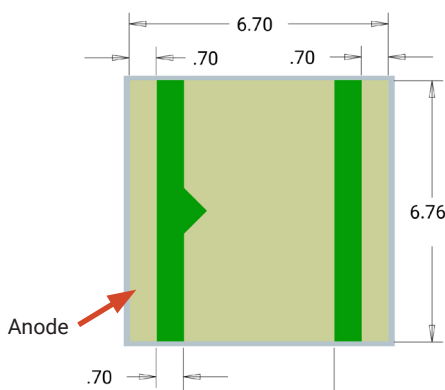

Bottom View

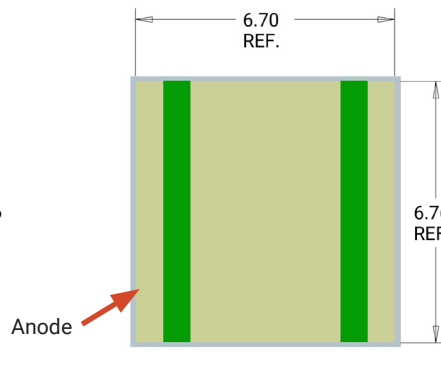

Alternate Bottom View

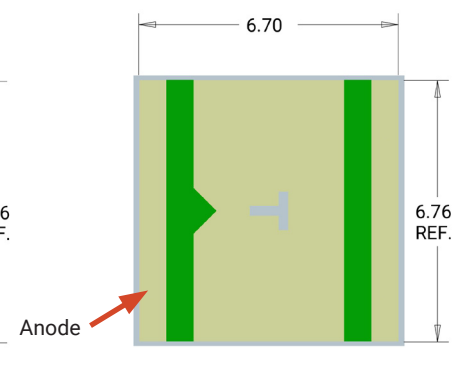

Alternate Bottom View

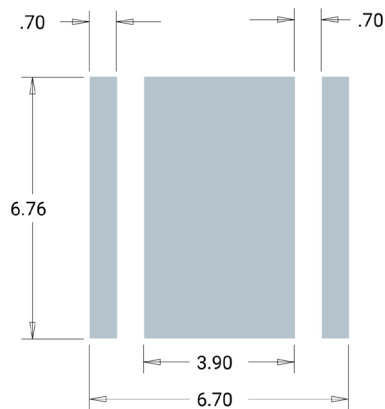

Recommended PCB Solder Pad

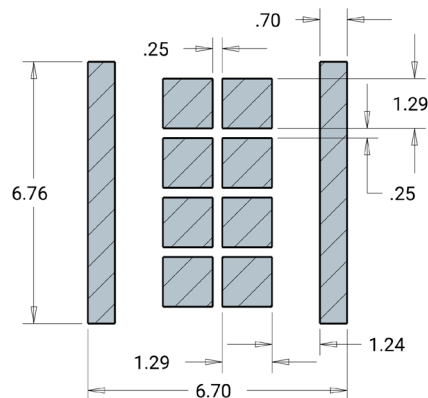

Recommended Stencil Pattern
(Shaded Area Is Open)

TAPE AND REEL

All Cree LED carrier tapes conform to EIA-481D, Automated Component Handling Systems Standard.

All dimensions in mm

All dimensions are ±.13 mm unless otherwise indicated.

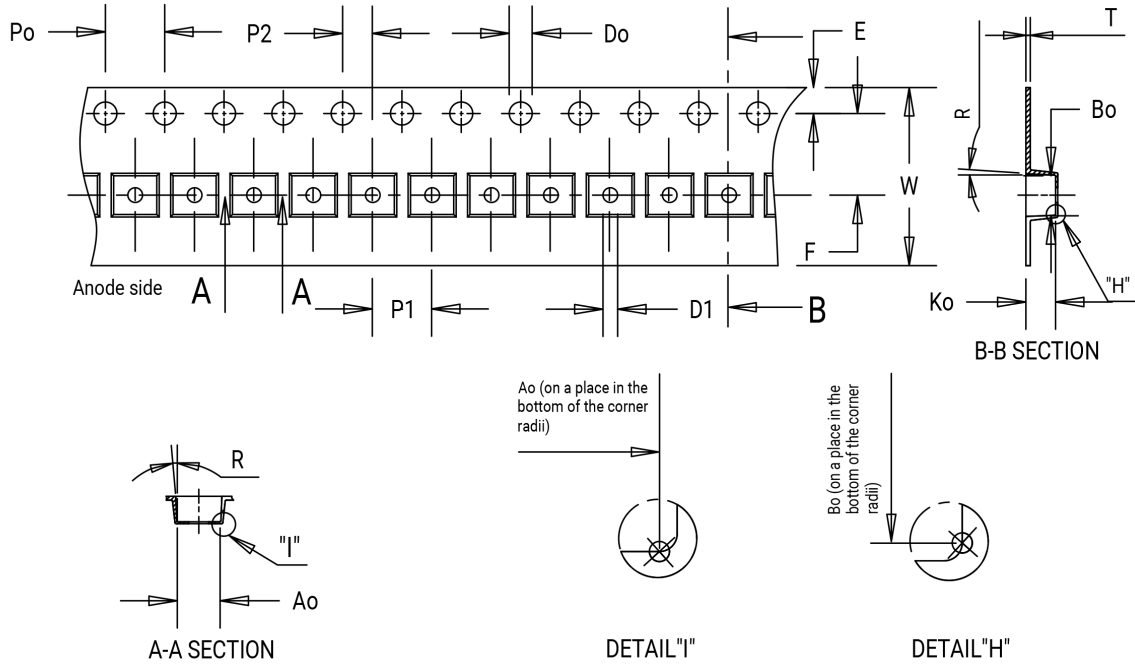

Item	Ao	Bo	Ko	Po	P1	P2	T	E	F	Do	D1	W	R
Dim.	7.40	7.40	4.31	4.00	12.00	2.00	0.36	1.75	7.50	1.50	1.50	16.00	5°

TAPE AND REEL - CONTINUED

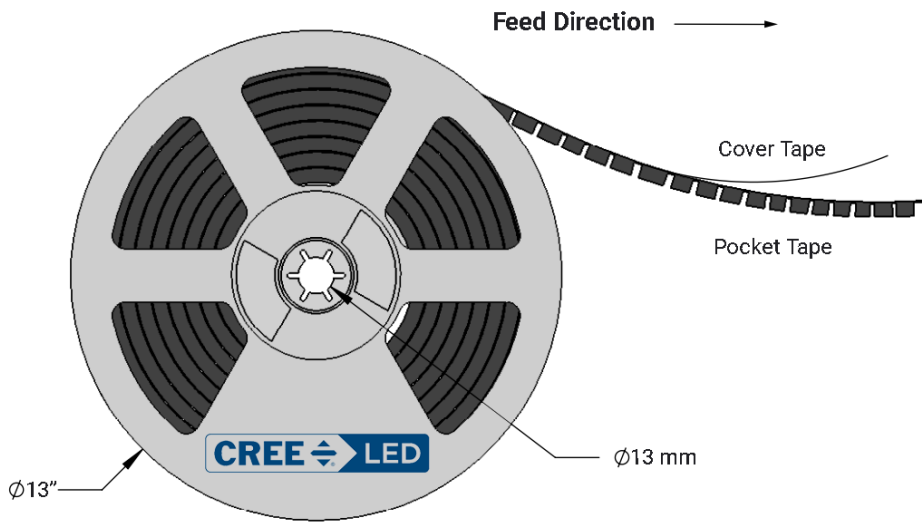
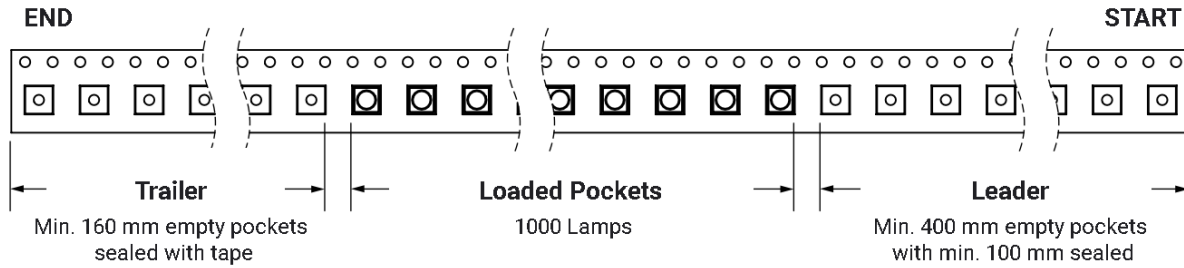

PACKAGING

Unpackaged Reel

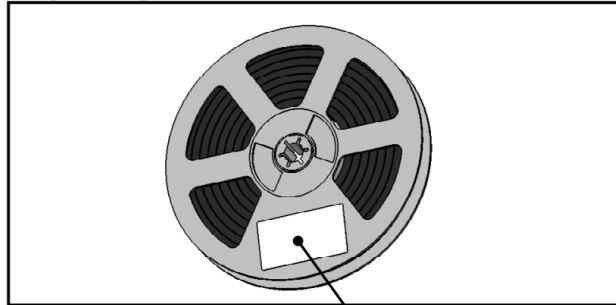

Label with Cree LED Bin Code, Quantity, Reel ID

Packaged Reel

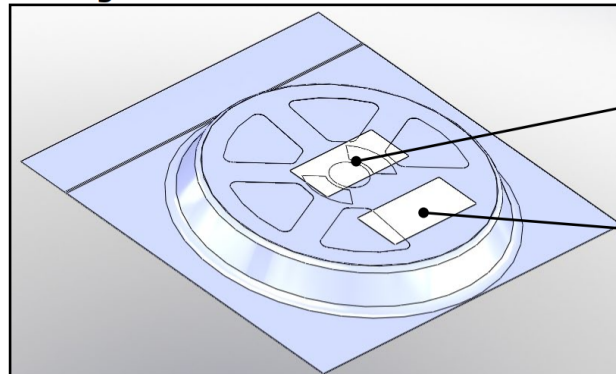

Label with Cree LED Order Code, Quantity, Reel ID, PO#

Label with Cree LED Bin Code, Quantity, Reel ID

Boxed Reel

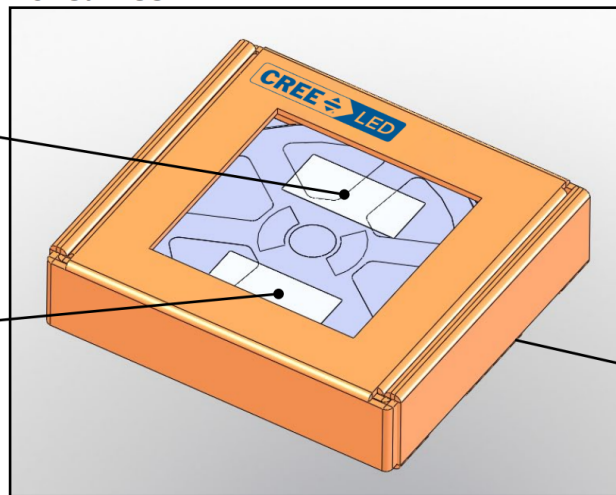

Label with Cree LED Order Code, Quantity, Reel ID, PO#

Label with Cree LED Bin Code, Quantity, Reel ID

Patent Label (on bottom of box)

Looking for pricing, stock, or lifecycle information?

Click below to explore more details on WIN SOURCE:

- ⊖ [View MKRAWT-00-0000-0D0HH40E5 on WIN SOURCE](#)
- ⊖ [Cree Inc. Information](#)

Optimize Your Supply Chain with WIN SOURCE Solutions

- ✓ Global Sourcing Solution
- ✓ Obsolete Management
- ✓ Cost Control Management
- ✓ Shortage Management
- ✓ Alternative Solution
- ✓ Excess Inventory Management