



THE DATASHEET OF IRF6644TRPBF



IR MOSFET

DirectFET™ Power MOSFET ①②

Typical values (unless otherwise specified)

V_{DSS}	V_{GS}	$R_{DS(on)}$ (typ.)
100V min.	± 20V max	10.3mΩ @ 10V
$Q_{g\ tot}$	Q_{gd}	$V_{GS(th)}$
28nC	9.0nC	3.7V

Quality Requirement Category: Consumer

Applications

- RoHS Compliant ①
- Lead-Free (Qualified up to 260°C Reflow)
- Application Specifies MOSFETs
- Ideal for High Performance Isolated Converter Primary Switch Socket
- Optimized for Synchronous Rectification
- Low Conduction Losses
- Low Profile (< 0.7mm)
- Dual Sided Cooling Compatible ①
- Compatible with existing Surface Mount Techniques ①

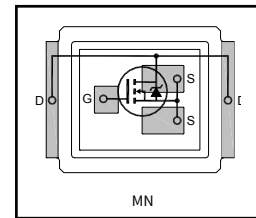

Applicable DirectFET® Outline and Substrate Outline (see pg. 13, 14 for details) ①

SH	SJ	SP		MZ	MN				
----	----	----	--	----	-----------	--	--	--	--

Description

The IRF6644PbF combines the latest HEXFET® Power MOSFET Silicon technology with the advanced DirectFET® packaging to achieve the lowest on-state resistance in a package that has a footprint of a SO-8 and only 0.7 mm profile. The DirectFET® package is compatible with existing layout geometries used in power applications, PCB assembly equipment and vapor phase, infra-red or convection soldering techniques, when application note AN-1035 is followed regarding the manufacturing methods and processes. The DirectFET® package allows dual sided cooling to maximize thermal transfer in power systems improving previous best thermal resistance by 80%.

The IRF6644PbF is optimized for primary side bridge topologies in isolated DC-DC applications, for wide range universal input Telecom applications (36V-75V), and for secondary side synchronous rectification in regulated DC-DC topologies. The reduced total losses in the device coupled with the high level of thermal performance enables high efficiency and low temperatures, which are key for system reliability improvements, and makes the device ideal for high performance isolated DC-DC converters.

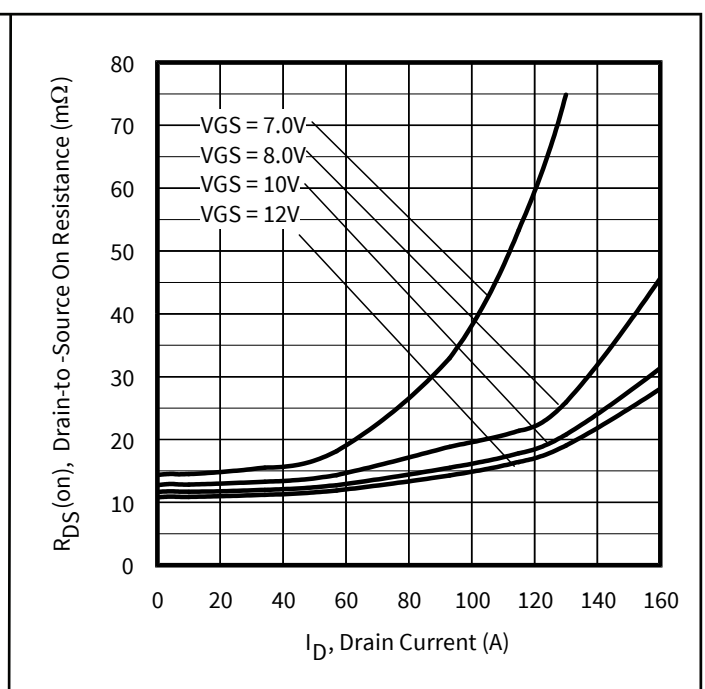
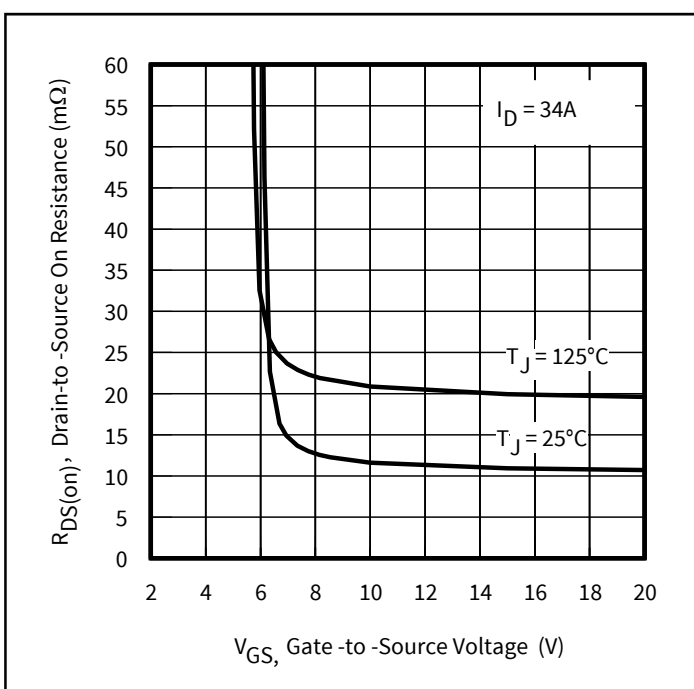

Figure 1 Typical On-Resistance vs. Gate Voltage

Figure 2 Typical On-Resistance vs. Drain Current

Table of Contents

Applications1

Description1

Table of Contents2

1 Parameters3

2 Maximum ratings, Thermal, and Avalanche characteristics4

3 Electrical characteristics5

4 Electrical characteristic diagrams6

Package Information13

Qualification Information16

Revision History17

1 Parameters

Table1 Key performance parameters

Parameter	Values	Units
V_{DS}	100	V
$R_{DS(on) max}$	13	m Ω
$I_D @ T_C @ 25^\circ C$	57	A
$I_D @ T_A @ 25^\circ C$	10	A

2 Maximum ratings and thermal characteristics

Table 2 Maximum ratings (at $T_J=25^\circ\text{C}$, unless otherwise specified)

Parameter	Symbol	Conditions	Values	Unit
Continuous Drain Current (Silicon Limited) ④	I_D	$T_C = 25^\circ\text{C}$, $V_{GS} @ 10\text{V}$	57	A
Continuous Drain Current (Silicon Limited) ④	I_D	$T_C = 70^\circ\text{C}$, $V_{GS} @ 10\text{V}$	46	
Continuous Drain Current (Silicon Limited) ③	I_D	$T_A = 25^\circ\text{C}$, $V_{GS} @ 10\text{V}$	10	
Pulsed Drain Current ⑤	I_{DM}	$T_C = 25^\circ\text{C}$	228	
Maximum Power Dissipation ④	P_D	$T_C = 25^\circ\text{C}$	89	W
Maximum Power Dissipation ④	P_D	$T_C = 70^\circ\text{C}$	57	
Maximum Power Dissipation ③	P_D	$T_A = 25^\circ\text{C}$	2.8	
Gate-to-Source Voltage	V_{GS}	-	± 20	V
Peak Soldering Temperature	T_P	-	270	$^\circ\text{C}$
Operating and Storage Temperature	T_J, T_{STG}	-	-40 ... 150	

Table 3 Thermal characteristics

Parameter	Symbol	Conditions	Min.	Typ.	Max.	Unit
Junction-to-Ambient ③	$R_{\theta JA}$	-	-	-	45	$^\circ\text{C}/\text{W}$
Junction-to-Ambient ⑧	$R_{\theta JA}$	-	-	12.5	-	
Junction-to-Ambient ⑨	$R_{\theta JA}$	-	-	20	-	
Junction-to-Case ④ ⑩	$R_{\theta JC}$	-	-	-	1.4	
Junction-to-PCB Mounted	$R_{\theta JA-PCB}$	-	-	1.0	-	

Table 4 Avalanche characteristics

Parameter	Symbol	Values	Unit
Single Pulse Avalanche Energy ⑥	E_{AS}	86	mJ
Avalanche Current ⑥	I_{AR}	34	A

Notes:

- ① Click on this section to link to the appropriate technical paper.
- ② Click on this section to link to the DirectFET™ Website.
- ③ Surface mounted on 1 in. square Cu board, steady state.
- ④ T_C measured with thermocouple mounted to top (Drain) of part.
- ⑤ Repetitive rating; pulse width limited by max. junction temperature.
- ⑥ (Starting $T_J = 25^\circ\text{C}$, $L = 0.15\text{mH}$, $R_G = 50\Omega$, $I_{AS} = 34\text{A}$.)
- ⑦ Pulse width $\leq 400\mu\text{s}$; duty cycle $\leq 2\%$.
- ⑧ Used double sided cooling, mounting pad with large heat sink.
- ⑨ Mounted on minimum footprint full size board with metalized back and with small clip heat sink.
- ⑩ R_θ is measured at T_J of approximately 90°C .

3 Electrical characteristics

Table 5 Static characteristics

Parameter	Symbol	Conditions	Values			Unit
			Min.	Typ.	Max.	
Drain-to-Source Breakdown Voltage	$V_{(BR)DSS}$	$V_{GS} = 0V, I_D = 250\mu A$	100	-	-	V
Breakdown Voltage Temp. Coefficient	$\Delta V_{(BR)DSS}/\Delta T_J$	Reference to 25°C, $I_D = 1mA$	-	0.1	-	V/°C
Static Drain-to-Source On-Resistance	$R_{DS(on)}$	$V_{GS} = 10V, I_D = 34A$ ⑦	-	10.3	13	mΩ
Gate Threshold Voltage	$V_{GS(th)}$	$V_{DS} = V_{GS}, I_D = 150\mu A$	2.8	3.7	4.8	V
Gate Threshold Voltage Temp. Coefficient	$\Delta V_{GS(th)}/\Delta T_J$		-	-11	-	mV°/C
Drain-to-Source Leakage Current	I_{DSS}	$V_{DS} = 100V, V_{GS} = 0V$	-	-	20	μA
		$V_{DS} = 80V, V_{GS} = 0V, T_J = 125^\circ C$	-	-	250	
Gate-to-Source Forward Leakage	I_{GSS}	$V_{GS} = 20V$	-	-	100	nA
	I_{GSS}	$V_{GS} = -20V$	-	-	-100	
Gate Resistance	R_G	-	-	1.6	-	Ω

Table 6 Dynamic characteristics

Parameter	Symbol	Conditions	Values			Unit	
			Min.	Typ.	Max.		
Forward Trans conductance	gfs	$V_{DS} = 10V, I_D = 34A$	65	-	-	S	
Total Gate Charge	Q_g	$I_D = 34A$ $V_{DS} = 50V$ $V_{GS} = 10V$ See Fig.8	-	28	42	nC	
Pre-Vth Gate-to-Source Charge	Q_{gs1}		-	7.0	-		
Post-Vth Gate-to-Source Charge	Q_{gs2}		-	3.0	-		
Gate-to-Drain Charge	Q_{gd}		-	9.0	-		
Gate Charge Overdrive	Q_{godr}		-	9.0	-		
Switch Charge ($Q_{gs2} + Q_{gd}$)	Q_{sw}		-	16	-		
Output Charge	Q_{oss}	$V_{DS} = 16V, V_{GS} = 0V$	-	18	-	nC	
Turn-On Delay Time	$t_{d(on)}$	$V_{DD} = 50V$ $I_D = 34A$ $R_G = 1.8\Omega$ $V_{GS} = 10V$ ⑦	-	9.5	-	ns	
Rise Time	t_r		-	16	-		
Turn-Off Delay Time	$t_{d(off)}$		-	15	-		
Fall Time	t_f		-	5.7	-		
Input Capacitance	C_{iss}	$V_{GS} = 0V$ $V_{DS} = 50V$ $f = 1.0MHz$	-	1770	-	pF	
Output Capacitance	C_{oss}		-	280	-		
Reverse Transfer Capacitance	C_{rss}		-	60	-		
Output Capacitance	C_{oss}		$V_{GS} = 0V, V_{DS} = 1.0V, f = 1.0MHz$	-	2025		-
Output Capacitance	C_{oss}		$V_{GS} = 0V, V_{DS} = 80V, f = 1.0MHz$	-	245		-

Table 7 Reverse Diode

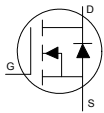
Parameter	Symbol	Conditions	Values			Unit
			Min.	Typ.	Max.	
Continuous Source Current (Body Diode)	I_S	MOSFET symbol showing the integral reverse p-n junction diode. 	-	-	57	A
Pulsed Source Current (Body Diode) ⑤	I_{SM}		-	-	228	
Diode Forward Voltage	V_{SD}	$T_J = 25^\circ C, I_S = 34A, V_{GS} = 0V$ ⑦	-	-	1.3	V
Reverse Recovery Time	t_{rr}	$T_J = 25^\circ C, I_F = 34A, V_{DD} = 50V$ $di/dt = 100A/\mu s$	-	53	80	ns
Reverse Recovery Charge	Q_{rr}		-	97	146	nC

4 Electrical characteristic diagrams

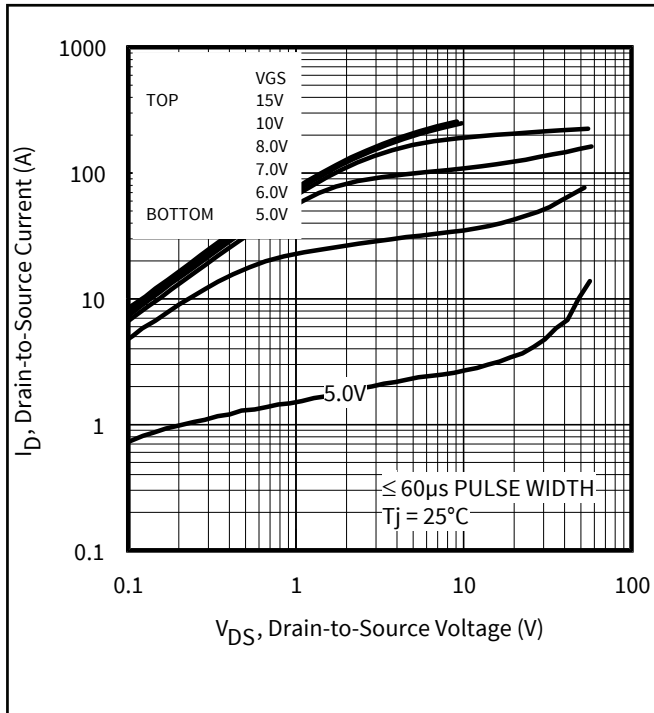

Figure 3 Typical Output Characteristics

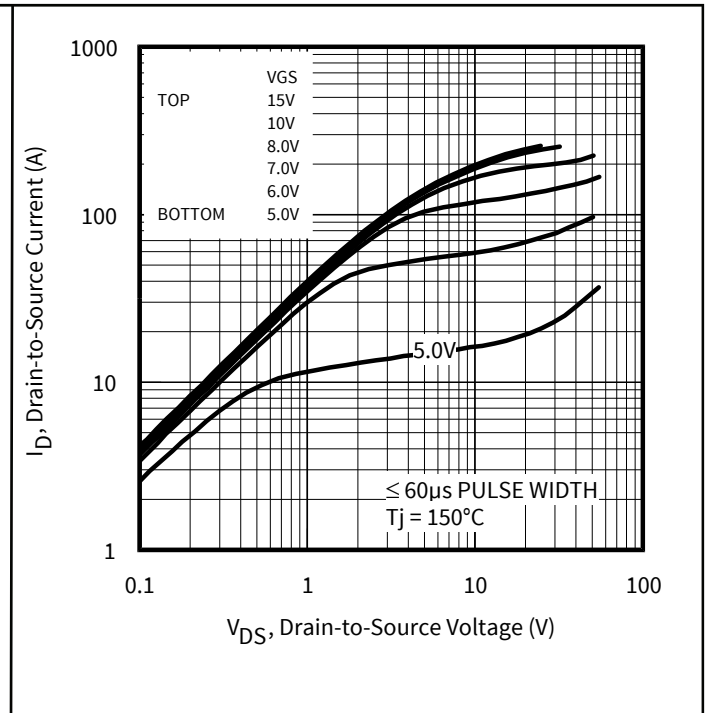

Figure 4 Typical Output Characteristics

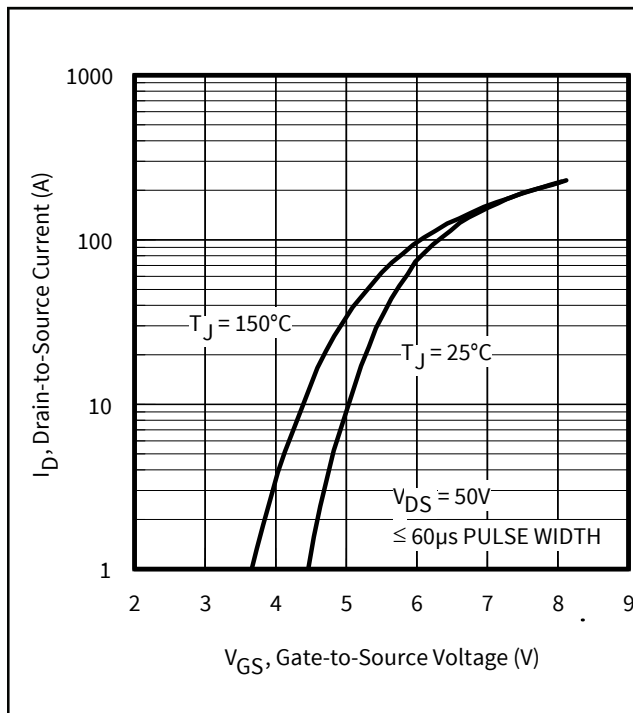

Figure 5 Typical Transfer Characteristics

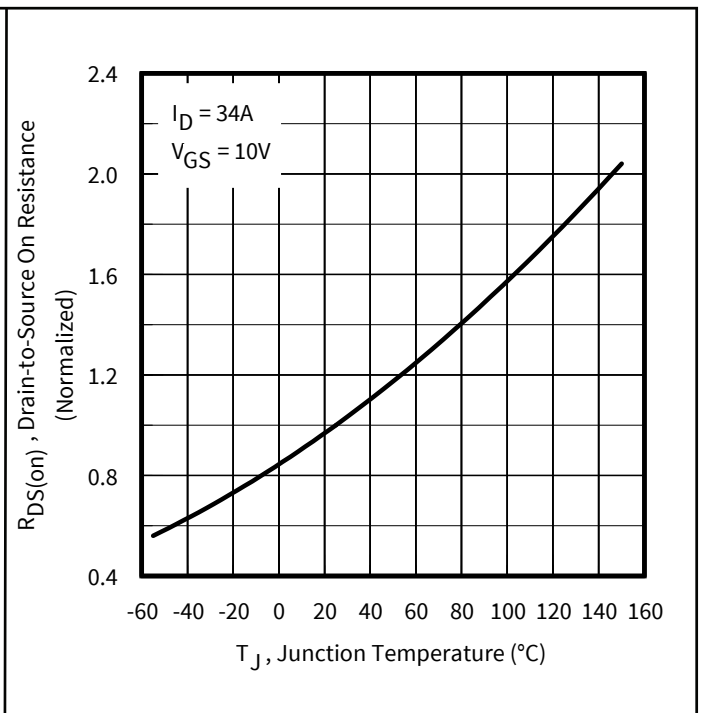

Figure 6 Normalized On-Resistance vs. Temperature

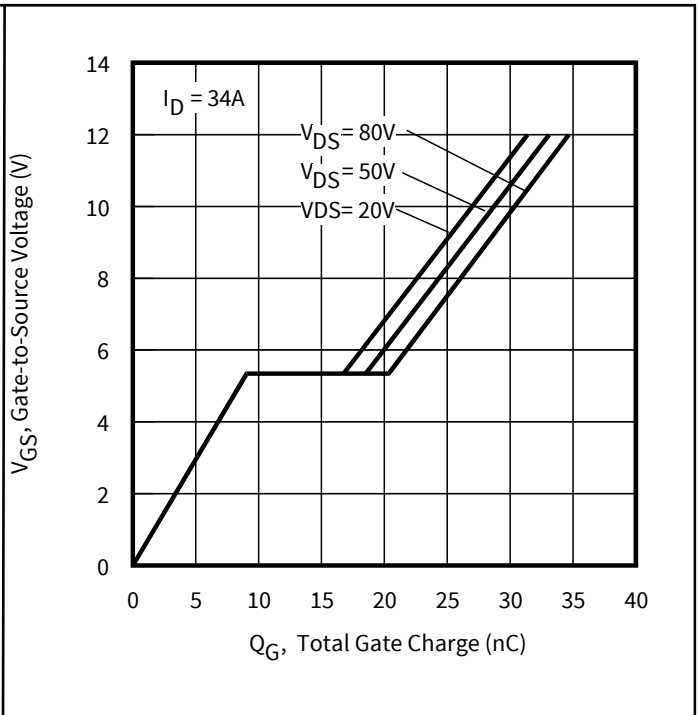
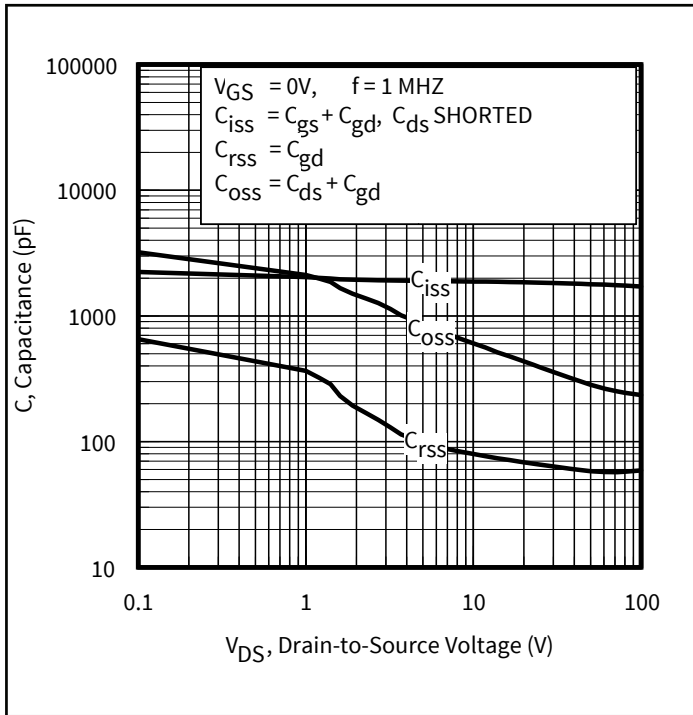

Figure 7 Typical Capacitance vs. Drain-to-Source Voltage

Figure 8 Typical Gate Charge vs. Gate-to-Source Voltage

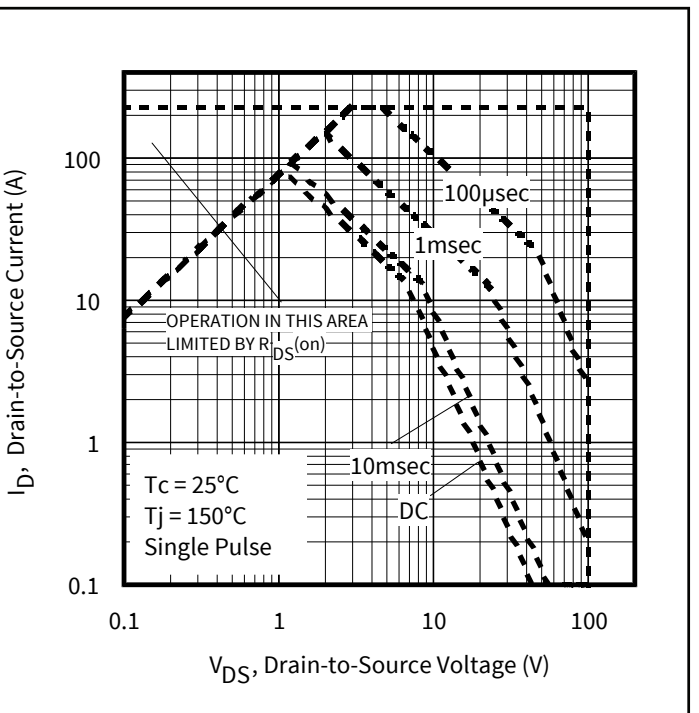
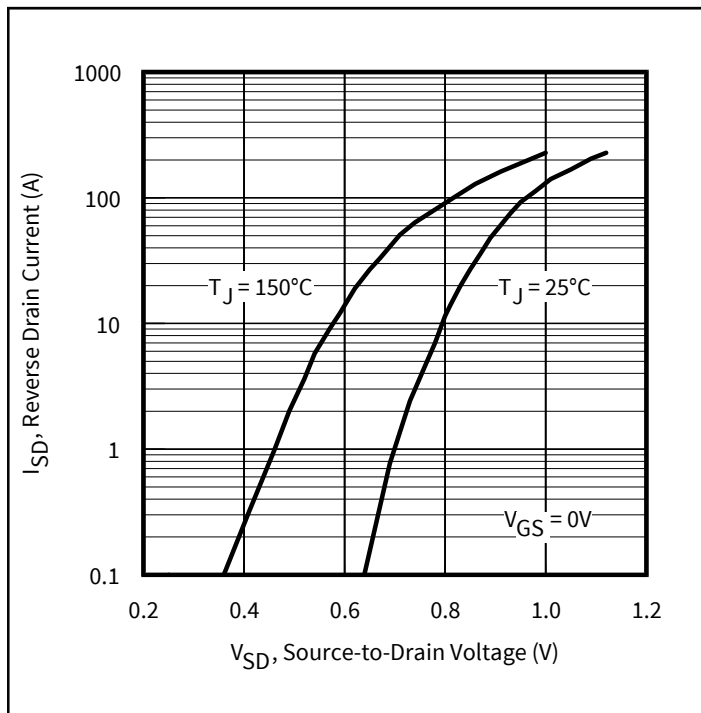

Figure 9 Typical Source-Drain Diode Forward Voltage

Figure 10 Maximum Safe Operating Area

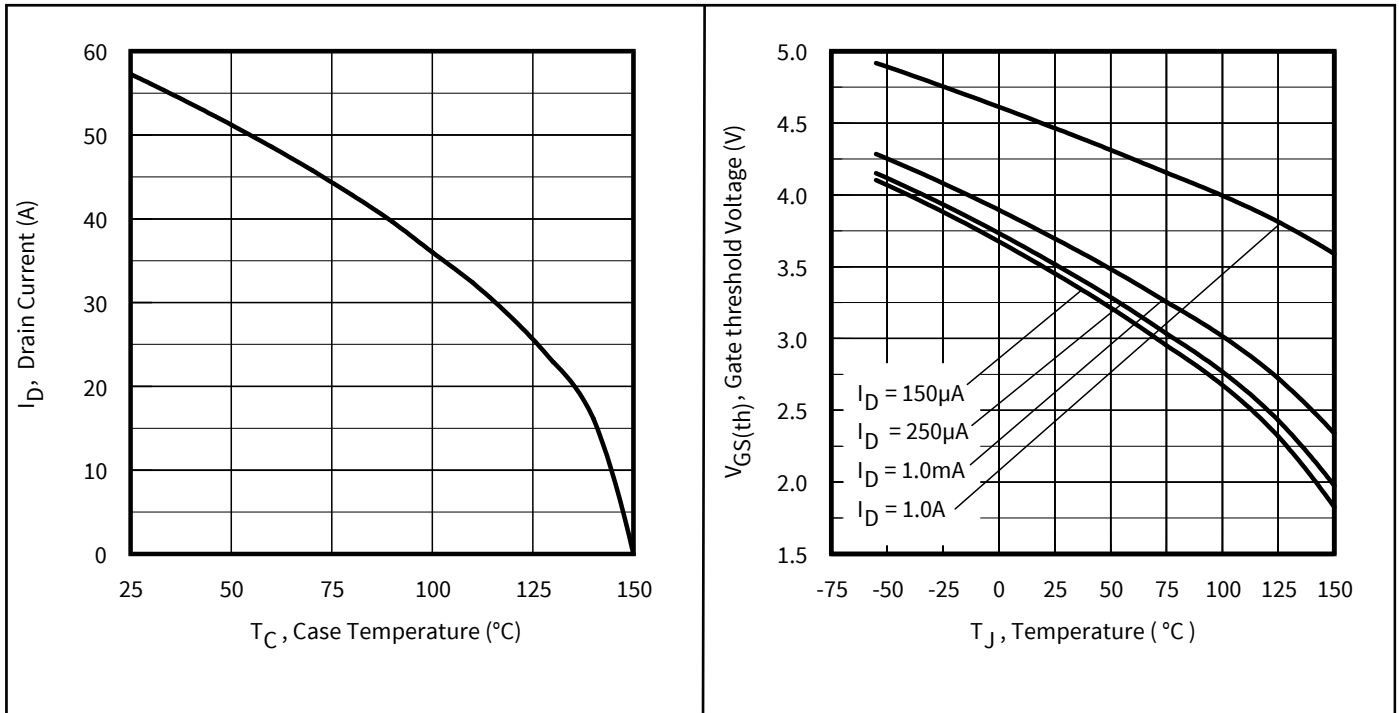

Figure 11 Maximum Drain Current vs. Case Temperature

Figure 12 Typical Threshold Voltage vs. Junction Temperature

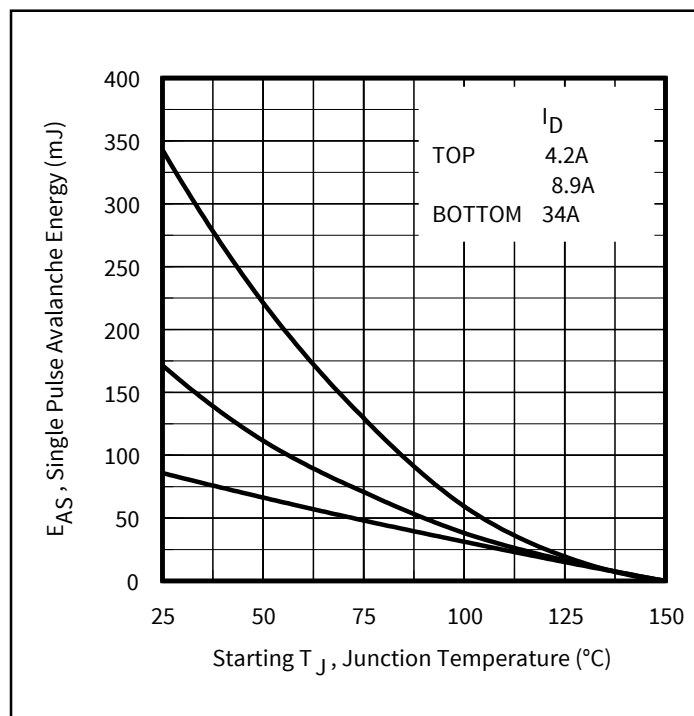

Figure 13 Maximum Avalanche Energy vs. Drain Current

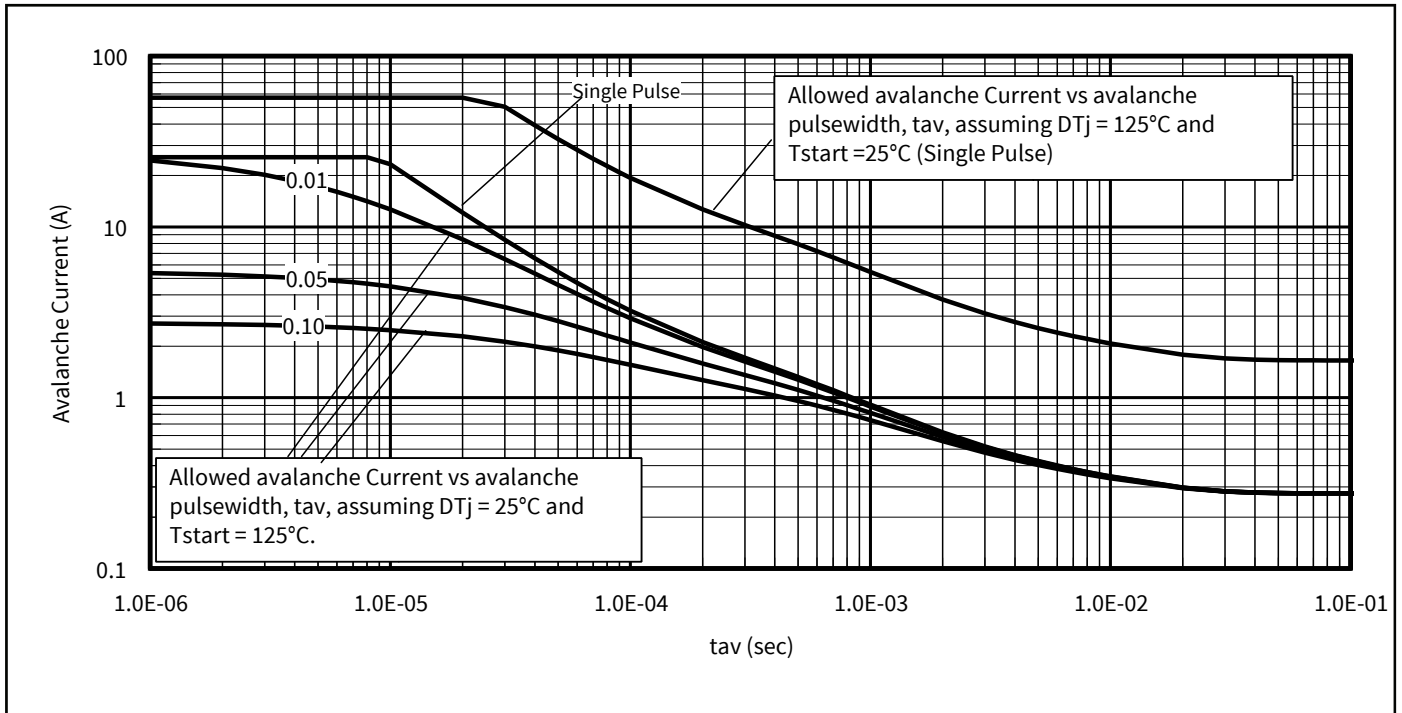

Figure 14 Typical Avalanche Current vs. Pulse Width

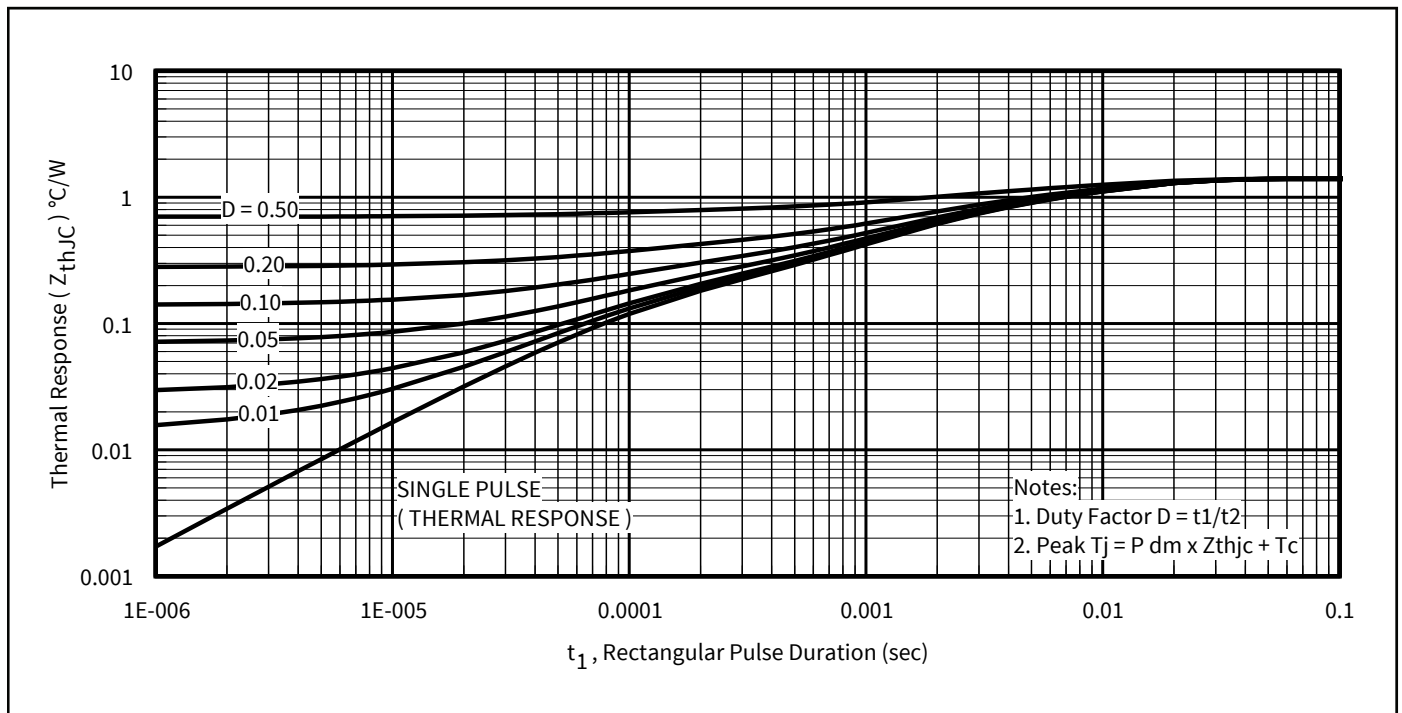

Figure 15 Maximum Effective Transient Thermal Impedance, Junction-to-Case

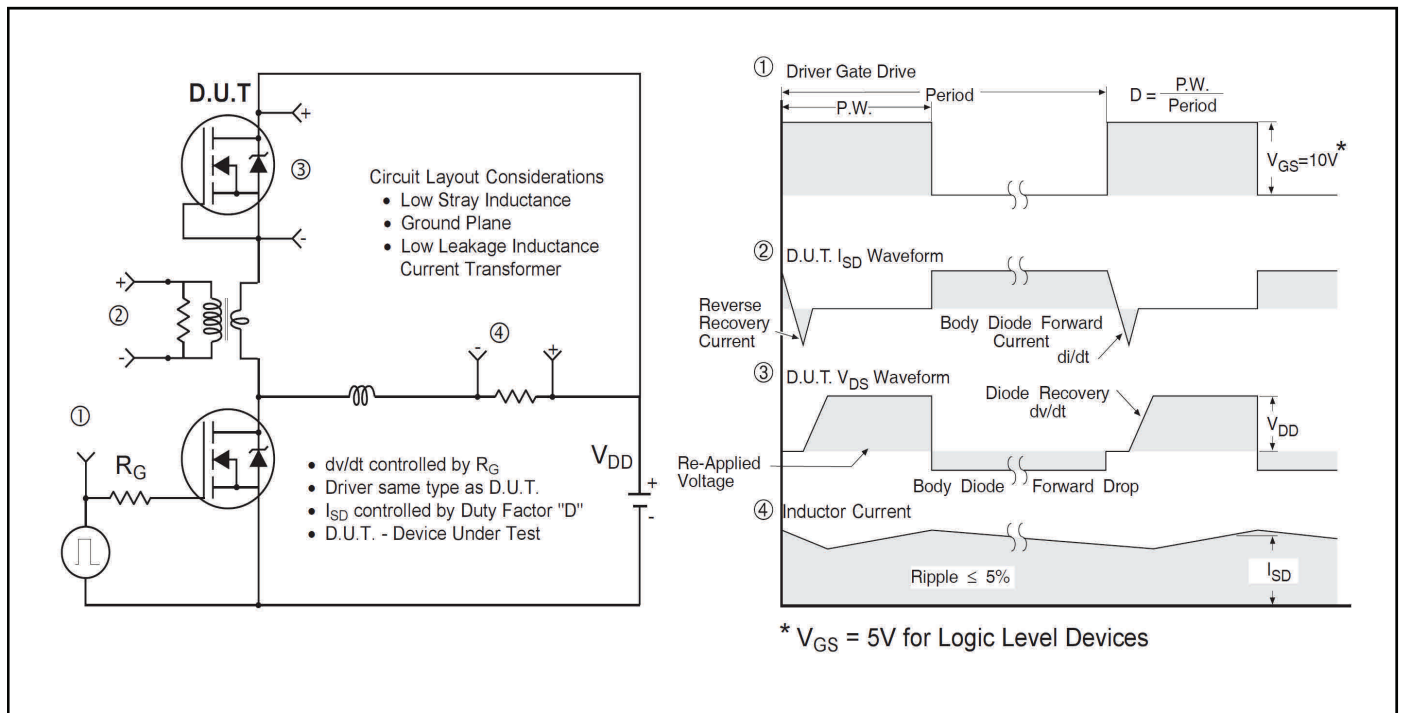
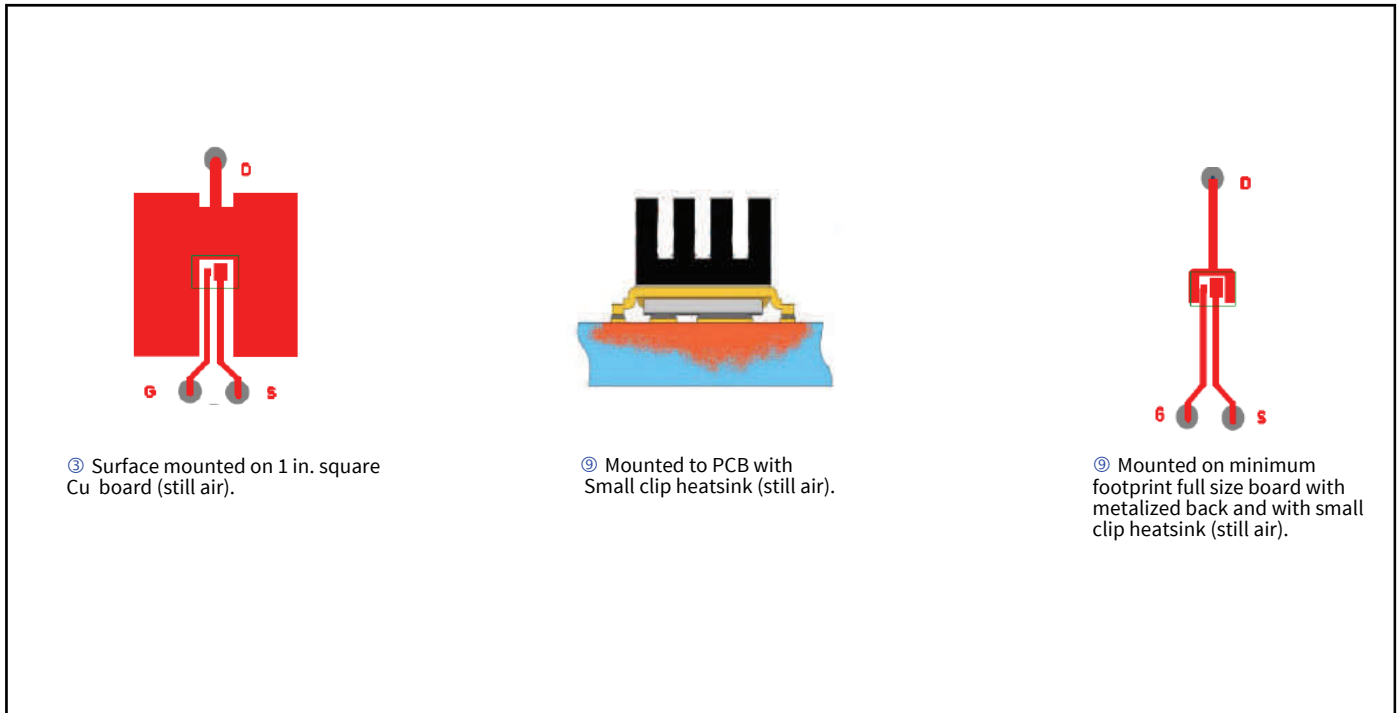

Figure 16 Peak Diode Recovery dv/dt Test Circuit for N-Channel HEXFET™ Power MOSFETs

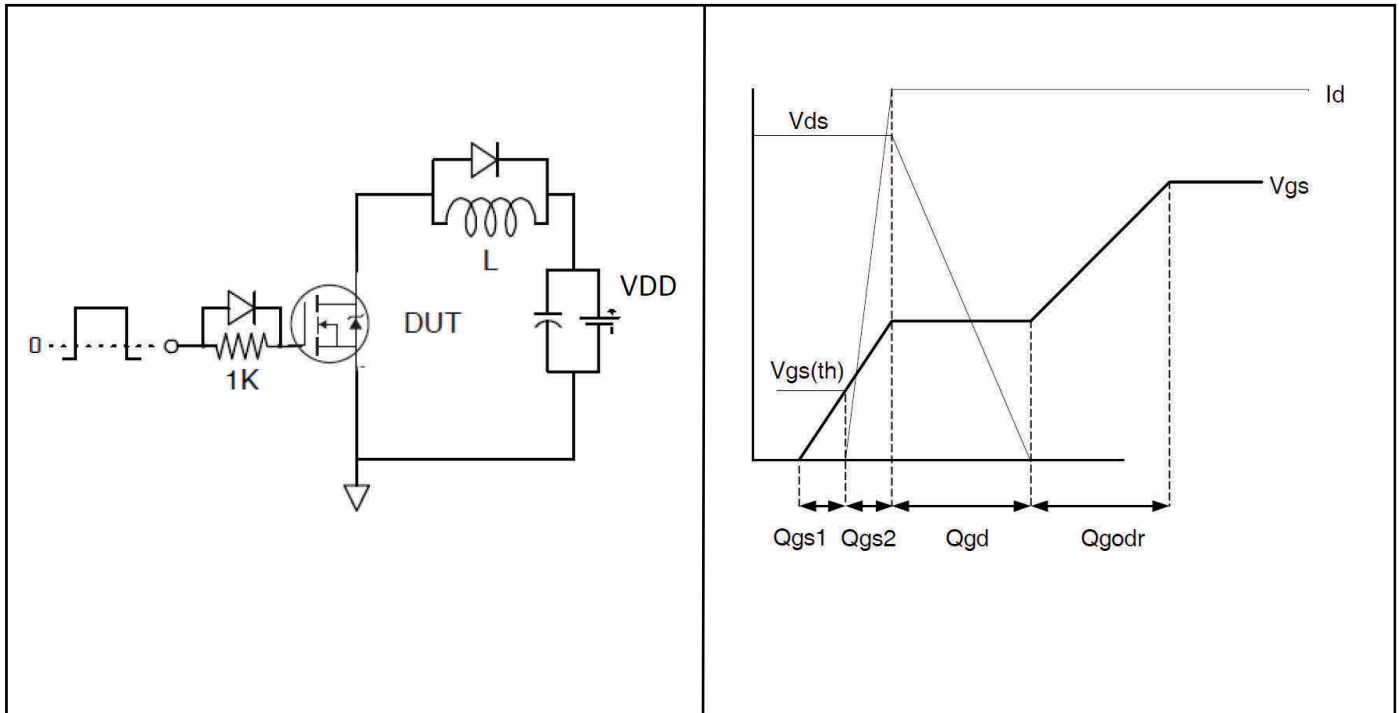

Figure 17a Gate Charge Test Circuit

Figure 17b Gate Charge Waveform

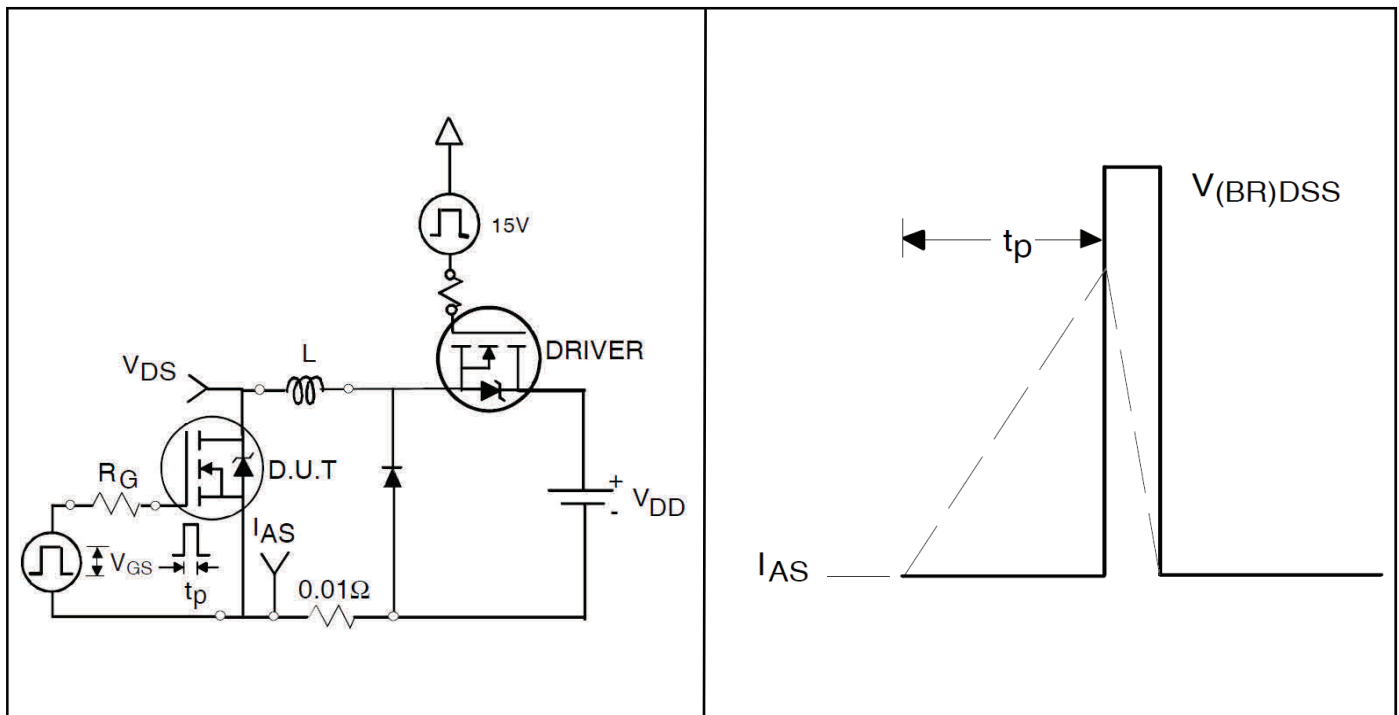

Figure 18a Unclamped Inductive Test Circuit

Figure 18b Unclamped Inductive Waveforms

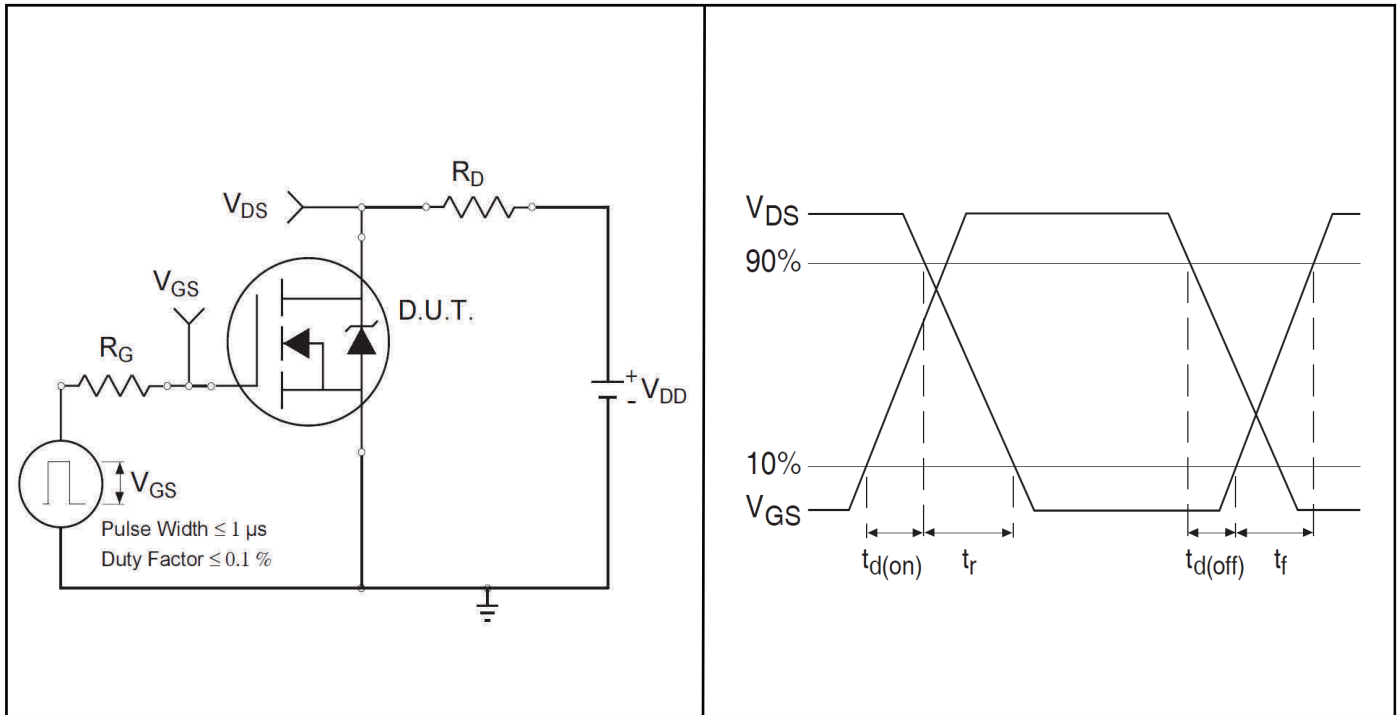

Figure 19a Switching Time Test Circuit

Figure 19b Switching Time Waveforms

5 Package Information

DirectFET™ Board Footprint, MN Outline

Please see DirectFET™ application note [AN-1035](#) for all details regarding the assembly of DirectFET™. This includes all recommendations for stencil and substrate designs.

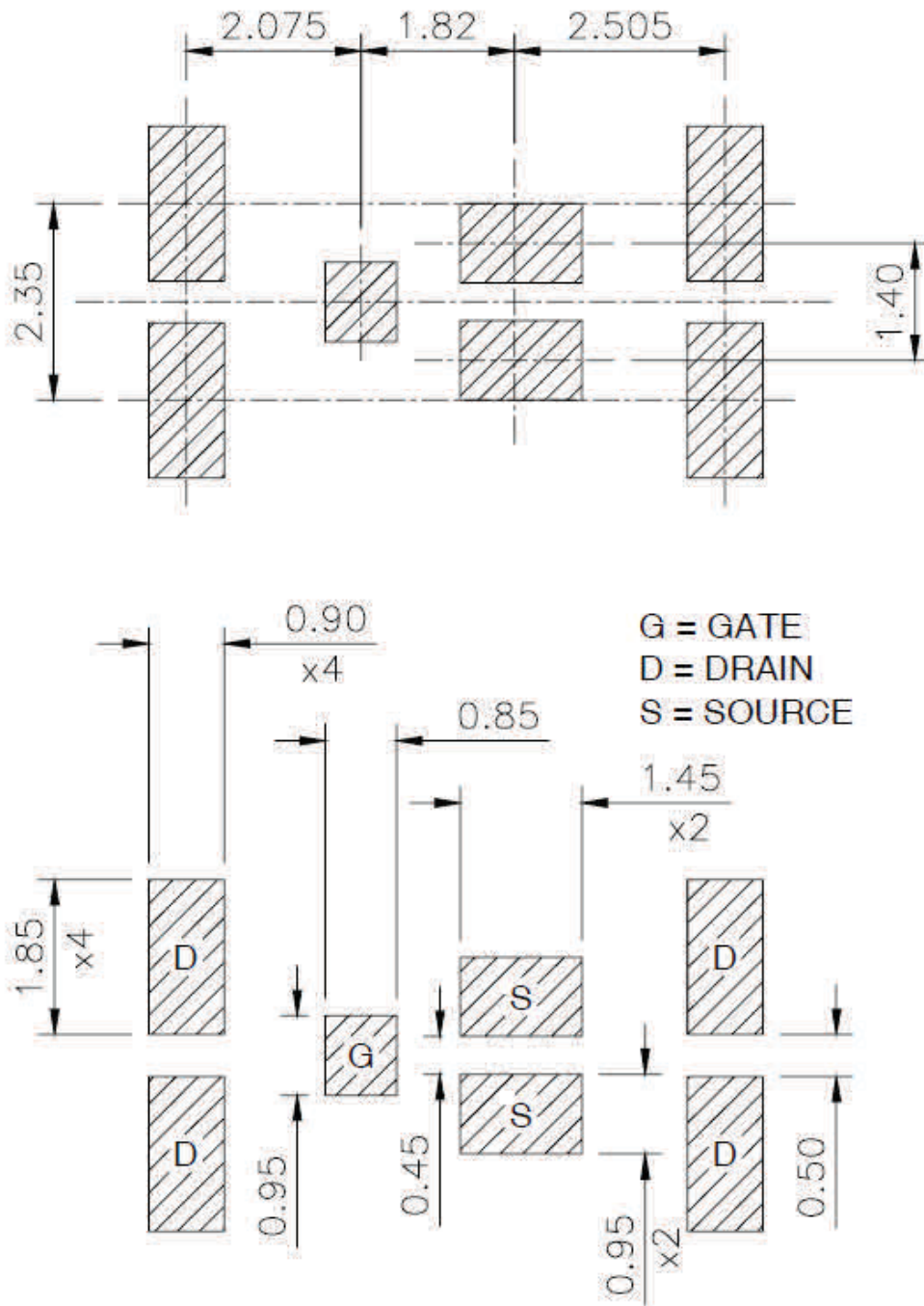

Note: For the most current drawing please refer to website at : www.irf.com/package/

DirectFET™ Outline Dimension, MN Outline (Medium Size Can, N-Designation).

Please see DirectFET™ application note [AN-1035](#) for all details regarding the assembly of DirectFET™. This includes all recommendations for stencil and substrate designs.

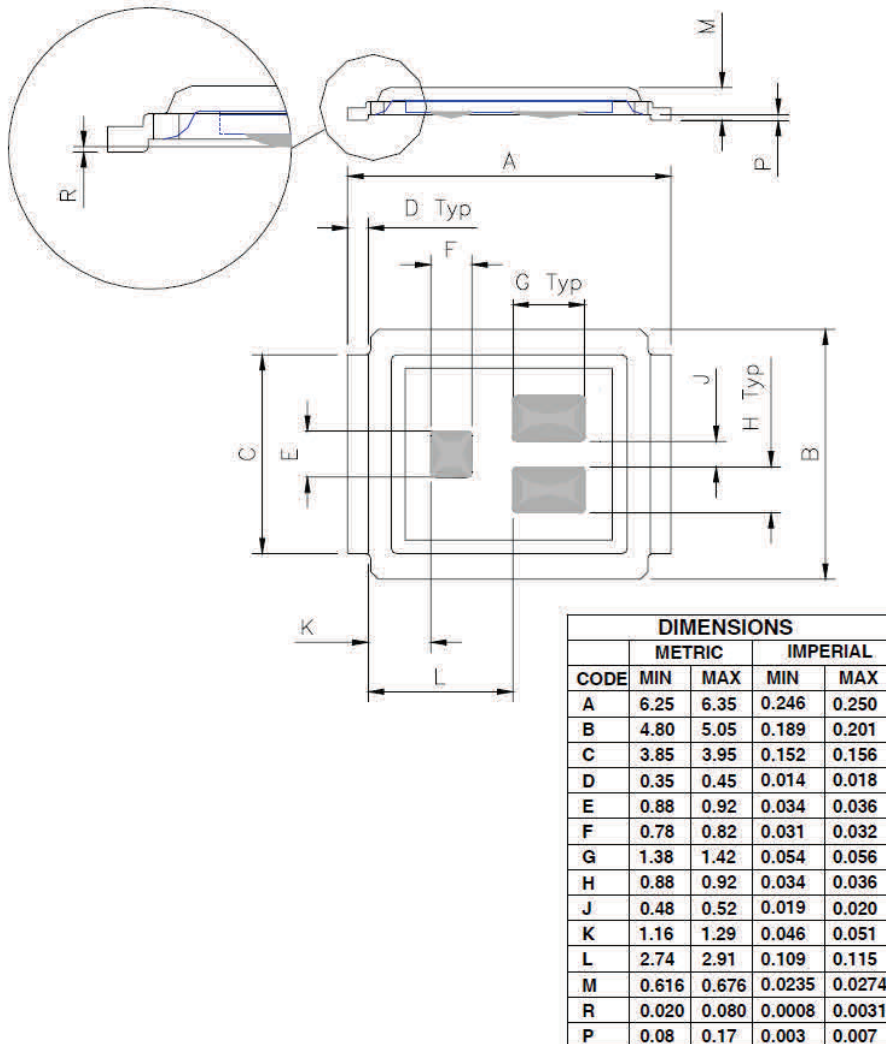

DirectFET™ Part Marking

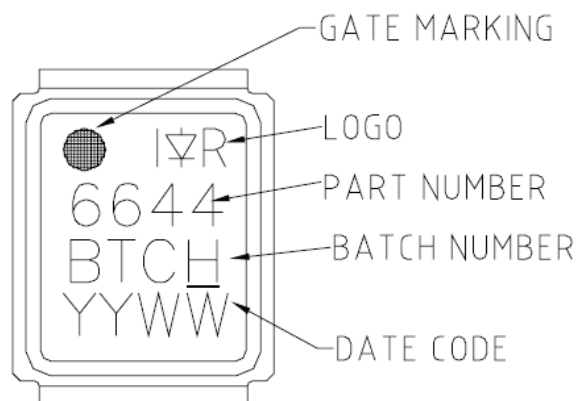

Note: Line above the last character of the date-code indicates "Lead-Free".

Note: For the most current drawing please refer to website at : www.irf.com/package/

Tape & Reel Information

DirectFET™ Tape & Reel Dimension (Showing component orientation).

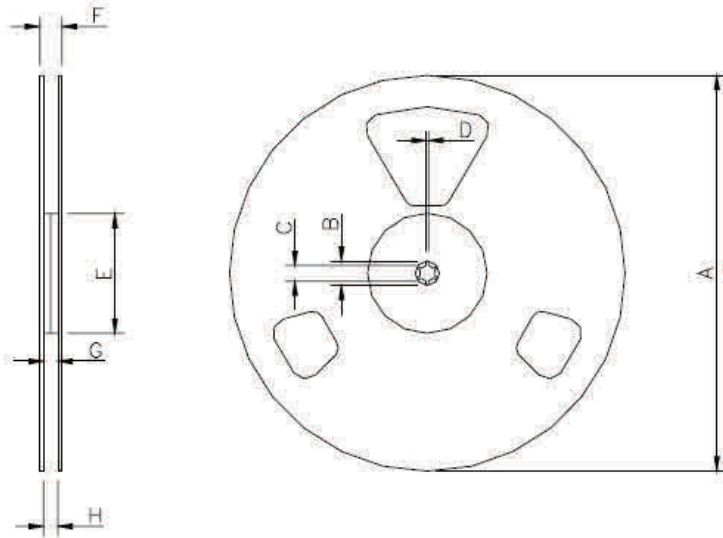

NOTE: Controlling dimensions in mm
 Std reel quantity is 4800 parts. (ordered as IRF6644TRPBF). For 1000 parts on 7" reel, order IRF6644TR1PBF.

REEL DIMENSIONS								
CODE	STANDARD OPTION (QTY 4800)				TR1 OPTION (QTY 1000)			
	METRIC		IMPERIAL		METRIC		IMPERIAL	
A	330.0	N.C	12.992	N.C	177.77	N.C	6.9	N.C
B	20.2	N.C	0.795	N.C	19.06	N.C	0.75	N.C
C	12.8	13.2	0.504	0.520	13.5	12.8	0.53	0.50
D	1.5	N.C	0.059	N.C	1.5	N.C	0.059	N.C
E	100.0	N.C	3.937	N.C	58.72	N.C	2.31	N.C
F	N.C	18.4	N.C	0.724	N.C	13.50	N.C	0.53
G	12.4	14.4	0.488	0.567	11.9	12.01	0.47	N.C
H	11.9	15.4	0.469	0.606	11.9	12.01	0.47	N.C

LOADED TAPE FEED DIRECTION

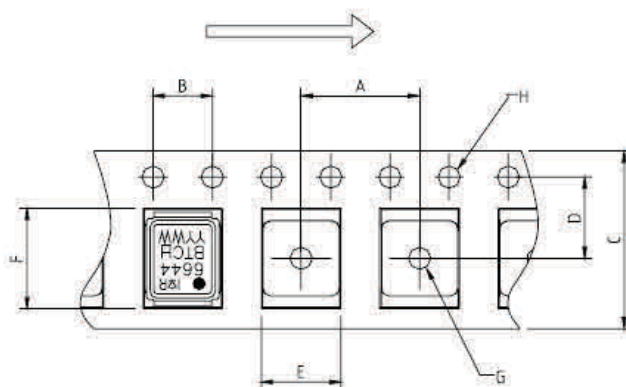

CODE	METRIC		IMPERIAL	
	MIN	MAX	MIN	MAX
A	7.90	8.10	0.311	0.319
B	3.90	4.10	0.154	0.161
C	11.90	12.30	0.469	0.484
D	5.45	5.55	0.215	0.219
E	5.10	5.30	0.201	0.209
F	6.50	6.70	0.256	0.264
G	1.50	N.C	0.059	N.C
H	1.50	1.60	0.059	0.063

Note: For the most current drawing please refer to website at : www.irf.com/package/

6 Qualification Information

Qualification Information

Qualification Level	Consumer (per JEDEC JESD47F) †	
Moisture Sensitivity Level	DirectFET™ Medium Can	MSL1 (per JEDEC J-STD-020D)†
RoHS Compliant	Yes	

† Applicable version of JEDEC standard at the time of product release.

Revision History

Major changes since the last revision

Page or Reference	Revision	Date	Description of changes
All pages	1.0	2006-08-18	<ul style="list-style-type: none">• First release data sheet.
All page	2.0	2017-03-28	<ul style="list-style-type: none">• This is Unique datasheet Project with Id Ratings based on RthJC.• The datasheet is converted in New Infineon Template.

Trademarks of Infineon Technologies AG

µHVIC™, µIPM™, µPFC™, AU-ConvertIR™, AURIX™, C166™, CanPAK™, CIPOST™, CIPURSE™, CoolDP™, CoolGaN™, COOLiR™, CoolMOS™, CoolSET™, CoolSiC™, DAVE™, DI-POL™, DirectFET™, DrBlade™, EasyPIM™, EconoBRIDGE™, EconoDUAL™, EconoPACK™, EconoPIM™, EiceDRIVER™, eupec™, FCOS™, GaNpowIR™, HEXFET™, HITFET™, HybridPACK™, iMOTION™, IRAM™, ISOFACE™, IsoPACK™, LEDrivIR™, LITIX™, MIPAQ™, ModSTACK™, my-d™, NovalithIC™, OPTIGA™, OptiMOS™, ORIGA™, PowIRaudio™, PowIRstage™, PrimePACK™, PrimeSTACK™, PROFET™, PRO-SIL™, RASIC™, REAL3™, SmartLEWIS™, SOLID FLASH™, SPOC™, StrongIRFET™, SupIRBuck™, TEMPFET™, TRENCHSTOP™, TriCore™, UHVIC™, XHP™, XMC™

Trademarks updated November 2015

Other Trademarks

All referenced product or service names and trademarks are the property of their respective owners.

IMPORTANT NOTICE

Edition 2015-05-06
Published by
Infineon Technologies AG
81726 Munich, Germany

© 2016 Infineon Technologies AG.
All Rights Reserved.

Do you have a question about this document?
Email: erratum@infineon.com

Document reference

The information given in this document shall in no event be regarded as a guarantee of conditions or characteristics ("Beschaffenheitsgarantie").

With respect to any examples, hints or any typical values stated herein and/or any information regarding the application of the product, Infineon Technologies hereby disclaims any and all warranties and liabilities of any kind, including without limitation warranties of non-infringement of intellectual property rights of any third party.

In addition, any information given in this document is subject to customer's compliance with its obligations stated in this document and any applicable legal requirements, norms and standards concerning customer's products and any use of the product of Infineon Technologies in customer's applications.

The data contained in this document is exclusively intended for technically trained staff. It is the responsibility of customer's technical departments to evaluate the suitability of the product for the intended application and the completeness of the product information given in this document with

For further information on the product, technology, delivery terms and conditions and prices please contact your nearest Infineon Technologies office (www.infineon.com).

WARNINGS

Due to technical requirements products may contain dangerous substances. For information on the types in question please contact your nearest Infineon Technologies office.

Except as otherwise explicitly approved by Infineon Technologies in a written document signed by authorized representatives of Infineon Technologies, Infineon Technologies' products may not be used in any applications where a failure of the product or any consequences of the use thereof can reasonably be expected to result in personal injury.

IMPORTANT NOTICE

The information given in this document shall in no event be regarded as a guarantee of conditions or characteristics ("Beschaffheitsgarantie").

With respect to any examples, hints or any typical values stated herein and/or any information regarding the application of the product, Infineon Technologies hereby disclaims any and all warranties and liabilities of any kind, including without limitation warranties of non-infringement of intellectual property rights of any third party.

In addition, any information given in this document is subject to customer's compliance with its obligations stated in this document and any applicable legal requirements, norms and standards concerning customer's products and any use of the product of Infineon Technologies in customer's applications.

The data contained in this document is exclusively intended for technically trained staff. It is the responsibility of customer's technical departments to evaluate the suitability of the product for the intended application and the completeness of the product information given in this document with respect to such application.

For further information on the product, technology, delivery terms and conditions and prices please contact your nearest Infineon Technologies office (www.infineon.com).

WARNINGS

Due to technical requirements products may contain dangerous substances. For information on the types in question please contact your nearest Infineon Technologies office.

Except as otherwise explicitly approved by Infineon Technologies in a written document signed by authorized representatives of Infineon Technologies, Infineon Technologies' products may not be used in any applications where a failure of the product or any consequences of the use thereof can reasonably be expected to result in personal injury.

Looking for pricing, stock, or lifecycle information?

Click below to explore more details on WIN SOURCE:

-  [View IRF6644TRPBF on WIN SOURCE](#)
-  [Infineon Technologies Information](#)

Optimize Your Supply Chain with WIN SOURCE Solutions

-  Global Sourcing Solution
-  Obsolete Management
-  Cost Control Management
-  Shortage Management
-  Alternative Solution
-  Excess Inventory Management