



**THE DATASHEET OF  
IRF7331TRPBF**



# IRF7331PbF

HEXFET® Power MOSFET

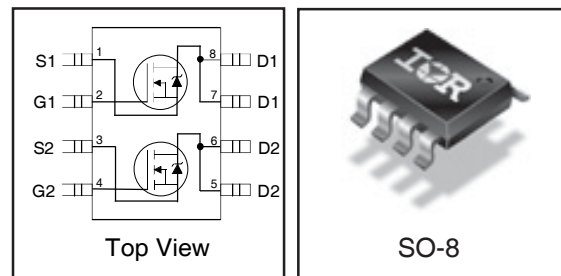
- Ultra Low On-Resistance
- Dual N-Channel MOSFET
- Surface Mount
- Available in Tape & Reel
- Lead-Free

V <sub>DSS</sub>	R <sub>DS(on)</sub> max (mΩ)	I <sub>D</sub>
20V	30 @ V <sub>GS</sub> = 4.5V	7.0A
	45 @ V <sub>GS</sub> = 2.5V	5.6A

## Description

These N-Channel HEXFET® power MOSFETs from International Rectifier utilize advanced processing techniques to achieve the extremely low on-resistance per silicon area. This benefit provides the designer with an extremely efficient device for use in battery and load management applications.

The SO-8 has been modified through a customized leadframe for enhanced thermal characteristics and multiple-die capability making it ideal in a variety of power applications. With these improvements, multiple devices can be used in an application with dramatically reduced board space. The package is designed for vapor phase, infrared, or wave soldering techniques.



## Absolute Maximum Ratings

	Parameter	Max.	Units
V <sub>DS</sub>	Drain- Source Voltage	20	V
I <sub>D</sub> @ T <sub>A</sub> = 25°C	Continuous Drain Current, V <sub>GS</sub> @ 4.5V	7.0	A
I <sub>D</sub> @ T <sub>A</sub> = 70°C	Continuous Drain Current, V <sub>GS</sub> @ 4.5V	5.5	
I <sub>DM</sub>	Pulsed Drain Current ①	28	
P <sub>D</sub> @ T <sub>A</sub> = 25°C	Power Dissipation ③	2.0	W
P <sub>D</sub> @ T <sub>A</sub> = 70°C	Power Dissipation ③	1.3	
	Linear Derating Factor	16	mW/°C
V <sub>GS</sub>	Gate-to-Source Voltage	± 12	V
T <sub>J</sub> , T <sub>STG</sub>	Junction and Storage Temperature Range	-55 to + 150	°C

## Thermal Resistance

Symbol	Parameter	Typ.	Max.	Units
R <sub>θJL</sub>	Junction-to-Drain Lead	—	42	°C/W
R <sub>θJA</sub>	Junction-to-Ambient ③	—	62.5	

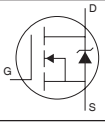
# IRF7331PbF

International  
IR Rectifier

## Electrical Characteristics @ $T_J = 25^\circ\text{C}$ (unless otherwise specified)

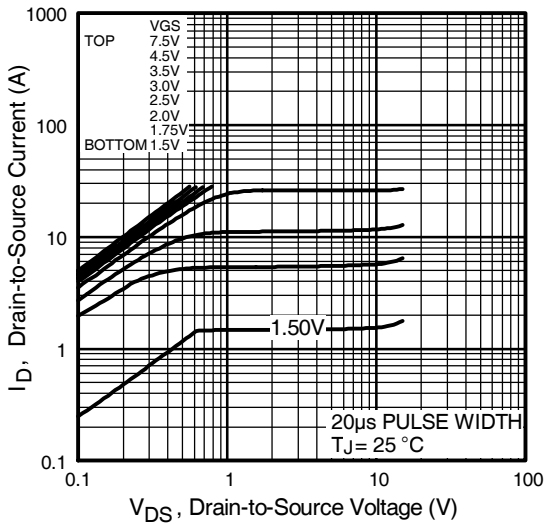
	Parameter	Min.	Typ.	Max.	Units	Conditions
$V_{(BR)DSS}$	Drain-to-Source Breakdown Voltage	20	—	—	V	$V_{GS} = 0V, I_D = 250\mu A$
$\Delta V_{(BR)DSS}/\Delta T_J$	Breakdown Voltage Temp. Coefficient	—	0.013	—	V/°C	Reference to $25^\circ\text{C}, I_D = 1\text{mA}$
$R_{DS(on)}$	Static Drain-to-Source On-Resistance	—	—	30	m $\Omega$	$V_{GS} = 4.5V, I_D = 7.0A$ ②
		—	—	45		$V_{GS} = 2.5V, I_D = 5.6A$ ②
$V_{GS(th)}$	Gate Threshold Voltage	0.6	—	1.2	V	$V_{DS} = V_{GS}, I_D = 250\mu A$
$g_{fs}$	Forward Transconductance	14	—	—	S	$V_{DS} = 10V, I_D = 7.0A$
$I_{DSS}$	Drain-to-Source Leakage Current	—	—	1.0	$\mu A$	$V_{DS} = 16V, V_{GS} = 0V$
		—	—	25		$V_{DS} = 16V, V_{GS} = 0V, T_J = 70^\circ\text{C}$
$I_{GSS}$	Gate-to-Source Forward Leakage	—	—	100	nA	$V_{GS} = 12V$
	Gate-to-Source Reverse Leakage	—	—	-100		$V_{GS} = -12V$
$Q_g$	Total Gate Charge	—	13	20	nC	$I_D = 7.0A$
$Q_{gs}$	Gate-to-Source Charge	—	3.7	—		$V_{DS} = 10V$
$Q_{gd}$	Gate-to-Drain ("Miller") Charge	—	2.1	—		$V_{GS} = 4.5V$
$t_{d(on)}$	Turn-On Delay Time	—	7.6	—	ns	$V_{DD} = 10V$ ②
$t_r$	Rise Time	—	22	—		$I_D = 1.0A$
$t_{d(off)}$	Turn-Off Delay Time	—	110	—		$R_G = 53\Omega$
$t_f$	Fall Time	—	50	—		$V_{GS} = 4.5V$
$C_{iss}$	Input Capacitance	—	1340	—	pF	$V_{GS} = 0V$
$C_{oss}$	Output Capacitance	—	170	—		$V_{DS} = 16V$
$C_{rss}$	Reverse Transfer Capacitance	—	120	—		$f = 1.0\text{MHz}$

## Source-Drain Ratings and Characteristics

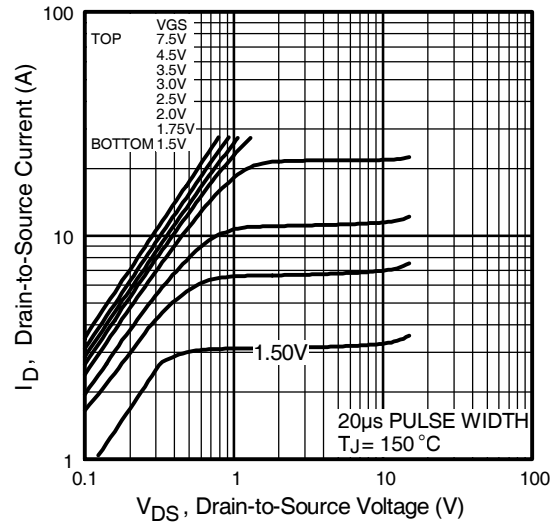
	Parameter	Min.	Typ.	Max.	Units	Conditions
$I_S$	Continuous Source Current (Body Diode)	—	—	2.0	A	MOSFET symbol showing the integral reverse p-n junction diode. 
$I_{SM}$	Pulsed Source Current (Body Diode) ①	—	—	28		
$V_{SD}$	Diode Forward Voltage	—	—	1.2	V	$T_J = 25^\circ\text{C}, I_S = 2.0A, V_{GS} = 0V$ ②
$t_{rr}$	Reverse Recovery Time	—	31	47	ns	$T_J = 25^\circ\text{C}, I_F = 2.0A$
$Q_{rr}$	Reverse Recovery Charge	—	15	23	nC	$di/dt = 100A/\mu s$ ②

### Notes:

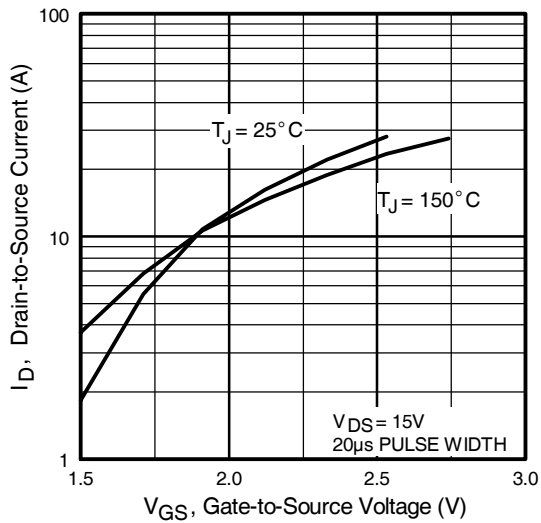
- ① Repetitive rating; pulse width limited by max. junction temperature.
- ② Pulse width  $\leq 400\mu s$ ; duty cycle  $\leq 2\%$ .
- ③ Surface mounted on 1 in square Cu board



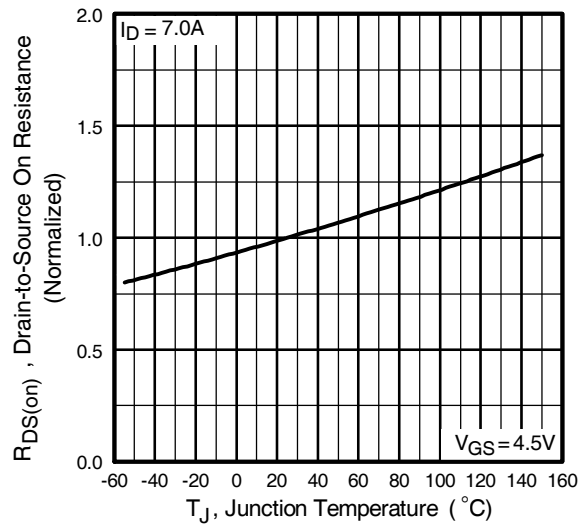
**Fig 1.** Typical Output Characteristics



**Fig 2.** Typical Output Characteristics

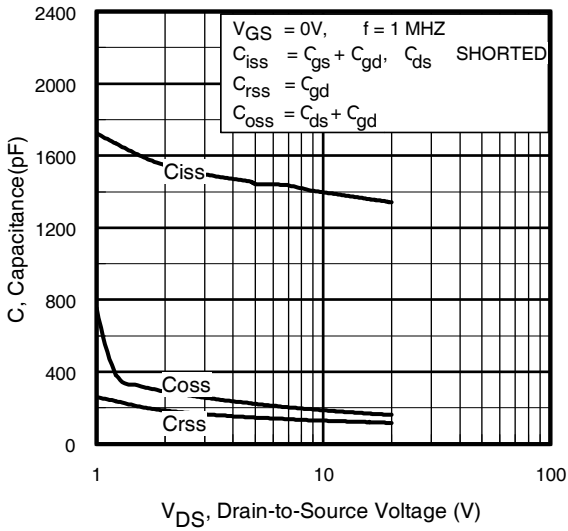


**Fig 3.** Typical Transfer Characteristics

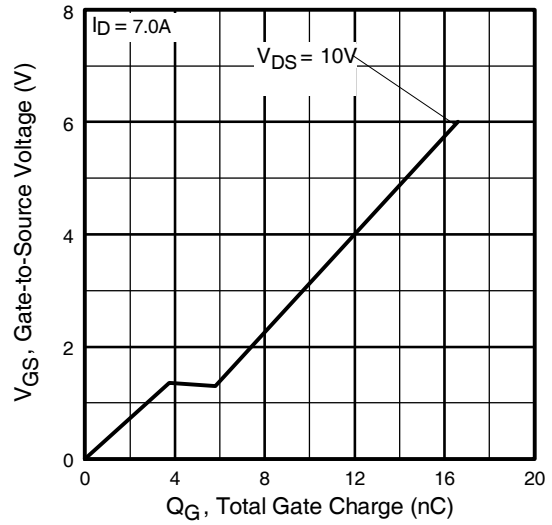


**Fig 4.** Normalized On-Resistance Vs. Temperature

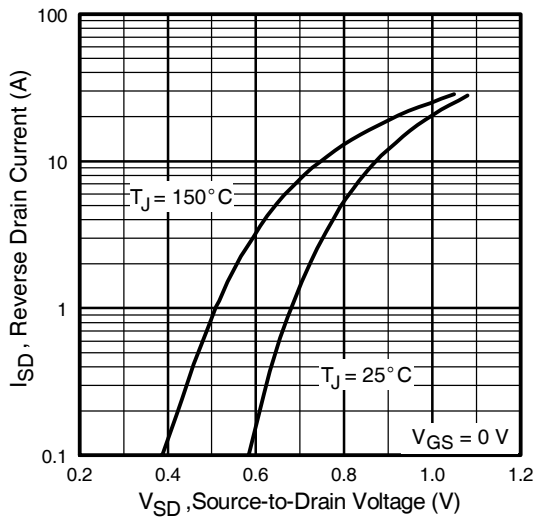
# IRF7331PbF



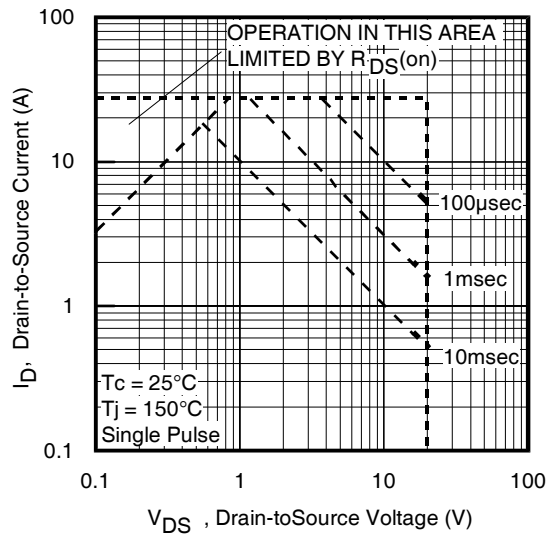
**Fig 5.** Typical Capacitance Vs. Drain-to-Source Voltage



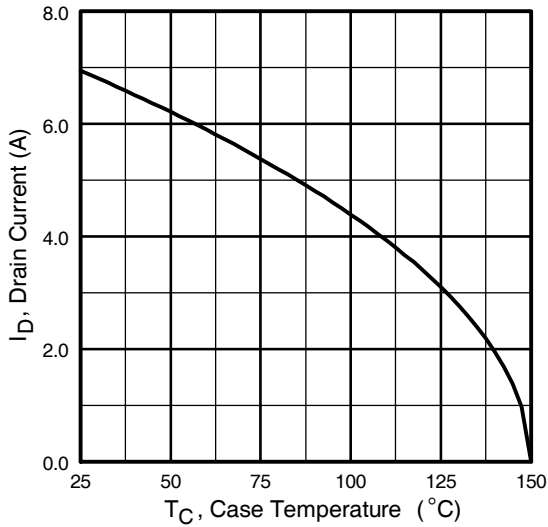
**Fig 6.** Typical Gate Charge Vs. Gate-to-Source Voltage



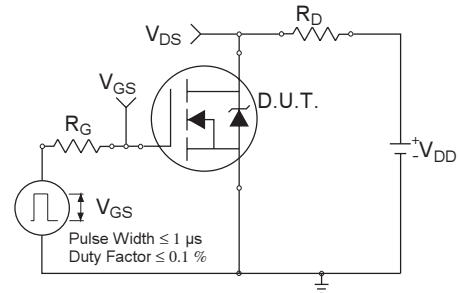
**Fig 7.** Typical Source-Drain Diode Forward Voltage



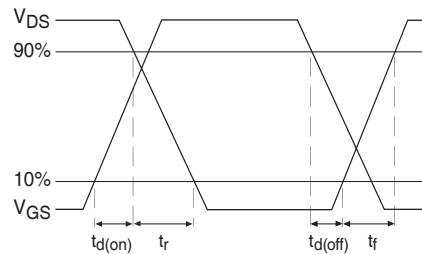
**Fig 8.** Maximum Safe Operating Area



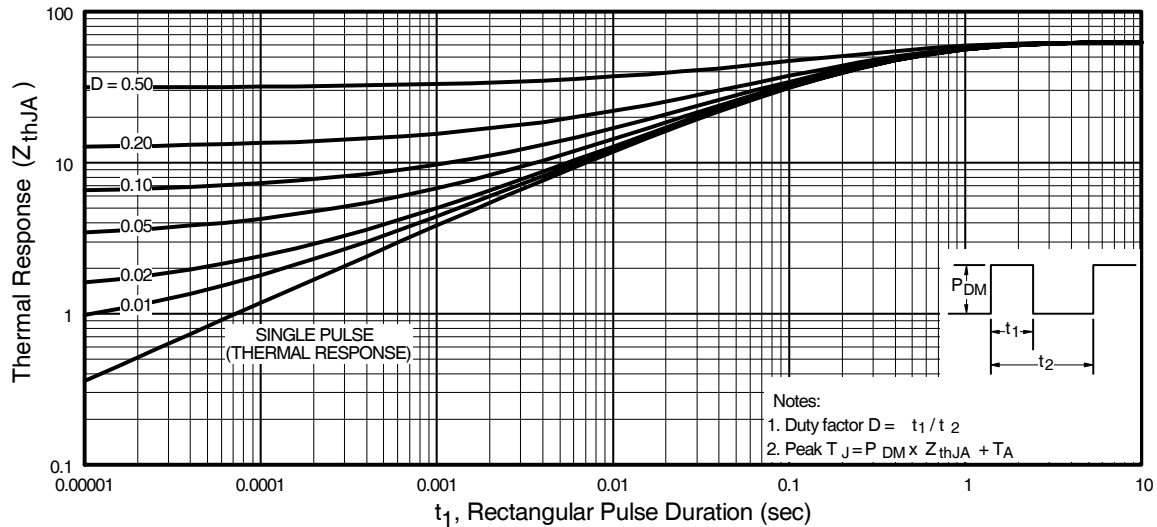
**Fig 9.** Maximum Drain Current Vs. Case Temperature



**Fig 10a.** Switching Time Test Circuit



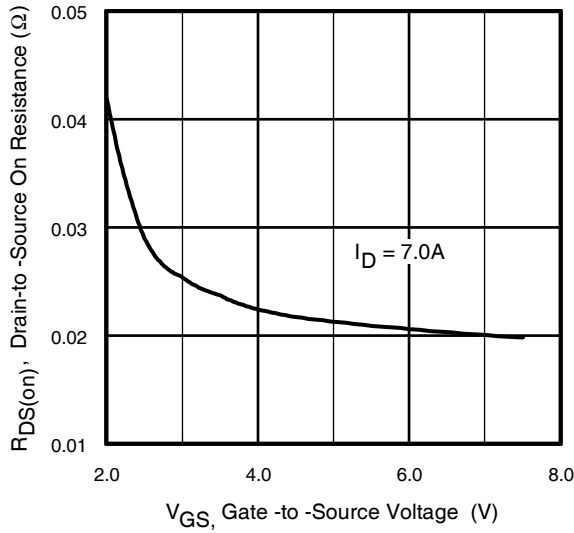
**Fig 10b.** Switching Time Waveforms



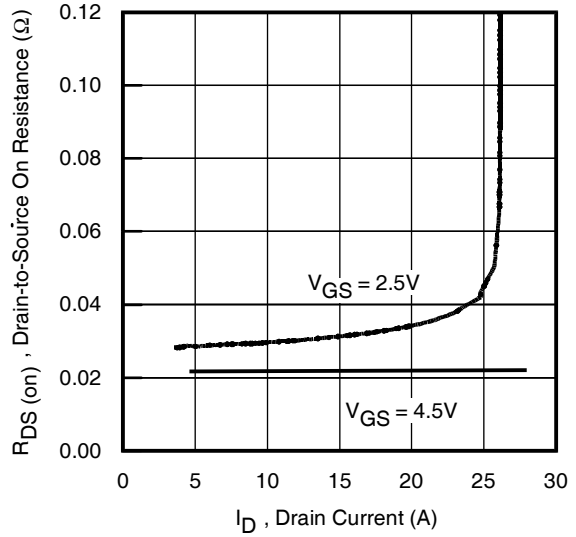
**Fig 11.** Maximum Effective Transient Thermal Impedance, Junction-to-Ambient

# IRF7331PbF

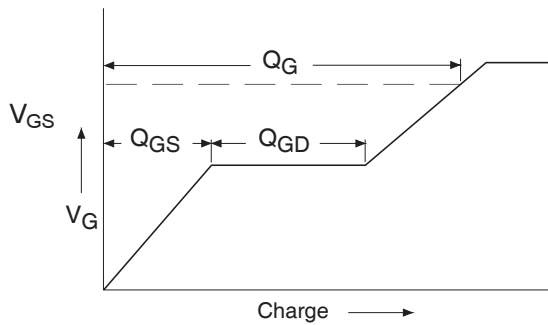
International  
**IR** Rectifier



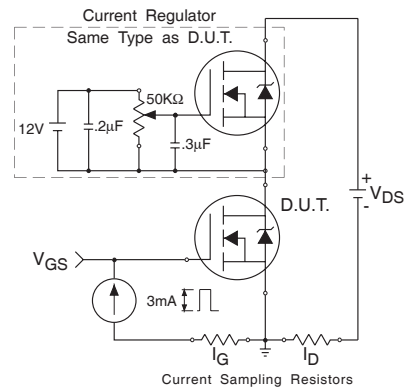
**Fig 12.** Typical On-Resistance Vs. Gate Voltage



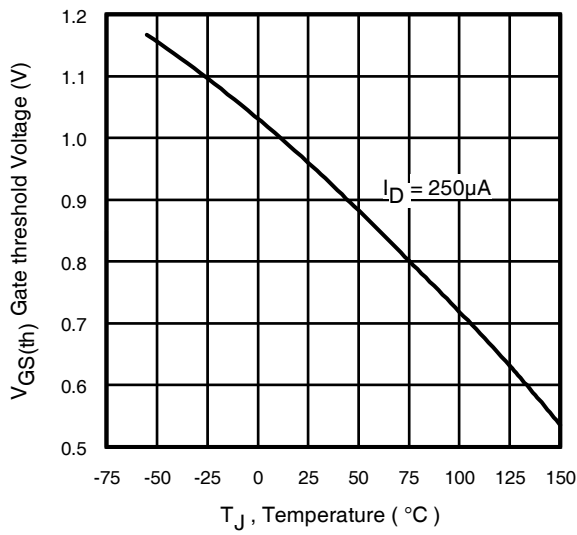
**Fig 13.** Typical On-Resistance Vs. Drain Current



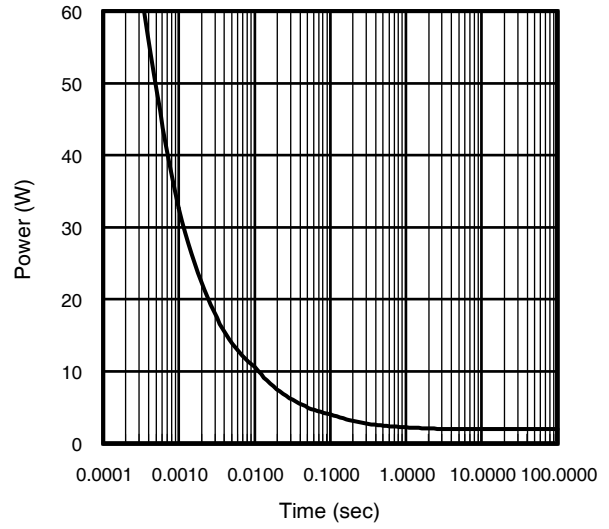
**Fig 14a.** Basic Gate Charge Waveform



**Fig 14b.** Gate Charge Test Circuit



**Fig 15.** Typical  $V_{GS(th)}$  Vs. Junction Temperature

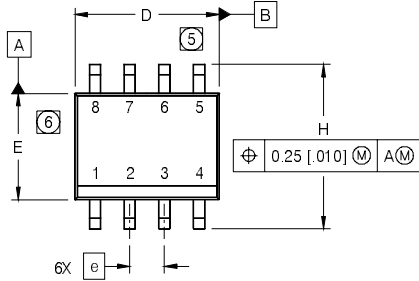


**Fig 16.** Typical Power Vs. Time

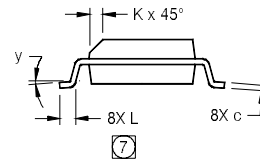
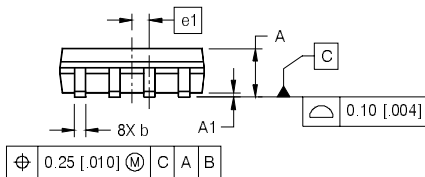
# IRF7331PbF

## SO-8 Package Outline (MOSFET & Fetky)

Dimensions are shown in millimeters (inches)



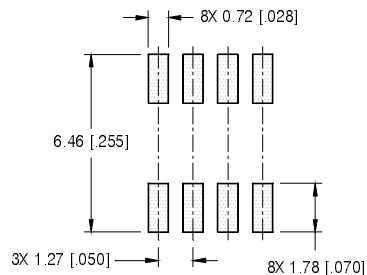
DIM	INCHES		MILLIMETERS	
	MIN	MAX	MIN	MAX
A	.0532	.0688	1.35	1.75
A1	.0040	.0098	0.10	0.25
b	.013	.020	0.33	0.51
c	.0075	.0098	0.19	0.25
D	.189	.1968	4.80	5.00
E	.1497	.1574	3.80	4.00
e	.050 BASIC		1.27 BASIC	
e1	.025 BASIC		0.635 BASIC	
H	.2284	.2440	5.80	6.20
K	.0099	.0196	0.25	0.50
L	.016	.050	0.40	1.27
y	0°	8°	0°	8°



### NOTES:

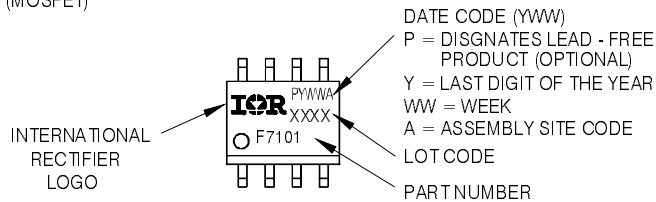
1. DIMENSIONING & TOLERANCING PER ASME Y14.5M-1994.
2. CONTROLLING DIMENSION: MILLIMETER
3. DIMENSIONS ARE SHOWN IN MILLIMETERS [INCHES].
4. OUTLINE CONFORMS TO JEDEC OUTLINE MS-012AA.
5. DIMENSION DOES NOT INCLUDE MOLD PROTRUSIONS. MOLD PROTRUSIONS NOT TO EXCEED 0.15 [0.006].
6. DIMENSION DOES NOT INCLUDE MOLD PROTRUSIONS. MOLD PROTRUSIONS NOT TO EXCEED 0.25 [0.010].
7. DIMENSION IS THE LENGTH OF LEAD FOR SOLDERING TO A SUBSTRATE.

### FOOTPRINT



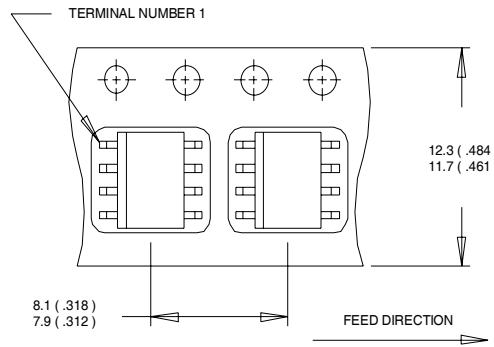
## SO-8 Part Marking Information

EXAMPLE: THIS IS AN IRF7101 (MOSFET)

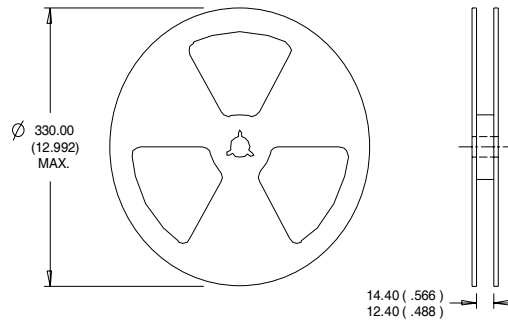


Note: For the most current drawing please refer to IR website at: <http://www.irf.com/package/>

## SO-8 Tape and Reel



- NOTES:
1. CONTROLLING DIMENSION : MILLIMETER.
  2. ALL DIMENSIONS ARE SHOWN IN MILLIMETERS(INCHES).
  3. OUTLINE CONFORMS TO EIA-481 & EIA-541.



- NOTES :
1. CONTROLLING DIMENSION : MILLIMETER.
  2. OUTLINE CONFORMS TO EIA-481 & EIA-541.

**Note:** For the most current drawing please refer to IR website at: <http://www.irf.com/package/>

Data and specifications subject to change without notice.  
 This product has been designed and qualified for the Consumer market.  
 Qualification Standards can be found on IR's Web site.

## **IMPORTANT NOTICE**

The information given in this document shall in no event be regarded as a guarantee of conditions or characteristics ("Beschaffheitsgarantie").

With respect to any examples, hints or any typical values stated herein and/or any information regarding the application of the product, Infineon Technologies hereby disclaims any and all warranties and liabilities of any kind, including without limitation warranties of non-infringement of intellectual property rights of any third party.

In addition, any information given in this document is subject to customer's compliance with its obligations stated in this document and any applicable legal requirements, norms and standards concerning customer's products and any use of the product of Infineon Technologies in customer's applications.

The data contained in this document is exclusively intended for technically trained staff. It is the responsibility of customer's technical departments to evaluate the suitability of the product for the intended application and the completeness of the product information given in this document with respect to such application.

For further information on the product, technology, delivery terms and conditions and prices please contact your nearest Infineon Technologies office ([www.infineon.com](http://www.infineon.com)).

## **WARNINGS**

Due to technical requirements products may contain dangerous substances. For information on the types in question please contact your nearest Infineon Technologies office.

Except as otherwise explicitly approved by Infineon Technologies in a written document signed by authorized representatives of Infineon Technologies, Infineon Technologies' products may not be used in any applications where a failure of the product or any consequences of the use thereof can reasonably be expected to result in personal injury.

## Looking for pricing, stock, or lifecycle information?

Click below to explore more details on WIN SOURCE:

 [View IRF7331TRPBF on WIN SOURCE](#)

 [Infineon Technologies](#) Information

## Optimize Your Supply Chain with WIN SOURCE Solutions

-  Global Sourcing Solution
-  Obsolete Management
-  Cost Control Management
-  Shortage Management
-  Alternative Solution
-  Excess Inventory Management