



**THE DATASHEET OF
IRF7353D1TRPBF**



IRF7353D1PbF

FETKY™ MOSFET / Schottky Diode

- Co-packaged HEXFET® Power MOSFET and Schottky Diode
- Ideal For Buck Regulator Applications
- N-Channel HEXFET
- Low V_F Schottky Rectifier
- Generation 5 Technology
- SO-8 Footprint
- Lead-Free

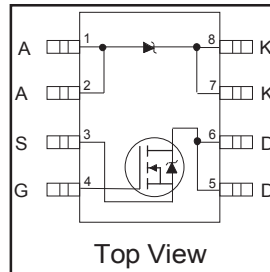

| |
|----------------------------|
| $V_{DSS} = 30V$ |
| $R_{DS(on)} = 0.029\Omega$ |
| Schottky $V_f = 0.39V$ |

Description

The **FETKY** family of co-packaged MOSFETs and Schottky diodes offers the designer an innovative, board space saving solution for switching regulator and power management applications. Generation 5 HEXFET Power MOSFETs utilize advanced processing techniques to achieve extremely low on-resistance per silicon area. Combining this technology with International Rectifier's low forward drop Schottky rectifiers results in an extremely efficient device suitable for use in a wide variety of portable electronics applications.

The SO-8 has been modified through a customized leadframe for enhanced thermal characteristics. The SO-8 package is designed for vapor phase, infrared or wave soldering techniques.

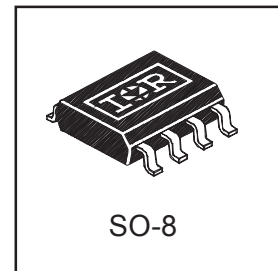

Absolute Maximum Ratings ($T_A = 25^\circ C$ unless otherwise noted)

| Parameter | | Maximum | Units |
|--------------------------|--|-------------|-------|
| $I_D @ T_A = 25^\circ C$ | Continuous Drain Current | 6.5 | A |
| $I_D @ T_A = 70^\circ C$ | | 5.2 | |
| I_{DM} | Pulsed Drain Current ① | 52 | |
| $P_D @ T_A = 25^\circ C$ | Power Dissipation | 2.0 | W |
| $P_D @ T_A = 70^\circ C$ | | 1.3 | |
| | Linear Derating Factor | 16 | mW/°C |
| V_{GS} | Gate-to-Source Voltage | ± 20 | V |
| dv/dt | Peak Diode Recovery dv/dt ② | -5.0 | V/ns |
| T_J, T_{STG} | Junction and Storage Temperature Range | -55 to +150 | °C |

Thermal Resistance Ratings

| Parameter | | Maximum | Units |
|-----------------|-----------------------|---------|-------|
| $R_{\theta JA}$ | Junction-to-Ambient ③ | 62.5 | °C/W |

Notes:

- ① Repetitive rating; pulse width limited by maximum junction temperature (see figure 9)
- ② Starting $T_J = 25^\circ C$, $L = 10mH$, $R_G = 25\Omega$, $I_{AS} = 4.0A$
- ③ $I_{SD} \leq 4.0A$, $di/dt \leq 74A/\mu s$, $V_{DD} \leq V_{(BR)DSS}$, $T_J \leq 150^\circ C$
- ④ Surface mounted on FR-4 board, $t \leq 10sec$.

MOSFET Electrical Characteristics @ T_J = 25°C (unless otherwise specified)

| Parameter | | Min. | Typ. | Max. | Units | Conditions |
|----------------------|--------------------------------------|------|-------|-------|-------|--|
| V _{(BR)DSS} | Drain-to-Source Breakdown Voltage | 30 | — | — | V | V _{GS} = 0V, I _D = 250μA |
| R _{DS(on)} | Static Drain-to-Source On-Resistance | — | 0.023 | 0.032 | Ω | V _{GS} = 10V, I _D = 5.8A |
| | | — | 0.032 | 0.046 | | V _{GS} = 4.5V, I _D = 4.7A |
| V _{GS(th)} | Gate Threshold Voltage | 1.0 | — | — | V | V _{DS} = V _{GS} , I _D = 250μA |
| g _{fs} | Forward Transconductance | — | 14 | — | S | V _{DS} = 24V, I _D = 5.8A |
| I _{DSS} | Drain-to-Source Leakage Current | — | — | 1.0 | μA | V _{DS} = 24V, V _{GS} = 0V |
| | | — | — | 25 | | V _{DS} = 24V, V _{GS} = 0V, T _J = 55°C |
| I _{GSS} | Gate-to-Source Forward Leakage | — | — | 100 | nA | V _{GS} = 20V |
| | Gate-to-Source Reverse Leakage | — | — | -100 | | V _{GS} = -20V |
| Q _g | Total Gate Charge | — | 22 | 33 | nC | I _D = 5.8A |
| Q _{gs} | Gate-to-Source Charge | — | 2.6 | 3.9 | | V _{DS} = 24V |
| Q _{gd} | Gate-to-Drain ("Miller") Charge | — | 6.4 | 9.6 | | V _{GS} = 10V (see figure 8) |
| t _{d(on)} | Turn-On Delay Time | — | 8.1 | 12 | ns | V _{DD} = 15V |
| t _r | Rise Time | — | 8.9 | 13 | | I _D = 1.0A |
| t _{d(off)} | Turn-Off Delay Time | — | 26 | 39 | | R _G = 6.0Ω |
| t _f | Fall Time | — | 17 | 26 | | R _D = 15Ω |
| C _{iss} | Input Capacitance | — | 650 | — | pF | V _{GS} = 0V |
| C _{oss} | Output Capacitance | — | 320 | — | | V _{DS} = 25V |
| C _{rss} | Reverse Transfer Capacitance | — | 130 | — | | f = 1.0MHz (see figure 7) |

MOSFET Source-Drain Ratings and Characteristics

| Parameter | | Min. | Typ. | Max. | Units | Conditions |
|-----------------|--|------|------|------|-------|--|
| I _S | Continuous Source Current (Body Diode) | — | — | 2.5 | A | |
| I _{SM} | Pulsed Source Current (Body Diode) | — | — | 30 | | |
| V _{SD} | Body Diode Forward Voltage | — | 0.78 | 1.0 | V | T _J = 25°C, I _S = 1.7A, V _{GS} = 0V |
| t _{rr} | Reverse Recovery Time (Body Diode) | — | 45 | 68 | ns | T _J = 25°C, I _F = 1.7A |
| Q _{rr} | Reverse Recovery Charge | — | 58 | 87 | nC | di/dt = 100A/μs Ⓢ |

Schottky Diode Maximum Ratings

| | Parameter | Max. | Units | Conditions |
|--------------------|--|------|-------|--|
| I _{F(av)} | Max. Average Forward Current | 2.7 | A | 50% Duty Cycle. Rectangular Wave, T _A = 25°C |
| | | 1.9 | | See Fig. 14 T _A = 70°C |
| I _{SM} | Max. peak one cycle Non-repetitive Surge current | 120 | A | 5μs sine or 3μs Rect. pulse |
| | | 11 | | 10ms sine or 6ms Rect. pulse |
| | | | | Following any rated load condition & with V _{RRM} applied |

Schottky Diode Electrical Specifications

| | Parameter | Max. | Units | Conditions |
|-----------------|------------------------------|------|-------|---|
| V _{FM} | Max. Forward voltage drop | 0.50 | V | I _F = 1.0A, T _J = 25°C |
| | | 0.62 | | I _F = 2.0A, T _J = 25°C |
| | | 0.39 | | I _F = 1.0A, T _J = 125°C |
| | | 0.57 | | I _F = 2.0A, T _J = 125°C . |
| I _{RM} | Max. Reverse Leakage current | 0.06 | mA | V _R = 30V T _J = 25°C |
| | | 16 | | T _J = 125°C |
| C _t | Max. Junction Capacitance | 92 | pF | V _R = 5Vdc (100kHz to 1 MHz) 25°C |
| dv/dt | Max. Voltage Rate of Charge | 3600 | V/ μs | Rated V _R |

Power Mosfet Characteristics

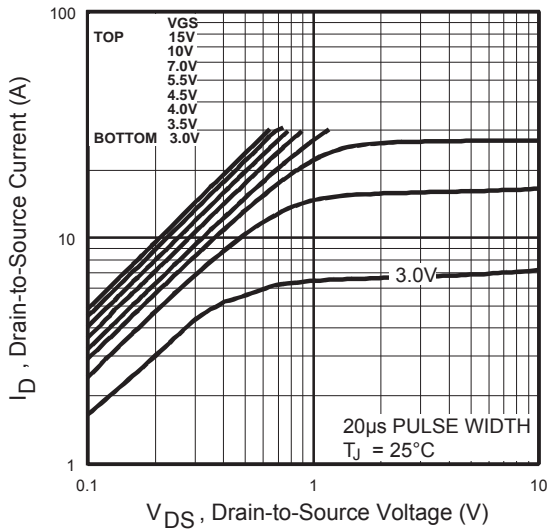

Fig 1. Typical Output Characteristics

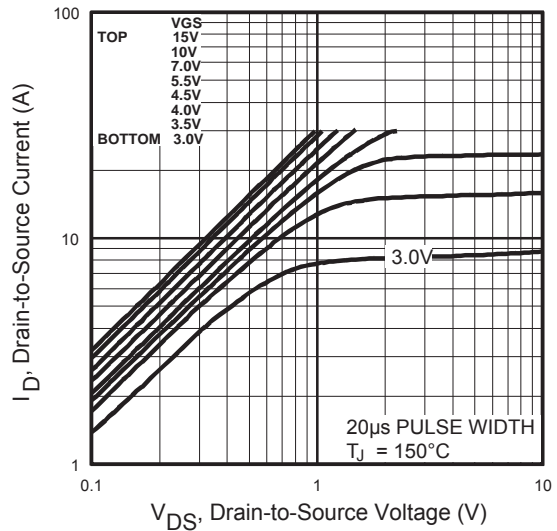

Fig 2. Typical Output Characteristics

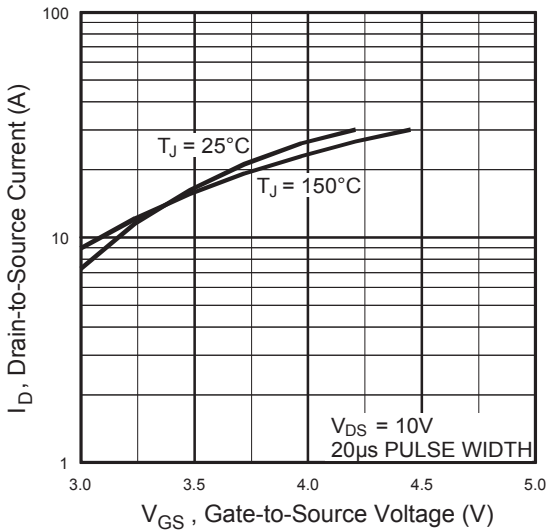

Fig 3. Typical Transfer Characteristics

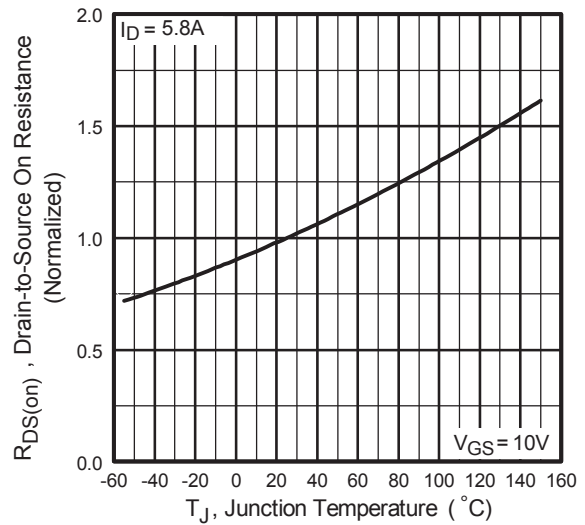

Fig 4. Normalized On-Resistance Vs. Temperature

Power Mosfet Characteristics

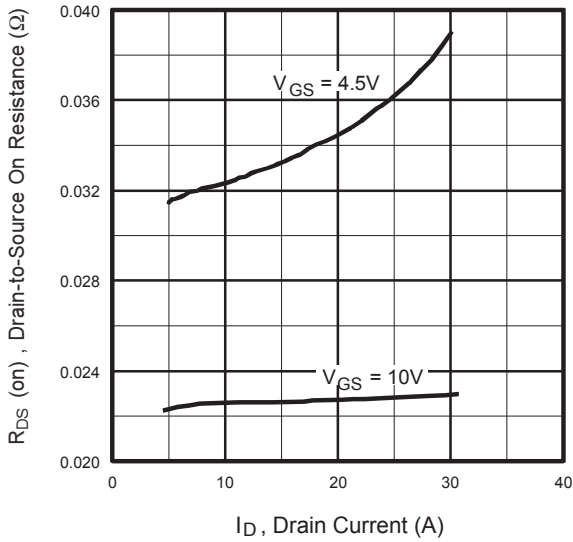

Fig 5. Typical On-Resistance Vs. Drain Current

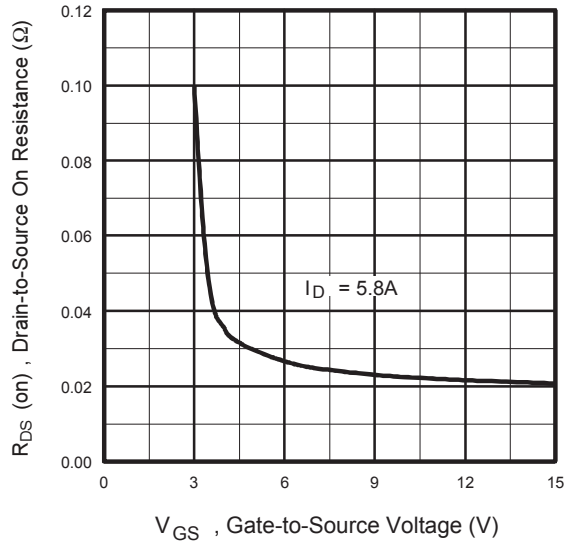

Fig 6. Typical On-Resistance Vs. Gate Voltage

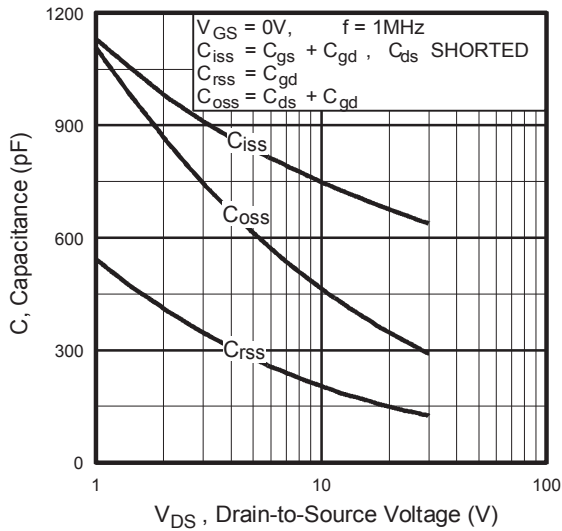

Fig 7. Typical Capacitance Vs. Drain-to-Source Voltage

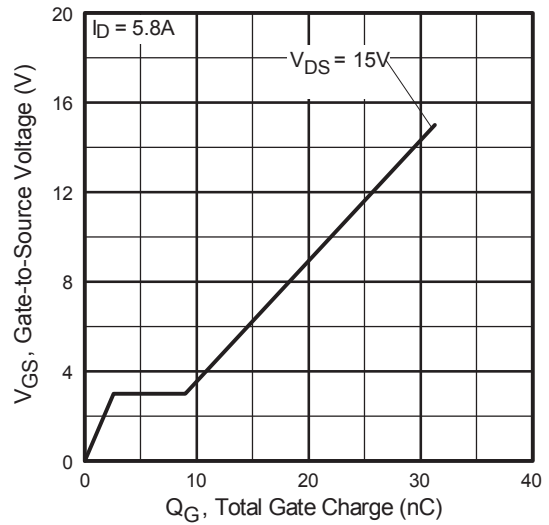

Fig 8. Typical Gate Charge Vs. Gate-to-Source Voltage

Power Mosfet Characteristics

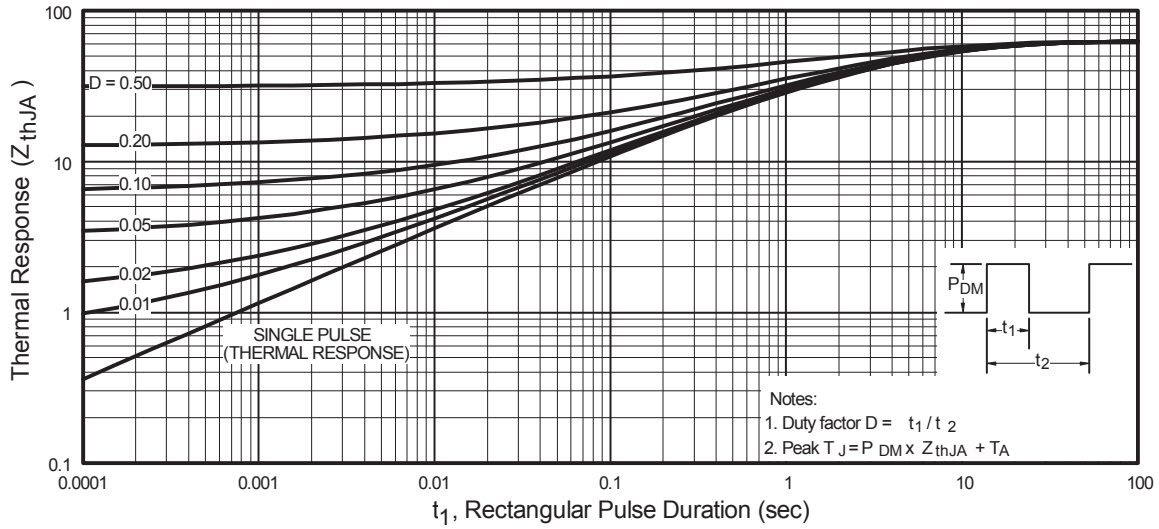

Fig 9. Maximum Effective Transient Thermal Impedance, Junction-to-Ambient

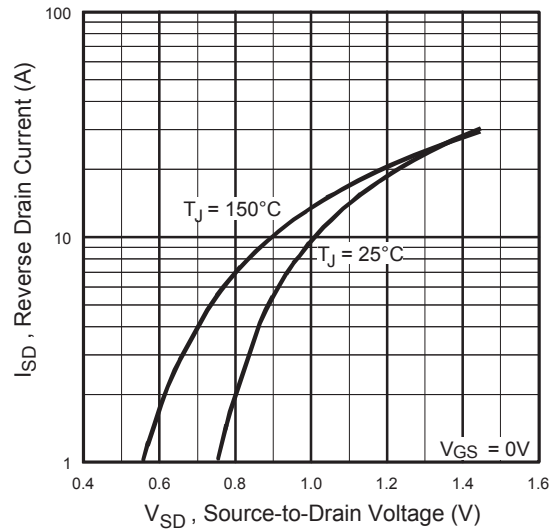

Fig 10. Typical Source-Drain Diode Forward Voltage

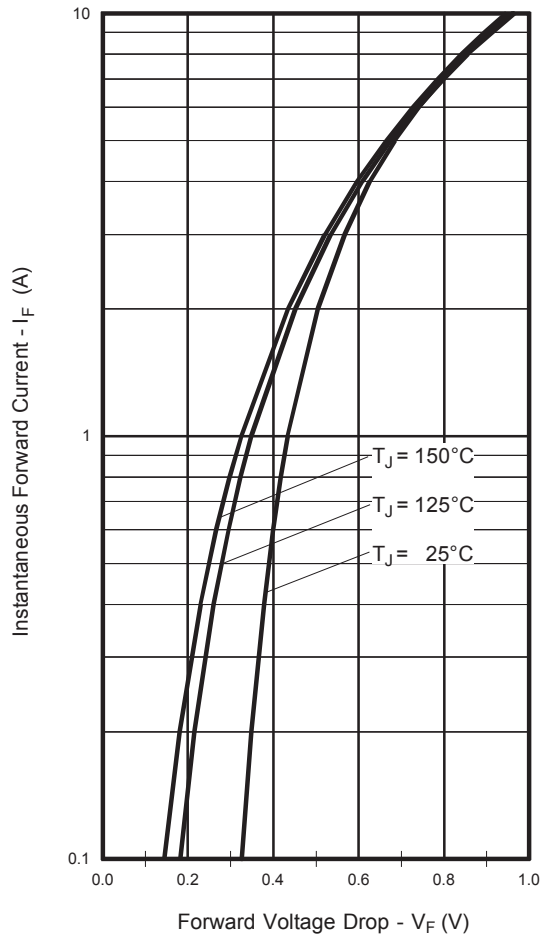

Fig. 12 - Typical Forward Voltage Drop Characteristics

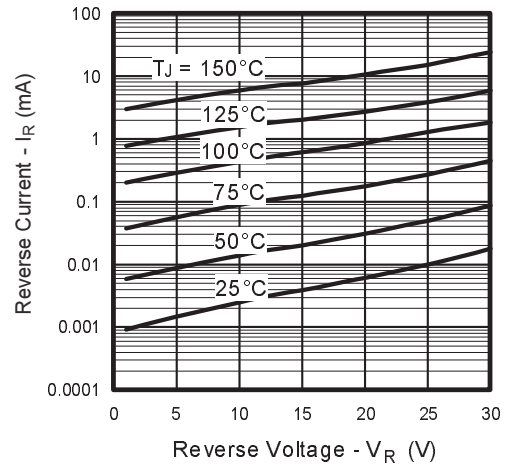

Fig. 13 - Typical Values of Reverse Current Vs. Reverse Voltage

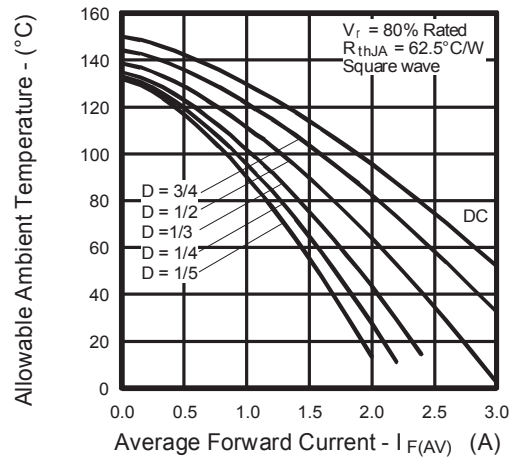
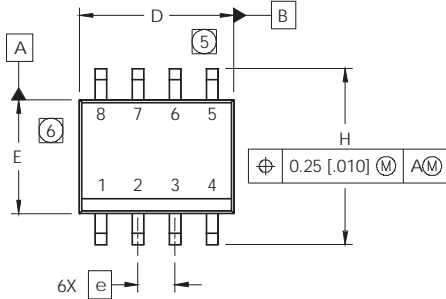
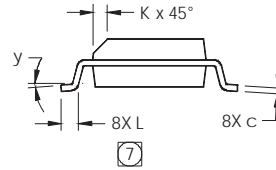
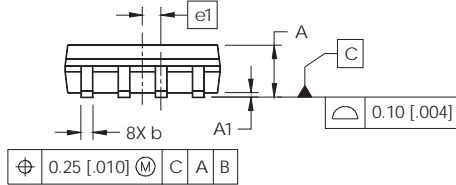

Fig.14 - Maximum Allowable Ambient Temp. Vs. Forward Current

SO-8 (Fetky) Package Outline (Dimensions are shown in millimeters (inches))



| DIM | INCHES | | MILLIMETERS | |
|-----|------------|-------|-------------|------|
| | MIN | MAX | MIN | MAX |
| A | .0532 | .0688 | 1.35 | 1.75 |
| A1 | .0040 | .0098 | 0.10 | 0.25 |
| b | .013 | .020 | 0.33 | 0.51 |
| c | .0075 | .0098 | 0.19 | 0.25 |
| D | .189 | .1968 | 4.80 | 5.00 |
| E | .1497 | .1574 | 3.80 | 4.00 |
| e | .050 BASIC | | 1.27 BASIC | |
| e1 | .025 BASIC | | 0.635 BASIC | |
| H | .2284 | .2440 | 5.80 | 6.20 |
| K | .0099 | .0196 | 0.25 | 0.50 |
| L | .016 | .050 | 0.40 | 1.27 |
| y | 0° | 8° | 0° | 8° |



NOTES:

1. DIMENSIONING & TOLERANCING PER ASME Y14.5M-1994.
2. CONTROLLING DIMENSION: MILLIMETER
3. DIMENSIONS ARE SHOWN IN MILLIMETERS [INCHES].
4. OUTLINE CONFORMS TO JEDEC OUTLINE MS-012AA
- ⑤ DIMENSION DOES NOT INCLUDE MOLD PROTRUSIONS. MOLD PROTRUSIONS NOT TO EXCEED 0.15 [0.006].
- ⑥ DIMENSION DOES NOT INCLUDE MOLD PROTRUSIONS. MOLD PROTRUSIONS NOT TO EXCEED 0.25 [0.010].
- ⑦ DIMENSION IS THE LENGTH OF LEAD FOR SOLDERING TO A SUBSTRATE.

FOOT PRINT

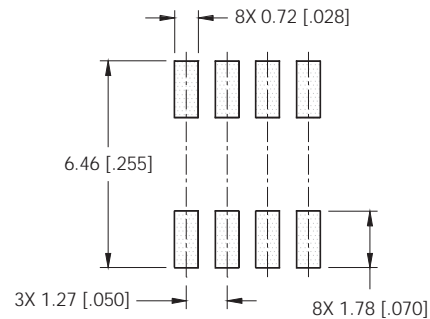

SO-8 (Fetky) Part Marking Information

EXAMPLE: THIS IS AN IRF7807D1 (FETKY)

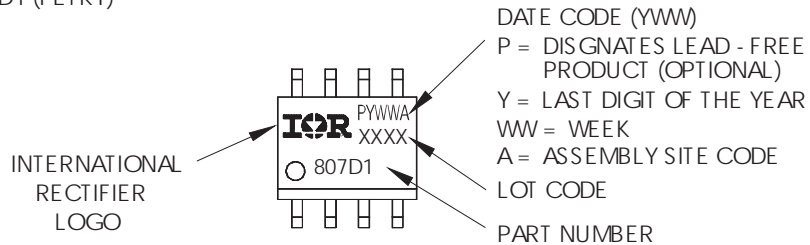

IRF7353D1PbF

International
IR Rectifier

SO-8 (Fetky) Tape and Reel

Dimensions are shown in millimeters (inches)

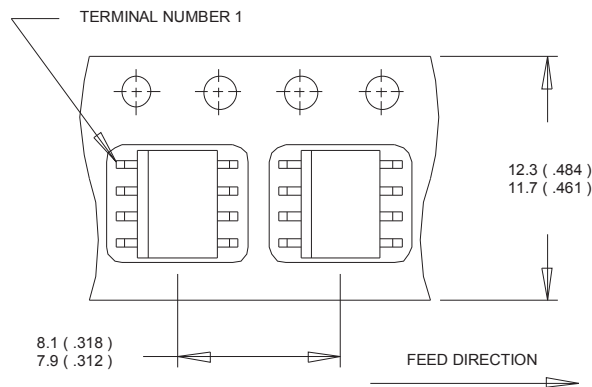

NOTES:

1. CONTROLLING DIMENSION : MILLIMETER.
2. ALL DIMENSIONS ARE SHOWN IN MILLIMETERS(INCHES).
3. OUTLINE CONFORMS TO EIA-481 & EIA-541.

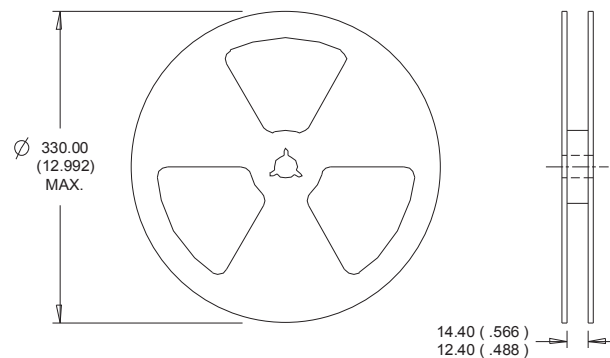

NOTES :

1. CONTROLLING DIMENSION : MILLIMETER.
2. OUTLINE CONFORMS TO EIA-481 & EIA-541.

Data and specifications subject to change without notice.
This product has been designed and qualified for the Consumer market.
Qualification Standards can be found on IR's Web site.

International
IR Rectifier

IR WORLD HEADQUARTERS: 233 Kansas St., El Segundo, California 90245, USA Tel: (310) 252-7105
TAC Fax: (310) 252-7903

Visit us at www.irf.com for sales contact information.10/04

www.irf.com

Looking for pricing, stock, or lifecycle information?

Click below to explore more details on WIN SOURCE:

 [View IRF7353D1TRPBF on WIN SOURCE](#)

 [Infineon Technologies](#) Information

Optimize Your Supply Chain with WIN SOURCE Solutions

-  Global Sourcing Solution
-  Obsolete Management
-  Cost Control Management
-  Shortage Management
-  Alternative Solution
-  Excess Inventory Management