



**THE DATASHEET OF  
IRF740ASTRLPBF**

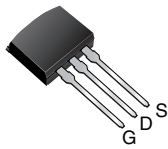




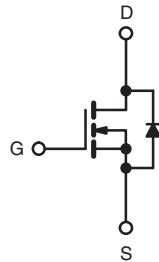
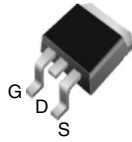
## Power MOSFET

PRODUCT SUMMARY	
$V_{DS}$ (V)	400
$R_{DS(on)}$ ( $\Omega$ )	$V_{GS} = 10\text{ V}$ 0.55
$Q_g$ (Max.) (nC)	36
$Q_{gs}$ (nC)	9.9
$Q_{gd}$ (nC)	16
Configuration	Single

I<sup>2</sup>PAK (TO-262)



D<sup>2</sup>PAK (TO-263)



N-Channel MOSFET

### FEATURES

- Halogen-free According to IEC 61249-2-21 Definition
- Low Gate Charge  $Q_g$  Results in Simple Drive Requirement
- Improved Gate, Avalanche and Dynamic  $dV/dt$  Ruggedness
- Fully Characterized Capacitance and Avalanche Voltage and Current
- Effective  $C_{oss}$  specified
- Compliant to RoHS Directive 2002/95/EC



**RoHS\***  
COMPLIANT  
HALOGEN  
**FREE**  
Available

### APPLICATIONS

- Switch Mode Power Supply (SMPS)
- Uninterruptible Power Supply
- High speed Power Switching

### TYPICAL SMPS TOPOLOGIES

- Single Transistor Flyback Xfmr. Reset
- Single Transistor Forward Xfmr. Reset (Both for US Line Input Only)

ORDERING INFORMATION				
Package	D <sup>2</sup> PAK (TO-263)	D <sup>2</sup> PAK (TO-263)	D <sup>2</sup> PAK (TO-263)	I <sup>2</sup> PAK (TO-262)
Lead (Pb)-free and Halogen-free	SiHF740AS-GE3	SiHF740ASTRL-GE3 <sup>a</sup>	SiHF740ASTRR-GE3 <sup>a</sup>	SiHF740AL-GE3
Lead (Pb)-free	IRF740ASPbF	IRF740ASTRLPbF <sup>a</sup>	IRF740ASTRRPbF <sup>a</sup>	IRF740ALPbF
	SiHF740AS-E3	SiHF740ASTL-E3 <sup>a</sup>	SiHF740ASTR-E3 <sup>a</sup>	SiHF740AL-E3

#### Note

a. See device orientation.

ABSOLUTE MAXIMUM RATINGS ( $T_C = 25\text{ }^\circ\text{C}$ , unless otherwise noted)			
PARAMETER	SYMBOL	LIMIT	UNIT
Drain-Source Voltage	$V_{DS}$	400	V
Gate-Source Voltage	$V_{GS}$	$\pm 30$	
Continuous Drain Current <sup>e</sup>	$V_{GS}$ at 10 V	$T_C = 25\text{ }^\circ\text{C}$	10
		$T_C = 100\text{ }^\circ\text{C}$	6.3
Pulsed Drain Current <sup>a, e</sup>		$I_{DM}$	40
Linear Derating Factor			1.0
Single Pulse Avalanche Energy <sup>b, e</sup>		$E_{AS}$	630
Avalanche Current <sup>a</sup>		$I_{AR}$	10
Repetitive Avalanche Energy <sup>a</sup>		$E_{AR}$	12.5
Maximum Power Dissipation		$T_A = 25\text{ }^\circ\text{C}$	3.1
		$T_C = 25\text{ }^\circ\text{C}$	125
Peak Diode Recovery $dV/dt$ <sup>c, e</sup>		$dV/dt$	5.9
Operating Junction and Storage Temperature Range		$T_J, T_{stg}$	- 55 to + 150
Soldering Recommendations (Peak Temperature)		for 10 s	300 <sup>d</sup>

#### Notes


- Repetitive rating; pulse width limited by maximum junction temperature (see fig. 11).
- Starting  $T_J = 25\text{ }^\circ\text{C}$ ,  $L = 12.6\text{ mH}$ ,  $R_g = 25\text{ }\Omega$ ,  $I_{AS} = 10\text{ A}$  (see fig. 12).
- $I_{SD} \leq 10\text{ A}$ ,  $dI/dt \leq 330\text{ A}/\mu\text{s}$ ,  $V_{DD} \leq V_{DS}$ ,  $T_J \leq 150\text{ }^\circ\text{C}$ .
- 1.6 mm from case.
- Uses IRF740A, SiHF740A data and test conditions.

\* Pb containing terminations are not RoHS compliant, exemptions may apply

THERMAL RESISTANCE RATINGS				
PARAMETER	SYMBOL	TYP.	MAX.	UNIT
Maximum Junction-to-Ambient (PCB Mounted, Steady-State) <sup>a</sup>	$R_{thJA}$	-	40	°C/W
Maximum Junction-to-Case (Drain)	$R_{thJC}$	-	1.0	

### Note

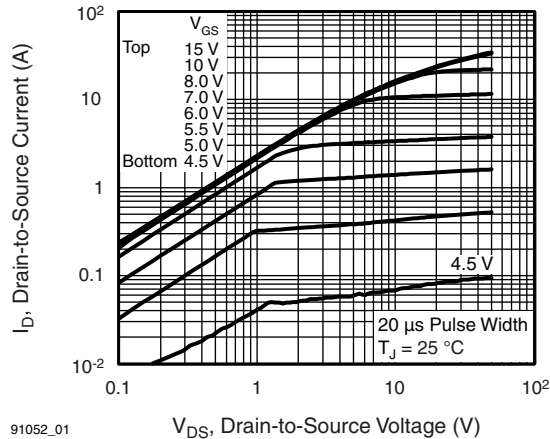
a. When mounted on 1" square PCB (FR-4 or G-10 material).

SPECIFICATIONS ( $T_J = 25\text{ }^\circ\text{C}$ , unless otherwise noted)							
PARAMETER	SYMBOL	TEST CONDITIONS	MIN.	TYP.	MAX.	UNIT	
<b>Static</b>							
Drain-Source Breakdown Voltage	$V_{DS}$	$V_{GS} = 0, I_D = 250\text{ }\mu\text{A}$	400	-	-	V	
$V_{DS}$ Temperature Coefficient	$\Delta V_{DS}/T_J$	Reference to $25\text{ }^\circ\text{C}$ , $I_D = 1\text{ mA}^d$	-	0.48	-	V/°C	
Gate-Source Threshold Voltage	$V_{GS(th)}$	$V_{DS} = V_{GS}, I_D = 250\text{ }\mu\text{A}$	2.0	-	4.0	V	
Gate-Source Leakage	$I_{GSS}$	$V_{GS} = \pm 30\text{ V}$	-	-	$\pm 100$	nA	
Zero Gate Voltage Drain Current	$I_{DSS}$	$V_{DS} = 400\text{ V}, V_{GS} = 0\text{ V}$	-	-	25	$\mu\text{A}$	
		$V_{DS} = 320\text{ V}, V_{GS} = 0\text{ V}, T_J = 125\text{ }^\circ\text{C}$	-	-	250		
Drain-Source On-State Resistance	$R_{DS(on)}$	$V_{GS} = 10\text{ V}$   $I_D = 6.0\text{ A}^b$	-	-	0.55	$\Omega$	
Forward Transconductance	$g_{fs}$	$V_{DS} = 50\text{ V}, I_D = 6.0\text{ A}^d$	4.9	-	-	S	
<b>Dynamic</b>							
Input Capacitance	$C_{iss}$	$V_{GS} = 0\text{ V}, V_{DS} = 25\text{ V}, f = 1.0\text{ MHz}$ , see fig. 5 <sup>d</sup>	-	1030	-	pF	
Output Capacitance	$C_{oss}$		-	170	-		
Reverse Transfer Capacitance	$C_{rss}$		-	7.7	-		
Output Capacitance	$C_{oss}$	$V_{GS} = 0\text{ V}$	$V_{DS} = 1.0\text{ V}, f = 1.0\text{ MHz}$	-	1490	-	
Effective Output Capacitance	$C_{oss\text{ eff.}}$		$V_{DS} = 320\text{ V}, f = 1.0\text{ MHz}$	-	52	-	
Total Gate Charge	$Q_g$	$V_{GS} = 10\text{ V}$	$I_D = 10\text{ A}, V_{DS} = 320\text{ V}$ , see fig. 6 and 13 <sup>b, d</sup>	-	-	36	nC
Gate-Source Charge	$Q_{gs}$			-	-	9.9	
Gate-Drain Charge	$Q_{gd}$			-	-	16	
Turn-On Delay Time	$t_{d(on)}$	$V_{DD} = 200\text{ V}, I_D = 10\text{ A}, R_g = 10\text{ }\Omega, R_D = 19.5\text{ }\Omega$ , see fig. 10 <sup>b, d</sup>	-	10	-	ns	
Rise Time	$t_r$		-	35	-		
Turn-Off Delay Time	$t_{d(off)}$		-	24	-		
Fall Time	$t_f$		-	22	-		
<b>Drain-Source Body Diode Characteristics</b>							
Continuous Source-Drain Diode Current	$I_S$	MOSFET symbol showing the integral reverse p - n junction diode 	-	-	10	A	
Pulsed Diode Forward Current <sup>a</sup>	$I_{SM}$		-	-	40		
Body Diode Voltage	$V_{SD}$	$T_J = 25\text{ }^\circ\text{C}, I_S = 10\text{ A}, V_{GS} = 0\text{ V}^b$	-	-	2.0	V	
Body Diode Reverse Recovery Time	$t_{rr}$	$T_J = 25\text{ }^\circ\text{C}, I_F = 10\text{ A}, di/dt = 100\text{ A}/\mu\text{s}^b, d$	-	240	360	ns	
Body Diode Reverse Recovery Charge	$Q_{rr}$		-	1.9	2.9	$\mu\text{C}$	
Forward Turn-On Time	$t_{on}$	Intrinsic turn-on time is negligible (turn-on is dominated by $L_S$ and $L_D$ )					

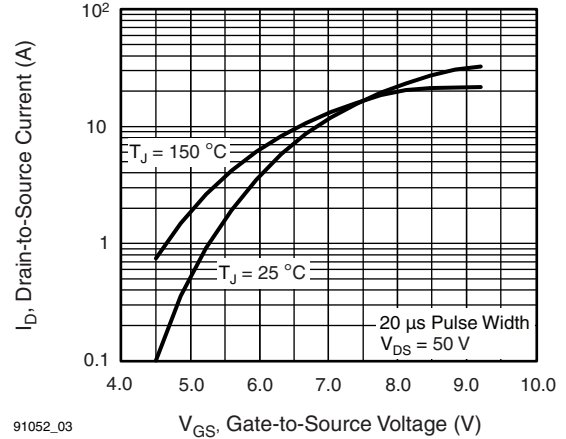
### Notes

- Repetitive rating; pulse width limited by maximum junction temperature (see fig. 11).
- Pulse width  $\leq 300\text{ }\mu\text{s}$ ; duty cycle  $\leq 2\%$ .
- $C_{oss\text{ eff.}}$  is a fixed capacitance that gives the same charging time as  $C_{oss}$  while  $V_{DS}$  is rising from 0 to 80 %  $V_{DS}$ .
- Uses IRF740A, SiHF740A data and test conditions.

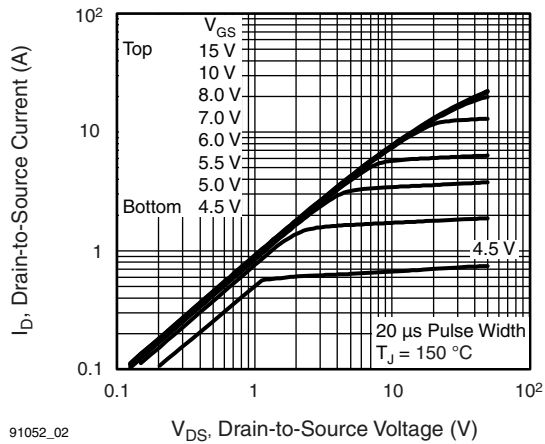
## TYPICAL CHARACTERISTICS (25 °C, unless otherwise noted)



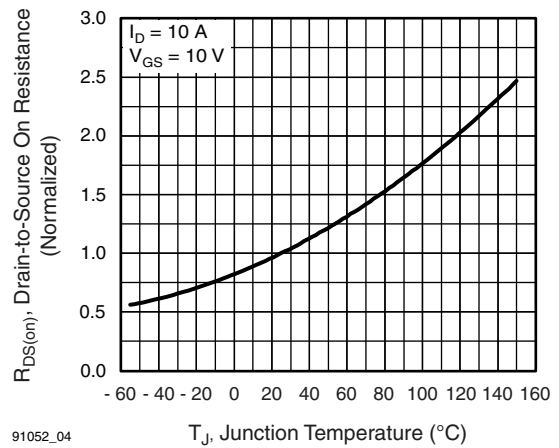
**Fig. 1 - Typical Output Characteristics**



**Fig. 3 - Typical Transfer Characteristics**



**Fig. 2 - Typical Output Characteristics**



**Fig. 4 - Normalized On-Resistance vs. Temperature**

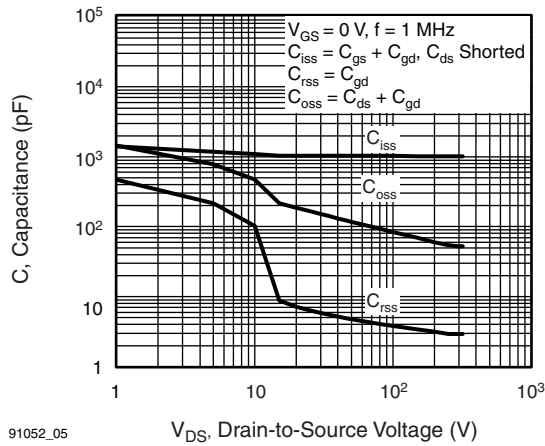


Fig. 5 - Typical Capacitance vs. Drain-to-Source Voltage

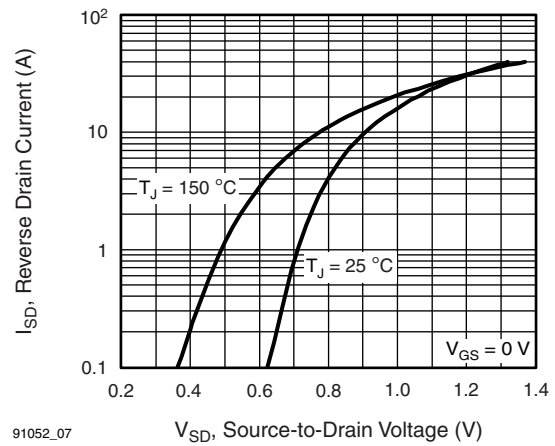


Fig. 7 - Typical Source-Drain Diode Forward Voltage

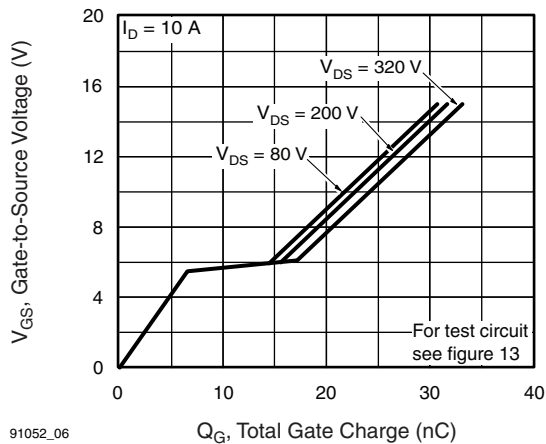


Fig. 6 - Typical Gate Charge vs. Gate-to-Source Voltage

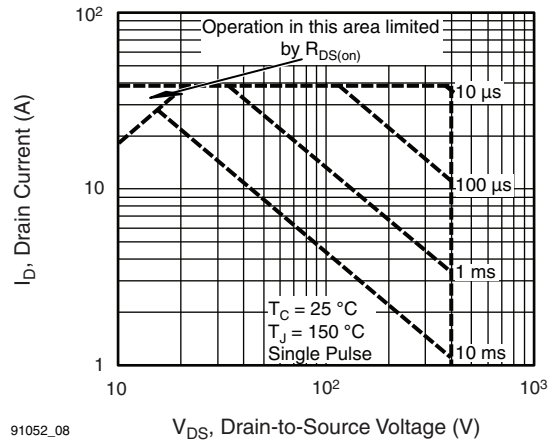
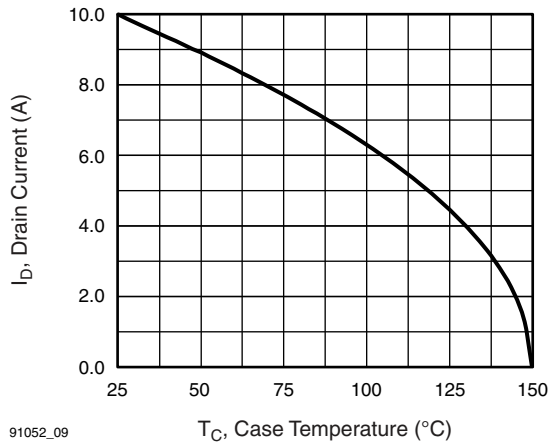
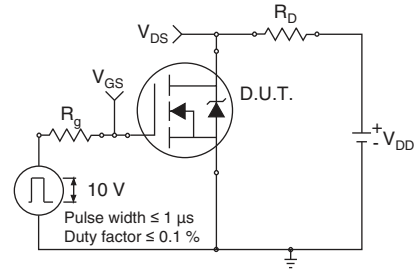


Fig. 8 - Maximum Safe Operating Area

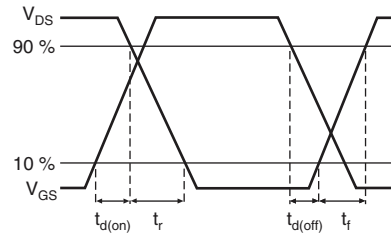


91052\_09

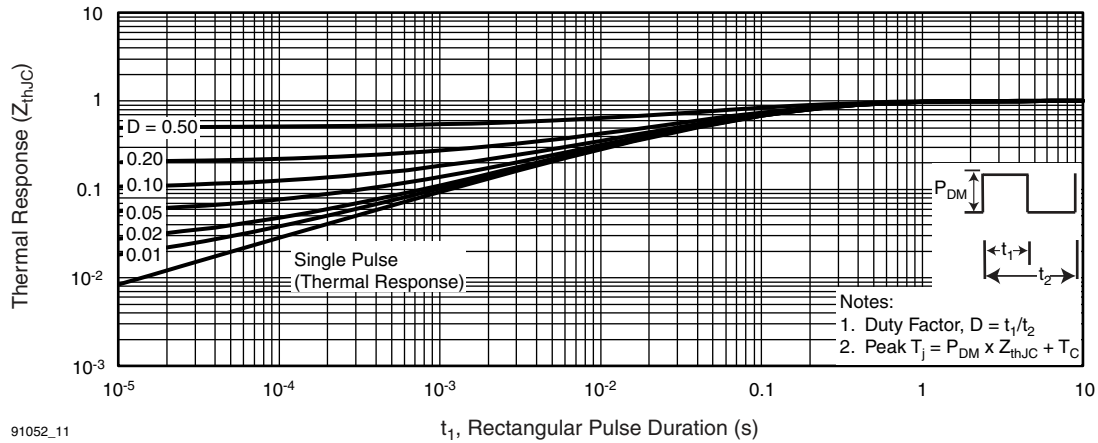
**Fig. 9 - Maximum Drain Current vs. Case Temperature**



**Fig. 10a - Switching Time Test Circuit**

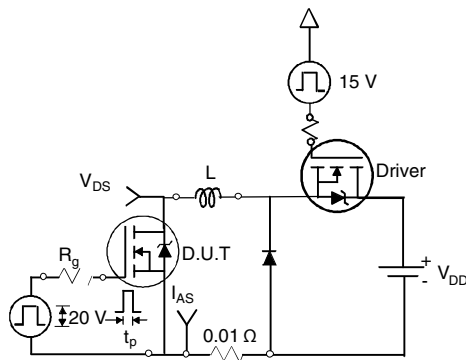


**Fig. 10b - Switching Time Waveforms**

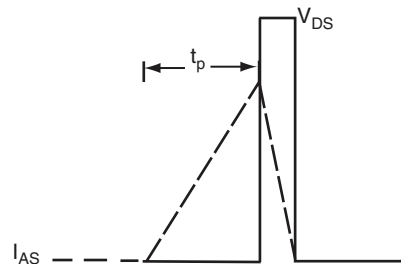


91052\_11

**Fig. 11 - Maximum Effective Transient Thermal Impedance, Junction-to-Case**



**Fig. 12a - Unclamped Inductive Test Circuit**



**Fig. 12b - Unclamped Inductive Waveforms**

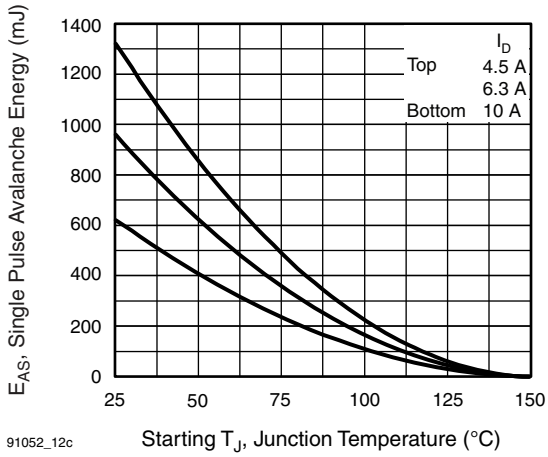


Fig. 12c - Maximum Avalanche Energy vs. Drain Current

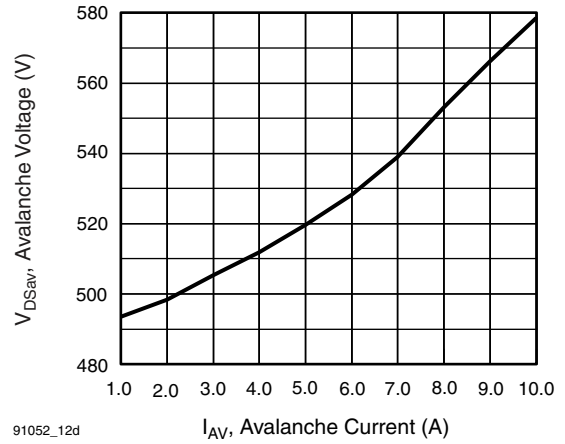


Fig. 12d - Typical Drain-to-Source Voltage vs. Avalanche Current

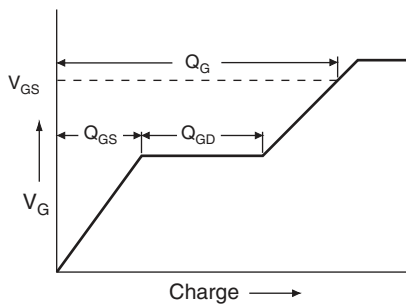


Fig. 13a - Basic Gate Charge Waveform

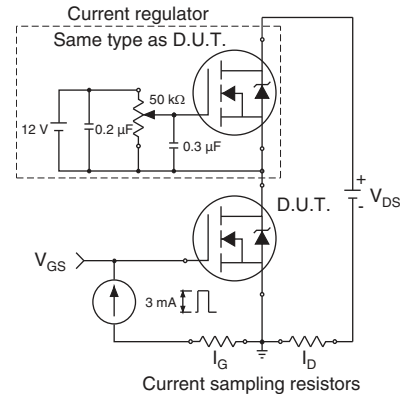
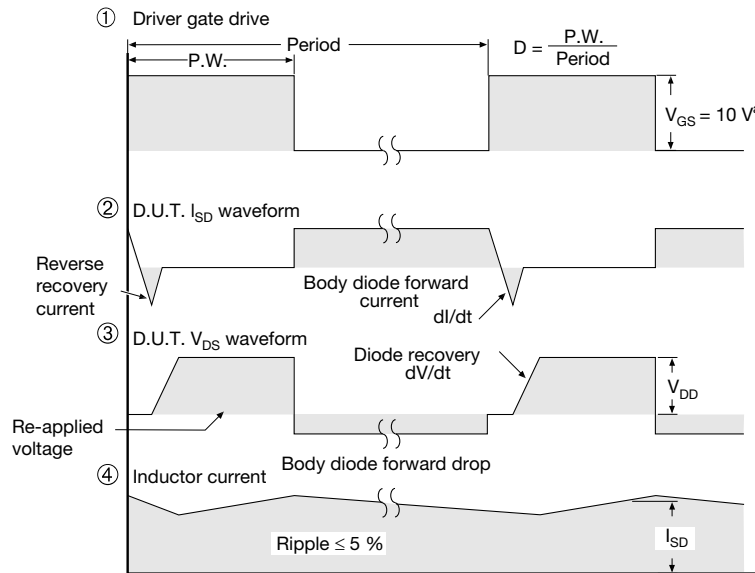
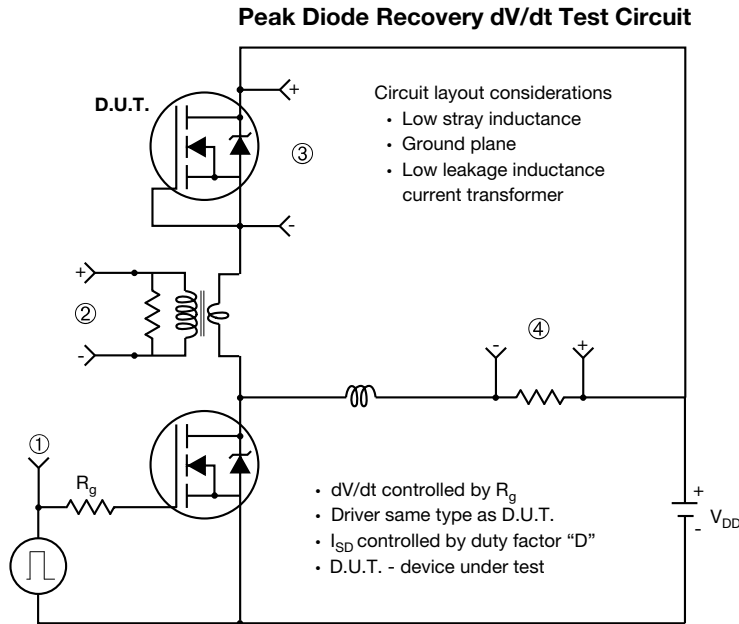


Fig. 13b - Gate Charge Test Circuit



**Note**

a.  $V_{GS} = 5 V$  for logic level devices

**Fig. 14 - For N-Channel**

Vishay Siliconix maintains worldwide manufacturing capability. Products may be manufactured at one of several qualified locations. Reliability data for Silicon Technology and Package Reliability represent a composite of all qualified locations. For related documents such as package/tape drawings, part marking, and reliability data, see [www.vishay.com/ppg?91052](http://www.vishay.com/ppg?91052).

### TO-263AB (HIGH VOLTAGE)



DIM.	MILLIMETERS		INCHES	
	MIN.	MAX.	MIN.	MAX.
A	4.06	4.83	0.160	0.190
A1	0.00	0.25	0.000	0.010
b	0.51	0.99	0.020	0.039
b1	0.51	0.89	0.020	0.035
b2	1.14	1.78	0.045	0.070
b3	1.14	1.73	0.045	0.068
c	0.38	0.74	0.015	0.029
c1	0.38	0.58	0.015	0.023
c2	1.14	1.65	0.045	0.065
D	8.38	9.65	0.330	0.380

DIM.	MILLIMETERS		INCHES	
	MIN.	MAX.	MIN.	MAX.
D1	6.86	-	0.270	-
E	9.65	10.67	0.380	0.420
E1	6.22	-	0.245	-
e	2.54 BSC		0.100 BSC	
H	14.61	15.88	0.575	0.625
L	1.78	2.79	0.070	0.110
L1	-	1.65	-	0.066
L2	-	1.78	-	0.070
L3	0.25 BSC		0.010 BSC	
L4	4.78	5.28	0.188	0.208

ECN: S-82110-Rev. A, 15-Sep-08  
DWG: 5970

#### Notes

1. Dimensioning and tolerancing per ASME Y14.5M-1994.
2. Dimensions are shown in millimeters (inches).
3. Dimension D and E do not include mold flash. Mold flash shall not exceed 0.127 mm (0.005") per side. These dimensions are measured at the outmost extremes of the plastic body at datum A.
4. Thermal PAD contour optional within dimension E, L1, D1 and E1.
5. Dimension b1 and c1 apply to base metal only.
6. Datum A and B to be determined at datum plane H.
7. Outline conforms to JEDEC outline to TO-263AB.

## I<sup>2</sup>PAK (TO-262) (HIGH VOLTAGE)



DIM.	MILLIMETERS		INCHES	
	MIN.	MAX.	MIN.	MAX.
A	4.06	4.83	0.160	0.190
A1	2.03	3.02	0.080	0.119
b	0.51	0.99	0.020	0.039
b1	0.51	0.89	0.020	0.035
b2	1.14	1.78	0.045	0.070
b3	1.14	1.73	0.045	0.068
c	0.38	0.74	0.015	0.029
c1	0.38	0.58	0.015	0.023
c2	1.14	1.65	0.045	0.065

DIM.	MILLIMETERS		INCHES	
	MIN.	MAX.	MIN.	MAX.
D	8.38	9.65	0.330	0.380
D1	6.86	-	0.270	-
E	9.65	10.67	0.380	0.420
E1	6.22	-	0.245	-
e	2.54 BSC		0.100 BSC	
L	13.46	14.10	0.530	0.555
L1	-	1.65	-	0.065
L2	3.56	3.71	0.140	0.146

ECN: S-82442-Rev. A, 27-Oct-08  
DWG: 5977

### Notes

1. Dimensioning and tolerancing per ASME Y14.5M-1994.
2. Dimension D and E do not include mold flash. Mold flash shall not exceed 0.127 mm per side. These dimensions are measured at the outmost extremes of the plastic body.
3. Thermal pad contour optional within dimension E, L1, D1, and E1.
4. Dimension b1 and c1 apply to base metal only.



## **Disclaimer**

ALL PRODUCT, PRODUCT SPECIFICATIONS AND DATA ARE SUBJECT TO CHANGE WITHOUT NOTICE TO IMPROVE RELIABILITY, FUNCTION OR DESIGN OR OTHERWISE.

Vishay Intertechnology, Inc., its affiliates, agents, and employees, and all persons acting on its or their behalf (collectively, "Vishay"), disclaim any and all liability for any errors, inaccuracies or incompleteness contained in any datasheet or in any other disclosure relating to any product.

Vishay makes no warranty, representation or guarantee regarding the suitability of the products for any particular purpose or the continuing production of any product. To the maximum extent permitted by applicable law, Vishay disclaims (i) any and all liability arising out of the application or use of any product, (ii) any and all liability, including without limitation special, consequential or incidental damages, and (iii) any and all implied warranties, including warranties of fitness for particular purpose, non-infringement and merchantability.

Statements regarding the suitability of products for certain types of applications are based on Vishay's knowledge of typical requirements that are often placed on Vishay products in generic applications. Such statements are not binding statements about the suitability of products for a particular application. It is the customer's responsibility to validate that a particular product with the properties described in the product specification is suitable for use in a particular application. Parameters provided in datasheets and / or specifications may vary in different applications and performance may vary over time. All operating parameters, including typical parameters, must be validated for each customer application by the customer's technical experts. Product specifications do not expand or otherwise modify Vishay's terms and conditions of purchase, including but not limited to the warranty expressed therein.

Except as expressly indicated in writing, Vishay products are not designed for use in medical, life-saving, or life-sustaining applications or for any other application in which the failure of the Vishay product could result in personal injury or death. Customers using or selling Vishay products not expressly indicated for use in such applications do so at their own risk. Please contact authorized Vishay personnel to obtain written terms and conditions regarding products designed for such applications.

No license, express or implied, by estoppel or otherwise, to any intellectual property rights is granted by this document or by any conduct of Vishay. Product names and markings noted herein may be trademarks of their respective owners.

## Looking for pricing, stock, or lifecycle information?

Click below to explore more details on WIN SOURCE:

 [View IRF740ASTRLPBF on WIN SOURCE](#)

 [Vishay Information](#)

## Optimize Your Supply Chain with WIN SOURCE Solutions

-  Global Sourcing Solution
-  Obsolete Management
-  Cost Control Management
-  Shortage Management
-  Alternative Solution
-  Excess Inventory Management