



**THE DATASHEET OF  
IRF7422D2PBF**



# IRF7422D2PbF

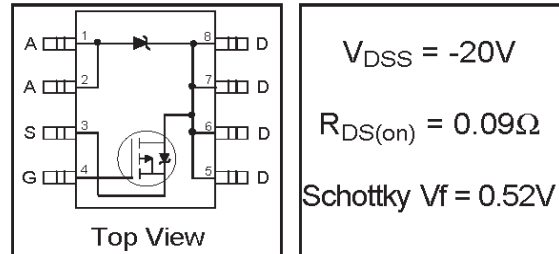
## FETKY™ MOSFET & Schottky Diode

- Co-packaged HEXFET® Power MOSFET and Schottky Diode
- Ideal For Buck Regulator Applications
- P-Channel HEXFET
- Low  $V_F$  Schottky Rectifier
- Generation 5 Technology
- SO-8 Footprint
- Lead-Free

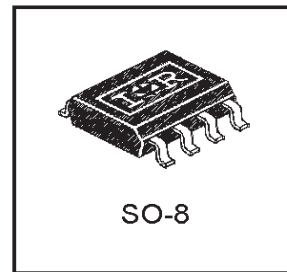
### Description

The FETKY™ family of Co-packaged HEXFETs and Schottky diodes offer the designer an innovative board space saving solution for switching regulator and power management applications. Generation 5 HEXFETs utilize advanced processing techniques to achieve extremely low on-resistance per silicon area. Combining this technology with International Rectifier's low forward drop Schottky rectifiers results in an extremely efficient device suitable for use in a wide variety of portable electronics applications.

The SO-8 has been modified through a customized leadframe for enhanced thermal characteristics. The SO-8 package is designed for vapor phase, infrared or wave soldering techniques.



$V_{DSS} = -20V$   
 $R_{DS(on)} = 0.09\Omega$   
 Schottky  $V_f = 0.52V$



### Absolute Maximum Ratings

Parameter	Maximum	Units
$I_D @ T_A = 25^\circ C$	-4.3	A
$I_D @ T_A = 70^\circ C$	-3.4	
$I_{DM}$	-33	
$P_D @ T_A = 25^\circ C$	2.0	W
$P_D @ T_A = 70^\circ C$	1.3	
	16	mW/°C
$V_{GS}$	$\pm 12$	V
$dv/dt$	-5.0	V/ns
$T_J, T_{STG}$	-55 to +150	°C

### Thermal Resistance Ratings

Parameter	Maximum	Units
$R_{\theta JA}$	62.5	°C/W

### Notes:

- ① Repetitive rating – pulse width limited by max. junction temperature (see fig. 11)
- ②  $I_{SD} \leq -2.2A$ ,  $di/dt \leq -50A/\mu s$ ,  $V_{DD} \leq V_{(BR)DSS}$ ,  $T_J \leq 150^\circ C$
- ③ Pulse width  $\leq 300\mu s$  – duty cycle  $\leq 2\%$
- ④ Surface mounted on FR-4 board,  $t \leq 10sec$ .

## MOSFET Electrical Characteristics @ T<sub>J</sub> = 25°C (unless otherwise specified)

	Parameter	Min.	Typ.	Max.	Units	Conditions
V <sub>(BR)DSS</sub>	Drain-to-Source Breakdown Voltage	-20	—	—	V	V <sub>GS</sub> = 0V, I <sub>D</sub> = -250μA
R <sub>DS(on)</sub>	Static Drain-to-Source On-Resistance	—	0.07	0.09	Ω	V <sub>GS</sub> = -4.5V, I <sub>D</sub> = -2.2A ③
		—	0.115	0.14		V <sub>GS</sub> = -2.7V, I <sub>D</sub> = -1.8A ③
V <sub>GS(th)</sub>	Gate Threshold Voltage	-0.70	—	—	V	V <sub>DS</sub> = V <sub>GS</sub> , I <sub>D</sub> = -250μA
g <sub>fs</sub>	Forward Transconductance	4.0	—	—	S	V <sub>DS</sub> = -16V, I <sub>D</sub> = -2.2A
I <sub>DSS</sub>	Drain-to-Source Leakage Current	—	—	-1.0	μA	V <sub>DS</sub> = -16V, V <sub>GS</sub> = 0V
		—	—	-25		V <sub>DS</sub> = -16V, V <sub>GS</sub> = 0V, T <sub>J</sub> = 125°C
I <sub>GSS</sub>	Gate-to-Source Forward Leakage	—	—	-100	nA	V <sub>GS</sub> = -12V
	Gate-to-Source Reverse Leakage	—	—	100		V <sub>GS</sub> = 12V
Q <sub>g</sub>	Total Gate Charge	—	15	22	nC	I <sub>D</sub> = -2.2A
Q <sub>gs</sub>	Gate-to-Source Charge	—	2.2	3.3		V <sub>DS</sub> = -16V
Q <sub>gd</sub>	Gate-to-Drain ("Miller") Charge	—	6.0	9.0		V <sub>GS</sub> = -4.5V, See Fig. 6 and 9 ③
t <sub>d(on)</sub>	Turn-On Delay Time	—	8.4	—	ns	V <sub>DD</sub> = -10V
t <sub>r</sub>	Rise Time	—	26	—		I <sub>D</sub> = -2.2A
t <sub>d(off)</sub>	Turn-Off Delay Time	—	51	—		R <sub>G</sub> = 6.0Ω
t <sub>f</sub>	Fall Time	—	33	—		R <sub>D</sub> = 4.5Ω, See Fig. 10 ③
C <sub>iss</sub>	Input Capacitance	—	610	—	pF	V <sub>GS</sub> = 0V
C <sub>oss</sub>	Output Capacitance	—	310	—		V <sub>DS</sub> = -15V
C <sub>rss</sub>	Reverse Transfer Capacitance	—	170	—		f = 1.0MHz, See Fig. 5

## MOSFET Source-Drain Ratings and Characteristics

	Parameter	Min.	Typ.	Max.	Units	Conditions
I <sub>S</sub>	Continuous Source Current (Body Diode)	—	—	-2.5	A	
I <sub>SM</sub>	Pulsed Source Current (Body Diode)	—	—	-17		
V <sub>SD</sub>	Body Diode Forward Voltage	—	—	-1.0	V	T <sub>J</sub> = 25°C, I <sub>S</sub> = -1.8A, V <sub>GS</sub> = 0V
t <sub>rr</sub>	Reverse Recovery Time (Body Diode)	—	56	84	ns	T <sub>J</sub> = 25°C, I <sub>F</sub> = -2.2A
Q <sub>rr</sub>	Reverse Recovery Charge	—	71	110	nC	di/dt = -100A/μs ③

## Schottky Diode Maximum Ratings

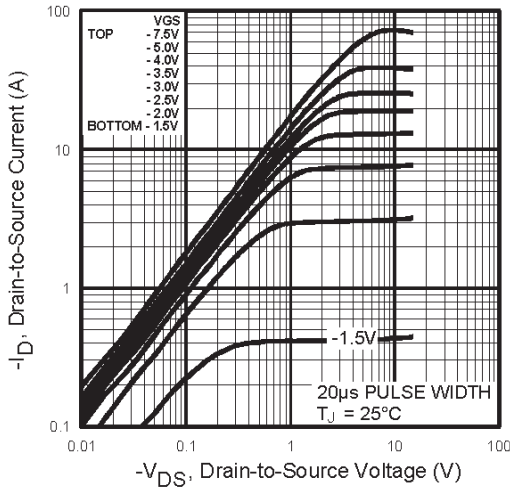
	Parameter	Max.	Units	Conditions
I <sub>f</sub> (av)	Max. Average Forward Current	2.8	A	50% Duty Cycle. Rectangular Wave, T <sub>c</sub> = 25°C
		1.8		50% Duty Cycle. Rectangular Wave, T <sub>c</sub> = 70°C
I <sub>SM</sub>	Max. peak one cycle Non-repetitive Surge current	200	A	5μs sine or 3μs Rect. pulse
		20		10ms sine or 6ms Rect. pulse
				Following any rated load condition & with V <sub>rrm</sub> applied

## Schottky Diode Electrical Specifications

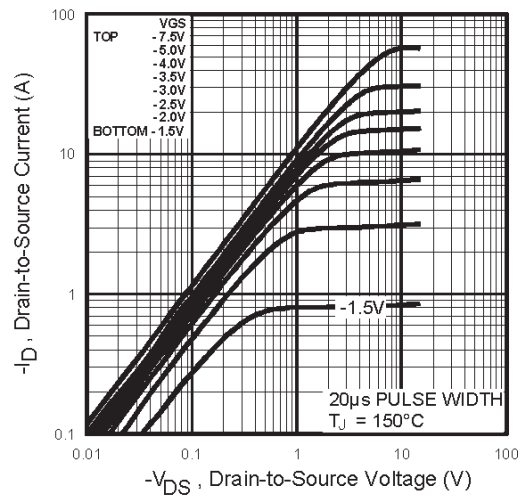
	Parameter	Max.	Units	Conditions
V <sub>fm</sub>	Max. Forward voltage drop	0.57	V	I <sub>f</sub> = 3.0, T <sub>J</sub> = 25°C
		0.77		I <sub>f</sub> = 6.0, T <sub>J</sub> = 25°C
		0.52		I <sub>f</sub> = 3.0, T <sub>J</sub> = 125°C
		0.79		I <sub>f</sub> = 6.0, T <sub>J</sub> = 125°C
I <sub>rm</sub>	Max. Reverse Leakage current	0.13	mA	V <sub>r</sub> = 20V, T <sub>J</sub> = 25°C
		18		T <sub>J</sub> = 125°C
C <sub>t</sub>	Max. Junction Capacitance	310	pF	V <sub>r</sub> = 5Vdc ( 100kHz to 1 MHz) 25°C
dv/dt	Max. Voltage Rate of Charge	4900	V/μs	Rated V <sub>r</sub>

( HEXFET is the reg. TM for International Rectifier Power MOSFET's )

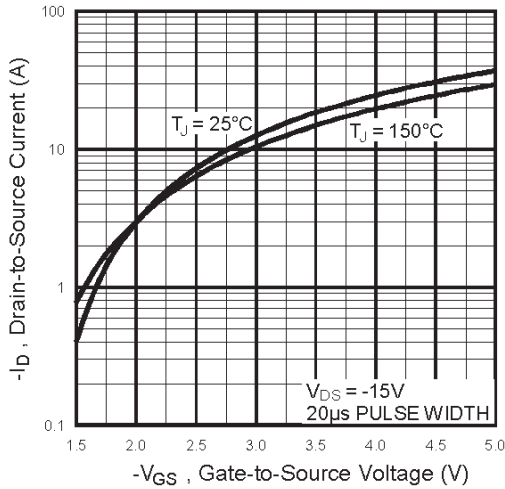
## Power Mosfet Characteristics



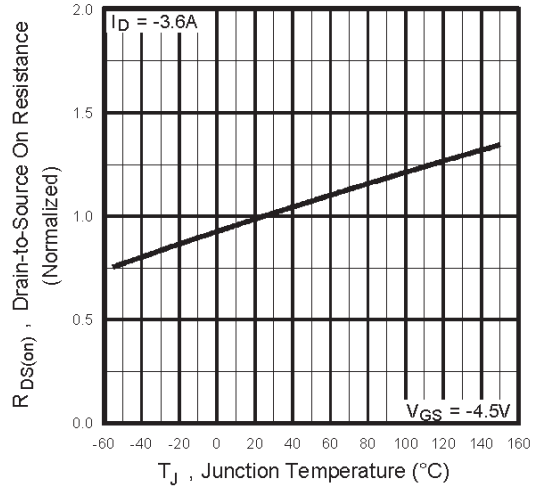
**Fig 1.** Typical Output Characteristics



**Fig 2.** Typical Output Characteristics

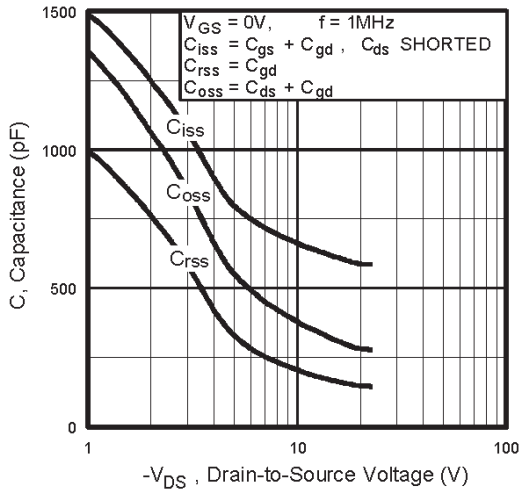


**Fig 3.** Typical Transfer Characteristics

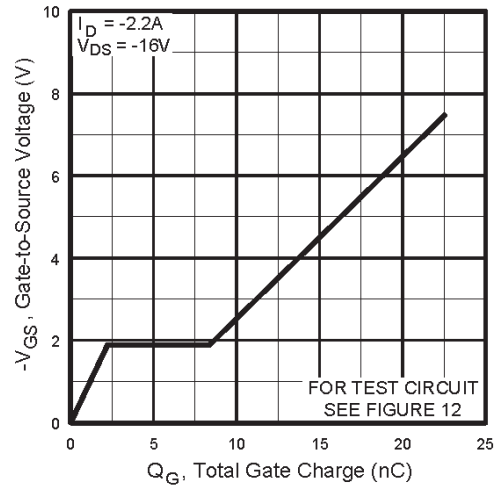


**Fig 4.** Normalized On-Resistance Vs. Temperature

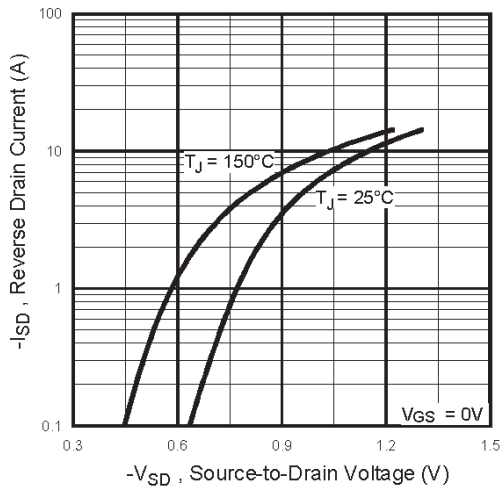
## Power Mosfet Characteristics



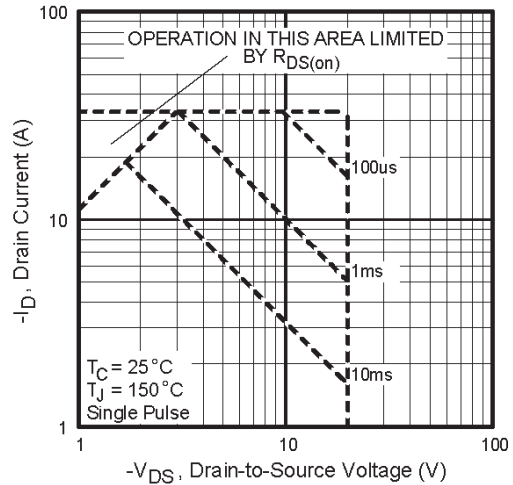
**Fig 5.** Typical Capacitance Vs. Drain-to-Source Voltage



**Fig 6.** Typical Gate Charge Vs. Gate-to-Source Voltage

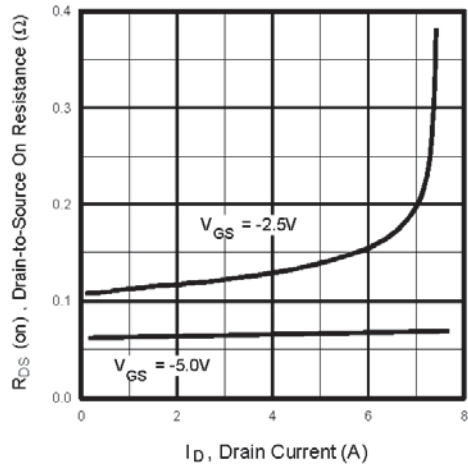
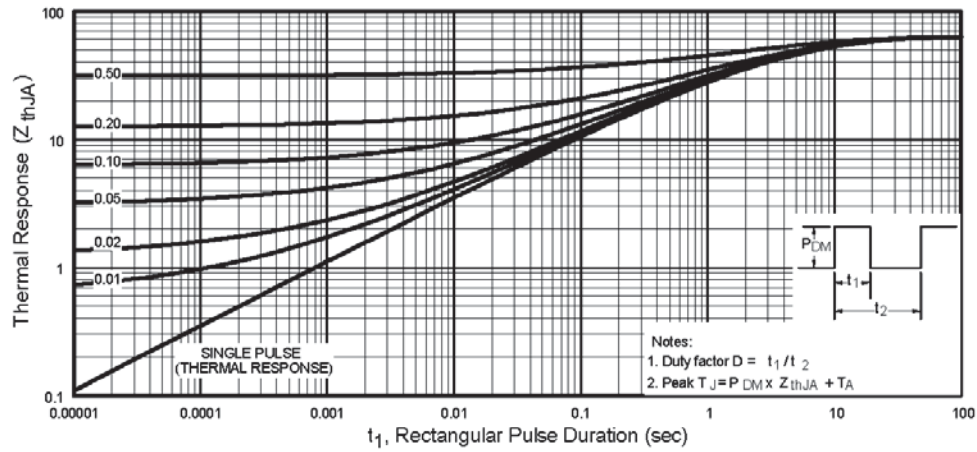


**Fig 7.** Typical Source-Drain Diode Forward Voltage

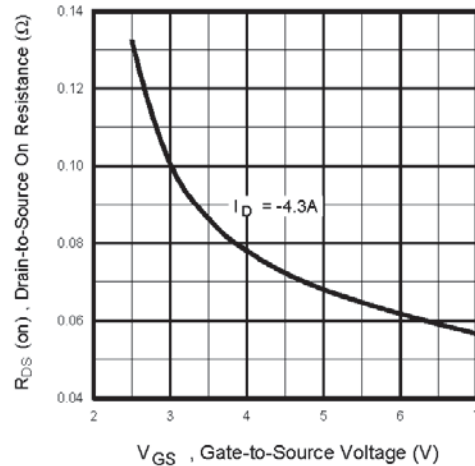


**Fig 8.** Maximum Safe Operating Area

## Power Mosfet Characteristics

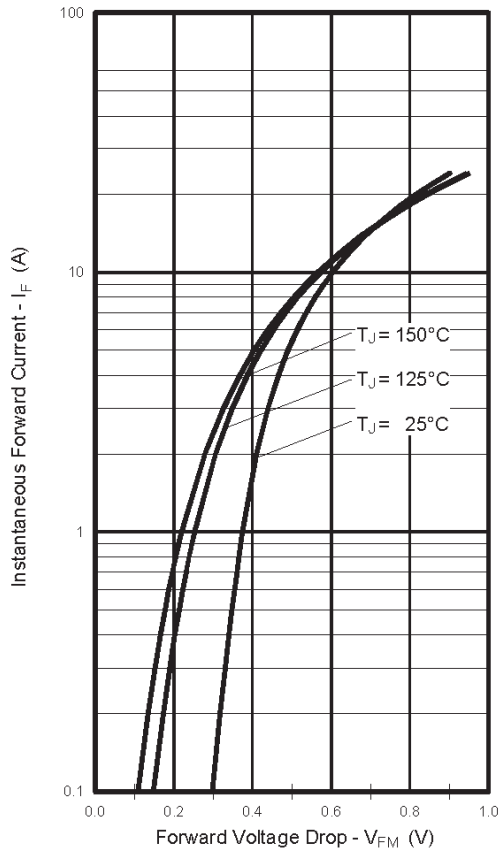


**Fig 10.** Typical On-Resistance Vs. Drain Current

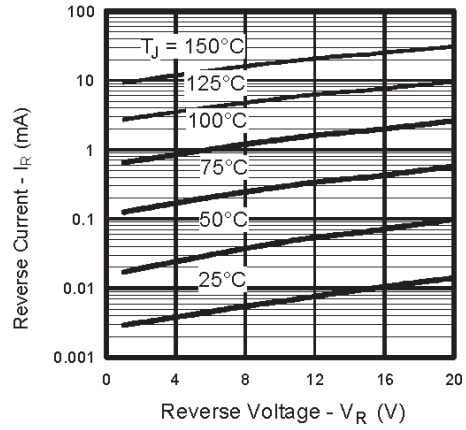


**Fig 11.** Typical On-Resistance Vs. Gate Voltage

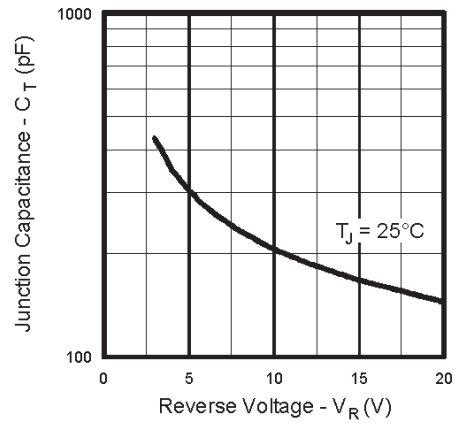
## Schottky Diode Characteristics



**Fig. 12** - Typical Forward Voltage Drop Characteristics

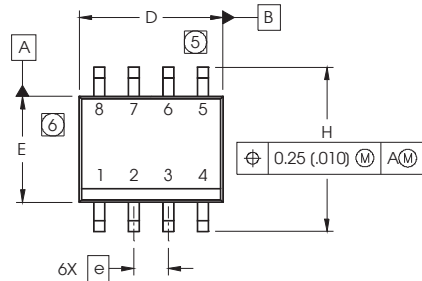


**Fig. 13** - Typical Values of Reverse Current Vs. Reverse Voltage

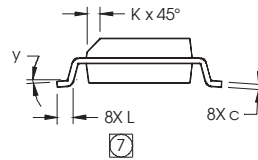
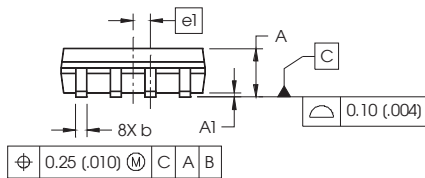


**Fig. 14** - Typical Junction Capacitance Vs. Reverse Voltage

## SO-8 (Fetky) Package Outline



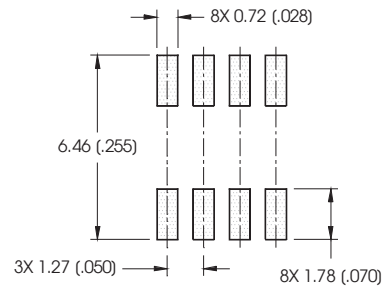
DIM	INCHES		MILLIMETERS	
	MIN	MAX	MIN	MAX
A	.0532	.0688	1.35	1.75
A1	.0040	.0098	0.10	0.25
b	.013	.020	0.33	0.51
c	.0075	.0098	0.19	0.25
D	.189	.1968	4.80	5.00
E	.1497	.1574	3.80	4.00
e	.050 BASIC		1.27 BASIC	
e1	.025 BASIC		0.635 BASIC	
H	.2284	.2440	5.80	6.20
K	.0099	.0196	0.25	0.50
L	.016	.050	0.40	1.27
y	0°	8°	0°	8°



**NOTES:**

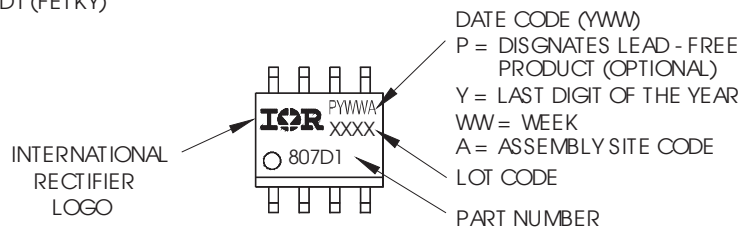
1. DIMENSIONING & TOLERANCING PER ASME Y14.5M-1994.
2. CONTROLLING DIMENSION: MILLIMETER
3. DIMENSIONS ARE SHOWN IN MILLIMETERS (INCHES).
4. OUTLINE CONFORMS TO JEDEC OUTLINE MS-012AA.
- ⑤ DIMENSION DOES NOT INCLUDE MOLD PROTRUSIONS. MOLD PROTRUSIONS NOT TO EXCEED 0.15 (.006).
- ⑥ DIMENSION DOES NOT INCLUDE MOLD PROTRUSIONS. MOLD PROTRUSIONS NOT TO EXCEED 0.25 (.010).
- ⑦ DIMENSION IS THE LENGTH OF LEAD FOR SOLDERING TO A SUBSTRATE.

**FOOTPRINT**



## SO-8 (Fetky) Part Marking Information

EXAMPLE: THIS IS AN IRF7807D1 (FETKY)

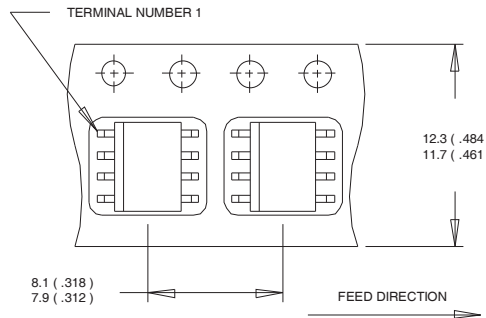


# IRF7422D2PbF

International  
**IR** Rectifier

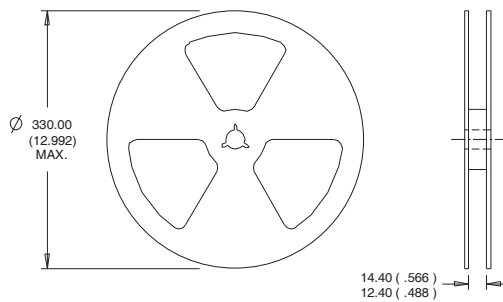
## SO-8 Tape and Reel

Dimensions are shown in millimeters (inches)



**NOTES:**

1. CONTROLLING DIMENSION : MILLIMETER.
2. ALL DIMENSIONS ARE SHOWN IN MILLIMETERS(INCHES).
3. OUTLINE CONFORMS TO EIA-481 & EIA-541.



**NOTES :**

1. CONTROLLING DIMENSION : MILLIMETER.
2. OUTLINE CONFORMS TO EIA-481 & EIA-541.

Data and specifications subject to change without notice.  
This product has been designed and qualified for the Consumer market.  
Qualifications Standards can be found on IR's Web site.

International  
**IR** Rectifier

**IR WORLD HEADQUARTERS:** 233 Kansas St., El Segundo, California 90245, USA Tel: (310) 252-7105  
TAC Fax: (310) 252-7903

Visit us at [www.irf.com](http://www.irf.com) for sales contact information.10/04

[www.irf.com](http://www.irf.com)

## Looking for pricing, stock, or lifecycle information?

Click below to explore more details on WIN SOURCE:

 [View IRF7422D2PBF](#) on WIN SOURCE

 [Infineon Technologies](#) Information

## Optimize Your Supply Chain with WIN SOURCE Solutions

-  Global Sourcing Solution
-  Obsolete Management
-  Cost Control Management
-  Shortage Management
-  Alternative Solution
-  Excess Inventory Management