



**THE DATASHEET OF
IRF7452PBF**



IRF7452PbF

SMPS MOSFET

HEXFET® Power MOSFET

Applications

- High frequency DC-DC converters
- Lead-Free

V_{DSS}	$R_{DS(on) \max}$	I_D
100V	0.060Ω	4.5A

Benefits

- Low Gate to Drain Charge to Reduce Switching Losses
- Fully Characterized Capacitance Including Effective C_{OSS} to Simplify Design. (See App. Note AN1001)
- Fully Characterized Avalanche Voltage and Current

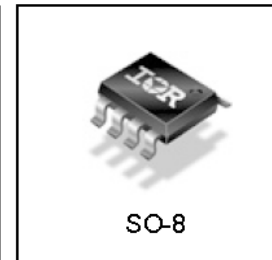
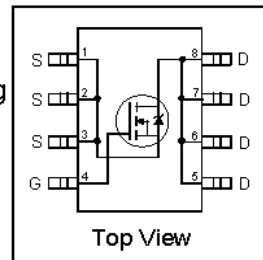

Absolute Maximum Ratings

	Parameter	Max.	Units
$I_D @ T_A = 25^\circ\text{C}$	Continuous Drain Current, $V_{GS} @ 10\text{V}$	4.5	A
$I_D @ T_A = 70^\circ\text{C}$	Continuous Drain Current, $V_{GS} @ 10\text{V}$	3.6	
I_{DM}	Pulsed Drain Current ①	36	
$P_D @ T_A = 25^\circ\text{C}$	Power Dissipation	2.5	W
	Linear Derating Factor	0.02	W/°C
V_{GS}	Gate-to-Source Voltage	± 30	V
dv/dt	Peak Diode Recovery dv/dt ②	3.5	V/ns
T_J	Operating Junction and	-55 to + 150	°C
T_{STG}	Storage Temperature Range		
	Soldering Temperature, for 10 seconds	300 (1.6mm from case)	

Typical SMPS Topologies

- Telecom 48V input DC-DC with Half Bridge Primary or Datacom 28V input with Passive Reset Forward Converter Primary

Notes ① through ⑥ are on page 8

IRF7452PbF

International
IR Rectifier

Static @ $T_J = 25^\circ\text{C}$ (unless otherwise specified)

	Parameter	Min.	Typ.	Max.	Units	Conditions
$V_{(BR)DSS}$	Drain-to-Source Breakdown Voltage	100	—	—	V	$V_{GS} = 0V, I_D = 250\mu A$
$\Delta V_{(BR)DSS}/\Delta T_J$	Breakdown Voltage Temp. Coefficient	—	0.11	—	V/°C	Reference to $25^\circ\text{C}, I_D = 1mA$ ⑥
$R_{DS(on)}$	Static Drain-to-Source On-Resistance	—	—	0.060	Ω	$V_{GS} = 10V, I_D = 2.7A$ ④
$V_{GS(th)}$	Gate Threshold Voltage	3.0	—	5.5	V	$V_{DS} = V_{GS}, I_D = 250\mu A$
I_{DSS}	Drain-to-Source Leakage Current	—	—	25	μA	$V_{DS} = 100V, V_{GS} = 0V$
		—	—	250		$V_{DS} = 80V, V_{GS} = 0V, T_J = 150^\circ\text{C}$
I_{GSS}	Gate-to-Source Forward Leakage	—	—	100	nA	$V_{GS} = 24V$
	Gate-to-Source Reverse Leakage	—	—	-100		$V_{GS} = -24V$

Dynamic @ $T_J = 25^\circ\text{C}$ (unless otherwise specified)

	Parameter	Min.	Typ.	Max.	Units	Conditions
g_{fs}	Forward Transconductance	3.4	—	—	S	$V_{DS} = 50V, I_D = 2.7A$
Q_g	Total Gate Charge	—	33	50	nC	$I_D = 2.7A$
Q_{gs}	Gate-to-Source Charge	—	7.3	11		$V_{DS} = 80V$
Q_{gd}	Gate-to-Drain ("Miller") Charge	—	16	24		$V_{GS} = 10V, \text{④}$
$t_{d(on)}$	Turn-On Delay Time	—	9.5	—	ns	$V_{DD} = 50V$
t_r	Rise Time	—	11	—		$I_D = 2.7A$
$t_{d(off)}$	Turn-Off Delay Time	—	16	—		$R_G = 6.0\Omega$
t_f	Fall Time	—	13	—		$V_{GS} = 10V, \text{④}$
C_{iss}	Input Capacitance	—	930	—	pF	$V_{GS} = 0V$
C_{oss}	Output Capacitance	—	300	—		$V_{DS} = 25V$
C_{rss}	Reverse Transfer Capacitance	—	84	—		$f = 1.0MHz$
C_{oss}	Output Capacitance	—	1370	—		$V_{GS} = 0V, V_{DS} = 1.0V, f = 1.0MHz$
C_{oss}	Output Capacitance	—	170	—		$V_{GS} = 0V, V_{DS} = 80V, f = 1.0MHz$
$C_{oss \text{ eff.}}$	Effective Output Capacitance	—	280	—		$V_{GS} = 0V, V_{DS} = 0V \text{ to } 80V \text{ ⑤}$

Avalanche Characteristics

	Parameter	Typ.	Max.	Units
E_{AS}	Single Pulse Avalanche Energy②	—	200	mJ
I_{AR}	Avalanche Current①	—	4.5	A
E_{AR}	Repetitive Avalanche Energy①	—	0.25	mJ

Thermal Resistance

	Parameter	Typ.	Max.	Units
$R_{\theta JA}$	Maximum Junction-to-Ambient⑥	—	50	°C/W

Diode Characteristics

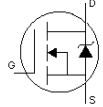
	Parameter	Min.	Typ.	Max.	Units	Conditions
I_S	Continuous Source Current (Body Diode)	—	—	2.3	A	MOSFET symbol showing the integral reverse p-n junction diode. 
I_{SM}	Pulsed Source Current (Body Diode) ①	—	—	36		
V_{SD}	Diode Forward Voltage	—	—	1.3	V	$T_J = 25^\circ\text{C}, I_S = 2.7A, V_{GS} = 0V$ ④
t_{rr}	Reverse Recovery Time	—	77	120	ns	$T_J = 25^\circ\text{C}, I_F = 2.7A$
Q_{rr}	Reverse Recovery Charge	—	270	410	nC	$di/dt = 100A/\mu s$ ④

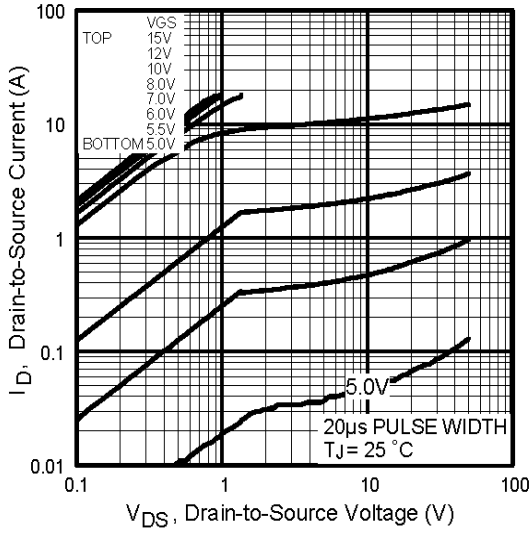

Fig 1. Typical Output Characteristics

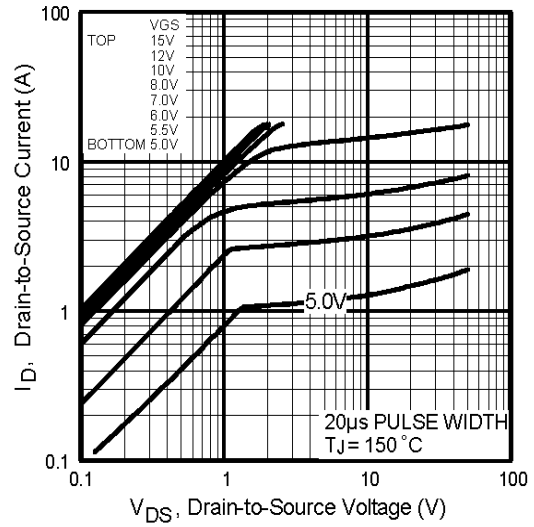

Fig 2. Typical Output Characteristics

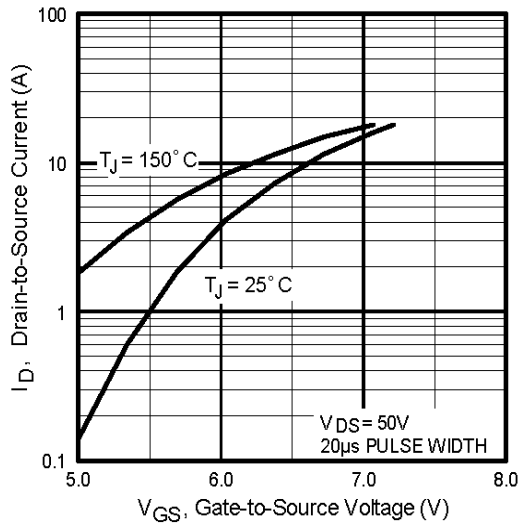

Fig 3. Typical Transfer Characteristics

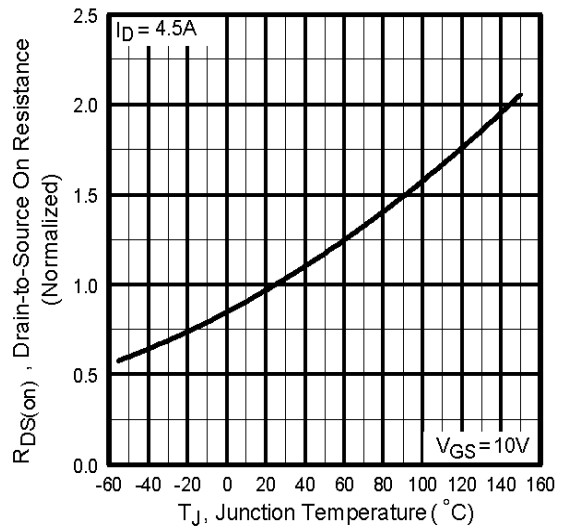

Fig 4. Normalized On-Resistance Vs. Temperature

IRF7452PbF

International
IR Rectifier

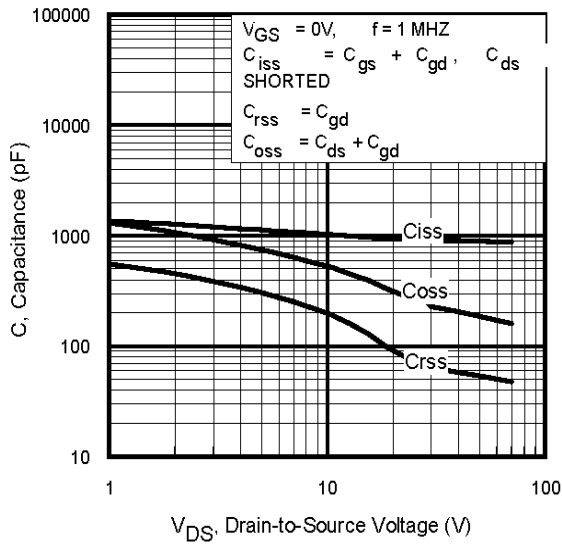

Fig 5. Typical Capacitance Vs. Drain-to-Source Voltage

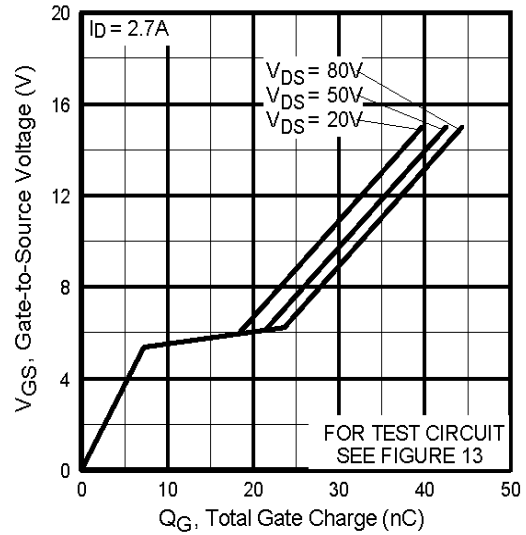

Fig 6. Typical Gate Charge Vs. Gate-to-Source Voltage

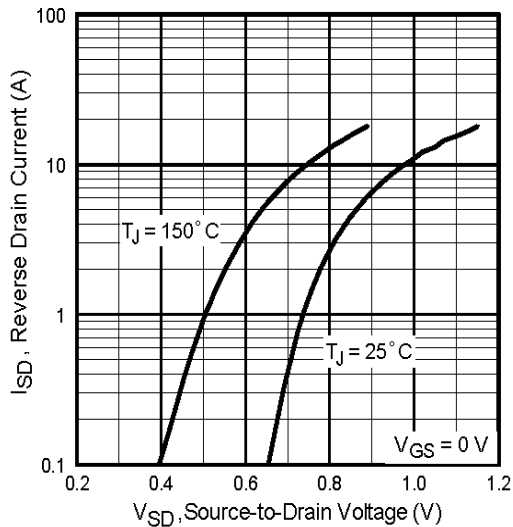

Fig 7. Typical Source-Drain Diode Forward Voltage

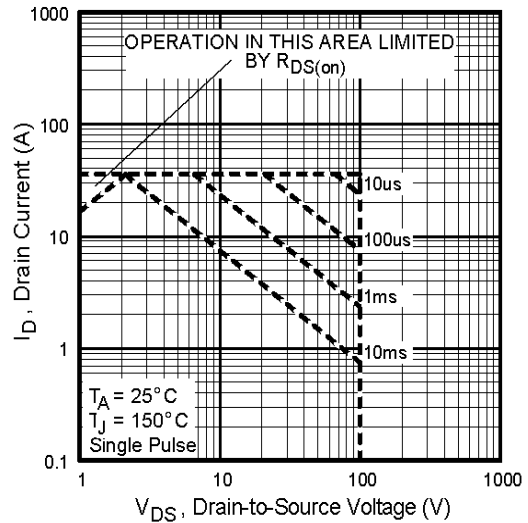

Fig 8. Maximum Safe Operating Area

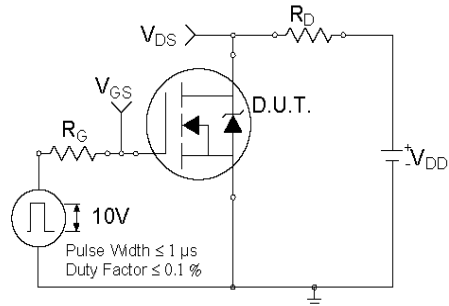
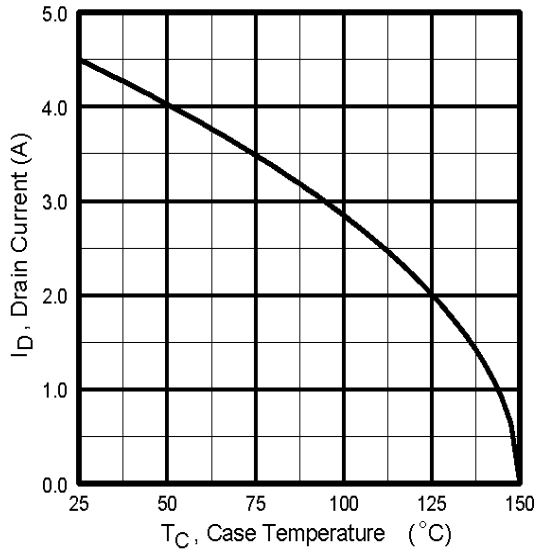

Fig 10a. Switching Time Test Circuit

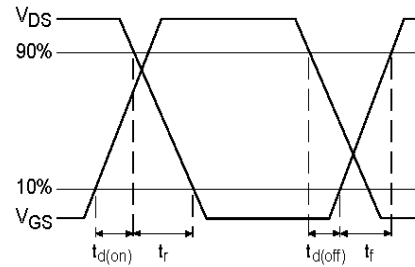

Fig 10b. Switching Time Waveforms

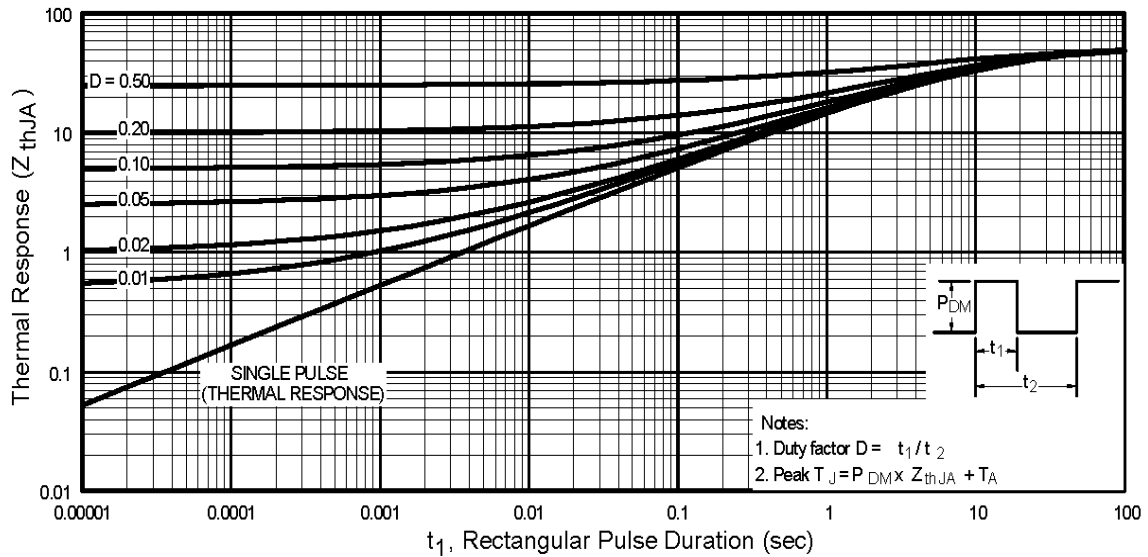

Fig 10. Maximum Effective Transient Thermal Impedance, Junction-to-Ambient
www.irf.com

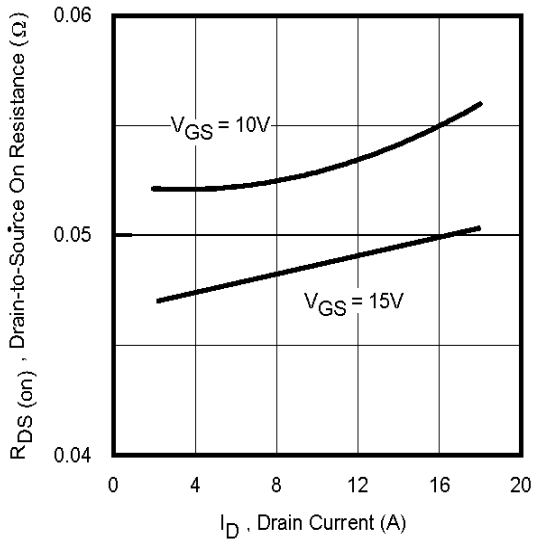

Fig 12. On-Resistance Vs. Drain Current

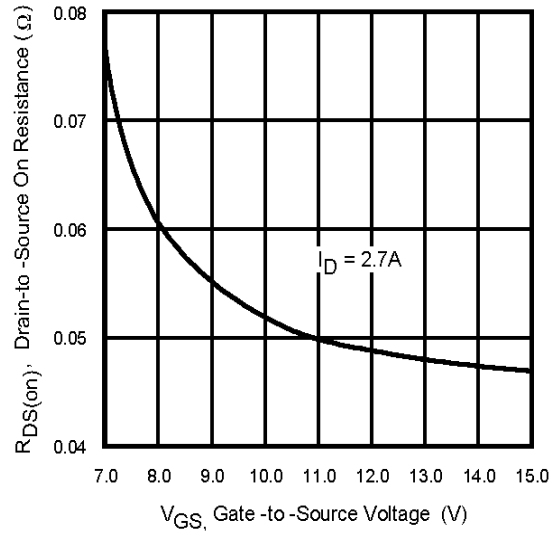

Fig 13. On-Resistance Vs. Gate Voltage

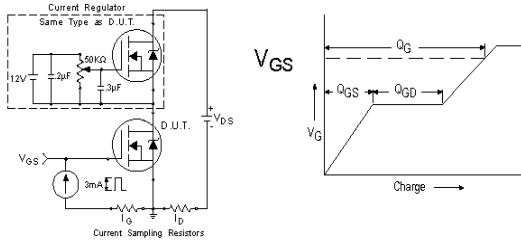

Fig 13a&b. Basic Gate Charge Test Circuit and Waveform

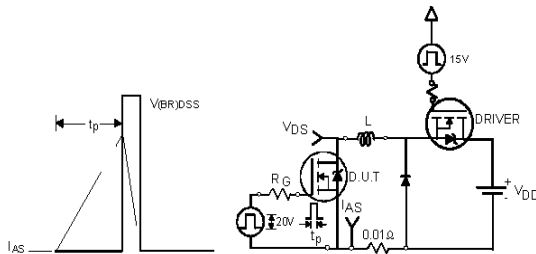

Fig 14a&b. Unclamped Inductive Test circuit and Waveforms

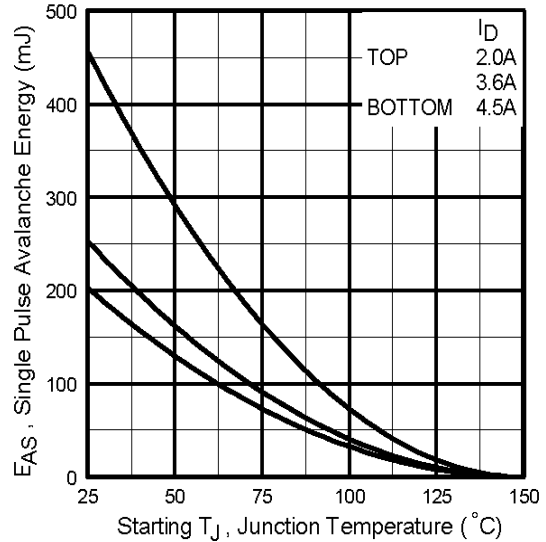
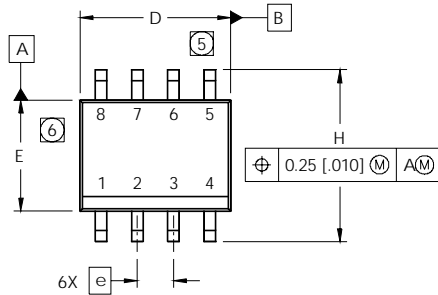

Fig 14c. Maximum Avalanche Energy Vs. Drain Current

SO-8 Package Outline

Dimensions are shown in millimeters (inches)



DIM	INCHES		MILLIMETERS	
	MIN	MAX	MIN	MAX
A	.0532	.0688	1.35	1.75
A1	.0040	.0098	0.10	0.25
b	.013	.020	0.33	0.51
c	.0075	.0098	0.19	0.25
D	.189	.1968	4.80	5.00
E	.1497	.1574	3.80	4.00
e	.050 BASIC		1.27 BASIC	
e1	.025 BASIC		0.635 BASIC	
H	.2284	.2440	5.80	6.20
K	.0099	.0196	0.25	0.50
L	.016	.050	0.40	1.27
y	0°	8°	0°	8°

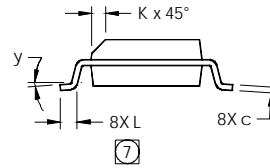
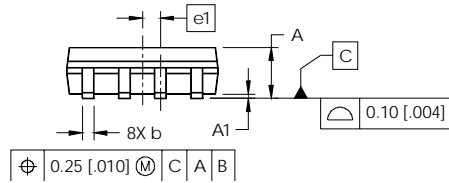

NOTES:

1. DIMENSIONING & TOLERANCING PER ASME Y14.5M-1994.
2. CONTROLLING DIMENSION: MILLIMETER
3. DIMENSIONS ARE SHOWN IN MILLIMETERS [INCHES].
4. OUTLINE CONFORMS TO JEDEC OUTLINE MS-012AA
- ⑤ DIMENSION DOES NOT INCLUDE MOLD PROTRUSIONS. MOLD PROTRUSIONS NOT TO EXCEED 0.15 [0.006].
- ⑥ DIMENSION DOES NOT INCLUDE MOLD PROTRUSIONS. MOLD PROTRUSIONS NOT TO EXCEED 0.25 [0.010].
- ⑦ DIMENSION IS THE LENGTH OF LEAD FOR SOLDERING TO A SUBSTRATE.

FOOTPRINT

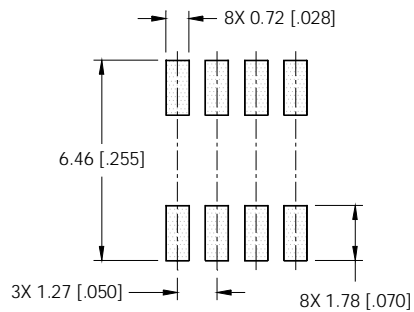

SO-8 Part Marking

EXAMPLE: THIS IS AN IRF7101 (MOSFET)

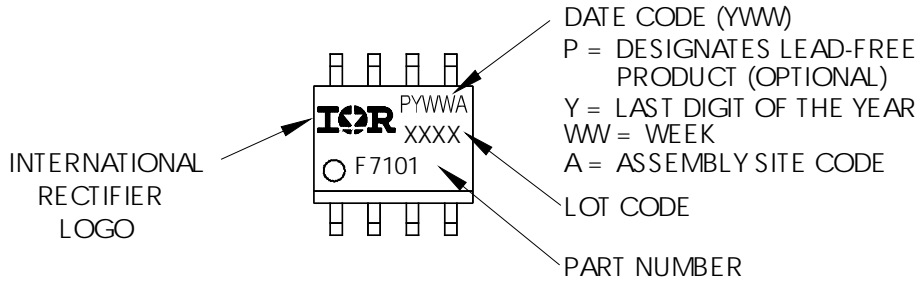

IRF7452PbF

International
IR Rectifier

SO-8 Tape and Reel

Dimensions are shown in millimeters (inches)

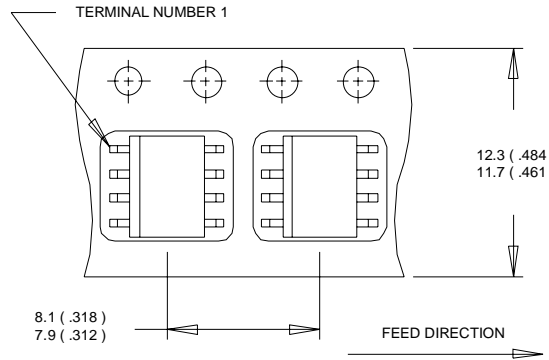

NOTES:

1. CONTROLLING DIMENSION : MILLIMETER.
2. ALL DIMENSIONS ARE SHOWN IN MILLIMETERS(INCHES).
3. OUTLINE CONFORMS TO EIA-481 & EIA-541.

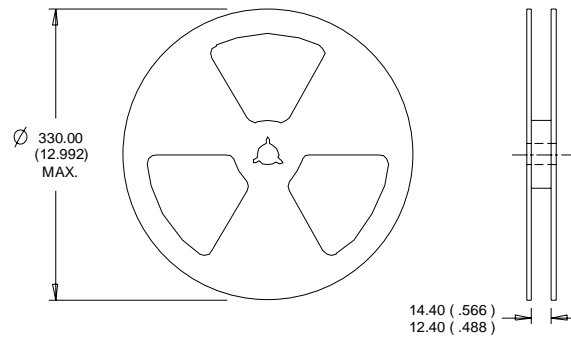

NOTES :

1. CONTROLLING DIMENSION : MILLIMETER.
2. OUTLINE CONFORMS TO EIA-481 & EIA-541.

Data and specifications subject to change without notice.
This product has been designed and qualified for the Consumer market.
Qualifications Standards can be found on IR's Web site.

International
IR Rectifier

IR WORLD HEADQUARTERS: 233 Kansas St., El Segundo, California 90245, USA Tel: (310) 252-7105
TAC Fax: (310) 252-7903

Visit us at www.irf.com for sales contact information.08/04

www.irf.com

Looking for pricing, stock, or lifecycle information?

Click below to explore more details on WIN SOURCE:

 [View IRF7452PBF on WIN SOURCE](#)

 [Infineon Technologies](#) Information

Optimize Your Supply Chain with WIN SOURCE Solutions

-  Global Sourcing Solution
-  Obsolete Management
-  Cost Control Management
-  Shortage Management
-  Alternative Solution
-  Excess Inventory Management