



**THE DATASHEET OF
IRF7534D1TR**



IRF7534D1

FETKY MOSFET & Schottky Diode

- Co-packaged HEXFET[®] power MOSFET and Schottky diode
- Ultra Low On-Resistance MOSFET
- Trench technology
- Micro8[™] Footprint
- Available in Tape & Reel

Description

The FETKY family of co-packaged MOSFETs and Schottky diodes offers the designer an innovative, board space saving solution for switching regulator and power management applications. International Rectifier utilizes advanced processing techniques to achieve extremely low on-resistance per silicon area. Combining this technology with International Rectifier's low forward drop Schottky rectifiers results in an extremely efficient device suitable for use in a wide variety of portable electronics applications, such as cell phones, PDAs, etc.

The Micro8[™] package makes an ideal device for applications where printed circuit board space is at a premium. The low profile (<1.1mm) of the Micro8[™] will allow it to fit easily into extremely thin application environments such as portable electronics

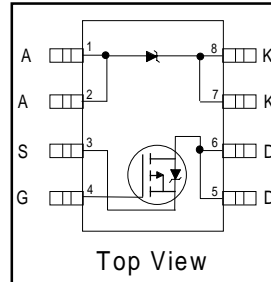

$V_{DSS} = -20V$
$R_{DS(on)} = 0.055\Omega$
Schottky Vf=0.39V

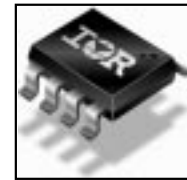

Micro8[™]

Absolute Maximum Ratings

	Parameter	Max.	Units
V_{DS}	Drain-Source Voltage	-20	V
$I_D @ T_A = 25^\circ C$	Continuous Drain Current, $V_{GS} @ -4.5V$	-4.3	A
$I_D @ T_A = 70^\circ C$	Continuous Drain Current, $V_{GS} @ -4.5V$	-3.4	
I_{DM}	Pulsed Drain Current ^①	-34	
$P_D @ T_A = 25^\circ C$	Maximum Power Dissipation ^④	1.25	W
$P_D @ T_A = 70^\circ C$	Maximum Power Dissipation ^④	0.8	W
	Linear Derating Factor	10	mW/°C
V_{GS}	Gate-to-Source Voltage	± 12	V
dv/dt	Peak Diode Recovery dv/dt ^②	1.1	V/ns
T_J, T_{STG}	Junction and Storage Temperature Range	-55 to + 150	°C

Thermal Resistance

	Parameter	Max.	Units
$R_{\theta JA}$	Maximum Junction-to-Ambient ^④	100	°C/W

Notes:

- ① Repetitive rating – pulse width limited by max. junction temperature (see Fig. 9)
- ② $I_{SD} \leq -1.2A$, $di/dt \leq 100A/\mu s$, $V_{DD} \leq V_{(BR)DSS}$, $T_J \leq 150^\circ C$
- ③ Pulse width $\leq 300\mu s$ – duty cycle $\leq 2\%$
- ④ When mounted on 1 inch square copper board to approximate typical multi-layer PCB thermal resistance

MOSFET Electrical Characteristics @ $T_J = 25^\circ\text{C}$ (unless otherwise specified)

	Parameter	Min.	Typ.	Max.	Units	Conditions
$V_{(BR)DSS}$	Drain-to-Source Breakdown Voltage	-20	—	—	V	$V_{GS} = 0V, I_D = -250\mu A$
$R_{DS(on)}$	Static Drain-to-Source On-Resistance	—	—	0.055	Ω	$V_{GS} = -4.5V, I_D = -4.3A$ ③
		—	—	0.105		$V_{GS} = -2.5V, I_D = -3.4A$ ③
$V_{GS(th)}$	Gate Threshold Voltage	-0.6	—	-1.2	V	$V_{DS} = V_{GS}, I_D = -250\mu A$
g_{fs}	Forward Transconductance	2.5	—	—	S	$V_{DS} = -10V, I_D = -0.8A$
I_{DSS}	Drain-to-Source Leakage Current	—	—	-1.0	μA	$V_{DS} = -16V, V_{GS} = 0V$
		—	—	-25		$V_{DS} = -16V, V_{GS} = 0V, T_J = 125^\circ\text{C}$
I_{GSS}	Gate-to-Source Forward Leakage	—	—	-100	nA	$V_{GS} = -12V$
	Gate-to-Source Reverse Leakage	—	—	100		$V_{GS} = 12V$
Q_g	Total Gate Charge	—	10	15	nC	$I_D = -3A$
Q_{gs}	Gate-to-Source Charge	—	2.1	3.1		$V_{DS} = -10V$
Q_{gd}	Gate-to-Drain ("Miller") Charge	—	2.5	3.7		$V_{GS} = -5V$
$t_{d(on)}$	Turn-On Delay Time	—	10	—	ns	$V_{DD} = -10V$
t_r	Rise Time	—	46	—		$I_D = -2A$
$t_{d(off)}$	Turn-Off Delay Time	—	60	—		$R_G = 6.0\Omega$
t_f	Fall Time	—	64	—		$R_D = 5\Omega, \text{③}$
C_{iss}	Input Capacitance	—	1066	—	pF	$V_{GS} = 0V$
C_{oss}	Output Capacitance	—	402	—		$V_{DS} = -10V$
C_{rss}	Reverse Transfer Capacitance	—	125	—		$f = 1.0\text{MHz}$

MOSFET Source-Drain Ratings and Characteristics

	Parameter	Min.	Typ.	Max.	Units	Conditions
I_S	Continuous Source Current (Body Diode)	—	—	-1.3	A	
I_{SM}	Pulsed Source Current (Body Diode)	—	—	-34		
V_{SD}	Body Diode Forward Voltage	—	—	-1.2	V	$T_J = 25^\circ\text{C}, I_S = -1.6A, V_{GS} = 0V$
t_{rr}	Reverse Recovery Time (Body Diode)	—	54	82	ns	$T_J = 25^\circ\text{C}, I_F = -2.5A$
Q_{rr}	Reverse Recovery Charge	—	41	61	nC	$di/dt = 100A/\mu s$ ③

Schottky Diode Maximum Ratings

	Parameter	Max.	Units	Conditions	
$I_{F(av)}$	Max. Average Forward Current	1.9	A	50% Duty Cycle. Rectangular Wave, $T_A = 25^\circ\text{C}$	
		1.4		See Fig.13 $T_A = 70^\circ\text{C}$	
I_{SM}	Max. peak one cycle Non-repetitive Surge current	120	A	5 μs sine or 3 μs Rect. pulse	Following any rated load condition & with V_{RRM} applied
		11		10ms sine or 6ms Rect. pulse	

Schottky Diode Electrical Specifications

	Parameter	Max.	Units	Conditions	
V_{FM}	Max. Forward voltage drop	0.50	V	$I_F = 1.0A, T_J = 25^\circ\text{C}$	
		0.62		$I_F = 2.0A, T_J = 25^\circ\text{C}$	
		0.39		$I_F = 1.0A, T_J = 125^\circ\text{C}$	
		0.57		$I_F = 2.0A, T_J = 125^\circ\text{C}$	
I_{RM}	Max. Reverse Leakage current	0.02	mA	$V_R = 20V$	$T_J = 25^\circ\text{C}$
		8			$T_J = 125^\circ\text{C}$
C_t	Max. Junction Capacitance	92	pF	$V_R = 5V_{dc}$ (100kHz to 1 MHz) 25°C	
dv/dt	Max. Voltage Rate of Charge	3600	V/ μs	Rated V_R	

(HEXFET is the reg. TM for International Rectifier Power MOSFET's)

Power MOSFET Characteristics

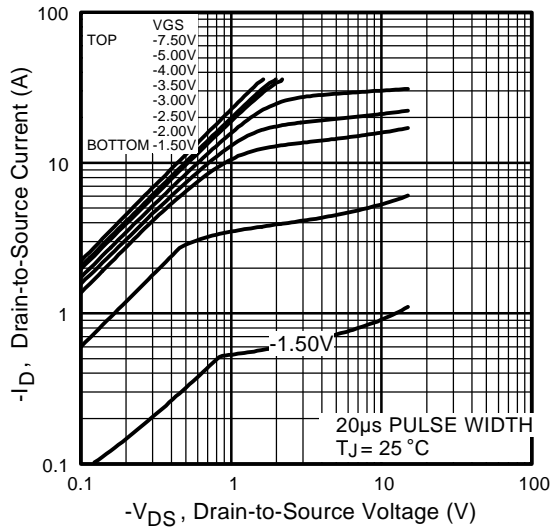

Fig 1. Typical Output Characteristics

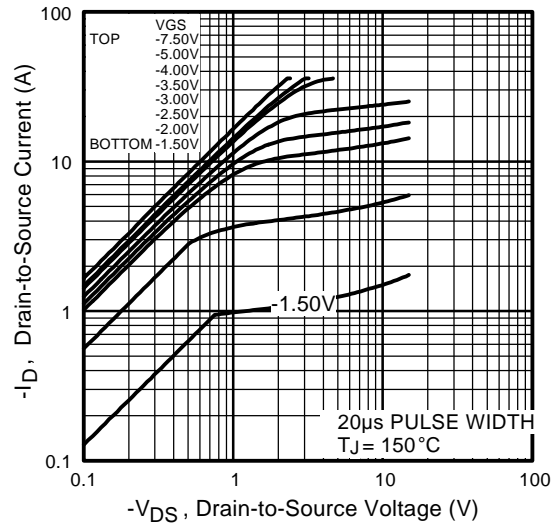

Fig 2. Typical Output Characteristics

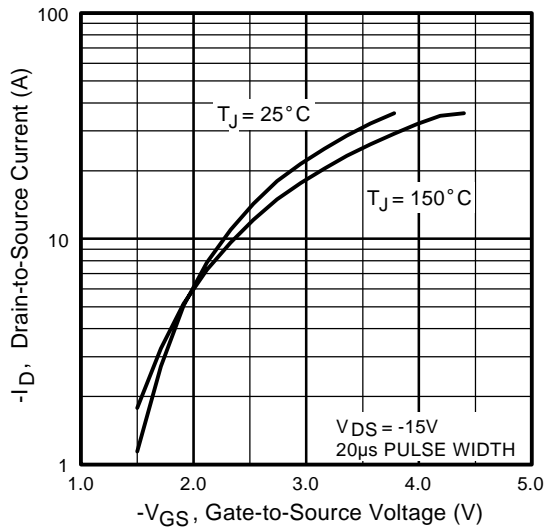

Fig 3. Typical Transfer Characteristics

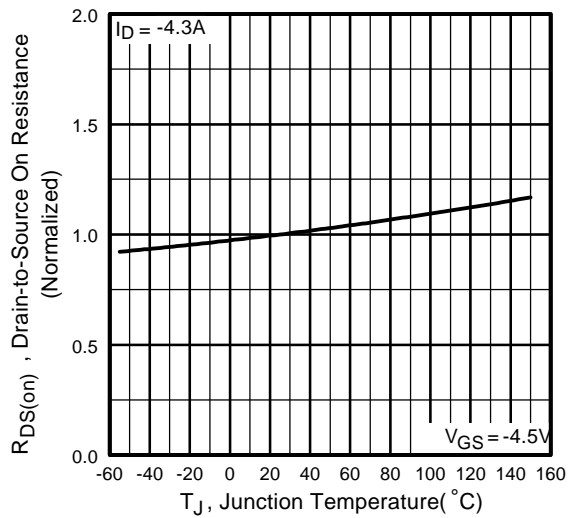

Fig 4. Normalized On-Resistance Vs. Temperature

Power MOSFET Characteristics

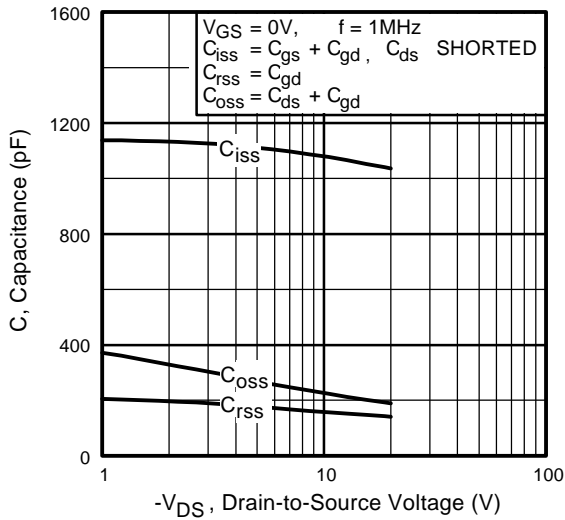

Fig 5. Typical Capacitance Vs. Drain-to-Source Voltage

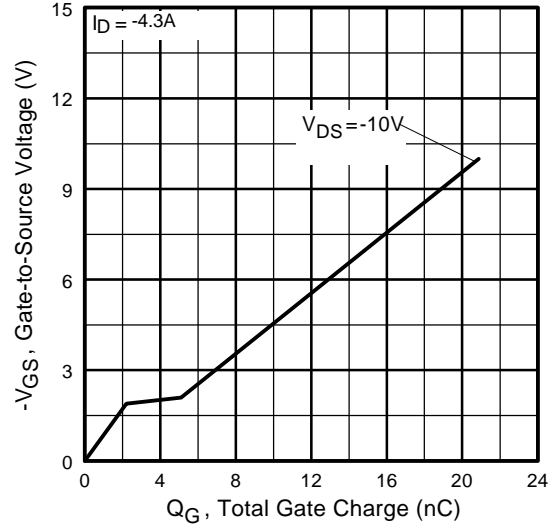

Fig 6. Typical Gate Charge Vs. Gate-to-Source Voltage

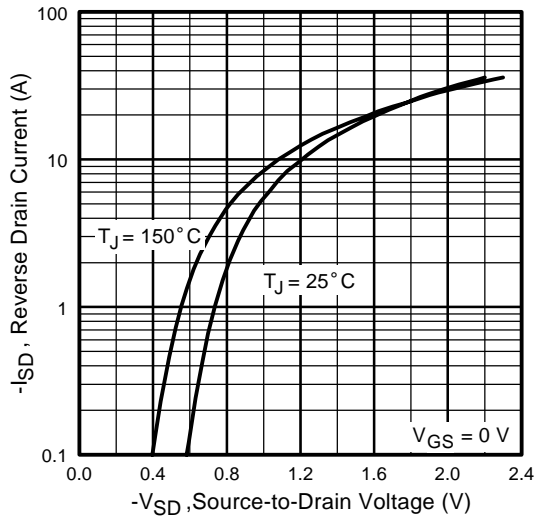

Fig 7. Typical Source-Drain Diode Forward Voltage

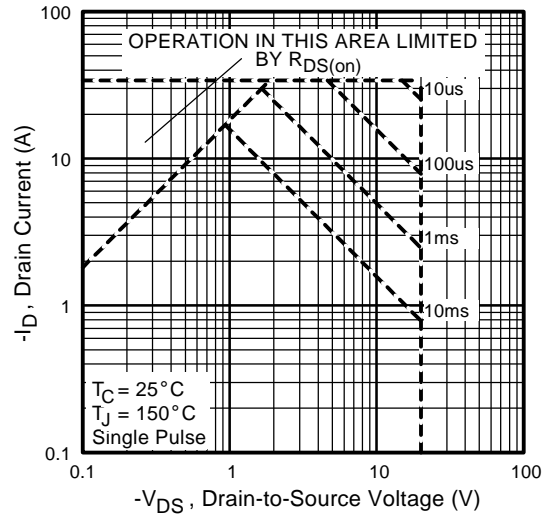

Fig 8. Maximum Safe Operating Area

Power MOSFET Characteristics

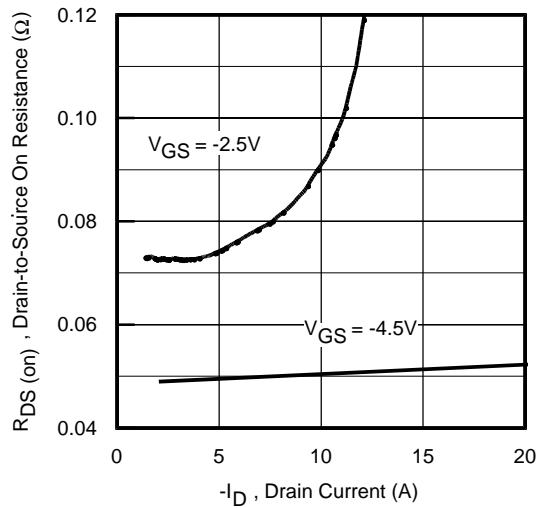

Fig 9. Typical On-Resistance Vs. Drain Current

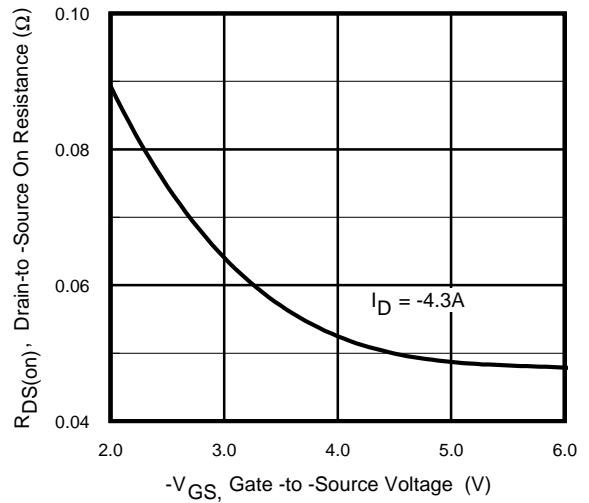

Fig 10. Typical On-Resistance Vs. Gate Voltage

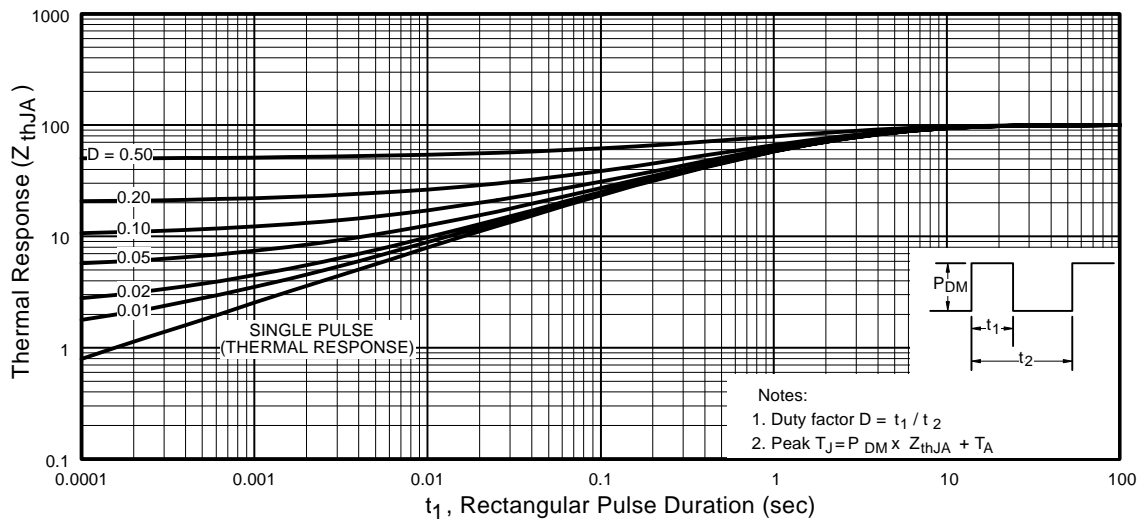

Fig 11. Maximum Effective Transient Thermal Impedance, Junction-to-Ambient

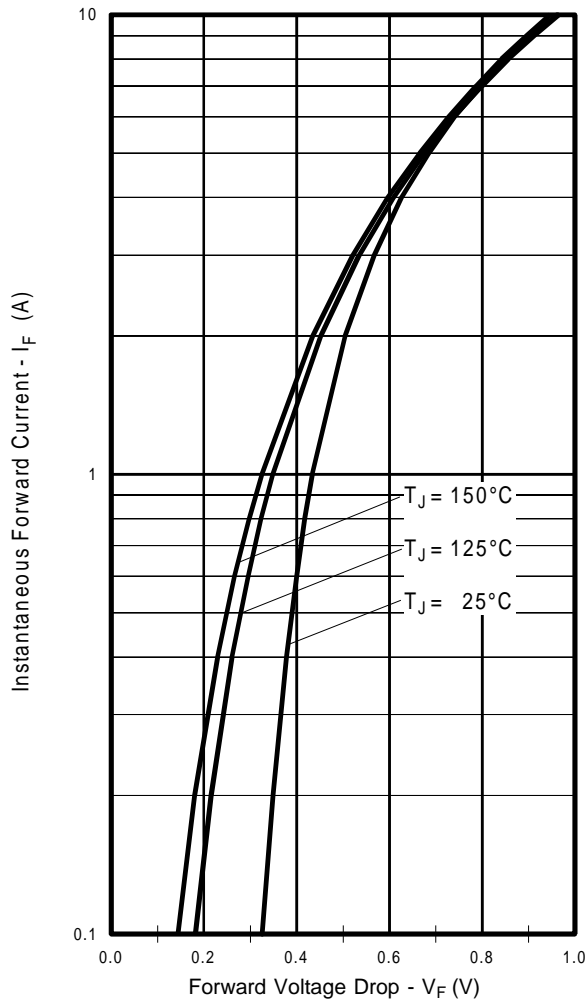

Fig. 12 -Typical Forward Voltage Drop Characteristics

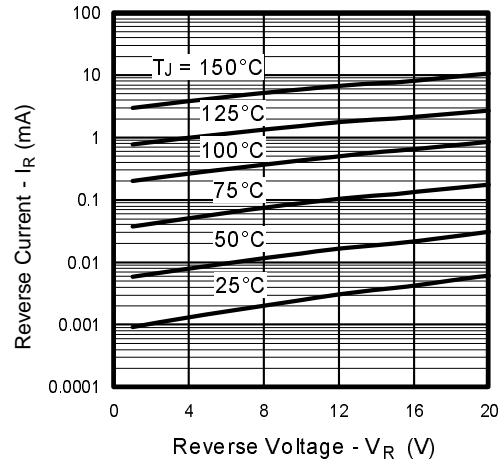

Fig. 13 - Typical Values of Reverse Current Vs. Reverse Voltage

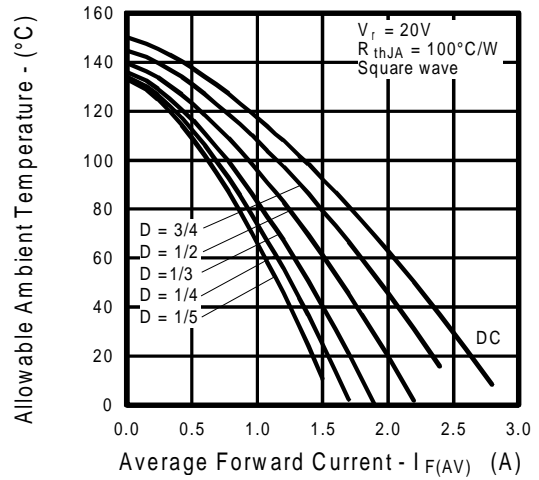
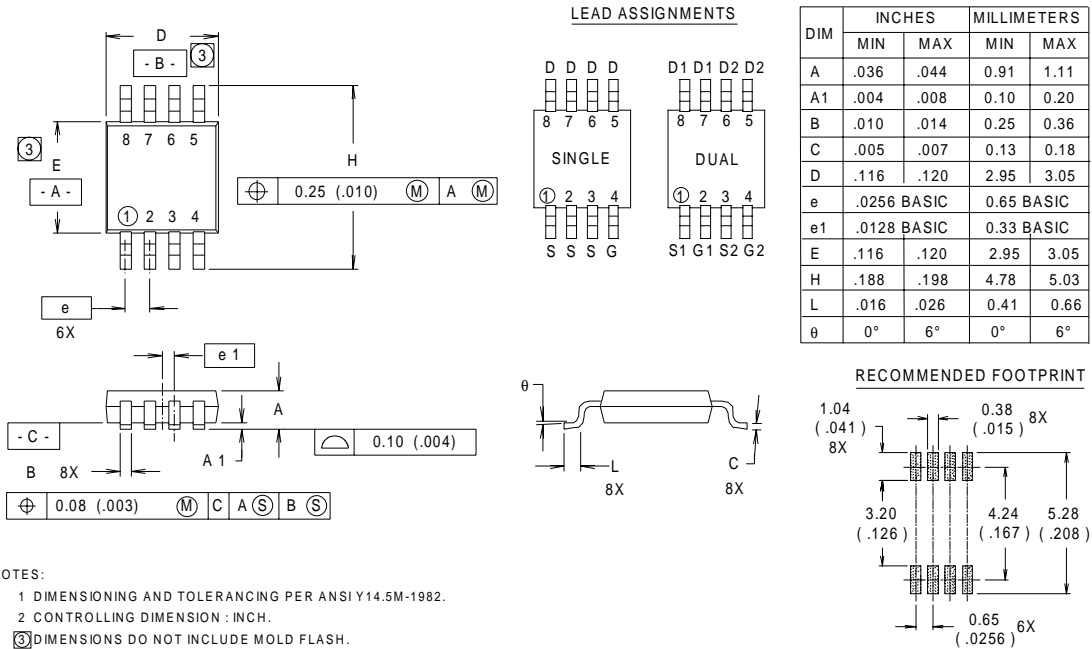

Fig.14 - Maximum Allowable Ambient Temp. Vs. Forward Current

Package Outline

Micro8™ Outline

Dimensions are shown in millimeters (inches)



Part Marking Information

Micro8™

EXAMPLE : THIS IS AN IRF7501

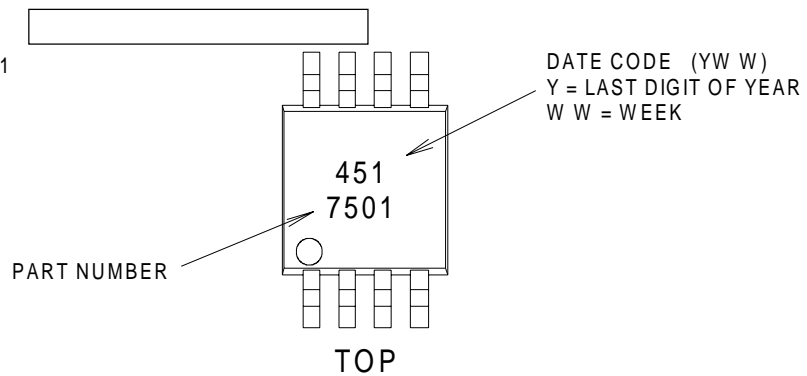

IRF7534D1

International
IR Rectifier

Tape & Reel Information

Micro8™

Dimensions are shown in millimeters (inches)

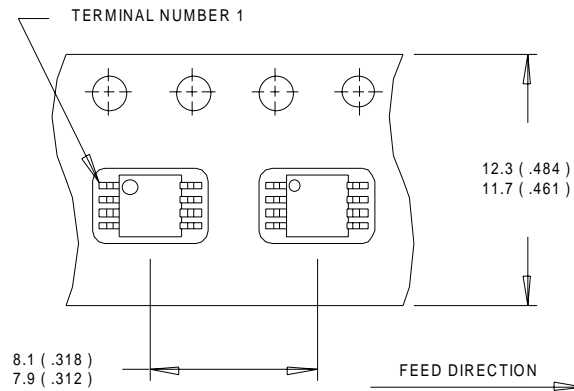

NOTES:

1. OUTLINE CONFORMS TO EIA-481 & EIA-541.
2. CONTROLLING DIMENSION : MILLIMETER.

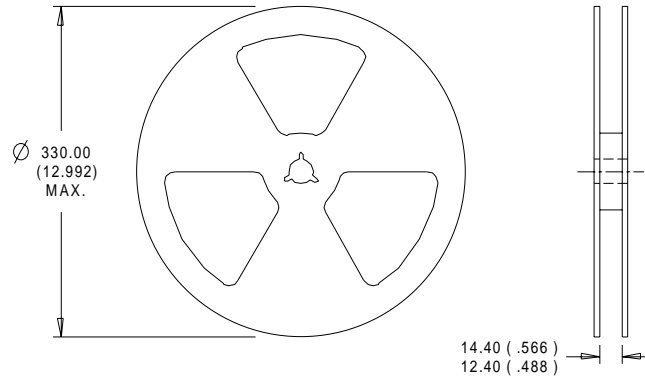

NOTES:

1. CONTROLLING DIMENSION : MILLIMETER.
2. OUTLINE CONFORMS TO EIA-481 & EIA-541.

International
IR Rectifier

WORLD HEADQUARTERS: 233 Kansas St., El Segundo, California 90245, Tel: (310) 252 7105

IR GREAT BRITAIN: Hurst Green, Oxted, Surrey RH8 9BB, UK Tel: ++ 44 1883 732020

IR CANADA: 15 Lincoln Court, Brampton, Ontario L6T3Z2, Tel: (905) 453 2200

IR GERMANY: Saalburgstrasse 157, 61350 Bad Homburg Tel: ++ 49 6172 96590

IR ITALY: Via Liguria 49, 10071 Borgaro, Torino Tel: ++ 39 11 451 0111

IR JAPAN: K&H Bldg., 2F, 30-4 Nishi-Ikebukuro 3-Chome, Toshima-Ku, Tokyo Japan 171 Tel: 81 3 3983 0086

IR SOUTHEAST ASIA: 1 Kim Seng Promenade, Great World City West Tower, 13-11, Singapore 237994 Tel: ++ 65 838 4630

IR TAIWAN: 16 Fl. Suite D. 207, Sec. 2, Tun Haw South Road, Taipei, 10673, Taiwan Tel: 886-2-2377-9936

Data and specifications subject to change without notice. 2/2000

Looking for pricing, stock, or lifecycle information?

Click below to explore more details on WIN SOURCE:

 [View IRF7534D1TR on WIN SOURCE](#)

 [Infineon Technologies](#) Information

Optimize Your Supply Chain with WIN SOURCE Solutions

-  Global Sourcing Solution
-  Obsolete Management
-  Cost Control Management
-  Shortage Management
-  Alternative Solution
-  Excess Inventory Management