



**THE DATASHEET OF  
IRF7811AVPBF**



# IRF7811AVPbF

- N-Channel Application-Specific MOSFETs
- Ideal for CPU Core DC-DC Converters
- Low Conduction Losses
- Low Switching Losses
- Minimizes Parallel MOSFETs for high current applications
- 100% R<sub>G</sub> Tested
- Lead-Free

## Description

This new device employs advanced HEXFET Power MOSFET technology to achieve an unprecedented balance of on-resistance and gate charge. The reduced conduction and switching losses make it ideal for high efficiency DC-DC converters that power the latest generation of microprocessors.

The IRF7811AV has been optimized for all parameters that are critical in synchronous buck converters including R<sub>DS(on)</sub>, gate charge and C<sub>dv/dt</sub>-induced turn-on immunity. The IRF7811AV offers an extremely low combination of Q<sub>sw</sub> & R<sub>DS(on)</sub> for reduced losses in both control and synchronous FET applications.

The package is designed for vapor phase, infra-red, convection, or wave soldering techniques. Power dissipation of greater than 2W is possible in a typical PCB mount application.

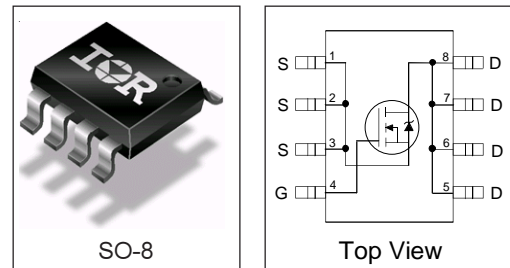

## DEVICE CHARACTERISTICS<sup>⑤</sup>

	IRF7811AV
R <sub>DS(on)</sub>	11 mΩ
Q <sub>G</sub>	17 nC
Q <sub>sw</sub>	6.7 nC
Q <sub>oss</sub>	8.1 nC

## Absolute Maximum Ratings

Parameter	Symbol	IRF7811AV	Units
Drain-to-Source Voltage	V <sub>DS</sub>	30	V
Gate-to-Source Voltage	V <sub>GS</sub>	±20	
Continuous Output Current (V <sub>GS</sub> ≥ 4.5V)	T <sub>A</sub> = 25°C	10.8	A
	T <sub>L</sub> = 90°C	11.8	
Pulsed Drain Current <sup>①</sup>	I <sub>DM</sub>	100	
Power Dissipation <sup>③</sup>	T <sub>A</sub> = 25°C	2.5	W
	T <sub>L</sub> = 90°C	3.0	
Junction & Storage Temperature Range	T <sub>J</sub> , T <sub>STG</sub>	-55 to 150	°C
Continuous Source Current (Body Diode)	I <sub>S</sub>	2.5	A
Pulsed Source Current <sup>①</sup>	I <sub>SM</sub>	50	

## Thermal Resistance

Parameter	Symbol	Typ	Max	Units
Maximum Junction-to-Ambient <sup>②⑥</sup>	R <sub>θJA</sub>	—	50	°C/W
Maximum Junction-to-Lead <sup>⑥</sup>	R <sub>θJL</sub>	—	20	

## Electrical Characteristics

Parameter	Symbol	Min	Typ	Max	Units	Conditions
Drain-to-Source Breakdown Voltage	$V_{(BR)DSS}$	30	—	—	V	$V_{GS} = 0V, I_D = 250\mu A$
Static Drain-to-Source On-Resistance	$R_{DS(on)}$	—	11	14	m $\Omega$	$V_{GS} = 4.5V, I_D = 15A$ ②
Gate Threshold Voltage	$V_{GS(th)}$	1.0	—	3.0	V	$V_{DS} = V_{GS}, I_D = 250\mu A$
Drain-to-Source Leakage Current	$I_{DSS}$	—	—	50	$\mu A$	$V_{DS} = 30V, V_{GS} = 0V$
		—	—	20	$\mu A$	$V_{DS} = 24V, V_{GS} = 0V$
		—	—	100	mA	$V_{DS} = 24V, V_{GS} = 0V, T_J = 100^\circ C$
Gate-to-Source Leakage Current	$I_{GSS}$	—	—	$\pm 100$	nA	$V_{GS} = \pm 20V$
Total Gate Charge, Control FET	$Q_g$	—	17	26	nC	$V_{DS} = 24V, I_D = 15A, V_{GS} = 5.0V$
Total Gate Charge, Synch FET	$Q_g$	—	14	21	nC	$V_{GS} = 5.0V, V_{DS} < 100mV$
Pre-V <sub>th</sub> Gate-to-Source Charge	$Q_{gs1}$	—	3.4	—	nC	$V_{DS} = 16V, I_D = 15A$
Post-V <sub>th</sub> Gate-to-Source Charge	$Q_{gs2}$	—	1.6	—	nC	
Gate-to-Drain ("Miller") Charge	$Q_{gd}$	—	5.1	—	nC	
Switch Charge ( $Q_{gs2} + Q_{gd}$ )	$Q_{SW}$	—	6.7	—	nC	
Output Charge	$Q_{OSS}$	—	8.1	12	nC	
Gate Resistance	$R_G$	0.5	—	4.4	$\Omega$	$V_{DS} = 16V, V_{GS} = 0$
Turn-On Delay Time	$t_{d(on)}$	—	8.6	—	ns	$V_{DD} = 16V$ $I_D = 15A$ $V_{GS} = 5.0V$ Clamped Inductive Load
Rise Time	$t_r$	—	21	—	ns	
Turn-Off Delay Time	$t_{d(off)}$	—	43	—	ns	
Fall Time	$t_f$	—	10	—	ns	
Input Capacitance	$C_{iss}$	—	1801	—	pF	$V_{GS} = 0V$
Output Capacitance	$C_{oss}$	—	723	—	pF	$V_{DS} = 10V$
Reverse Transfer Capacitance	$C_{rss}$	—	46	—	pF	

## Diode Characteristics

Parameter	Symbol	Min	Typ	Max	Units	Conditions
Diode Forward Voltage	$V_{SD}$	—	—	1.3	V	$T_J = 25^\circ C, I_S = 15A$ ②, $V_{GS} = 0V$
Reverse Recovery Charge ④	$Q_{rr}$	—	50	—	nC	$di/dt = 700A/\mu s$ $V_{DD} = 16V, V_{GS} = 0V, I_D = 15A$
Reverse Recovery Charge (with Parallel Schottsky) ④	$Q_{rr}$	—	43	—	nC	$di/dt = 700A/\mu s$ , (with 10BQ040) $V_{DD} = 16V, V_{GS} = 0V, I_D = 15A$

### Notes:

- ① Repetitive rating; pulse width limited by max. junction temperature.
- ② Pulse width  $\leq 400 \mu s$ ; duty cycle  $\leq 2\%$ .
- ③ When mounted on 1 inch square copper board,  $t < 10$  sec.
- ④ Typ = measured -  $Q_{oss}$
- ⑤ Typical values of  $R_{DS(on)}$  measured at  $V_{GS} = 4.5V$ ,  $Q_g$ ,  $Q_{SW}$  and  $Q_{OSS}$  measured at  $V_{GS} = 5.0V$ ,  $I_F = 15A$ .
- ⑥  $R_{\theta}$  is measured at  $T_J$  approximately  $90^\circ C$

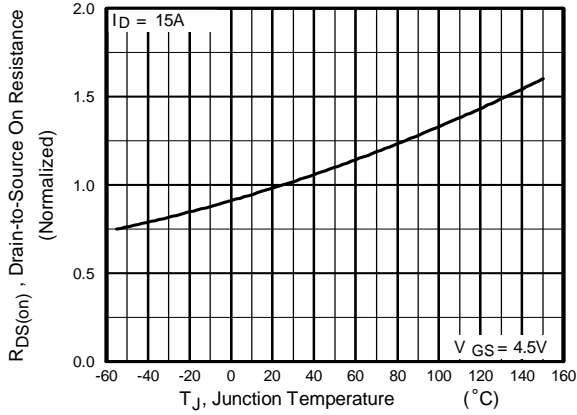

Figure 1. Normalized On-Resistance vs. Temperature

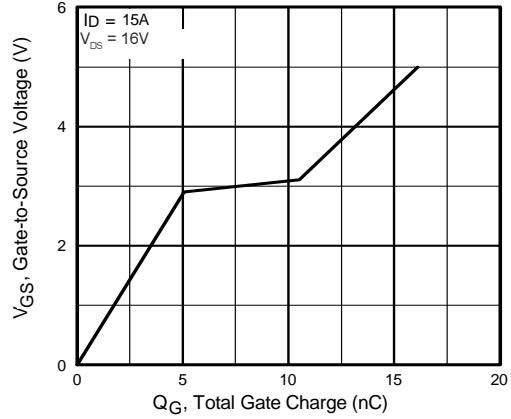

Figure 2. Gate-to-Source Voltage vs. Typical Gate Charge

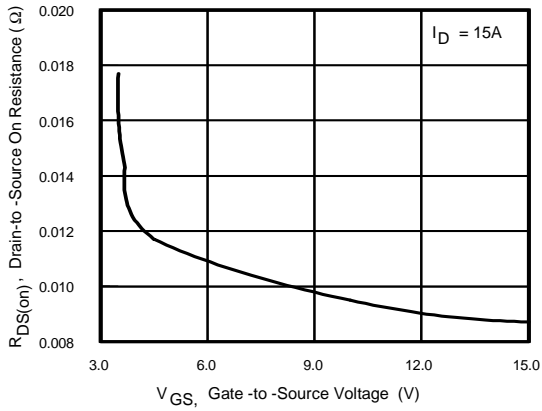

Figure 3. Typical  $R_{DS(on)}$  vs. Gate-to-Source Voltage

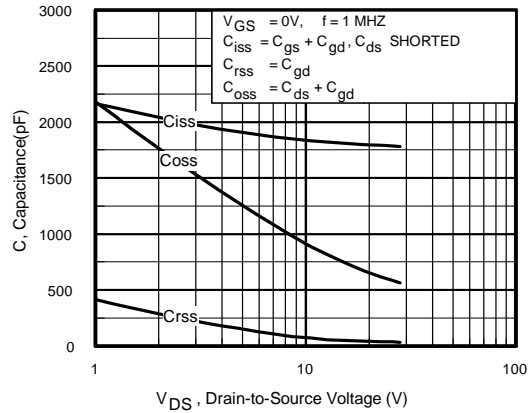

Figure 4. Typical Capacitance vs. Drain-to-Source Voltage

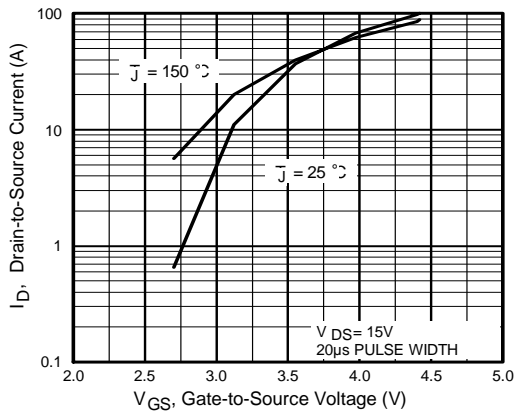

Figure 5. Typical Transfer Characteristics

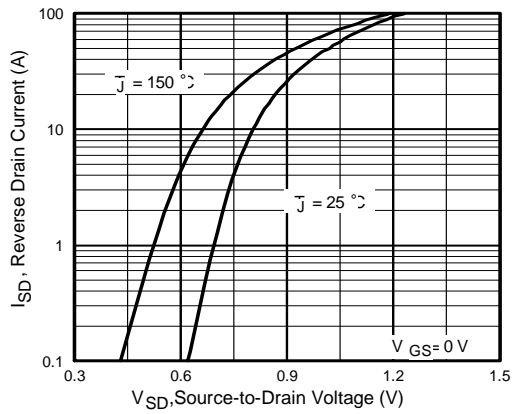

Figure 6. Typical Source-Drain Diode Forward Voltage

# IRF7811AVPbF

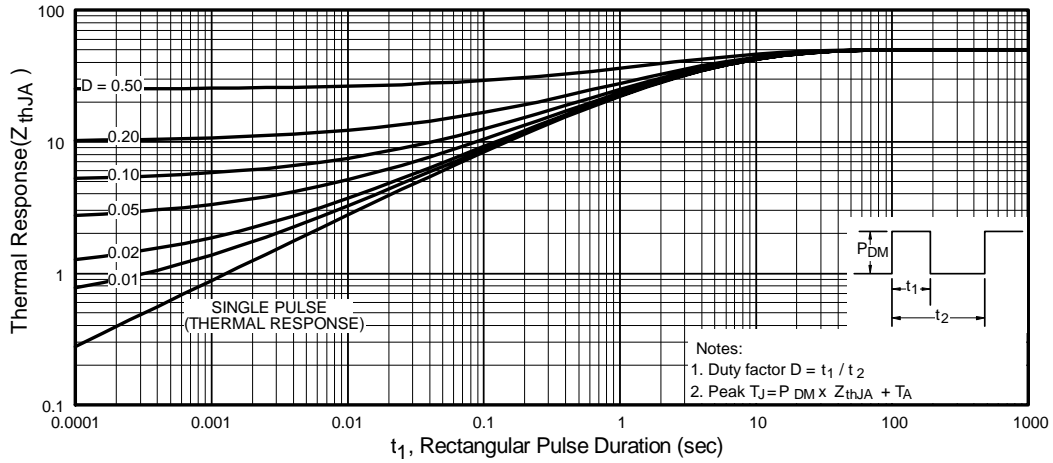

Figure 7. Maximum Effective Transient Thermal Impedance, Junction-to-Ambient

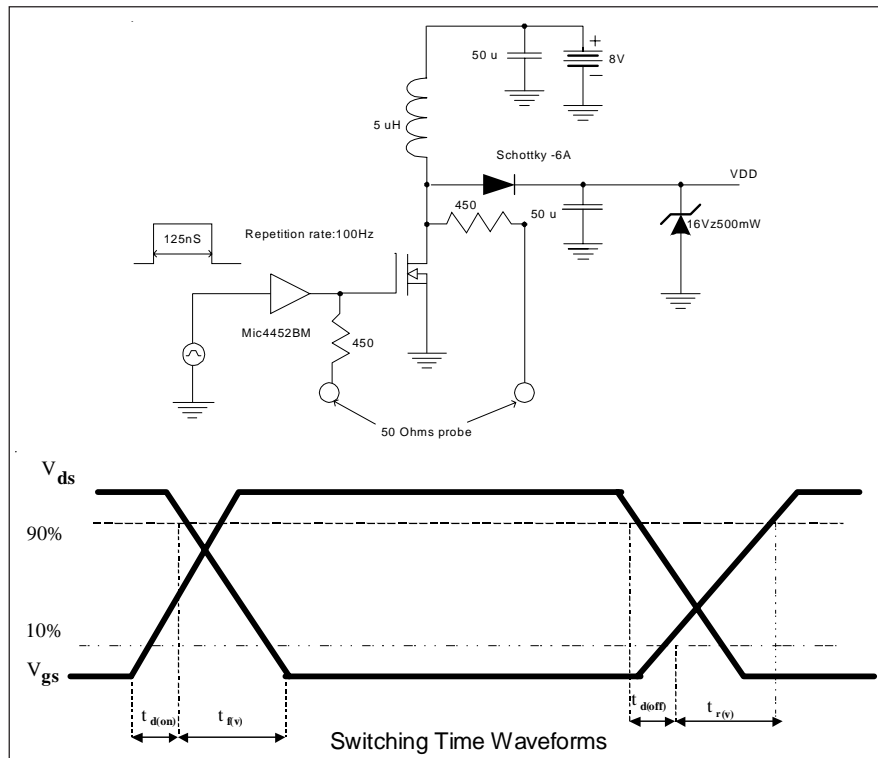
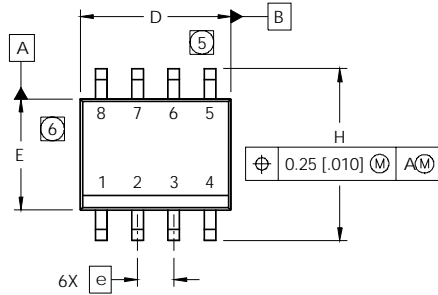

Figure 8. Clamped Inductive load test diagram and switching waveform

## SO-8 Package Outline

Dimensions are shown in millimeters (inches)



DIM	INCHES		MILLIMETERS	
	MIN	MAX	MIN	MAX
A	.0532	.0688	1.35	1.75
A1	.0040	.0098	0.10	0.25
b	.013	.020	0.33	0.51
c	.0075	.0098	0.19	0.25
D	.189	.1968	4.80	5.00
E	.1497	.1574	3.80	4.00
e	.050 BASIC		1.27 BASIC	
e1	.025 BASIC		0.635 BASIC	
H	.2284	.2440	5.80	6.20
K	.0099	.0196	0.25	0.50
L	.016	.050	0.40	1.27
y	0°	8°	0°	8°

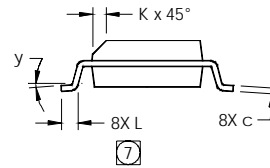
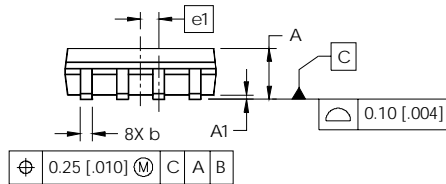

NOTES:

1. DIMENSIONING & TOLERANCING PER ASME Y14.5M-1994.
2. CONTROLLING DIMENSION: MILLIMETER
3. DIMENSIONS ARE SHOWN IN MILLIMETERS [INCHES].
4. OUTLINE CONFORMS TO JEDEC OUTLINE MS-012AA.
5. DIMENSION DOES NOT INCLUDE MOLD PROTRUSIONS. MOLD PROTRUSIONS NOT TO EXCEED 0.15 [0.006].
6. DIMENSION DOES NOT INCLUDE MOLD PROTRUSIONS. MOLD PROTRUSIONS NOT TO EXCEED 0.25 [0.010].
7. DIMENSION IS THE LENGTH OF LEAD FOR SOLDERING TO A SUBSTRATE.

FOOTPRINT

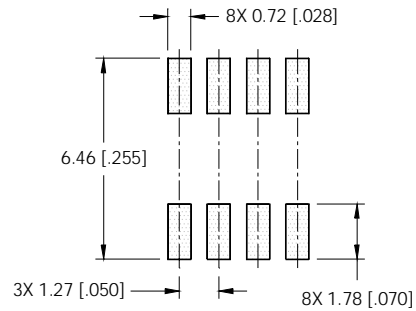

## SO-8 Part Marking

EXAMPLE: THIS IS AN IRF7101 (MOSFET)

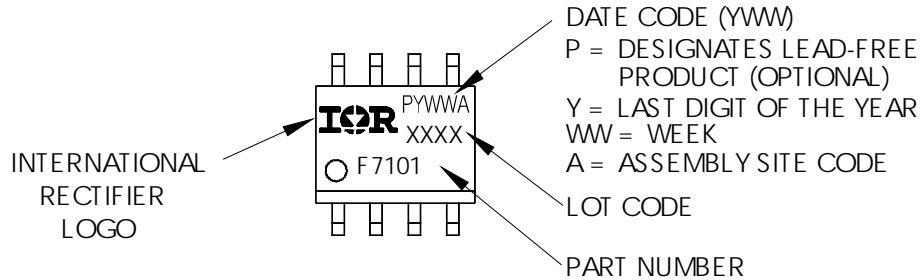

# IRF7811AVPbF

International  
**IR** Rectifier

## SO-8 Tape and Reel

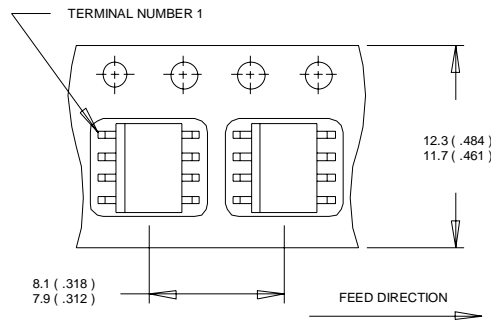

- NOTES:
1. CONTROLLING DIMENSION : MILLIMETER.
  2. ALL DIMENSIONS ARE SHOWN IN MILLIMETERS(INCHES).
  3. OUTLINE CONFORMS TO EIA-481 & EIA-541.

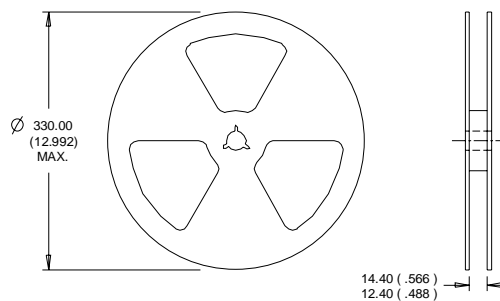

- NOTES :
1. CONTROLLING DIMENSION : MILLIMETER.
  2. OUTLINE CONFORMS TO EIA-481 & EIA-541.

Data and specifications subject to change without notice.  
This product has been designed and qualified for the Consumer market.  
Qualifications Standards can be found on IR's Web site.

International  
**IR** Rectifier

**IR WORLD HEADQUARTERS:** 233 Kansas St., El Segundo, California 90245, USA Tel: (310) 252-7105  
TAC Fax: (310) 252-7903

Visit us at [www.irf.com](http://www.irf.com) for sales contact information.08/04

[www.irf.com](http://www.irf.com)

## **IMPORTANT NOTICE**

The information given in this document shall in no event be regarded as a guarantee of conditions or characteristics ("Beschaffheitsgarantie").

With respect to any examples, hints or any typical values stated herein and/or any information regarding the application of the product, Infineon Technologies hereby disclaims any and all warranties and liabilities of any kind, including without limitation warranties of non-infringement of intellectual property rights of any third party.

In addition, any information given in this document is subject to customer's compliance with its obligations stated in this document and any applicable legal requirements, norms and standards concerning customer's products and any use of the product of Infineon Technologies in customer's applications.

The data contained in this document is exclusively intended for technically trained staff. It is the responsibility of customer's technical departments to evaluate the suitability of the product for the intended application and the completeness of the product information given in this document with respect to such application.

For further information on the product, technology, delivery terms and conditions and prices please contact your nearest Infineon Technologies office ([www.infineon.com](http://www.infineon.com)).

## **WARNINGS**

Due to technical requirements products may contain dangerous substances. For information on the types in question please contact your nearest Infineon Technologies office.

Except as otherwise explicitly approved by Infineon Technologies in a written document signed by authorized representatives of Infineon Technologies, Infineon Technologies' products may not be used in any applications where a failure of the product or any consequences of the use thereof can reasonably be expected to result in personal injury.

## Looking for pricing, stock, or lifecycle information?

Click below to explore more details on WIN SOURCE:

 [View IRF7811AVPBF on WIN SOURCE](#)

 [Infineon Technologies](#) Information

## Optimize Your Supply Chain with WIN SOURCE Solutions

-  Global Sourcing Solution
-  Obsolete Management
-  Cost Control Management
-  Shortage Management
-  Alternative Solution
-  Excess Inventory Management