



THE DATASHEET OF IRF8910PBF



IRF8910PbF

HEXFET® Power MOSFET

Applications

- Dual SO-8 MOSFET for POL converters in desktop, servers, graphics cards, game consoles and set-top box
- Lead-Free

Benefits

- Very Low $R_{DS(on)}$ at 4.5V V_{GS}
- Ultra-Low Gate Impedance
- Fully Characterized Avalanche Voltage and Current
- 20V V_{GS} Max. Gate Rating

| V_{DSS} | $R_{DS(on)}$ max | I_D |
|-----------|---------------------------------|-------|
| 20V | 13.4m Ω @ $V_{GS} = 10V$ | 10A |

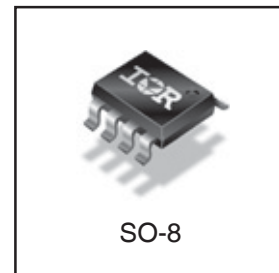
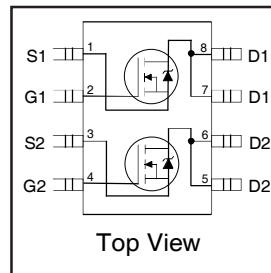

Absolute Maximum Ratings

| | Parameter | Max. | Units |
|--------------------------|------------------------------------------|--------------|---------------|
| V_{DS} | Drain-to-Source Voltage | 20 | V |
| V_{GS} | Gate-to-Source Voltage | ± 20 | |
| $I_D @ T_A = 25^\circ C$ | Continuous Drain Current, $V_{GS} @ 10V$ | 10 | A |
| $I_D @ T_A = 70^\circ C$ | Continuous Drain Current, $V_{GS} @ 10V$ | 8.3 | |
| I_{DM} | Pulsed Drain Current ① | 82 | |
| $P_D @ T_A = 25^\circ C$ | Power Dissipation | 2.0 | W |
| $P_D @ T_A = 70^\circ C$ | Power Dissipation | 1.3 | |
| | Linear Derating Factor | 0.016 | W/ $^\circ C$ |
| T_J | Operating Junction and | -55 to + 150 | $^\circ C$ |
| T_{STG} | Storage Temperature Range | | |

Thermal Resistance

| | Parameter | Typ. | Max. | Units |
|-----------------|------------------------|------|------|--------------|
| $R_{\theta JL}$ | Junction-to-Drain Lead | — | 42 | $^\circ C/W$ |
| $R_{\theta JA}$ | Junction-to-Ambient ④⑤ | — | 62.5 | |

Notes ① through ⑤ are on page 10

www.irf.com

Static @ $T_J = 25^\circ\text{C}$ (unless otherwise specified)

| | Parameter | Min. | Typ. | Max. | Units | Conditions |
|--------------------------------|--------------------------------------------|------|-------|------|---------------------|-------------------------------------------------------------------------|
| BV_{DSS} | Drain-to-Source Breakdown Voltage | 20 | — | — | V | $V_{GS} = 0V, I_D = 250\mu A$ |
| $\Delta BV_{DSS}/\Delta T_J$ | Breakdown Voltage Temp. Coefficient | — | 0.015 | — | $V/^\circ\text{C}$ | Reference to $25^\circ\text{C}, I_D = 1\text{mA}$ |
| $R_{DS(on)}$ | Static Drain-to-Source On-Resistance | — | 10.7 | 13.4 | $m\Omega$ | $V_{GS} = 10V, I_D = 10A$ ③ |
| | | — | 14.6 | 18.3 | | $V_{GS} = 4.5V, I_D = 8.0A$ ③ |
| $V_{GS(th)}$ | Gate Threshold Voltage | 1.65 | — | 2.55 | V | $V_{DS} = V_{GS}, I_D = 250\mu A$ |
| $\Delta V_{GS(th)}/\Delta T_J$ | Gate Threshold Voltage Coefficient | — | -4.8 | — | $mV/^\circ\text{C}$ | |
| I_{DSS} | Drain-to-Source Leakage Current | — | — | 1.0 | μA | $V_{DS} = 16V, V_{GS} = 0V$ |
| | | — | — | 150 | | $V_{DS} = 16V, V_{GS} = 0V, T_J = 125^\circ\text{C}$ |
| I_{GSS} | Gate-to-Source Forward Leakage | — | — | 100 | nA | $V_{GS} = 20V$ |
| | Gate-to-Source Reverse Leakage | — | — | -100 | | $V_{GS} = -20V$ |
| g_{fs} | Forward Transconductance | 24 | — | — | S | $V_{DS} = 10V, I_D = 8.2A$ |
| Q_g | Total Gate Charge | — | 7.4 | 11 | nC | $V_{DS} = 10V$ $V_{GS} = 4.5V$ $I_D = 8.2A$ See Fig. 6 |
| Q_{gs1} | Pre-V _{th} Gate-to-Source Charge | — | 2.4 | — | | |
| Q_{gs2} | Post-V _{th} Gate-to-Source Charge | — | 0.80 | — | | |
| Q_{gd} | Gate-to-Drain Charge | — | 2.5 | — | | |
| Q_{godr} | Gate Charge Overdrive | — | 1.7 | — | | |
| Q_{sw} | Switch Charge ($Q_{gs2} + Q_{gd}$) | — | 3.3 | — | | |
| Q_{oss} | Output Charge | — | 4.4 | — | nC | $V_{DS} = 10V, V_{GS} = 0V$ |
| $t_{d(on)}$ | Turn-On Delay Time | — | 6.2 | — | ns | $V_{DD} = 10V, V_{GS} = 4.5V$ $I_D = 8.2A$ Clamped Inductive Load |
| t_r | Rise Time | — | 10 | — | | |
| $t_{d(off)}$ | Turn-Off Delay Time | — | 9.7 | — | | |
| t_f | Fall Time | — | 4.1 | — | | |
| C_{iss} | Input Capacitance | — | 960 | — | pF | $V_{GS} = 0V$ |
| C_{oss} | Output Capacitance | — | 300 | — | | $V_{DS} = 10V$ |
| C_{rss} | Reverse Transfer Capacitance | — | 160 | — | | $f = 1.0\text{MHz}$ |

Avalanche Characteristics

| | Parameter | Typ. | Max. | Units |
|----------|---------------------------------|------|------|-------|
| E_{AS} | Single Pulse Avalanche Energy ② | — | 19 | mJ |
| I_{AR} | Avalanche Current ① | — | 8.2 | A |

Diode Characteristics

| | Parameter | Min. | Typ. | Max. | Units | Conditions |
|----------|-------------------------------------------|------|------|------|-------|-------------------------------------------------------------------------|
| I_S | Continuous Source Current (Body Diode) | — | — | 2.5 | A | MOSFET symbol showing the integral reverse p-n junction diode. |
| I_{SM} | Pulsed Source Current (Body Diode) ① | — | — | 82 | | |
| V_{SD} | Diode Forward Voltage | — | — | 1.0 | V | $T_J = 25^\circ\text{C}, I_S = 8.2A, V_{GS} = 0V$ ③ |
| t_{rr} | Reverse Recovery Time | — | 17 | 26 | ns | $T_J = 25^\circ\text{C}, I_F = 8.2A, V_{DD} = 10V$ |
| Q_{rr} | Reverse Recovery Charge | — | 6.5 | 9.7 | nC | $di/dt = 100A/\mu s$ ③ |

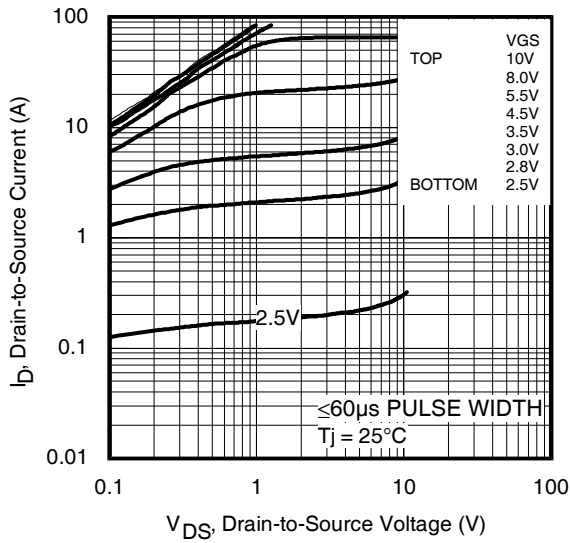

Fig 1. Typical Output Characteristics

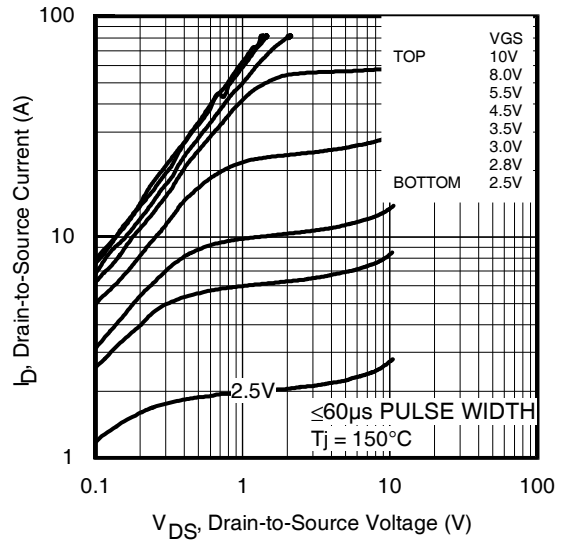

Fig 2. Typical Output Characteristics

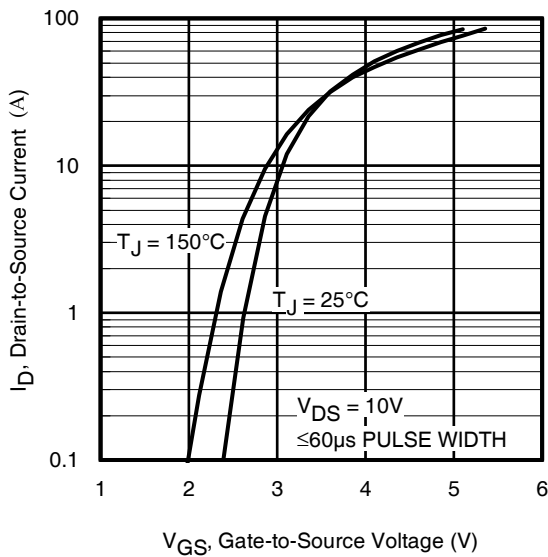

Fig 3. Typical Transfer Characteristics

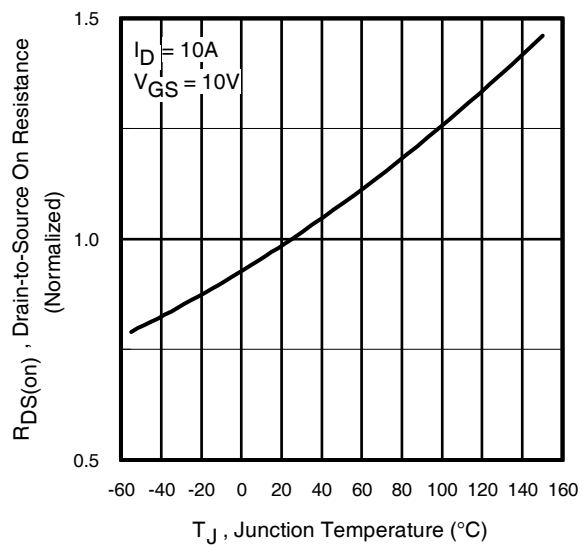

Fig 4. Normalized On-Resistance vs. Temperature

IRF8910PbF

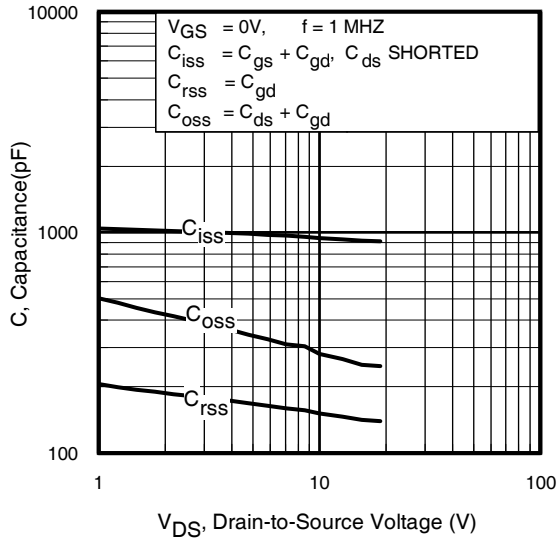

Fig 5. Typical Capacitance vs. Drain-to-Source Voltage

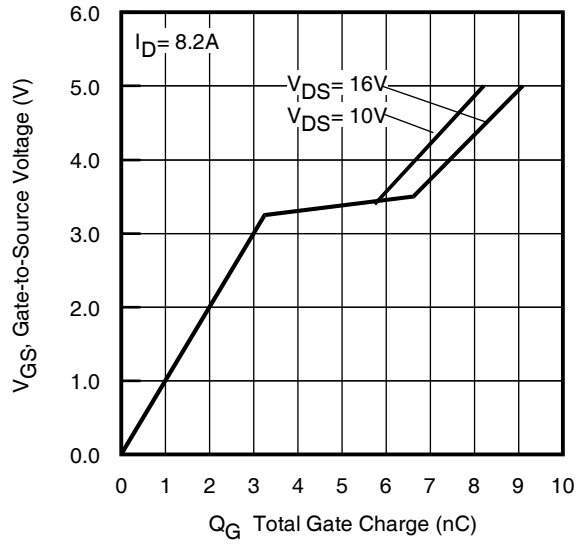

Fig 6. Typical Gate Charge Vs. Gate-to-Source Voltage

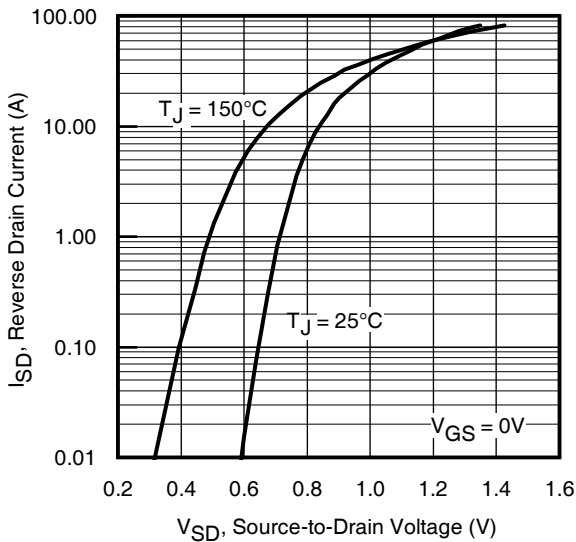

Fig 7. Typical Source-Drain Diode Forward Voltage

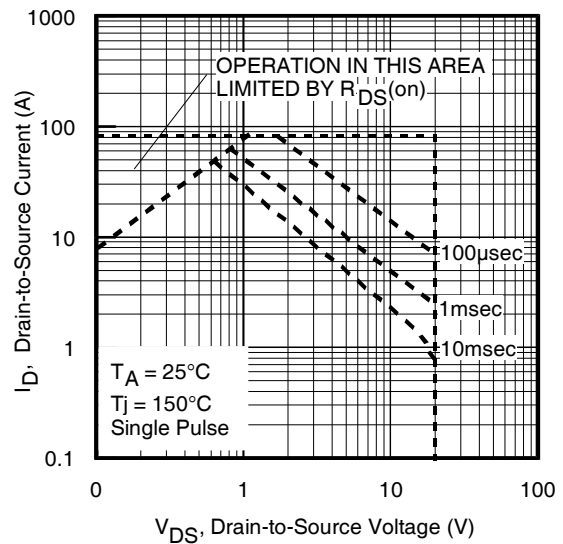

Fig 8. Maximum Safe Operating Area

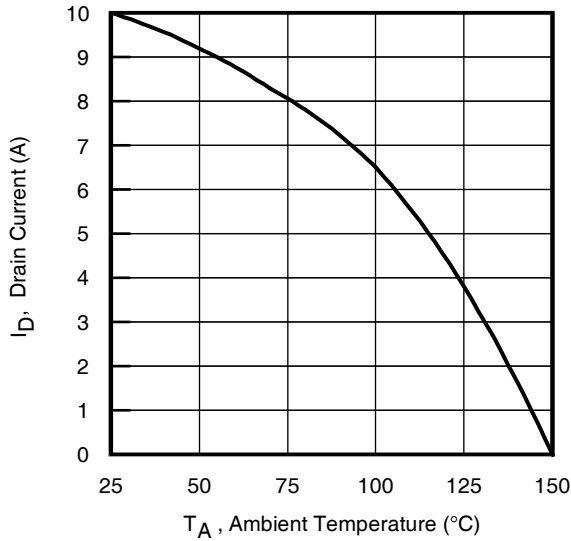

Fig 9. Maximum Drain Current vs. Ambient Temperature

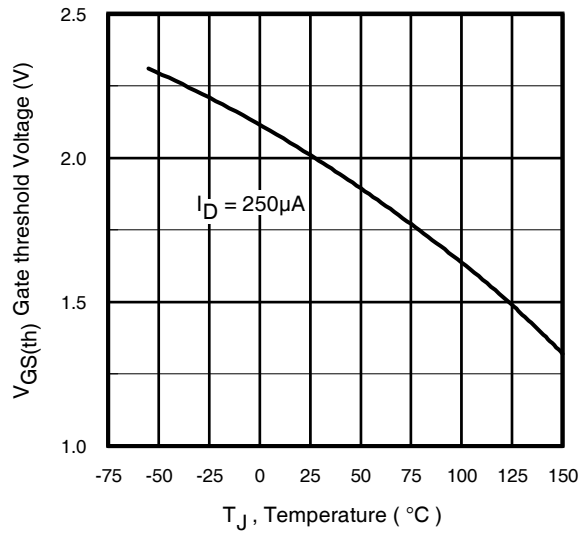

Fig 10. Threshold Voltage vs. Temperature

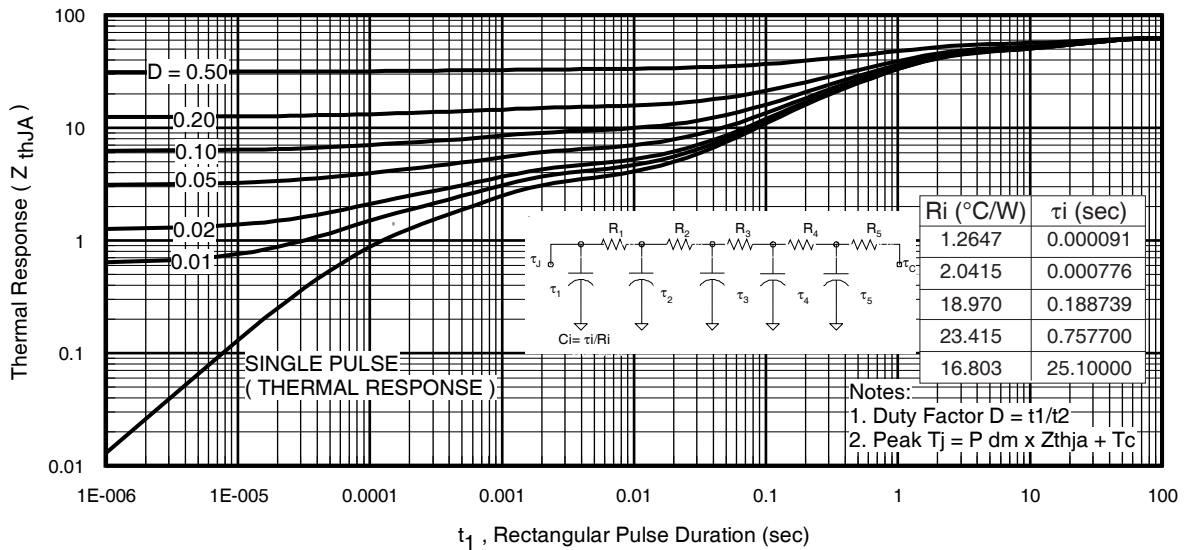

Fig 11. Maximum Effective Transient Thermal Impedance, Junction-to-Ambient

IRF8910PbF

International
IR Rectifier

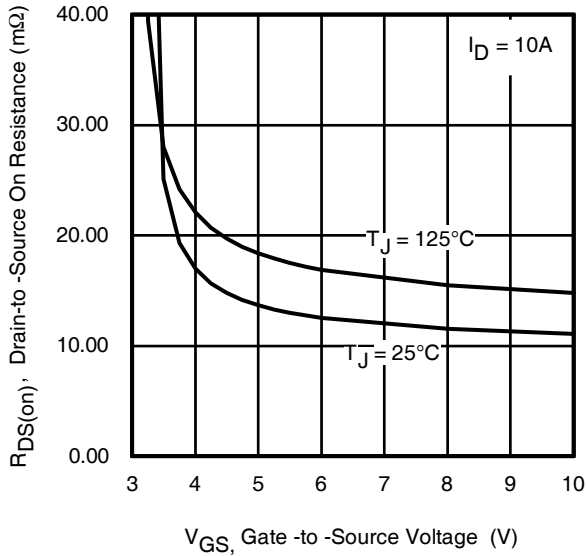

Fig 12. On-Resistance vs. Gate Voltage

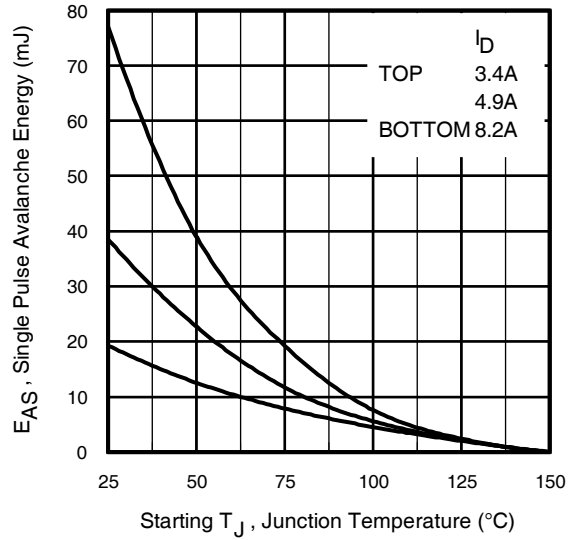

Fig 13. Maximum Avalanche Energy vs. Drain Current

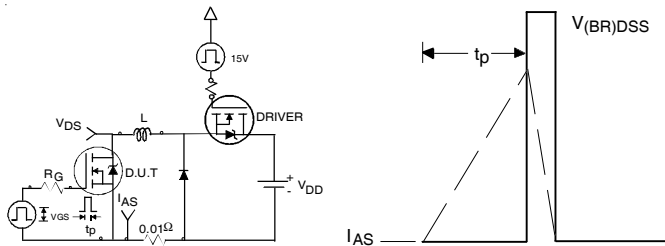

Fig 14. Unclamped Inductive Test Circuit and Waveform

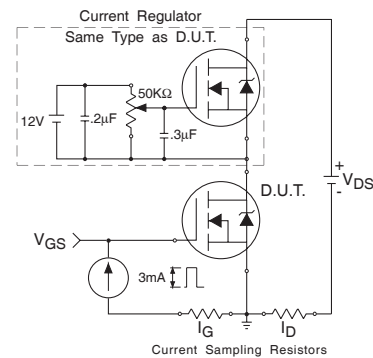

Fig 15. Gate Charge Test Circuit

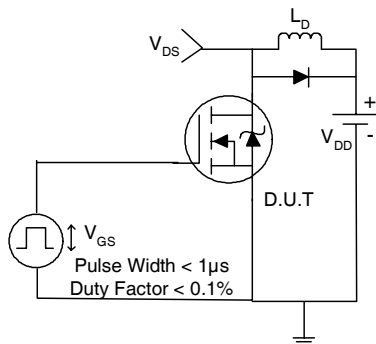

Fig 16. Switching Time Test Circuit

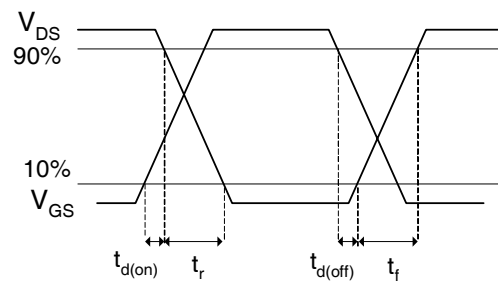

Fig 17. Switching Time Waveforms

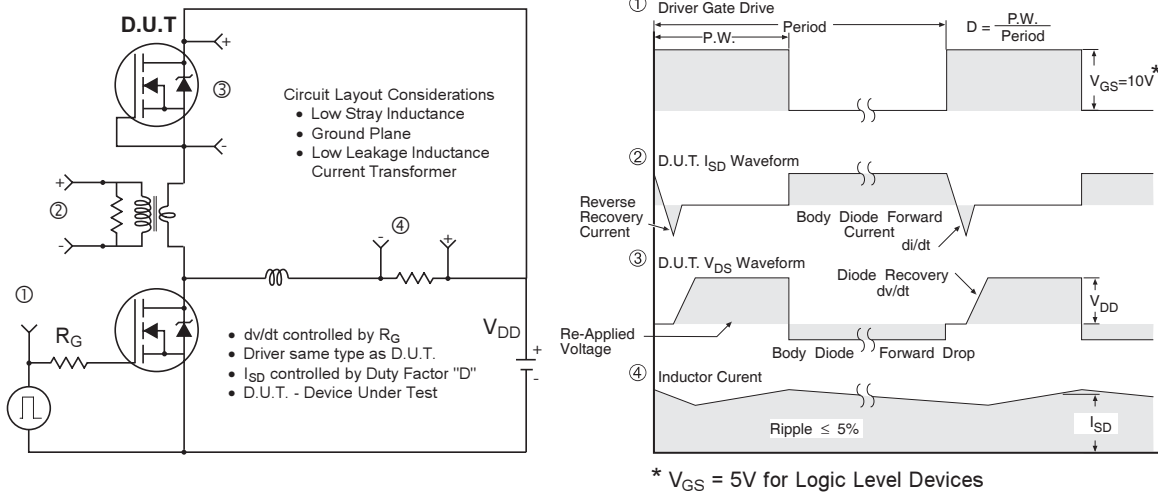

Fig 15. Peak Diode Recovery dv/dt Test Circuit for N-Channel HEXFET® Power MOSFETs

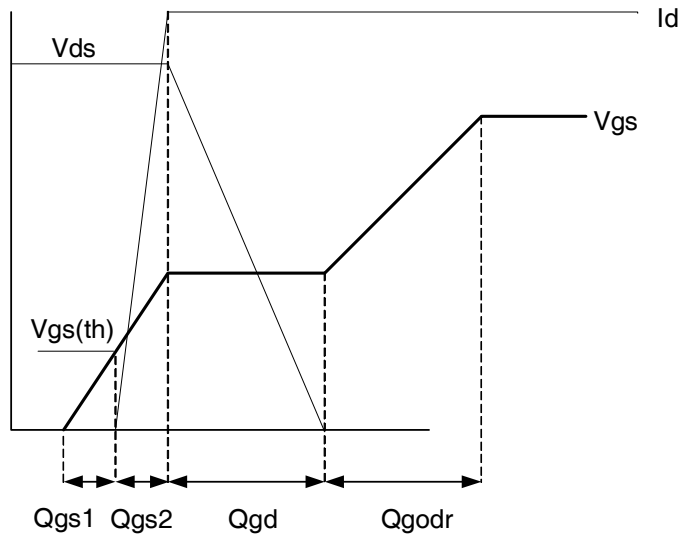

Fig 16. Gate Charge Waveform

Power MOSFET Selection for Non-Isolated DC/DC Converters

Control FET

Special attention has been given to the power losses in the switching elements of the circuit - Q1 and Q2. Power losses in the high side switch Q1, also called the Control FET, are impacted by the $R_{ds(on)}$ of the MOSFET, but these conduction losses are only about one half of the total losses.

Power losses in the control switch Q1 are given by;

$$P_{loss} = P_{conduction} + P_{switching} + P_{drive} + P_{output}$$

This can be expanded and approximated by;

$$P_{loss} = (I_{rms}^2 \times R_{ds(on)}) + \left(I \times \frac{Q_{gd}}{i_g} \times V_{in} \times f \right) + \left(I \times \frac{Q_{gs2}}{i_g} \times V_{in} \times f \right) + (Q_g \times V_g \times f) + \left(\frac{Q_{oss}}{2} \times V_{in} \times f \right)$$

This simplified loss equation includes the terms Q_{gs2} and Q_{oss} which are new to Power MOSFET data sheets.

Q_{gs2} is a sub element of traditional gate-source charge that is included in all MOSFET data sheets. The importance of splitting this gate-source charge into two sub elements, Q_{gs1} and Q_{gs2} , can be seen from Fig 16.

Q_{gs2} indicates the charge that must be supplied by the gate driver between the time that the threshold voltage has been reached and the time the drain current rises to I_{dmax} at which time the drain voltage begins to change. Minimizing Q_{gs2} is a critical factor in reducing switching losses in Q1.

Q_{oss} is the charge that must be supplied to the output capacitance of the MOSFET during every switching cycle. Figure A shows how Q_{oss} is formed by the parallel combination of the voltage dependant (non-linear) capacitance's C_{ds} and C_{dg} when multiplied by the power supply input buss voltage.

Synchronous FET

The power loss equation for Q2 is approximated by;

$$P_{loss} = P_{conduction} + P_{drive} + P_{output}^*$$

$$P_{loss} = (I_{rms}^2 \times R_{ds(on)}) + (Q_g \times V_g \times f) + \left(\frac{Q_{oss}}{2} \times V_{in} \times f \right) + (Q_{rr} \times V_{in} \times f)$$

*dissipated primarily in Q1.

For the synchronous MOSFET Q2, $R_{ds(on)}$ is an important characteristic; however, once again the importance of gate charge must not be overlooked since it impacts three critical areas. Under light load the MOSFET must still be turned on and off by the control IC so the gate drive losses become much more significant. Secondly, the output charge Q_{oss} and reverse recovery charge Q_{rr} both generate losses that are transferred to Q1 and increase the dissipation in that device. Thirdly, gate charge will impact the MOSFETs' susceptibility to Cdv/dt turn on.

The drain of Q2 is connected to the switching node of the converter and therefore sees transitions between ground and V_{in} . As Q1 turns on and off there is a rate of change of drain voltage dV/dt which is capacitively coupled to the gate of Q2 and can induce a voltage spike on the gate that is sufficient to turn the MOSFET on, resulting in shoot-through current. The ratio of Q_{gd}/Q_{gs1} must be minimized to reduce the potential for Cdv/dt turn on.

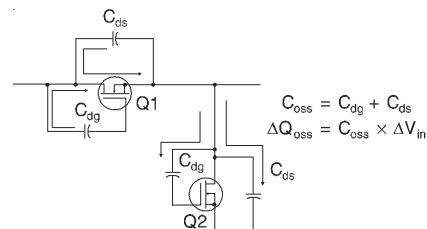
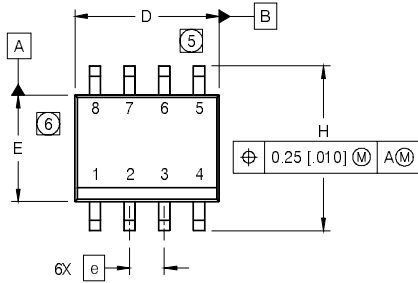

Figure A: Q_{oss} Characteristic

SO-8 Package Outline (MOSFET & Fetky)

Dimensions are shown in millimeters (inches)



| DIM | INCHES | | MILLIMETERS | |
|-----|------------|-------|-------------|------|
| | MIN | MAX | MIN | MAX |
| A | .0532 | .0688 | 1.35 | 1.75 |
| A1 | .0040 | .0098 | 0.10 | 0.25 |
| b | .013 | .020 | 0.33 | 0.51 |
| c | .0075 | .0098 | 0.19 | 0.25 |
| D | .189 | .1968 | 4.80 | 5.00 |
| E | .1497 | .1574 | 3.80 | 4.00 |
| e | .050 BASIC | | 1.27 BASIC | |
| e1 | .025 BASIC | | 0.635 BASIC | |
| H | .2284 | .2440 | 5.80 | 6.20 |
| K | .0099 | .0196 | 0.25 | 0.50 |
| L | .016 | .050 | 0.40 | 1.27 |
| y | 0° | 8° | 0° | 8° |

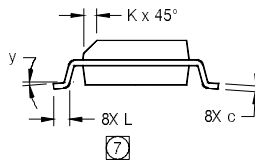
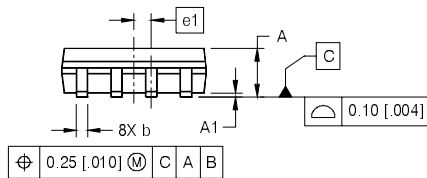

NOTES:

1. DIMENSIONING & TOLERANCING PER ASME Y14.5M-1994.
2. CONTROLLING DIMENSION: MILLIMETER
3. DIMENSIONS ARE SHOWN IN MILLIMETERS [INCHES].
4. OUTLINE CONFORMS TO JEDEC OUTLINE MS-012AA.
- ⑤ DIMENSION DOES NOT INCLUDE MOLD PROTRUSIONS. MOLD PROTRUSIONS NOT TO EXCEED 0.15 [0.006].
- ⑥ DIMENSION DOES NOT INCLUDE MOLD PROTRUSIONS. MOLD PROTRUSIONS NOT TO EXCEED 0.25 [0.010].
- ⑦ DIMENSION IS THE LENGTH OF LEAD FOR SOLDERING TO A SUBSTRATE.

FOOTPRINT

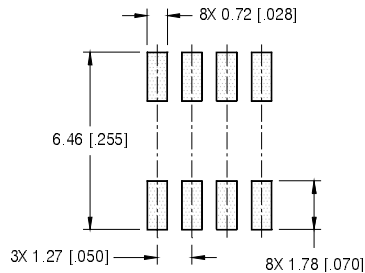

SO-8 Part Marking Information

EXAMPLE: THIS IS AN IRF7101 (MOSFET)

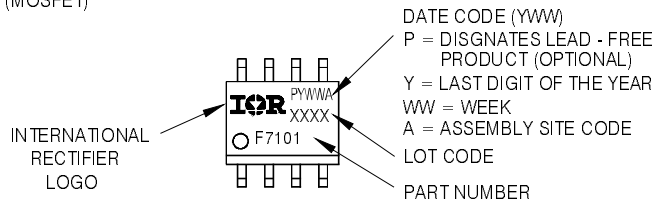

Note: For the most current drawing please refer to IR website at: <http://www.irf.com/package/>

IRF8910PbF

International
IR Rectifier

SO-8 Tape and Reel

Dimensions are shown in millimeters (inches)

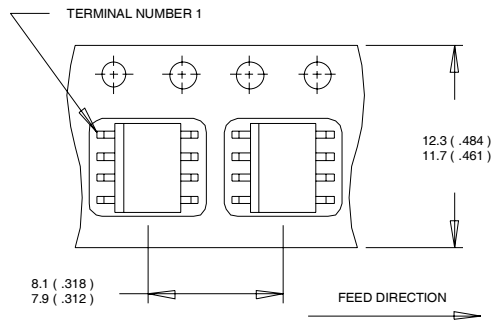

- NOTES:
1. CONTROLLING DIMENSION : MILLIMETER.
 2. ALL DIMENSIONS ARE SHOWN IN MILLIMETERS(INCHES).
 3. OUTLINE CONFORMS TO EIA-481 & EIA-541.

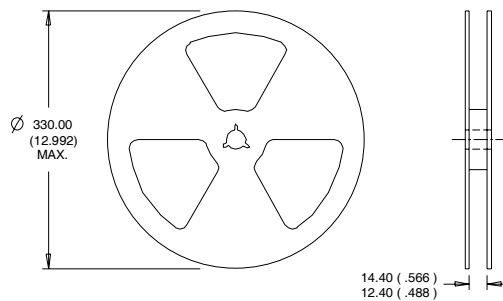

- NOTES :
1. CONTROLLING DIMENSION : MILLIMETER.
 2. OUTLINE CONFORMS TO EIA-481 & EIA-541.

Note: For the most current drawing please refer to IR website at: <http://www.irf.com/package/>

Notes:

- ① Repetitive rating; pulse width limited by max. junction temperature.
- ② Starting $T_J = 25^\circ\text{C}$, $L = 0.57\text{mH}$, $R_G = 25\Omega$, $I_{AS} = 8.2\text{A}$.
- ③ Pulse width $\leq 400\mu\text{s}$; duty cycle $\leq 2\%$.
- ④ When mounted on 1 inch square copper board.
- ⑤ R_{θ} is measured at T_J of approximately 90°C .

Data and specifications subject to change without notice.

This product has been designed and qualified for the Consumer market.

Qualification Standards can be found on IR's Web site.

International
IR Rectifier

IR WORLD HEADQUARTERS: 233 Kansas St., El Segundo, California 90245, USA Tel: (310) 252-7105

TAC Fax: (310) 252-7903

Visit us at www.irf.com for sales contact information. 07/2008

www.irf.com

Looking for pricing, stock, or lifecycle information?

Click below to explore more details on WIN SOURCE:

 [View IRF8910PBF on WIN SOURCE](#)

 [Infineon Technologies](#) Information

Optimize Your Supply Chain with WIN SOURCE Solutions

-  Global Sourcing Solution
-  Obsolete Management
-  Cost Control Management
-  Shortage Management
-  Alternative Solution
-  Excess Inventory Management