



**THE DATASHEET OF
IRF9956PBF**



IRF9956PbF

HEXFET® Power MOSFET

- Generation V Technology
- Ultra Low On-Resistance
- Dual N-Channel MOSFET
- Surface Mount
- Very Low Gate Charge and Switching Losses
- Fully Avalanche Rated
- Lead-Free

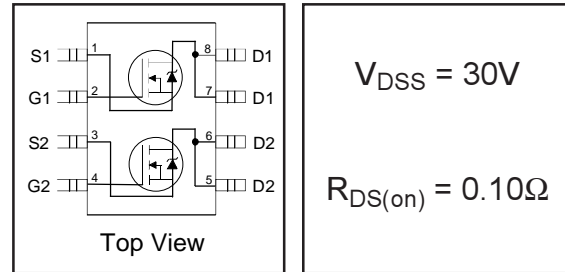

Description

Fifth Generation HEXFETs from International Rectifier utilize advanced processing techniques to achieve extremely low on-resistance per silicon area. This benefit, combined with the fast switching speed and ruggedized device design that HEXFET Power MOSFETs are well known for, provides the designer with an extremely efficient and reliable device for use in a wide variety of applications.

Recommended upgrade: IRF7303 or IRF7313
Lower profile/smaller equivalent: IRF7503

The SO-8 has been modified through a customized leadframe for enhanced thermal characteristics and multiple-die capability making it ideal in a variety of power applications. With these improvements, multiple devices can be used in an application with dramatically reduced board space. The package is designed for vapor phase, infra red, or wave soldering techniques.

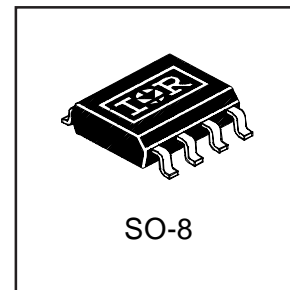

Absolute Maximum Ratings ($T_A = 25^\circ C$ Unless Otherwise Noted)

| | Symbol | Maximum | Units |
|--|----------------|--------------------|------------|
| Drain-Source Voltage | V_{DS} | 30 | V |
| Gate-Source Voltage | V_{GS} | ± 20 | |
| Continuous Drain Current ^① | I_D | $T_A = 25^\circ C$ | A |
| | | $T_A = 70^\circ C$ | |
| Pulsed Drain Current | I_{DM} | 16 | A |
| Continuous Source Current (Diode Conduction) | I_S | 1.7 | |
| Maximum Power Dissipation ^② | P_D | $T_A = 25^\circ C$ | W |
| | | $T_A = 70^\circ C$ | |
| Single Pulse Avalanche Energy ^② | E_{AS} | 44 | mJ |
| Avalanche Current | I_{AR} | 2.0 | A |
| Repetitive Avalanche Energy | E_{AR} | 0.20 | mJ |
| Peak Diode Recovery dv/dt ^③ | dv/dt | 5.0 | V/ ns |
| Junction and Storage Temperature Range | T_J, T_{STG} | -55 to + 150 | $^\circ C$ |

Thermal Resistance Ratings

| Parameter | Symbol | Limit | Units |
|--|-----------------|-------|--------------|
| Maximum Junction-to-Ambient ^④ | $R_{\theta JA}$ | 62.5 | $^\circ C/W$ |

IRF9956PbF

International
IR Rectifier

Electrical Characteristics @ $T_J = 25^\circ\text{C}$ (unless otherwise specified)

| | Parameter | Min. | Typ. | Max. | Units | Conditions |
|---------------------------------|--------------------------------------|------|-------|------|---------------------|--|
| $V_{(BR)DSS}$ | Drain-to-Source Breakdown Voltage | 30 | — | — | V | $V_{GS} = 0V, I_D = 250\mu A$ |
| $\Delta V_{(BR)DSS}/\Delta T_J$ | Breakdown Voltage Temp. Coefficient | — | 0.015 | — | V/ $^\circ\text{C}$ | Reference to $25^\circ\text{C}, I_D = 1\text{mA}$ |
| $R_{DS(on)}$ | Static Drain-to-Source On-Resistance | — | 0.06 | 0.10 | Ω | $V_{GS} = 10V, I_D = 2.2A$ ④ |
| | | — | 0.09 | 0.20 | | $V_{GS} = 4.5V, I_D = 1.0A$ ④ |
| $V_{GS(th)}$ | Gate Threshold Voltage | 1.0 | — | — | V | $V_{DS} = V_{GS}, I_D = 250\mu A$ |
| g_{fs} | Forward Transconductance | — | 12 | — | S | $V_{DS} = 15V, I_D = 3.5A$ |
| I_{DSS} | Drain-to-Source Leakage Current | — | — | 2.0 | μA | $V_{DS} = 24V, V_{GS} = 0V$ |
| | | — | — | 25 | | $V_{DS} = 24V, V_{GS} = 0V, T_J = 125^\circ\text{C}$ |
| I_{GSS} | Gate-to-Source Forward Leakage | — | — | 100 | nA | $V_{GS} = 24V$ |
| | Gate-to-Source Reverse Leakage | — | — | -100 | | $V_{GS} = -24V$ |
| Q_g | Total Gate Charge | — | 6.9 | 14 | nC | $I_D = 1.8A$ |
| Q_{gs} | Gate-to-Source Charge | — | 1.0 | 2.0 | | $V_{DS} = 10V$ |
| Q_{gd} | Gate-to-Drain ("Miller") Charge | — | 1.8 | 3.5 | | $V_{GS} = 10V, \text{See Fig. 10 } \textcircled{4}$ |
| $t_{d(on)}$ | Turn-On Delay Time | — | 6.2 | 12 | ns | $V_{DD} = 10V$ |
| t_r | Rise Time | — | 8.8 | 18 | | $I_D = 1.0A$ |
| $t_{d(off)}$ | Turn-Off Delay Time | — | 13 | 26 | | $R_G = 6.0\Omega$ |
| t_f | Fall Time | — | 3.0 | 6.0 | | $R_D = 10\Omega$ ④ |
| C_{iss} | Input Capacitance | — | 190 | — | pF | $V_{GS} = 0V$ |
| C_{oss} | Output Capacitance | — | 120 | — | | $V_{DS} = 15V$ |
| C_{riss} | Reverse Transfer Capacitance | — | 61 | — | | $f = 1.0\text{MHz}, \text{See Fig. 9}$ |

Source-Drain Ratings and Characteristics

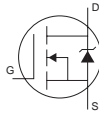
| | Parameter | Min. | Typ. | Max. | Units | Conditions |
|----------|--|------|------|------|-------|--|
| I_S | Continuous Source Current (Body Diode) | — | — | 1.7 | A | MOSFET symbol showing the integral reverse p-n junction diode.  |
| I_{SM} | Pulsed Source Current (Body Diode) ① | — | — | 16 | | |
| V_{SD} | Diode Forward Voltage | — | 0.82 | 1.2 | V | $T_J = 25^\circ\text{C}, I_S = 1.25A, V_{GS} = 0V$ ③ |
| t_{rr} | Reverse Recovery Time | — | 27 | 53 | ns | $T_J = 25^\circ\text{C}, I_F = 1.25A$ |
| Q_{rr} | Reverse Recovery Charge | — | 28 | 57 | nC | $di/dt = 100A/\mu s$ ③ |

Notes:

- ① Repetitive rating; pulse width limited by max. junction temperature. (See fig. 11)
- ② Starting $T_J = 25^\circ\text{C}, L = 22\text{mH}$
 $R_G = 25\Omega, I_{AS} = 2.0A.$
- ③ $I_{SD} \leq 2.0A, di/dt \leq 100A/\mu s, V_{DD} \leq V_{(BR)DSS}, T_J \leq 150^\circ\text{C}$
- ④ Pulse width $\leq 300\mu s$; duty cycle $\leq 2\%$.
- ⑤ Surface mounted on FR-4 board, $t \leq 10\text{sec}.$

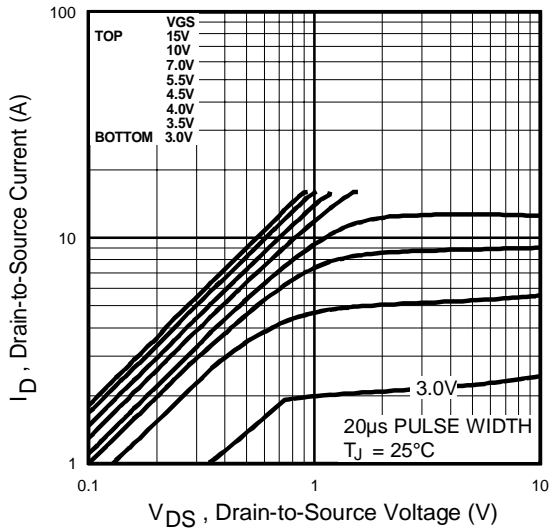

Fig 1. Typical Output Characteristics

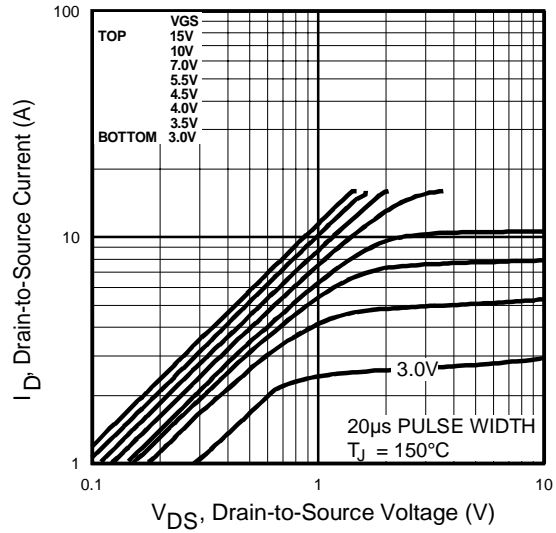

Fig 2. Typical Output Characteristics

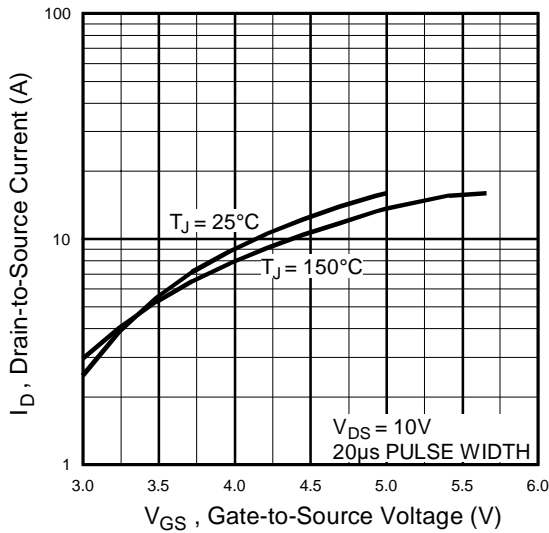

Fig 3. Typical Transfer Characteristics

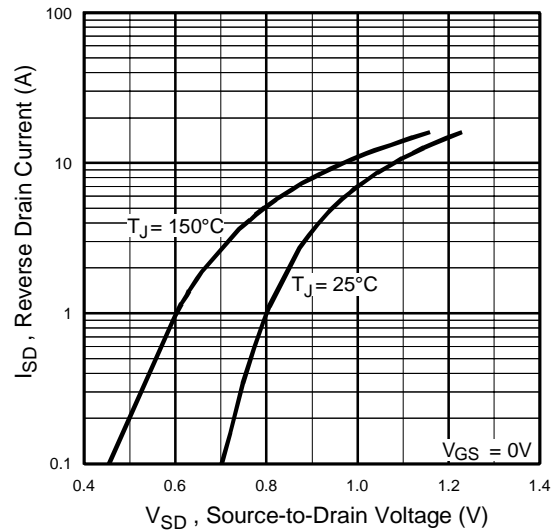

Fig 4. Typical Source-Drain Diode Forward Voltage

IRF9956PbF

International
IR Rectifier

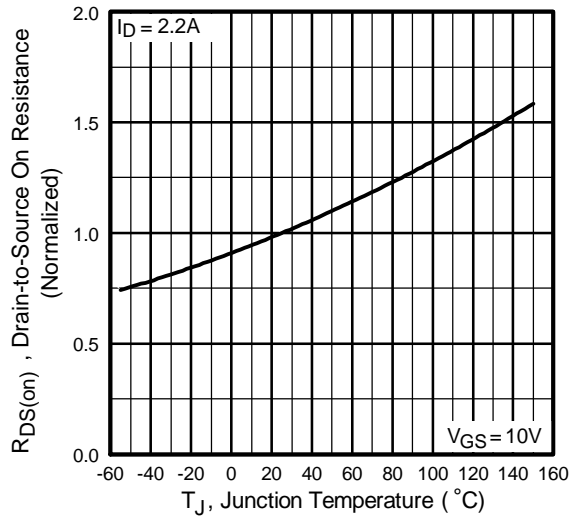

Fig 4. Normalized On-Resistance Vs. Temperature

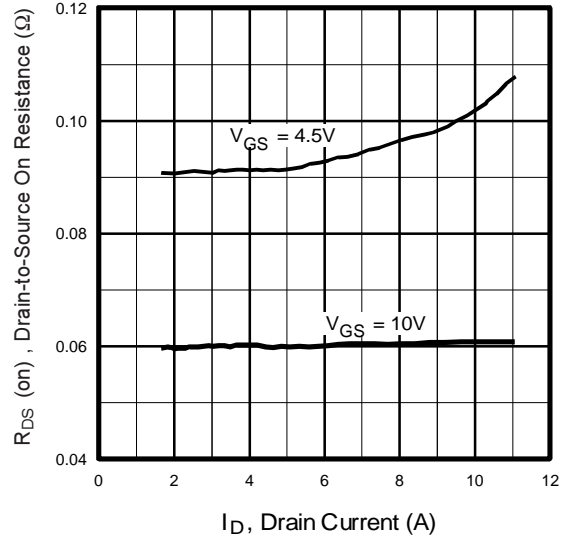

Fig 6. Typical On-Resistance Vs. Drain Current

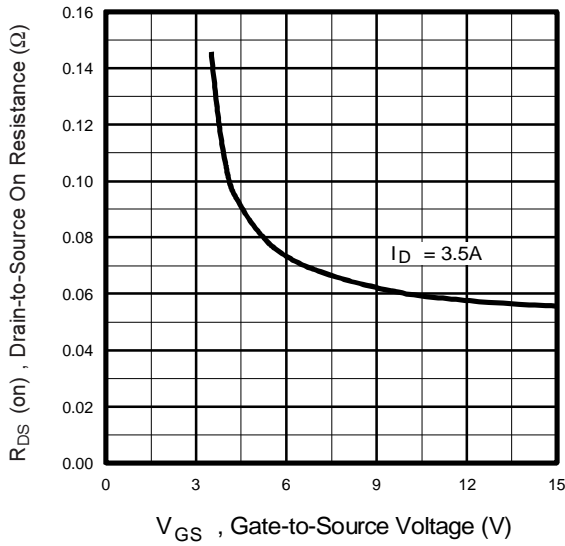

Fig 7. Typical On-Resistance Vs. Gate Voltage

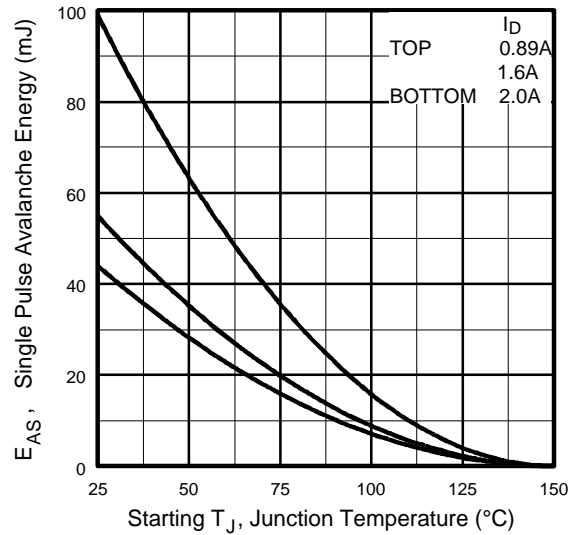

Fig 8. Maximum Avalanche Energy Vs. Drain Current

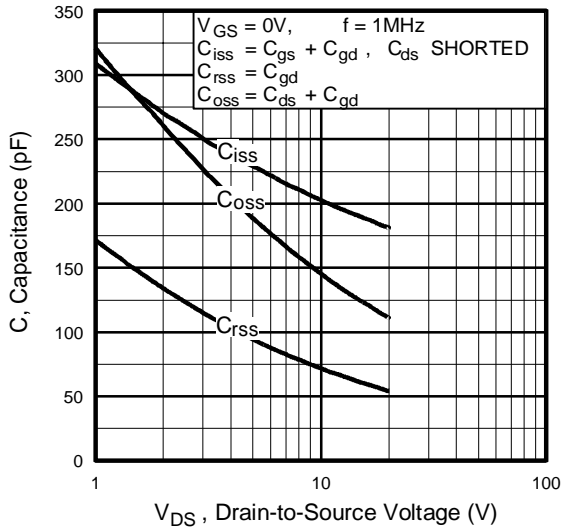

Fig 9. Typical Capacitance Vs. Drain-to-Source Voltage

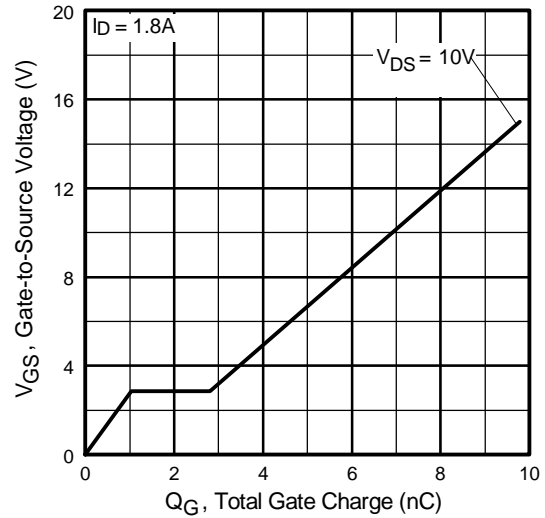

Fig 10. Typical Gate Charge Vs. Gate-to-Source Voltage

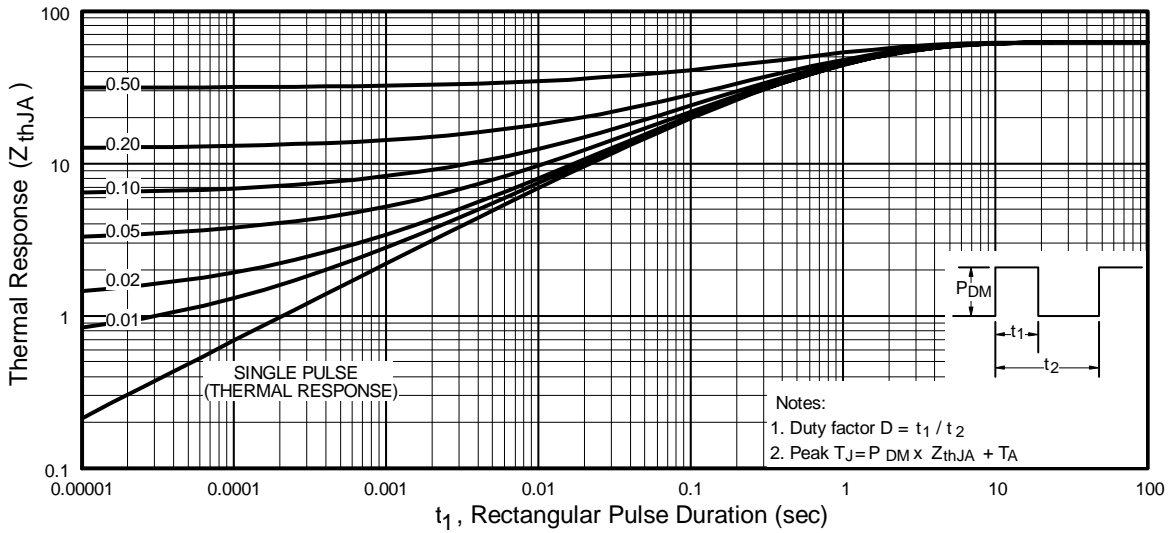

Fig 11. Maximum Effective Transient Thermal Impedance, Junction-to-Ambient

IRF9956PbF

International
IR Rectifier

SO-8 Package Outline

Dimensions are shown in millimeters (inches)

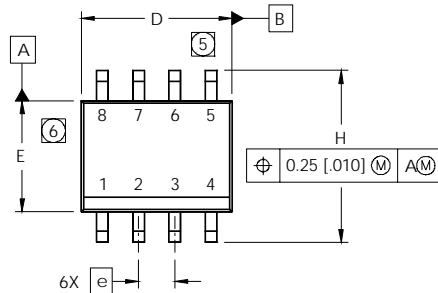

| DIM | INCHES | | MILLIMETERS | |
|-----|------------|-------|-------------|------|
| | MIN | MAX | MIN | MAX |
| A | .0532 | .0688 | 1.35 | 1.75 |
| A1 | .0040 | .0098 | 0.10 | 0.25 |
| b | .013 | .020 | 0.33 | 0.51 |
| c | .0075 | .0098 | 0.19 | 0.25 |
| D | .189 | .1968 | 4.80 | 5.00 |
| E | .1497 | .1574 | 3.80 | 4.00 |
| e | .050 BASIC | | 1.27 BASIC | |
| e1 | .025 BASIC | | 0.635 BASIC | |
| H | .2284 | .2440 | 5.80 | 6.20 |
| K | .0099 | .0196 | 0.25 | 0.50 |
| L | .016 | .050 | 0.40 | 1.27 |
| y | 0° | 8° | 0° | 8° |

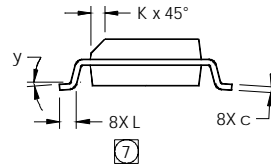
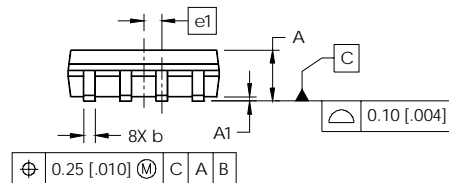

NOTES:

- DIMENSIONING & TOLERANCING PER ASME Y14.5M-1994.
- CONTROLLING DIMENSION: MILLIMETER
- DIMENSIONS ARE SHOWN IN MILLIMETERS [INCHES].
- OUTLINE CONFORMS TO JEDEC OUTLINE MS-012AA
- (5)** DIMENSION DOES NOT INCLUDE MOLD PROTRUSIONS. MOLD PROTRUSIONS NOT TO EXCEED 0.15 [0.006].
- (6)** DIMENSION DOES NOT INCLUDE MOLD PROTRUSIONS. MOLD PROTRUSIONS NOT TO EXCEED 0.25 [0.010].
- (7)** DIMENSION IS THE LENGTH OF LEAD FOR SOLDERING TO A SUBSTRATE.

FOOTPRINT

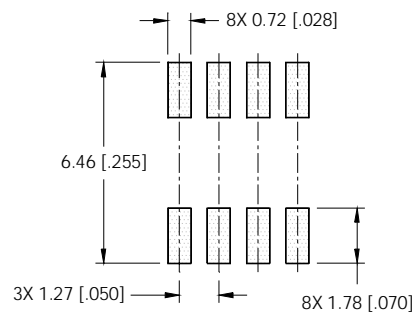

SO-8 Part Marking

EXAMPLE: THIS IS AN IRF7101 (MOSFET)

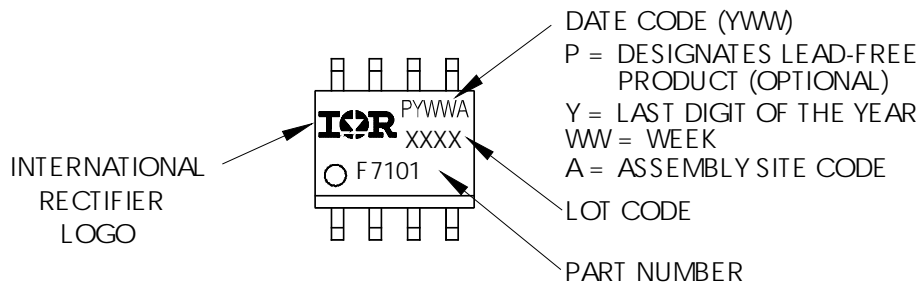

SO-8 Tape and Reel

Dimensions are shown in millimeters (inches)

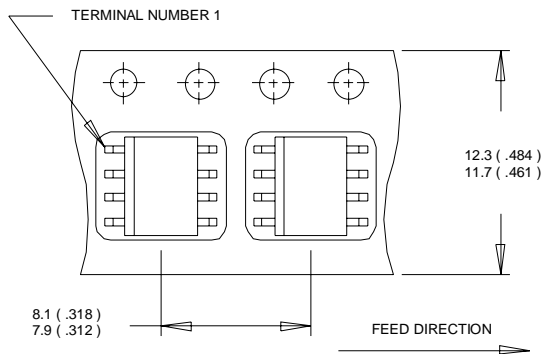

NOTES:

1. CONTROLLING DIMENSION : MILLIMETER.
2. ALL DIMENSIONS ARE SHOWN IN MILLIMETERS(INCHES).
3. OUTLINE CONFORMS TO EIA-481 & EIA-541.

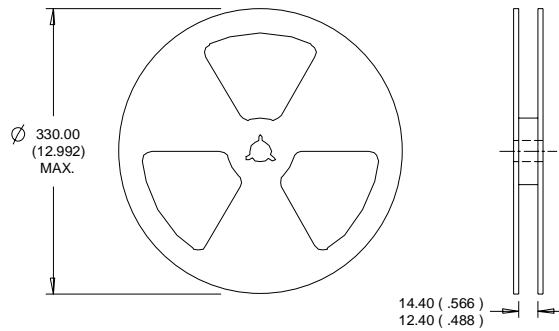

NOTES :

1. CONTROLLING DIMENSION : MILLIMETER.
2. OUTLINE CONFORMS TO EIA-481 & EIA-541.

Data and specifications subject to change without notice.
 This product has been designed and qualified for the Consumer market.
 Qualifications Standards can be found on IR's Web site.

Looking for pricing, stock, or lifecycle information?

Click below to explore more details on WIN SOURCE:

 [View IRF9956PBF on WIN SOURCE](#)

 [Infineon Technologies](#) Information

Optimize Your Supply Chain with WIN SOURCE Solutions

-  Global Sourcing Solution
-  Obsolete Management
-  Cost Control Management
-  Shortage Management
-  Alternative Solution
-  Excess Inventory Management