



**THE DATASHEET OF  
IRFB3206GPBF**



HEXFET® Power MOSFET

**Applications**

- High Efficiency Synchronous Rectification in SMPS
- Uninterruptible Power Supply
- High Speed Power Switching
- Hard Switched and High Frequency Circuits

**Benefits**

- Improved Gate, Avalanche and Dynamic  $dV/dt$  Ruggedness
- Fully Characterized Capacitance and Avalanche SOA
- Enhanced body diode  $dV/dt$  and  $dI/dt$  Capability
- Lead-Free
- Halogen-Free

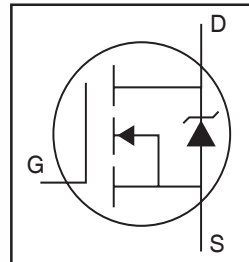

$V_{DSS}$	<b>60V</b>
$R_{DS(on)}$ <b>typ. max.</b>	<b>2.4mΩ</b> <b>3.0mΩ</b>
$I_D$ (Silicon Limited)	<b>210A</b> ①
$I_D$ (Package Limited)	<b>120A</b>

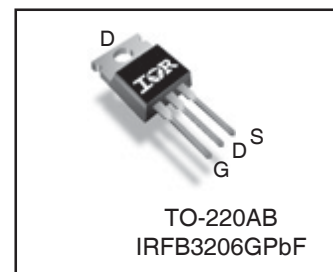

<b>G</b>	<b>D</b>	<b>S</b>
Gate	Drain	Source

**Absolute Maximum Ratings**

Symbol	Parameter	Max.	Units
$I_D @ T_C = 25^\circ C$	Continuous Drain Current, $V_{GS} @ 10V$ (Silicon Limited)	210①	A
$I_D @ T_C = 100^\circ C$	Continuous Drain Current, $V_{GS} @ 10V$ (Silicon Limited)	150①	
$I_D @ T_C = 25^\circ C$	Continuous Drain Current, $V_{GS} @ 10V$ (Wire Bond Limited)	120	
$I_{DM}$	Pulsed Drain Current ②	840	
$P_D @ T_C = 25^\circ C$	Maximum Power Dissipation	300	W
	Linear Derating Factor	2.0	W/°C
$V_{GS}$	Gate-to-Source Voltage	$\pm 20$	V
$dv/dt$	Peak Diode Recovery ④	5.0	V/ns
$T_J$ $T_{STG}$	Operating Junction and Storage Temperature Range	-55 to + 175	°C
	Soldering Temperature, for 10 seconds (1.6mm from case)	300	
	Mounting torque, 6-32 or M3 screw	10lbf·in (1.1N·m)	

**Avalanche Characteristics**

$E_{AS}$ (Thermally limited)	Single Pulse Avalanche Energy ③	170	mJ
$I_{AR}$	Avalanche Current ②	See Fig. 14, 15, 22a, 22b,	A
$E_{AR}$	Repetitive Avalanche Energy ②		mJ

**Thermal Resistance**

Symbol	Parameter	Typ.	Max.	Units
$R_{\theta JC}$	Junction-to-Case ⑧	—	0.50	°C/W
$R_{\theta CS}$	Case-to-Sink, Flat Greased Surface , TO-220	0.50	—	
$R_{\theta JA}$	Junction-to-Ambient, TO-220	—	62	

Static @  $T_J = 25^\circ\text{C}$  (unless otherwise specified)

Symbol	Parameter	Min.	Typ.	Max.	Units	Conditions
$V_{(BR)DSS}$	Drain-to-Source Breakdown Voltage	60	—	—	V	$V_{GS} = 0V, I_D = 250\mu A$
$\Delta V_{(BR)DSS}/\Delta T_J$	Breakdown Voltage Temp. Coefficient	—	0.07	—	V/°C	Reference to $25^\circ\text{C}$ , $I_D = 5mA$ ②
$R_{DS(on)}$	Static Drain-to-Source On-Resistance	—	2.4	3.0	mΩ	$V_{GS} = 10V, I_D = 75A$ ③
$V_{GS(th)}$	Gate Threshold Voltage	2.0	—	4.0	V	$V_{DS} = V_{GS}, I_D = 150\mu A$
$I_{bSS}$	Drain-to-Source Leakage Current	—	—	20	μA	$V_{DS} = 60V, V_{GS} = 0V$
		—	—	250		$V_{DS} = 48V, V_{GS} = 0V, T_J = 125^\circ\text{C}$
$I_{GSS}$	Gate-to-Source Forward Leakage	—	—	100	nA	$V_{GS} = 20V$
	Gate-to-Source Reverse Leakage	—	—	-100		$V_{GS} = -20V$
$R_G$	Internal Gate Resistance	—	0.7	—	Ω	

Dynamic @  $T_J = 25^\circ\text{C}$  (unless otherwise specified)

Symbol	Parameter	Min.	Typ.	Max.	Units	Conditions
gfs	Forward Transconductance	210	—	—	S	$V_{DS} = 50V, I_D = 75A$
$Q_g$	Total Gate Charge	—	120	170	nC	$I_D = 75A$
$Q_{gs}$	Gate-to-Source Charge	—	29	—		$V_{DS} = 30V$
$Q_{gd}$	Gate-to-Drain ("Miller") Charge	—	35	—		$V_{GS} = 10V$ ⑤
$Q_{sync}$	Total Gate Charge Sync. ( $Q_g - Q_{gd}$ )	—	85	—		$I_D = 75A, V_{DS} = 0V, V_{GS} = 10V$
$t_{d(on)}$	Turn-On Delay Time	—	19	—	ns	$V_{DD} = 30V$
$t_r$	Rise Time	—	82	—		$I_D = 75A$
$t_{d(off)}$	Turn-Off Delay Time	—	55	—		$R_G = 2.7\Omega$
$t_f$	Fall Time	—	83	—		$V_{GS} = 10V$ ⑤
$C_{iss}$	Input Capacitance	—	6540	—	pF	$V_{GS} = 0V$
$C_{oss}$	Output Capacitance	—	720	—		$V_{DS} = 50V$
$C_{rss}$	Reverse Transfer Capacitance	—	360	—		$f = 1.0MHz$ , See Fig.5
$C_{oss\ eff. (ER)}$	Effective Output Capacitance (Energy Related)	—	1040	—		$V_{GS} = 0V, V_{DS} = 0V$ to $48V$ ⑦, See Fig.11
$C_{oss\ eff. (TR)}$	Effective Output Capacitance (Time Related) ⑧	—	1230	—		$V_{GS} = 0V, V_{DS} = 0V$ to $48V$ ⑧

## Diode Characteristics

Symbol	Parameter	Min.	Typ.	Max.	Units	Conditions
$I_S$	Continuous Source Current (Body Diode)	—	—	210 ①	A	MOSFET symbol showing the integral reverse p-n junction diode.
$I_{SM}$	Pulsed Source Current (Body Diode) ②	—	—	840	A	
$V_{SD}$	Diode Forward Voltage	—	—	1.3	V	$T_J = 25^\circ\text{C}, I_S = 75A, V_{GS} = 0V$ ⑤
$t_{rr}$	Reverse Recovery Time	—	33	50	ns	$T_J = 25^\circ\text{C}$ $V_R = 51V,$
		—	37	56		$T_J = 125^\circ\text{C}$ $I_F = 75A$
$Q_{rr}$	Reverse Recovery Charge	—	41	62	nC	$T_J = 25^\circ\text{C}$ $di/dt = 100A/\mu s$ ⑤
		—	53	80		$T_J = 125^\circ\text{C}$
$I_{RRM}$	Reverse Recovery Current	—	2.1	—	A	$T_J = 25^\circ\text{C}$
$t_{on}$	Forward Turn-On Time	Intrinsic turn-on time is negligible (turn-on is dominated by LS+LD)				

### Notes:

- ① Calculated continuous current based on maximum allowable junction temperature. Bond wire current limit is 120A. Note that current limitations arising from heating of the device leads may occur with some lead mounting arrangements.
- ② Repetitive rating; pulse width limited by max. junction temperature.
- ③ Limited by  $T_{Jmax}$ , starting  $T_J = 25^\circ\text{C}$ ,  $L = 0.023mH$   
 $R_G = 25\Omega, I_{AS} = 120A, V_{GS} = 10V$ . Part not recommended for use above this value.
- ④  $I_{SD} \leq 75A, di/dt \leq 360A/\mu s, V_{DD} \leq V_{(BR)DSS}, T_J \leq 175^\circ\text{C}$ .
- ⑤ Pulse width  $\leq 400\mu s$ ; duty cycle  $\leq 2\%$ .
- ⑥  $C_{oss\ eff. (TR)}$  is a fixed capacitance that gives the same charging time as  $C_{oss}$  while  $V_{DS}$  is rising from 0 to 80%  $V_{DSS}$ .
- ⑦  $C_{oss\ eff. (ER)}$  is a fixed capacitance that gives the same energy as  $C_{oss}$  while  $V_{DS}$  is rising from 0 to 80%  $V_{DSS}$ .
- ⑧  $R_\theta$  is measured at  $T_J$  approximately  $90^\circ\text{C}$

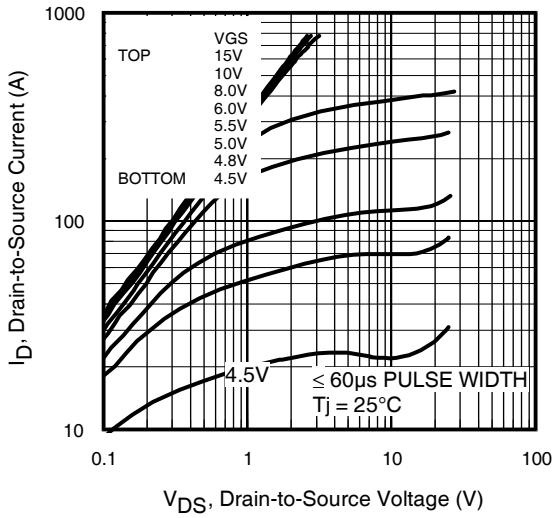

Fig 1. Typical Output Characteristics

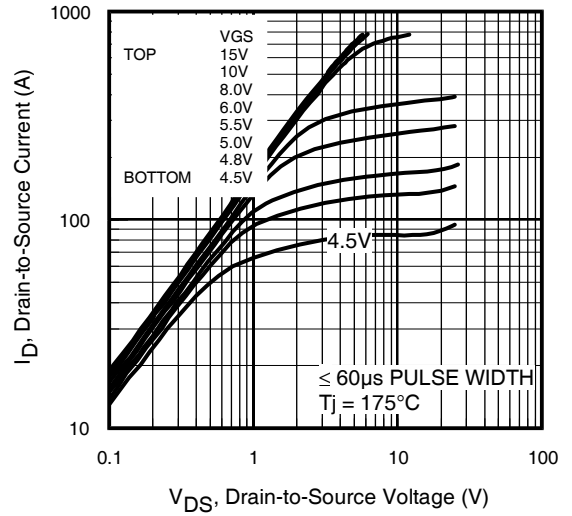

Fig 2. Typical Output Characteristics

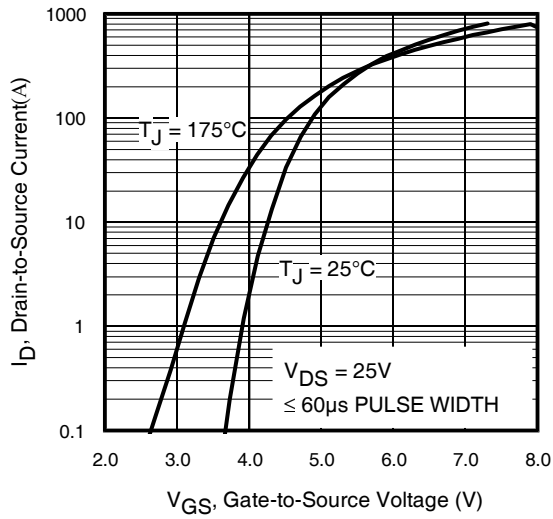

Fig 3. Typical Transfer Characteristics

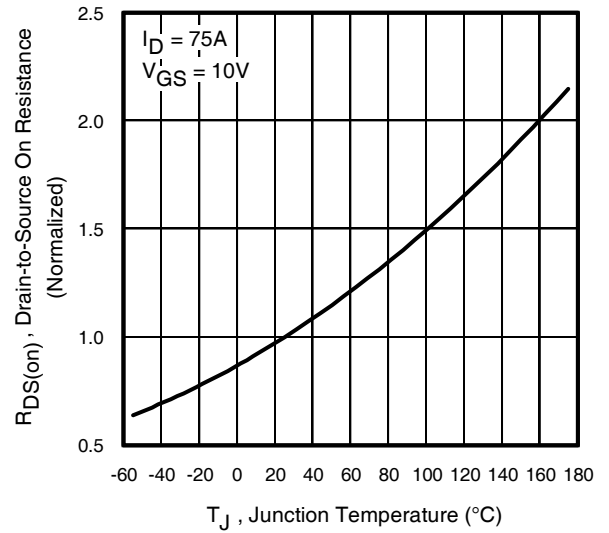

Fig 4. Normalized On-Resistance vs. Temperature

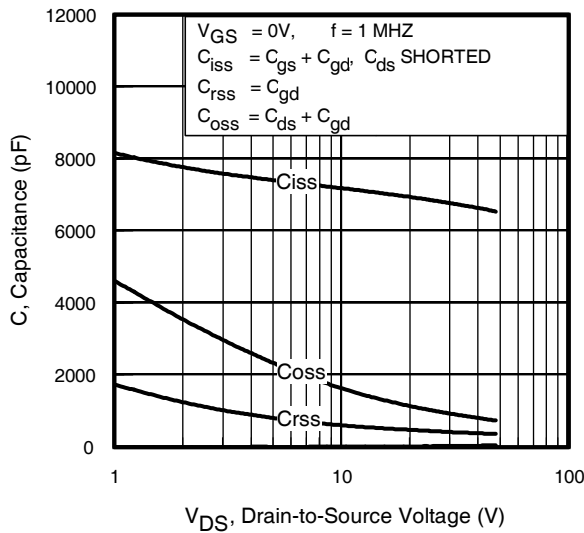

Fig 5. Typical Capacitance vs. Drain-to-Source Voltage

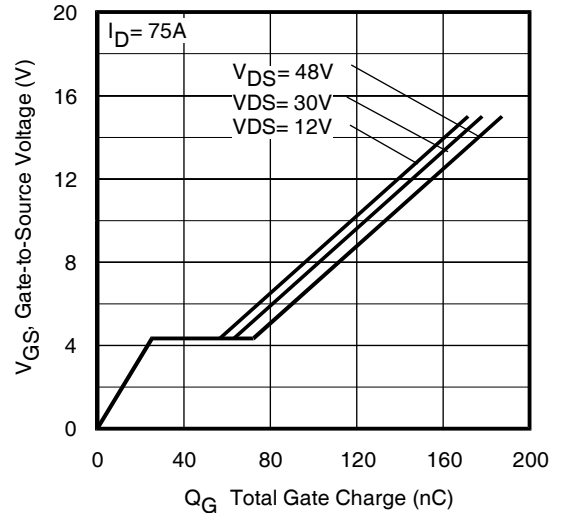
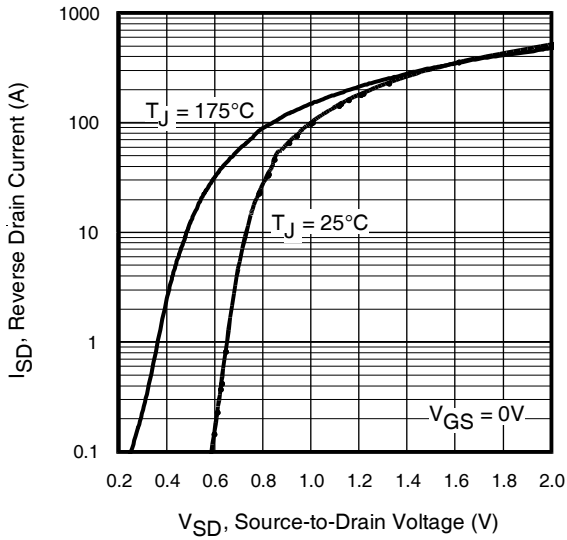
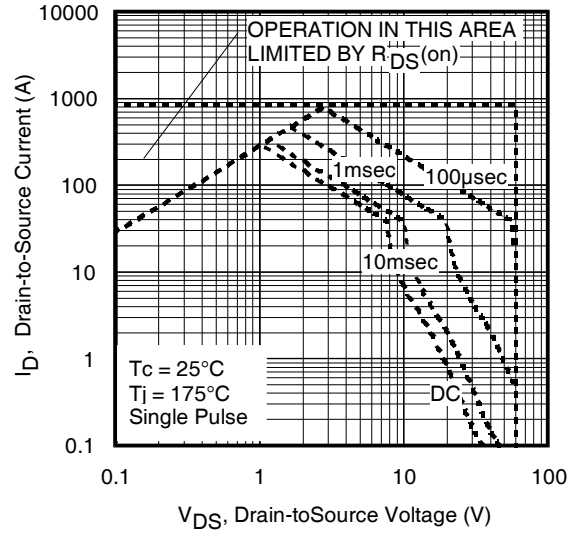

Fig 6. Typical Gate Charge vs. Gate-to-Source Voltage



**Fig 7.** Typical Source-Drain Diode Forward Voltage



**Fig 8.** Maximum Safe Operating Area

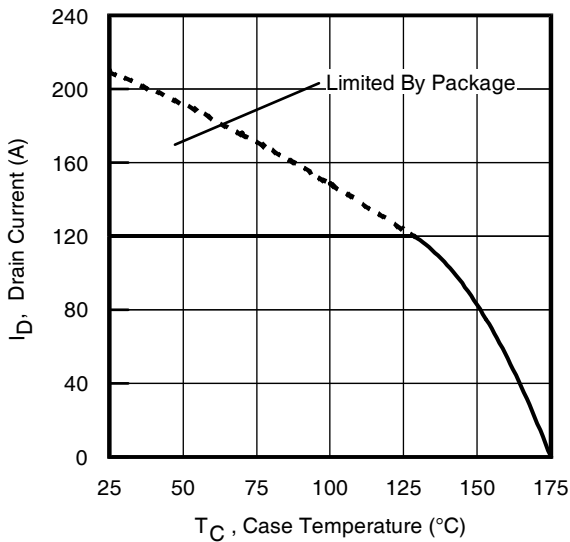

**Fig 9.** Maximum Drain Current vs. Case Temperature

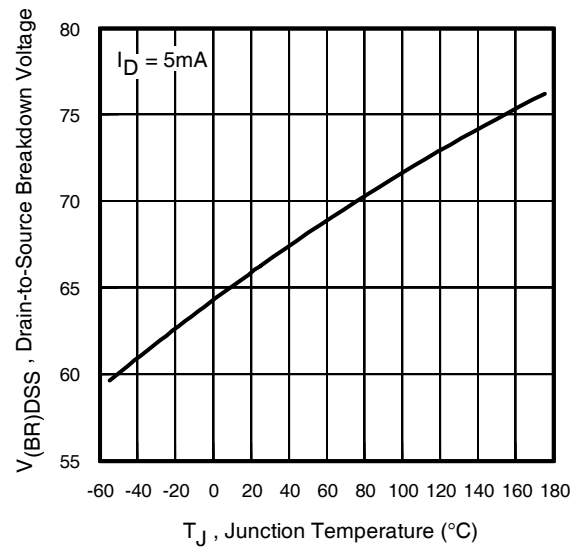

**Fig 10.** Drain-to-Source Breakdown Voltage

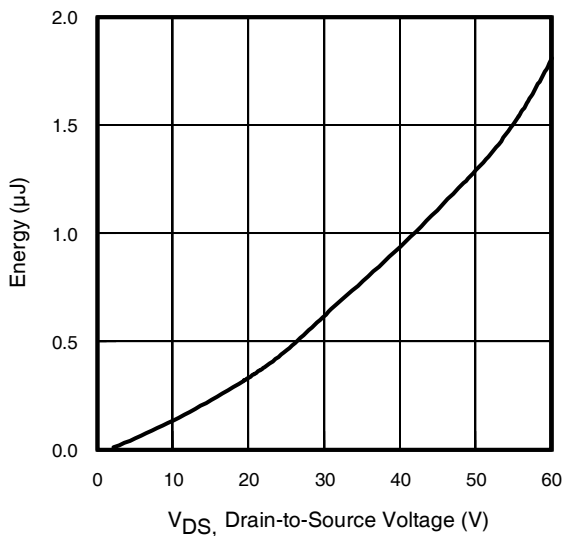

**Fig 11.** Typical  $C_{OSS}$  Stored Energy

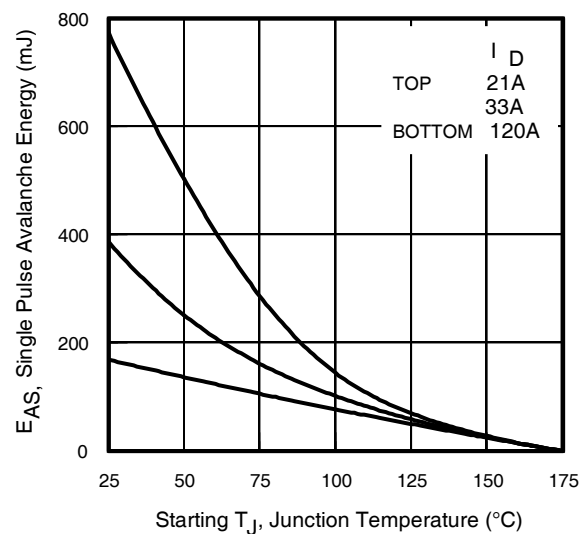

**Fig 12.** Maximum Avalanche Energy Vs. Drain Current

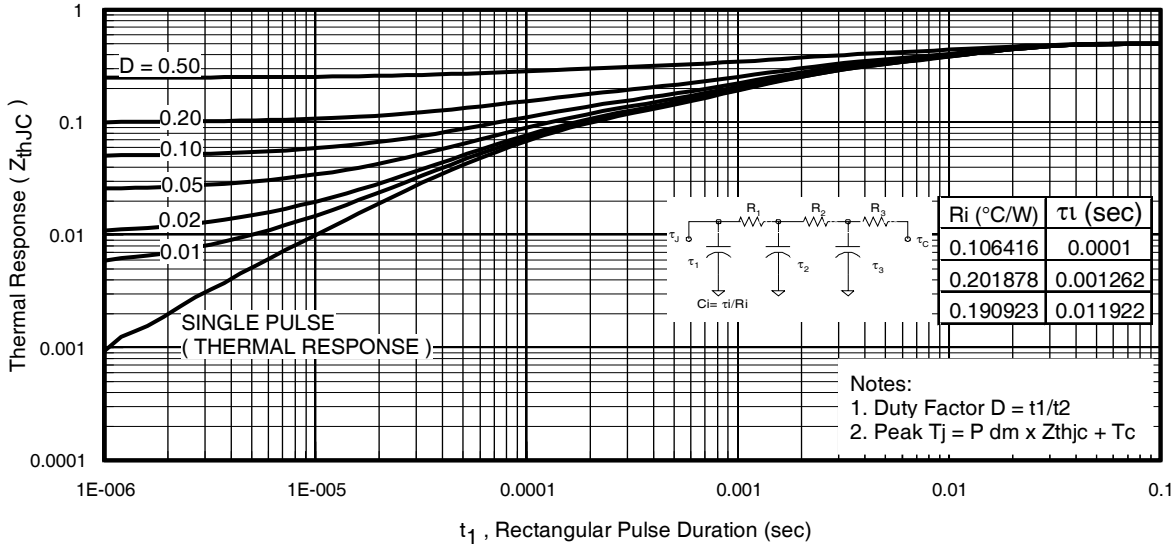

Fig 13. Maximum Effective Transient Thermal Impedance, Junction-to-Case

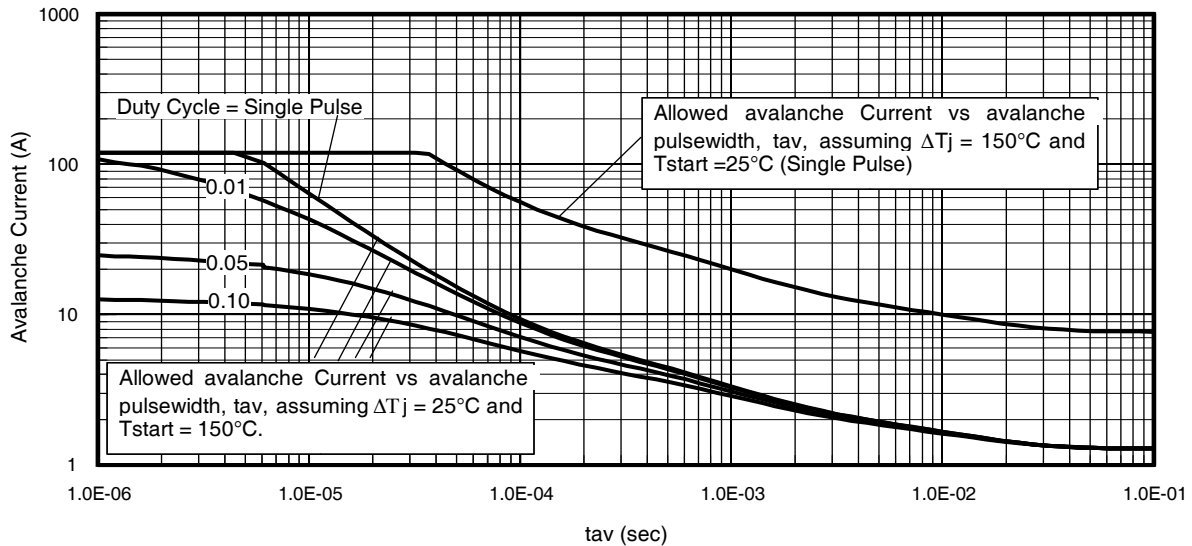
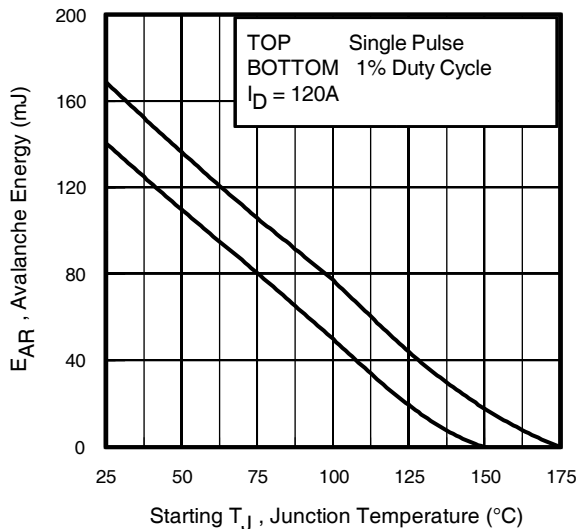

Fig 14. Typical Avalanche Current vs. Pulsewidth



**Notes on Repetitive Avalanche Curves , Figures 14, 15:**  
(For further info, see AN-1005 at [www.irf.com](http://www.irf.com))

1. Avalanche failures assumption:  
Purely a thermal phenomenon and failure occurs at a temperature far in excess of  $T_{jmax}$ . This is validated for every part type.
2. Safe operation in Avalanche is allowed as long as  $T_{jmax}$  is not exceeded.
3. Equation below based on circuit and waveforms shown in Figures 16a, 16b.
4.  $P_{D(ave)}$  = Average power dissipation per single avalanche pulse.
5. BV = Rated breakdown voltage (1.3 factor accounts for voltage increase during avalanche).
6.  $I_{av}$  = Allowable avalanche current.
7.  $\Delta T$  = Allowable rise in junction temperature, not to exceed  $T_{jmax}$  (assumed as 25°C in Figure 14, 15).  
 $t_{av}$  = Average time in avalanche.  
 $D$  = Duty cycle in avalanche =  $t_{av} \cdot f$   
 $Z_{thJC}(D, t_{av})$  = Transient thermal resistance, see Figures 13)

$$P_{D(ave)} = 1/2 ( 1.3 \cdot BV \cdot I_{av} ) = \Delta T / Z_{thJC}$$

$$I_{av} = 2\Delta T / [1.3 \cdot BV \cdot Z_{th}]$$

$$E_{AS(AR)} = P_{D(ave)} \cdot t_{av}$$

Fig 15. Maximum Avalanche Energy vs. Temperature

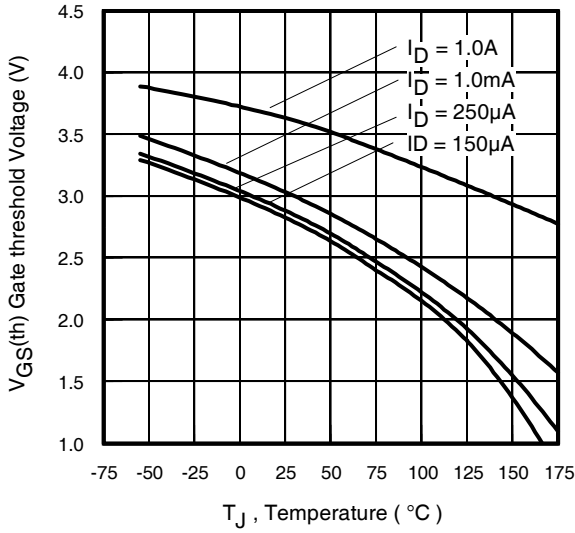

Fig 16. Threshold Voltage Vs. Temperature

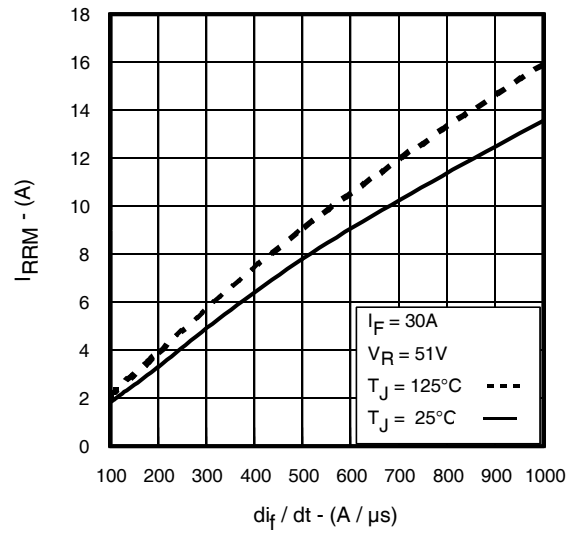

Fig. 17 - Typical Recovery Current vs.  $di_f/dt$

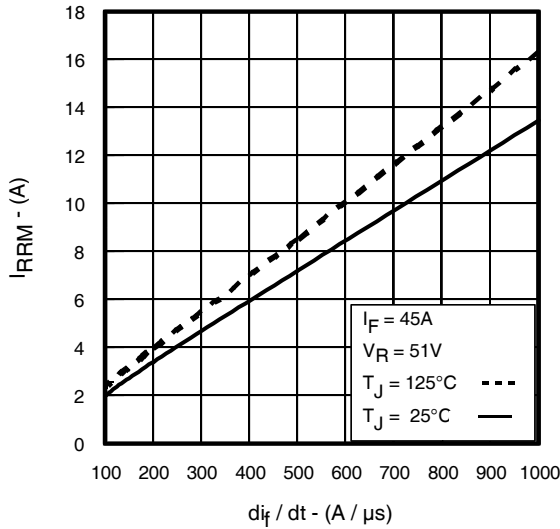

Fig. 18 - Typical Recovery Current vs.  $di_f/dt$

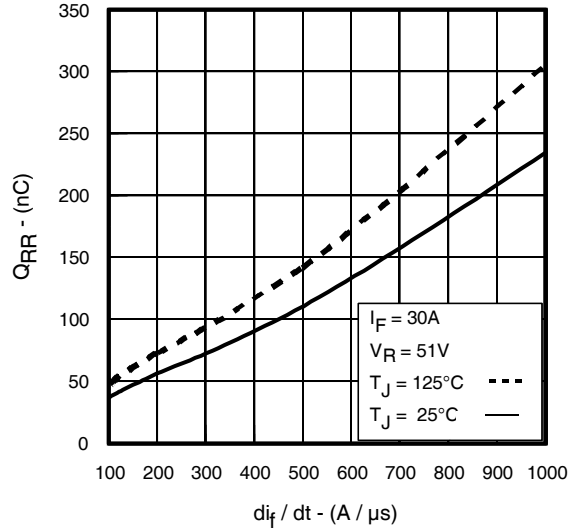

Fig. 19 - Typical Stored Charge vs.  $di_f/dt$

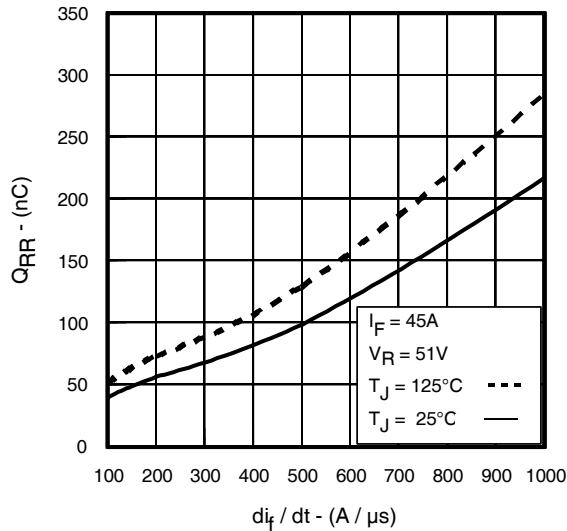
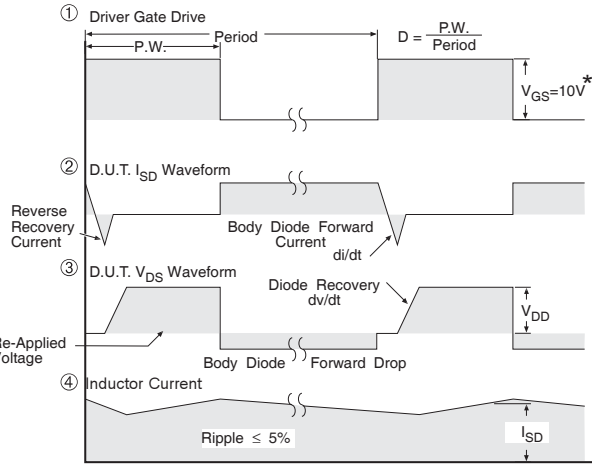

Fig. 20 - Typical Stored Charge vs.  $di_f/dt$



\*  $V_{GS} = 5V$  for Logic Level Devices

**Fig 21. Peak Diode Recovery dv/dt Test Circuit for N-Channel HEXFET® Power MOSFETs**



**Fig 22a. Unclamped Inductive Test Circuit**

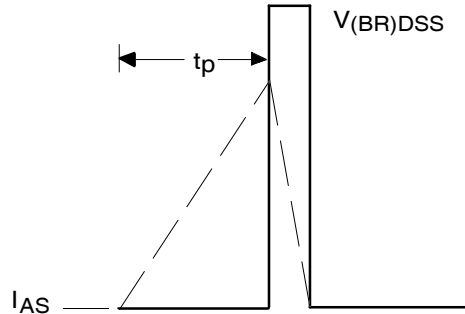

**Fig 22b. Unclamped Inductive Waveforms**

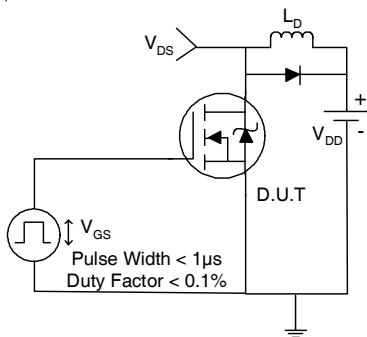

**Fig 23a. Switching Time Test Circuit**

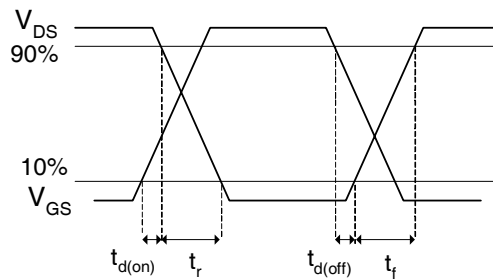

**Fig 23b. Switching Time Waveforms**

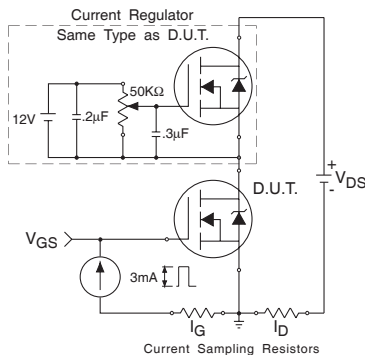

**Fig 24a. Gate Charge Test Circuit**

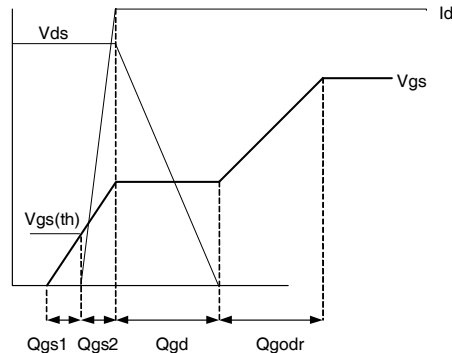

**Fig 24b. Gate Charge Waveform**

TO-220AB Package Outline

Dimensions are shown in millimeters (inches)

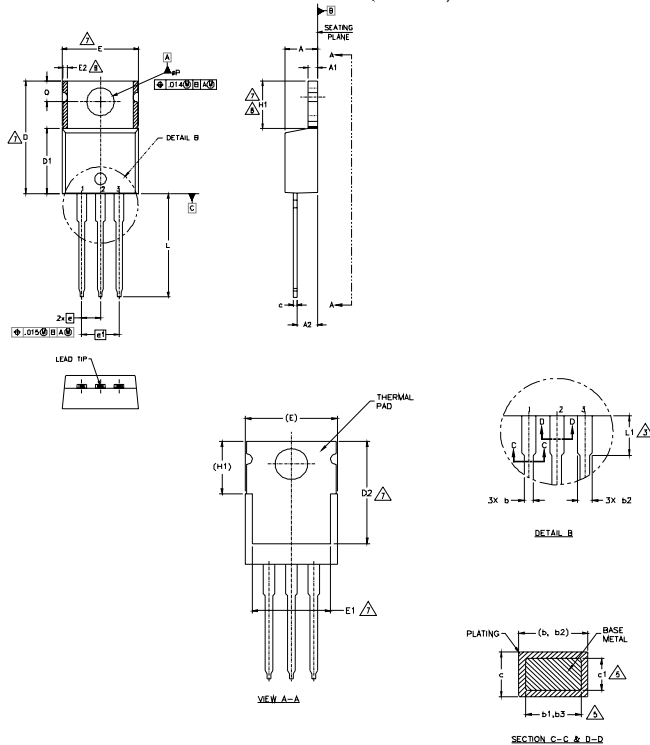

- NOTES:
- 1.- DIMENSIONING AND TOLERANCING AS PER ASME Y14.5 M- 1994.
  - 2.- DIMENSIONS ARE SHOWN IN INCHES [MILLIMETERS].
  - 3.- LEAD DIMENSION AND FINISH UNCONTROLLED IN L1.
  - 4.- DIMENSION D, D1 & E DO NOT INCLUDE MOLD FLASH. MOLD FLASH SHALL NOT EXCEED .005" (0.127) PER SIDE. THESE DIMENSIONS ARE MEASURED AT THE OUTERMOST EXTREMES OF THE PLASTIC BODY.
  - 5.- DIMENSION b1, b3 & c1 APPLY TO BASE METAL ONLY.
  - 6.- CONTROLLING DIMENSION : INCHES.
  - 7.- THERMAL PAD CONTOUR OPTIONAL WITHIN DIMENSIONS E,H1,D2 & E1
  - 8.- DIMENSION E2 X H1 DEFINE A ZONE WHERE STAMPING AND SINGULATION IRREGULARITIES ARE ALLOWED.
  - 9.- OUTLINE CONFORMS TO JEDEC TO-220, EXCEPT A2 (max) AND D2 (min.) WHERE DIMENSIONS ARE DERIVED FROM THE ACTUAL PACKAGE OUTLINE.

SYMBOL	DIMENSIONS				NOTES
	MILLIMETERS		INCHES		
	MIN.	MAX.	MIN.	MAX.	
A	3.56	4.83	.140	.190	
A1	0.51	1.40	.020	.055	
A2	2.03	2.92	.080	.115	
b	0.38	1.01	.015	.040	
b1	0.38	0.97	.015	.038	5
b2	1.14	1.78	.045	.070	
b3	1.14	1.73	.045	.068	5
c	0.36	0.61	.014	.024	
c1	0.36	0.56	.014	.022	5
D	14.22	16.51	.560	.650	4
D1	8.38	9.02	.330	.355	
D2	11.68	12.88	.460	.507	7
E	9.65	10.67	.380	.420	4,7
E1	6.86	8.89	.270	.350	7
E2	-	0.76	-	.030	8
e	2.54 BSC		.100 BSC		
e1	5.08 BSC		.200 BSC		
H1	5.84	6.86	.230	.270	7,8
L	12.70	14.73	.500	.580	
L1	3.56	4.06	.140	.160	3
øP	3.54	4.08	.139	.161	
Q	2.54	3.42	.100	.135	

- LEAD ASSIGNMENTS
- HEXFET
- 1.- GATE
  - 2.- DRAIN
  - 3.- SOURCE
- IGBTs, CoPACK
- 1.- GATE
  - 2.- COLLECTOR
  - 3.- EMITTER
- DIODES
- 1.- ANODE
  - 2.- CATHODE
  - 3.- ANODE

TO-220AB Part Marking Information

EXAMPLE: THIS IS AN IRFB4310GPBF

Note: "G" suffix in part number indicates "Halogen - Free"

Note: "P" in assembly line position indicates "Lead - Free"

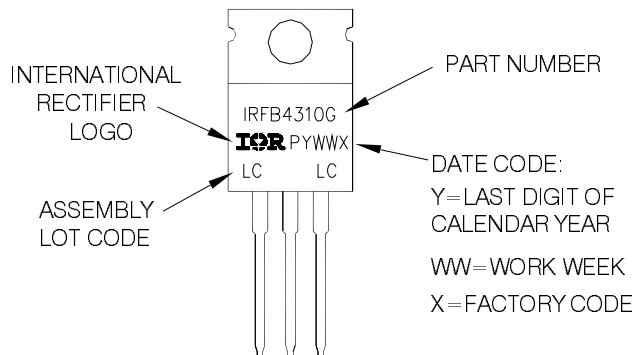

TO-220AB packages are not recommended for Surface Mount Application.

Note: For the most current drawing please refer to IR website at: <http://www.irf.com/package/>

Data and specifications subject to change without notice.  
This product has been designed and qualified for the Industrial market.  
Qualification Standards can be found on IR's Web site.

## Looking for pricing, stock, or lifecycle information?

Click below to explore more details on WIN SOURCE:

- ⊖ [View IRFB3206GPBF on WIN SOURCE](#)
- ⊖ [Infineon Technologies](#) Information

## Optimize Your Supply Chain with WIN SOURCE Solutions

- ✓ Global Sourcing Solution
- ✓ Obsolete Management
- ✓ Cost Control Management
- ✓ Shortage Management
- ✓ Alternative Solution
- ✓ Excess Inventory Management