



**THE DATASHEET OF
IRFI4410ZPBF**



HEXFET® Power MOSFET

Applications

- High Efficiency Synchronous Rectification in SMPS
- Uninterruptible Power Supply
- High Speed Power Switching
- Hard Switched and High Frequency Circuits

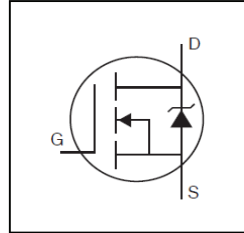

| | |
|--------------------------------|--------------|
| V_{DSS} | 100V |
| R_{DS(on)} typ. | 7.9mΩ |
| R_{DS(on)} max. | 9.3mΩ |
| I_D | 43A |

Benefits

- Improved Gate, Avalanche and Dynamic dV/dt Ruggedness
- Fully Characterized Capacitance and Avalanche SOA
- Enhanced body diode dV/dt and dI/dt Capability
- Lead-Free

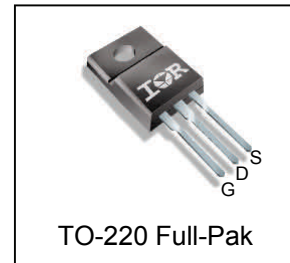

TO-220 Full-Pak

| | | |
|----------|----------|----------|
| G | D | S |
| Gate | Drain | Source |

| Base Part Number | Package Type | Standard Pack | | Orderable Part Number |
|------------------|-----------------|---------------|----------|-----------------------|
| | | Form | Quantity | |
| IRFI4410ZPbF | TO-220 Full-Pak | Tube | 50 | IRFI4410ZPbF |

Absolute Maximum Ratings

| Symbol | Parameter | Max. | Units |
|-----------------------------------------|---------------------------------------------------------|--------------------|-------|
| I _D @ T _C = 25°C | Continuous Drain Current, V _{GS} @ 10V | 43 | A |
| I _D @ T _C = 100°C | Continuous Drain Current, V _{GS} @ 10V | 30 | |
| I _{DM} | Pulsed Drain Current ① | 170 | |
| P _D @ T _C = 25°C | Maximum Power Dissipation | 47 | W |
| | Linear Derating Factor | 0.3 | W/°C |
| V _{GS} | Gate-to-Source Voltage | ± 30 | V |
| E _{AS} | Single Pulse Avalanche Energy (Thermally Limited) ② | 310 | mJ |
| T _J | Operating Junction and | -55 to + 175 | °C |
| T _{STG} | Storage Temperature Range | | |
| | Soldering Temperature, for 10 seconds (1.6mm from case) | | |
| | Mounting torque, 6-32 or M3 screw | 10 lbf•in (1.1N•m) | |

Thermal Resistance

| Symbol | Parameter | Typ. | Max. | Units |
|------------------|----------------------------------|------|------|-------|
| R _{θJC} | Junction-to-Case ④ | — | 3.2 | °C/W |
| R _{θJA} | Junction-to-Ambient (PCB Mount)④ | — | 65 | |

Electrical Characteristics @ T_J = 25°C (unless otherwise specified)

| | Parameter | Min. | Typ. | Max. | Units | Conditions |
|----------------------------------------|--------------------------------------|------|------|------|-------|----------------------------------------------------------------------|
| V _{(BR)DSS} | Drain-to-Source Breakdown Voltage | 100 | — | — | V | V _{GS} = 0V, I _D = 250μA |
| ΔV _{(BR)DSS} /ΔT _J | Breakdown Voltage Temp. Coefficient | — | 95 | — | mV/°C | Reference to 25°C, I _D = 5mA ① |
| R _{DS(on)} | Static Drain-to-Source On-Resistance | — | 7.9 | 9.3 | mΩ | V _{GS} = 10V, I _D = 26A |
| V _{GS(th)} | Gate Threshold Voltage | 2.0 | — | 4.0 | V | V _{DS} = V _{GS} , I _D = 150μA |
| I _{DSS} | Drain-to-Source Leakage Current | — | — | 20 | μA | V _{DS} = 100V, V _{GS} = 0V |
| | | — | — | 250 | | V _{DS} = 100V, V _{GS} = 0V, T _J = 125°C |
| I _{GSS} | Gate-to-Source Forward Leakage | — | — | 100 | nA | V _{GS} = 20V |
| | Gate-to-Source Reverse Leakage | — | — | -100 | | V _{GS} = -20V |
| R _G | Internal Gate Resistance | — | 0.9 | — | Ω | |

Dynamic @ T_J = 25°C (unless otherwise specified)

| | | | | | | |
|----------------------------|-----------------------------------------------|----|------|-----|----|-----------------------------------------------------------------|
| g _{fs} | Forward Trans conductance | 80 | — | — | S | V _{DS} = 50V, I _D = 26A |
| Q _g | Total Gate Charge | — | 81 | 110 | nC | I _D = 26A |
| Q _{gs} | Gate-to-Source Charge | — | 18 | — | | V _{DS} = 50V |
| Q _{gd} | Gate-to-Drain Charge | — | 23 | — | | V _{GS} = 10V ④ |
| t _{d(on)} | Turn-On Delay Time | — | 15 | — | ns | V _{DD} = 65V |
| t _r | Rise Time | — | 27 | — | | I _D = 26A |
| t _{d(off)} | Turn-Off Delay Time | — | 43 | — | | R _G = 2.7Ω |
| t _f | Fall Time | — | 30 | — | | V _{GS} = 10V ④ |
| C _{iss} | Input Capacitance | — | 4910 | — | pF | V _{GS} = 0V |
| C _{oss} | Output Capacitance | — | 330 | — | | V _{DS} = 50V |
| C _{rss} | Reverse Transfer Capacitance | — | 150 | — | | f = 1.0MHz |
| C _{oss eff. (ER)} | Effective Output Capacitance (Energy Related) | — | 420 | — | | V _{GS} = 0V, V _{DS} = 0V to 80V ⑥ See Fig. 11 |
| C _{oss eff. (TR)} | Effective Output Capacitance (Time Related) | — | 680 | — | | V _{GS} = 0V, V _{DS} = 0V to 80V ⑤ |

Source-Drain Ratings and Characteristics

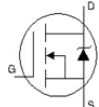
| | Parameter | Min. | Typ. | Max. | Units | Conditions |
|------------------|----------------------------------------|------------------------------------------------------------------------------------------------|------|------|-------|------------------------------------------------------------------------------------------------------------------------------------------------------|
| I _S | Continuous Source Current (Body Diode) | — | — | 43 | A | MOSFET symbol showing the integral reverse p-n junction diode.  |
| I _{SM} | Pulsed Source Current (Body Diode) ① | — | — | 170 | | |
| V _{SD} | Diode Forward Voltage | — | — | 1.3 | V | T _J = 25°C, I _S = 26A, V _{GS} = 0V ④ |
| t _{rr} | Reverse Recovery Time | — | 47 | 71 | ns | T _J = 25°C |
| | | — | 54 | 81 | | T _J = 125°C |
| Q _{rr} | Reverse Recovery Charge | — | 110 | 160 | nC | T _J = 25°C — V _R = 85V |
| | | — | 140 | 210 | | T _J = 125°C — I _F = 26A |
| I _{RRM} | Reverse Recovery Current | — | 2.5 | — | A | T _J = 25°C — di/dt = 100A/μs ④ |
| t _{on} | Forward Turn-On Time | Intrinsic turn-on time is negligible (turn-on is dominated by L _S +L _D) | | | | |

Notes:

- ① Repetitive rating; pulse width limited by max. junction temperature. (See fig. 11)
- ② Limited by T_{Jmax}, starting T_J = 25°C, L = 0.91mH, R_G = 25Ω, I_{AS} = 26A, V_{GS} = 10V. Part not recommended for use above this value.
- ③ Pulse width ≤ 400μs; duty cycle ≤ 2%.
- ④ R_θ is measured at T_J approximately 90°C.
- ⑤ C_{oss eff. (TR)} is a fixed capacitance that gives the same charging time as C_{oss} while V_{DS} is rising from 0 to 80% V_{DSS}.
- ⑥ C_{oss eff. (ER)} is a fixed capacitance that gives the same energy as C_{oss} while V_{DS} is rising from 0 to 80% V_{DSS}.

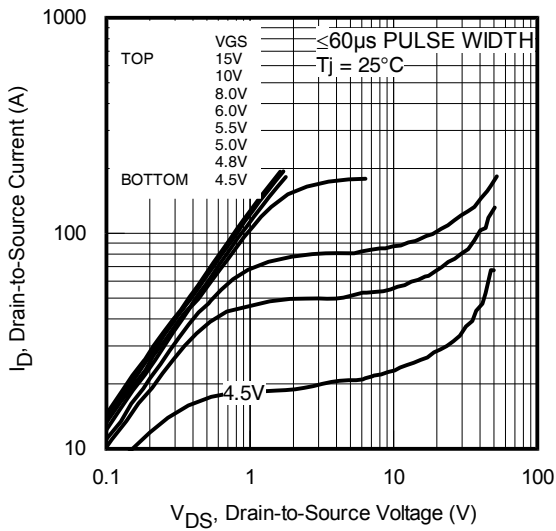
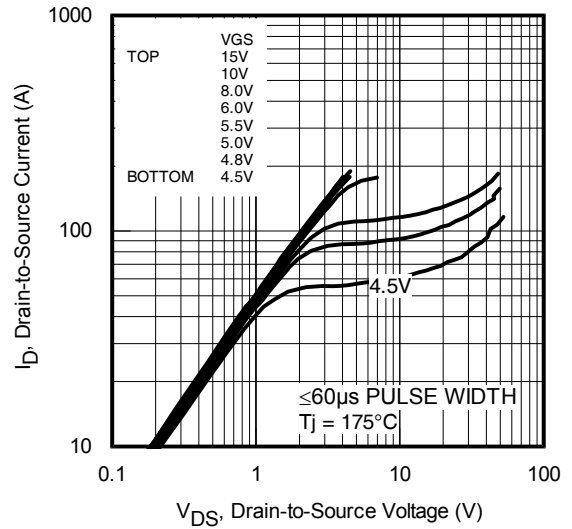
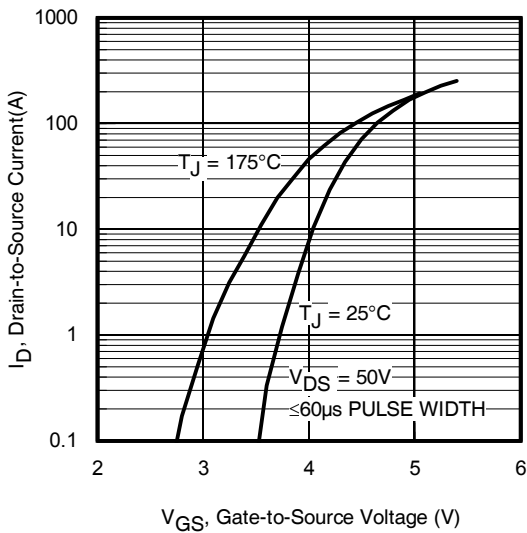
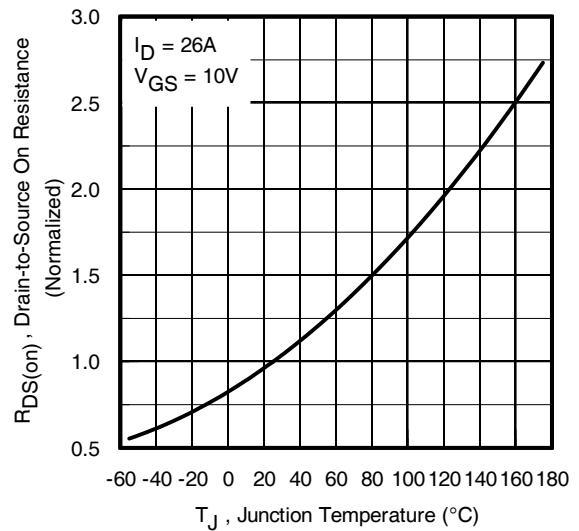
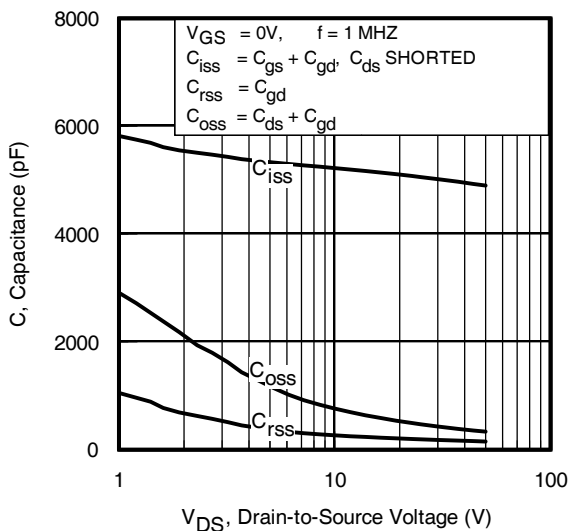
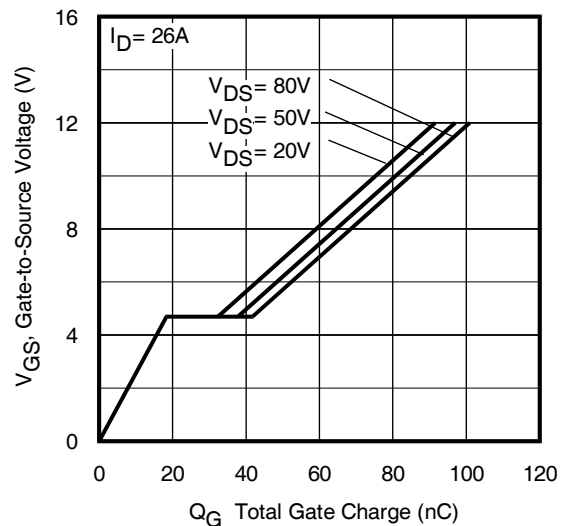
Fig. 1 Typical Output Characteristics

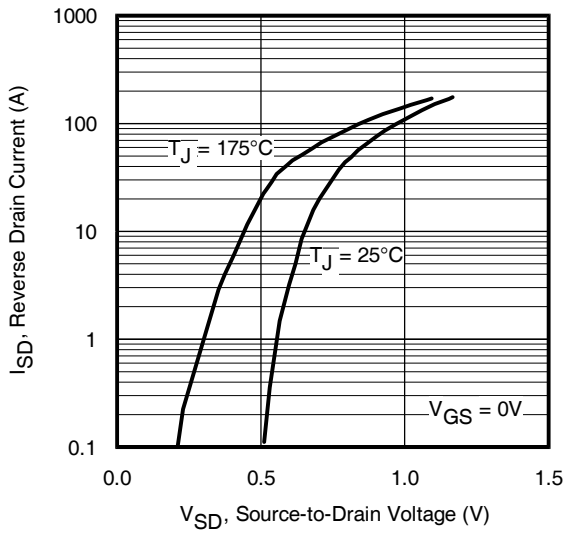
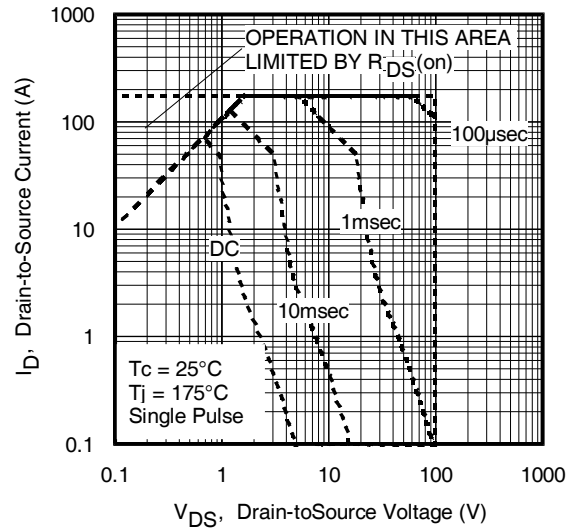
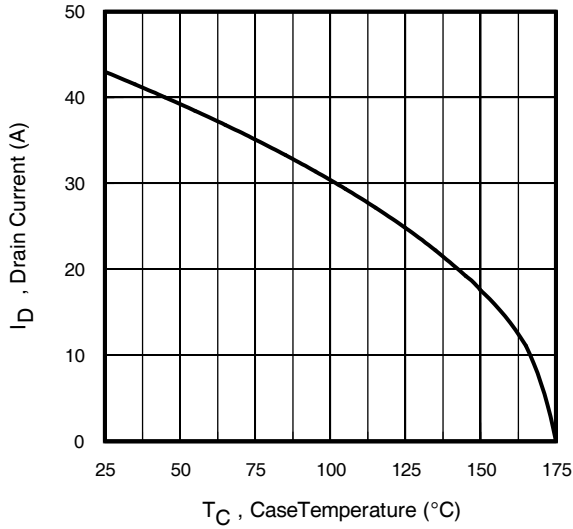
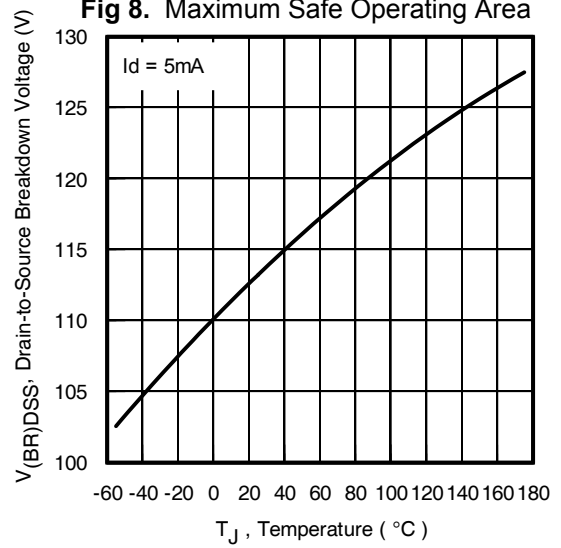
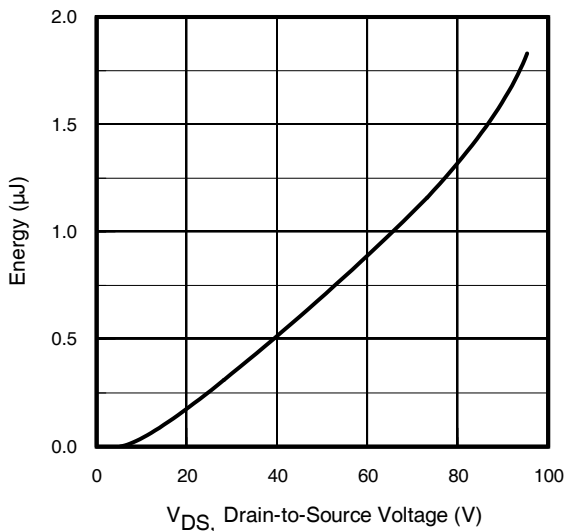
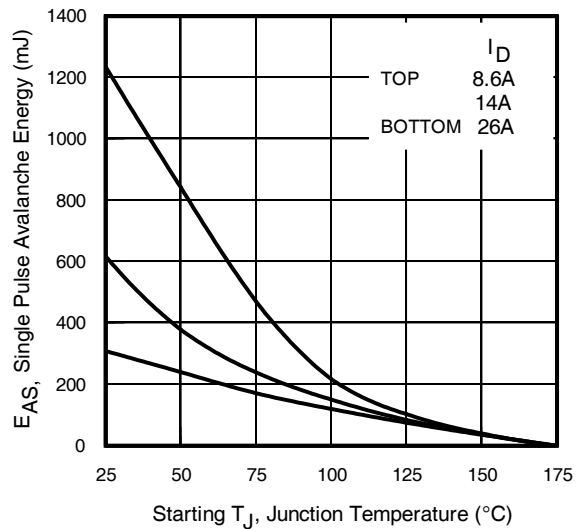
Fig. 2 Typical Output Characteristics

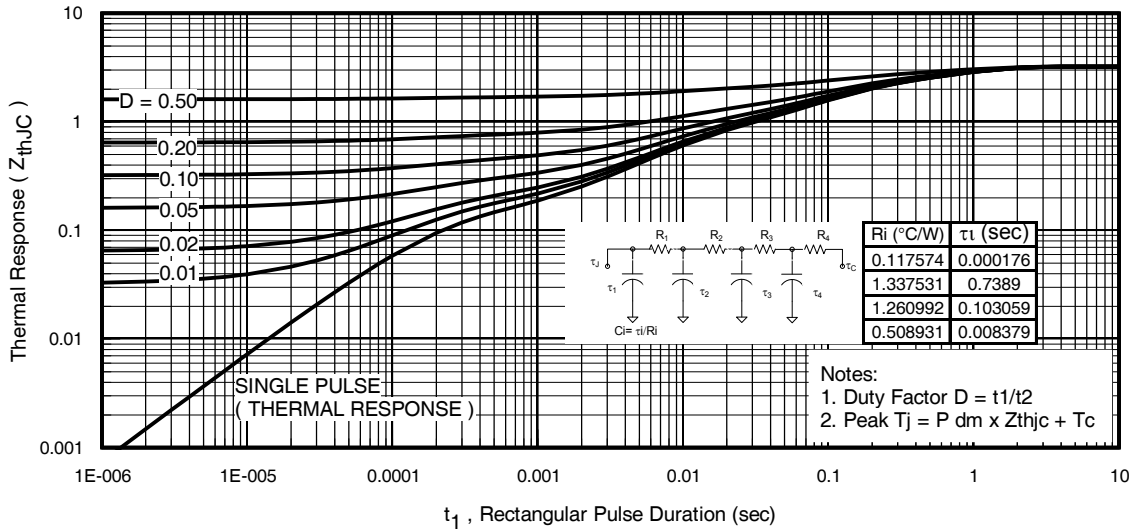
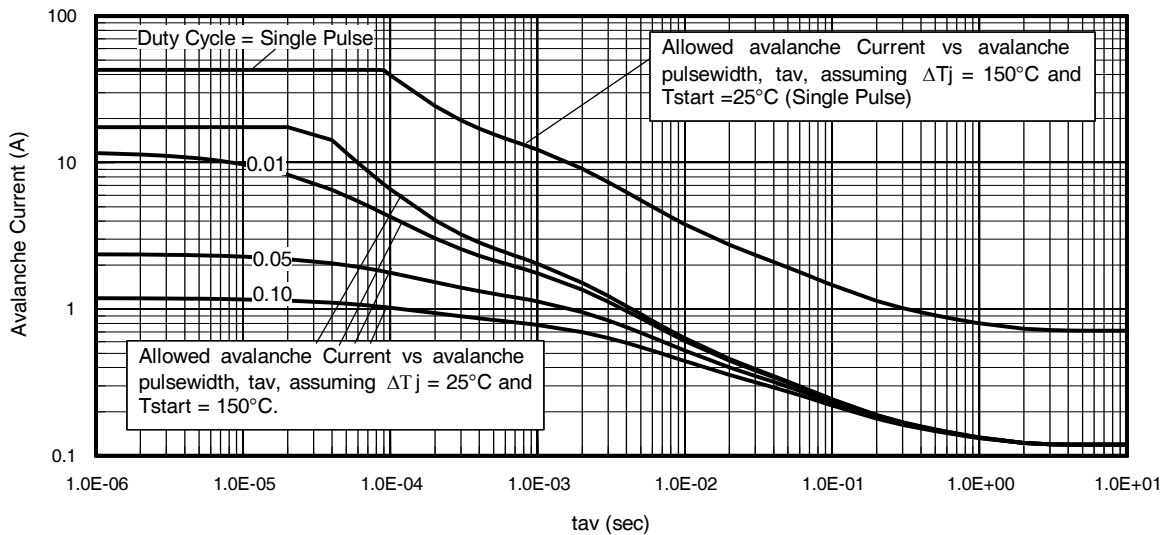
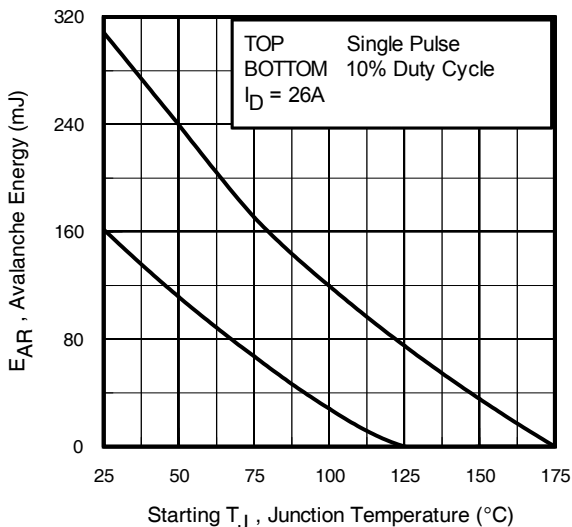
Fig. 3 Typical Transfer Characteristics

Fig. 4 Normalized On-Resistance vs. Temperature

Fig. 5. Typical Capacitance vs. Drain-to-Source Voltage

Fig. 6. Typical Gate Charge vs. Gate-to-Source Voltage

Fig. 7. Typical Source-to-Drain Diode Forward Voltage

Fig 8. Maximum Safe Operating Area

Fig. 9. Maximum Drain Current vs. Case Temperature

Fig 10. Drain-to-Source Breakdown Voltage

Fig. 11. Typical C_{OSS} Stored Energy

Fig 12. Maximum Avalanche Energy vs. Drain Current

Fig 13. Maximum Effective Transient Thermal Impedance, Junction-to-Case

Fig 14. Single Avalanche Event: Pulse Current vs. Pulse Width

Notes on Repetitive Avalanche Curves , Figures 14, 15:
(For further info, see AN-1005 at www.infineon.com)

1. Avalanche failures assumption:
Purely a thermal phenomenon and failure occurs at a temperature far in excess of T_{jmax} . This is validated for every part type.
2. Safe operation in Avalanche is allowed as long as T_{jmax} is not exceeded.
3. Equation below based on circuit and waveforms shown in Figures 16a, 16b.
4. $P_{D(ave)}$ = Average power dissipation per single avalanche pulse.
5. BV = Rated breakdown voltage (1.3 factor accounts for voltage increase during avalanche).
6. I_{av} = Allowable avalanche current.
7. ΔT = Allowable rise in junction temperature, not to exceed T_{jmax} (assumed as 25°C in Figure 14, 15).
 t_{av} = Average time in avalanche.
 D = Duty cycle in avalanche = $t_{av} \cdot f$
 $Z_{thJC}(D, t_{av})$ = Transient thermal resistance, see Figures 13)

$$P_{D(ave)} = 1/2 (1.3 \cdot BV \cdot I_{av}) = \Delta T / Z_{thJC}$$

$$I_{av} = 2\Delta T / [1.3 \cdot BV \cdot Z_{th}]$$

$$E_{AS(AR)} = P_{D(ave)} \cdot t_{av}$$

Fig 15. Maximum Avalanche Energy vs. Temperature

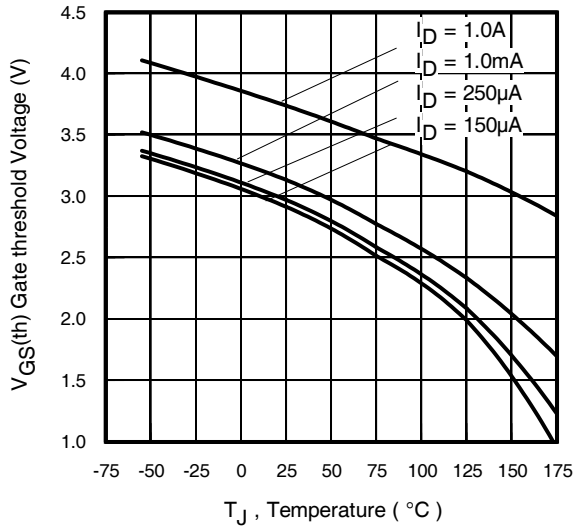
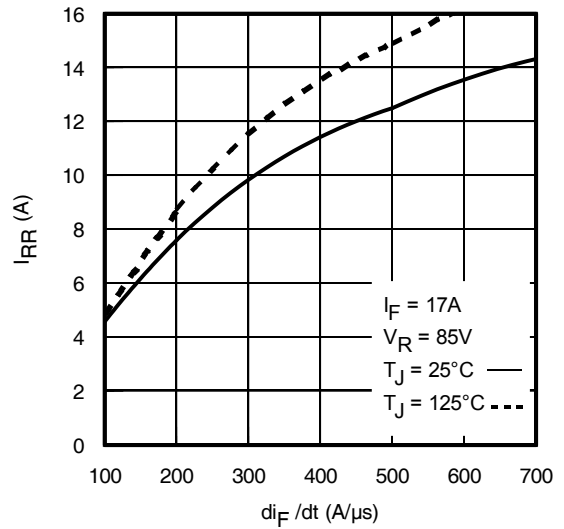
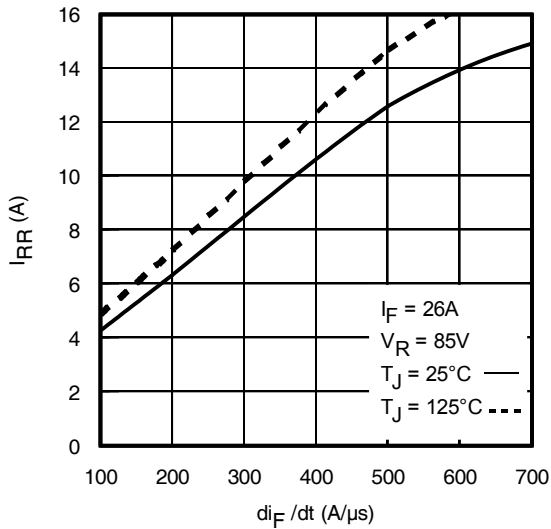
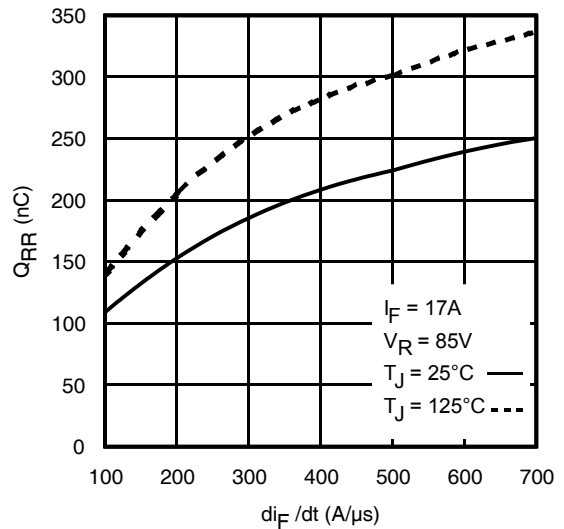
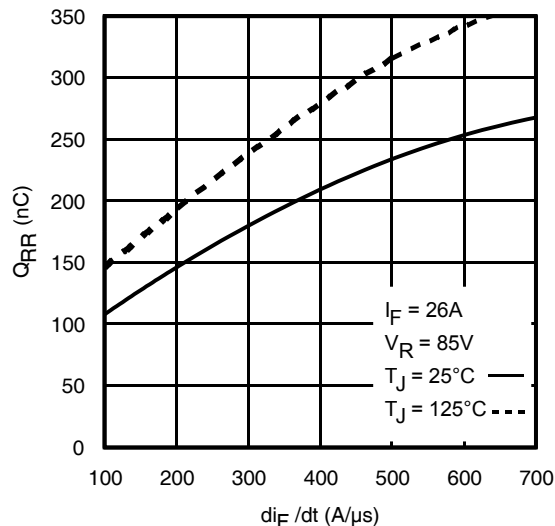
Fig 16. Threshold Voltage vs. Temperature

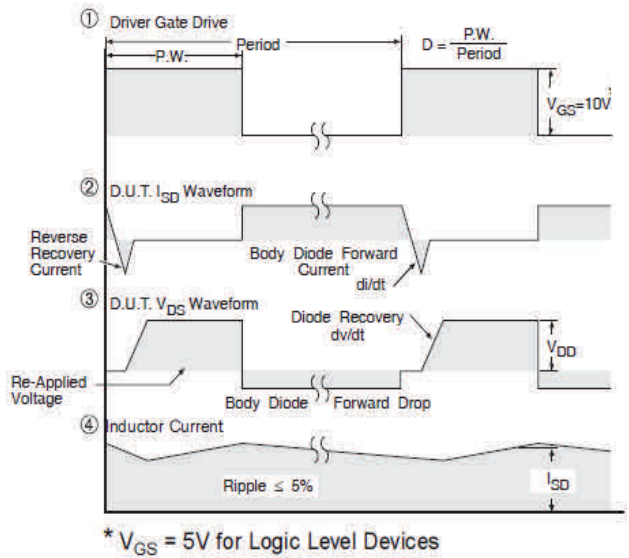
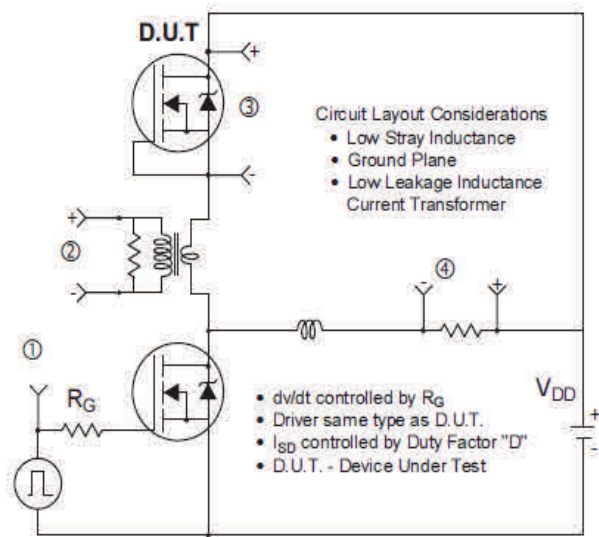
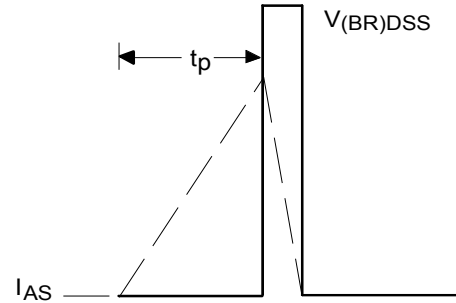
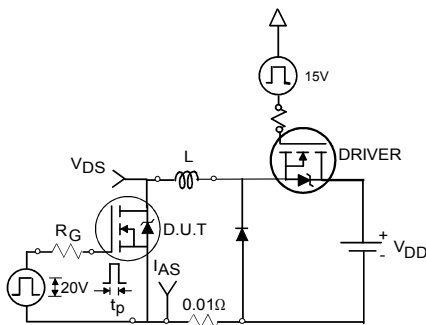
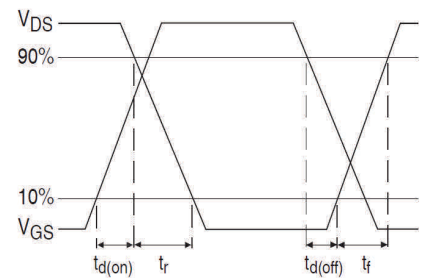
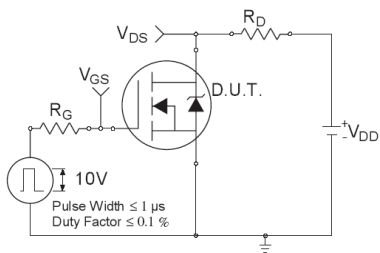
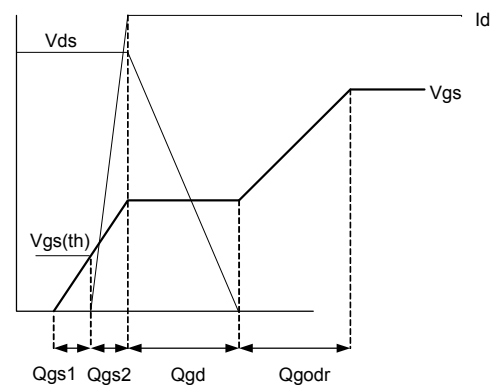
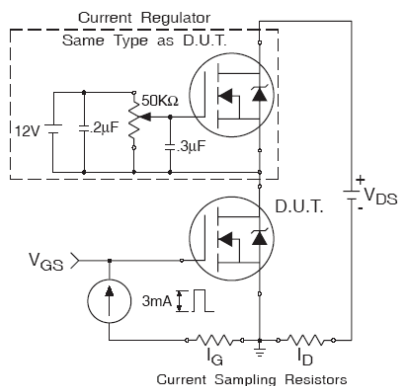
Fig 17. Typical Recovery Current vs. di_F/dt

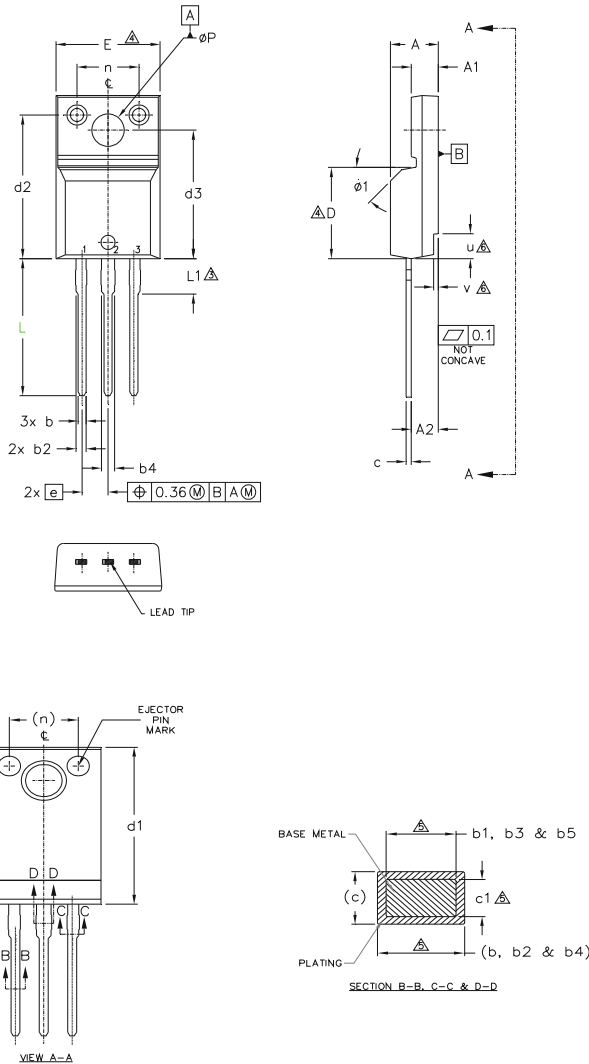
Fig 18. Typical Recovery Current vs. di_F/dt

Fig 19. Typical Stored Charge vs. di_F/dt

Fig 20. Typical Stored Charge vs. di_F/dt

Fig 21. Peak Diode Recovery dv/dt Test Circuit for N-Channel HEXFET[®] Power MOSFETs

Fig 22a. Unclamped Inductive Test Circuit
Fig 22b. Unclamped Inductive Waveforms

Fig 23a. Switching Time Test Circuit
Fig 23b. Switching Time Waveforms

Fig 24a. Gate Charge Test Circuit
Fig 24b. Gate Charge Waveform

TO-220 Full-Pak Package Outline (Dimensions are shown in millimeters (inches))

NOTES:

- 1.0 DIMENSIONING AND TOLERANCING AS PER ASME Y14.5 M- 1994.
- 2.0 DIMENSIONS ARE SHOWN IN MILLIMETERS [INCHES].
- 3.0 LEAD DIMENSION AND FINISH UNCONTROLLED IN L1.
- 4.0 DIMENSION D & E DO NOT INCLUDE MOLD FLASH. MOLD FLASH SHALL NOT EXCEED .005" (0.127) PER SIDE. THESE DIMENSIONS ARE MEASURED AT THE OUTER MOST EXTREMES OF THE PLASTIC BODY.
- 5.0 DIMENSION b1, b3, b5 & c1 APPLY TO BASE METAL ONLY.
- 6.0 STEP OPTIONAL ON PLASTIC BODY DEFINED BY DIMENSIONS u & v.
- 7.0 CONTROLLING DIMENSION : INCHES.

| SYMBOL | DIMENSIONS | | | | NOTES | |
|--------|-------------|-------|----------|------|----------------------------------------------------------------------------------------------------------------------------------------|---|
| | MILLIMETERS | | INCHES | | | |
| | MIN. | MAX. | MIN. | MAX. | | |
| A | 4.57 | 4.83 | .180 | .190 | LEAD ASSIGNMENTS HEXFET 1.- GATE 2.- DRAIN 3.- SOURCE IGBTs, CoPACK 1.- GATE 2.- COLLECTOR 3.- EMITTER | |
| A1 | 2.57 | 2.82 | .101 | .111 | | |
| A2 | 2.51 | 2.92 | .099 | .115 | | |
| b | 0.61 | 0.94 | .024 | .037 | | |
| b1 | 0.61 | 0.89 | .024 | .035 | | 5 |
| b2 | 0.76 | 1.27 | .030 | .050 | | |
| b3 | 0.76 | 1.22 | .030 | .048 | | 5 |
| b4 | 1.02 | 1.52 | .040 | .060 | | 5 |
| b5 | 1.02 | 1.47 | .040 | .058 | | 5 |
| c | 0.33 | 0.63 | .013 | .025 | | |
| c1 | 0.33 | 0.58 | .013 | .023 | | 5 |
| D | 8.66 | 9.80 | .341 | .386 | | 4 |
| d1 | 15.80 | 16.13 | .622 | .635 | | |
| d2 | 13.97 | 14.22 | .550 | .560 | | |
| d3 | 12.29 | 12.93 | .484 | .509 | | |
| E | 9.63 | 10.74 | .379 | .423 | 4 | |
| e | 2.54 BSC | | .100 BSC | | | |
| L | 13.21 | 13.72 | .520 | .540 | 3 | |
| L1 | 3.10 | 3.68 | .122 | .145 | | |
| n | 6.05 | 6.60 | .238 | .260 | | |
| phi P | 3.05 | 3.45 | .120 | .136 | 6 | |
| u | 2.39 | 2.49 | .094 | .098 | 6 | |
| v | 0.41 | 0.51 | .016 | .020 | | |
| phi 1 | - | 45° | - | 45° | | |

TO-220 Full-Pak Part Marking Information

EXAMPLE: THIS IS AN IRFI840G
WITH ASSEMBLY
LOT CODE 3432
ASSEMBLED ON WW 24, 2001
IN THE ASSEMBLY LINE "K"

Note: "P" in assembly line position
indicates "Lead-Free"

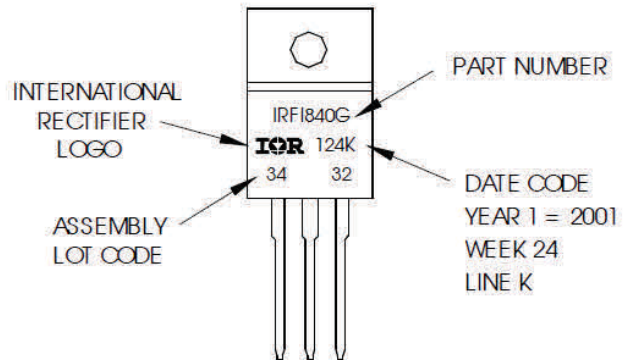

TO-220AB Full-Pak packages are not recommended for Surface Mount Application.

Note: For the most current drawing please refer to website at <http://www.irf.com/package/>

Qualification Information

| | | |
|-----------------------------------|-------------------------------------|-----|
| Qualification Level | Industrial (per JEDEC JESD47F) † | |
| Moisture Sensitivity Level | TO-220 Full-Pak | N/A |
| RoHS Compliant | Yes | |

† Applicable version of JEDEC standard at the time of product release.

Revision History

| Date | Comments |
|------------|------------------------------------------------------------------------------------------------------------------------------------------------------------------------------------------------------------------------------------------------------------------------|
| 04/27/2017 | <ul style="list-style-type: none"> Changed datasheet with Infineon logo - all pages. Corrected Package Outline on page 8. Corrected fig 19 & 20 –Y axis title from “A” to “nC” on page 6. Added disclaimer on last page. |

Trademarks of Infineon Technologies AG

µHVIC™, µIPM™, µPFC™, AU-ConvertIR™, AURIX™, C166™, CanPAK™, CIPOS™, CIPURSE™, CoolDP™, CoolGaN™, COOLiR™, CoolMOST™, CoolSET™, CoolSiC™, DAVE™, DI-POL™, DirectFET™, DrBlade™, EasyPIM™, EconoBRIDGE™, EconoDUAL™, EconoPACK™, EconoPIM™, EiceDRIVER™, eupec™, FCOS™, GaNpowIR™, HEXFET™, HITFET™, HybridPACK™, iMOTION™, IRAM™, ISOFACE™, IsoPACK™, LEDrivIR™, LITIX™, MIPAQ™, ModSTACK™, my-d™, NovalithIC™, OPTIGA™, OptiMOST™, ORIGA™, PowIRaudio™, PowIRstage™, PrimePACK™, PrimeSTACK™, PROFET™, PRO-SiL™, RASiC™, REAL3™, SmartLEWIS™, SOLID FLASH™, SPOC™, StrongIRFET™, SupIRBuck™, TEMPFET™, TRENCHSTOP™, TriCore™, UHVIC™, XHP™, XMC™

Trademarks updated November 2015

Other Trademarks

All referenced product or service names and trademarks are the property of their respective owners.

Edition 2016-04-19

Published by
Infineon Technologies AG
81726 Munich, Germany

© 2016 Infineon Technologies AG.
All Rights Reserved.

Do you have a question about this document?
Email: erratum@infineon.com

Document reference
ifx1

IMPORTANT NOTICE

The information given in this document shall in no event be regarded as a guarantee of conditions or **characteristics (“Beschaffenheitsgarantie”)**.

With respect to any examples, hints or any typical values stated herein and/or any information regarding the application of the product, Infineon Technologies hereby disclaims any and all warranties and liabilities of any kind, including without limitation warranties of non-infringement of intellectual property rights of any third party.

In addition, any information given in this document **is subject to customer’s compliance with its obligations** stated in this document and any applicable legal requirements, norms and standards concerning customer’s products and any use of the product of Infineon Technologies in **customer’s applications**.

The data contained in this document is exclusively intended for technically trained staff. It is the **responsibility of customer’s technical departments** to evaluate the suitability of the product for the intended application and the completeness of the product information given in this document with respect to such application.

For further information on the product, technology, delivery terms and conditions and prices please contact your nearest Infineon Technologies office (www.infineon.com).

Please note that this product is not qualified according to the AEC Q100 or AEC Q101 documents of the Automotive Electronics Council.

WARNINGS

Due to technical requirements products may contain dangerous substances. For information on the types in question please contact your nearest Infineon Technologies office.

Except as otherwise explicitly approved by Infineon Technologies in a written document signed by authorized representatives of Infineon Technologies, **Infineon Technologies’ products may not be used** in any applications where a failure of the product or any consequences of the use thereof can reasonably be expected to result in personal injury.

Looking for pricing, stock, or lifecycle information?

Click below to explore more details on WIN SOURCE:

 [View IRFI4410ZPBF on WIN SOURCE](#)

 [Infineon Technologies](#) Information

Optimize Your Supply Chain with WIN SOURCE Solutions

-  Global Sourcing Solution
-  Obsolete Management
-  Cost Control Management
-  Shortage Management
-  Alternative Solution
-  Excess Inventory Management