



THE DATASHEET OF IRFP260MPBF



Features

- Advanced Process Technology
- Dynamic dv/dt Rating
- 175°C Operating Temperature
- Fast Switching
- Fully Avalanche Rated
- Ease of Paralleling
- Simple Drive Requirements
- Lead-Free

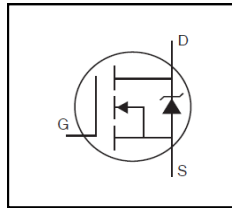

| | |
|-------------------|--------------|
| $V_{(BR)DSS}$ | 200V |
| $R_{DS(on)}$ max. | 0.04Ω |
| I_D | 50A |

Description

IR MOSFET™ technology from Infineon utilizes advanced processing techniques to achieve extremely low on-resistance per silicon area. This benefit, combined with the fast switching speed and rugged device design that IR MOSFET™ devices are well known for, provides the designer with an extremely efficient and reliable device for use in a wide variety of applications.

The TO-247 package is preferred for commercial-industrial applications where higher power levels preclude the use of TO-220 devices. The TO-247 is similar but superior to the earlier TO-218 package because of its isolated mounting hole.

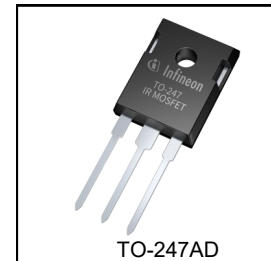

| | | |
|----------|----------|----------|
| G | D | S |
| Gate | Drain | Source |

| Base part number | Package Type | Standard Pack | | Orderable Part Number |
|------------------|--------------|---------------|----------|-----------------------|
| | | Form | Quantity | |
| IRFP260MPbF | TO-247AD | Tube | 25 | IRFP260MPbF |

Absolute Maximum Ratings

| Symbol | Parameter | Max. | Units |
|---------------------------------|---|--------------------|-------|
| $I_D @ T_C = 25^\circ\text{C}$ | Continuous Drain Current, $V_{GS} @ 10\text{V}$ | 50 | A |
| $I_D @ T_C = 100^\circ\text{C}$ | Continuous Drain Current, $V_{GS} @ 10\text{V}$ | 35 | |
| I_{DM} | Pulsed Drain Current ①⑤ | 200 | |
| $P_D @ T_C = 25^\circ\text{C}$ | Maximum Power Dissipation | 300 | W |
| | Linear Derating Factor | 2.0 | W/°C |
| V_{GS} | Gate-to-Source Voltage | ± 20 | V |
| E_{AS} | Single Pulse Avalanche Energy ②③ | 560 | mJ |
| I_{AR} | Avalanche Current ①⑤ | 50 | A |
| E_{AR} | Repetitive Avalanche Energy ① | 30 | mJ |
| dv/dt | Peak Diode Recovery dv/dt③⑤ | 10 | V/ns |
| T_J T_{STG} | Operating Junction and Storage Temperature Range | -55 to + 175 | °C |
| | Soldering Temperature, for 10 seconds (1.6mm from case) | 300 | |
| | Mounting torque, 6-32 or M3 screw | 10 lbf·in (1.1N·m) | |

Thermal Resistance

| Symbol | Parameter | Typ. | Max. | Units |
|-----------------|-------------------------------------|------|------|-------|
| $R_{\theta JC}$ | Junction-to-Case | — | 0.50 | °C/W |
| $R_{\theta CS}$ | Case-to-Sink, Flat, Greased Surface | 0.24 | — | |
| $R_{\theta JA}$ | Junction-to-Ambient | — | 40 | |

Electrical characteristics @ T_J = 25°C (unless otherwise specified)

| | Parameter | Min. | Typ. | Max. | Units | Conditions |
|--|--------------------------------------|------|------|------|-------|--|
| V _{(BR)DSS} | Drain-to-Source Breakdown Voltage | 200 | — | — | V | V _{GS} = 0V, I _D = 250μA |
| ΔV _{(BR)DSS} /ΔT _J | Breakdown Voltage Temp. Coefficient | — | 0.26 | — | V/°C | Reference to 25°C, I _D = 1mA |
| R _{DS(on)} | Static Drain-to-Source On-Resistance | — | — | 0.04 | Ω | V _{GS} = 10V, I _D = 28A ④ |
| V _{GS(th)} | Gate Threshold Voltage | 2.0 | — | 4.0 | V | V _{DS} = V _{GS} , I _D = 250μA |
| g _{fs} | Forward Trans conductance | 27 | — | — | S | V _{DS} = 50V, I _D = 28A④ |
| I _{DSS} | Drain-to-Source Leakage Current | — | — | 25 | μA | V _{DS} = 200V, V _{GS} = 0V |
| | | — | — | 250 | | V _{DS} = 160V, V _{GS} = 0V, T _J = 150°C |
| I _{GSS} | Gate-to-Source Forward Leakage | — | — | 100 | nA | V _{GS} = 20V |
| | Gate-to-Source Reverse Leakage | — | — | -100 | | V _{GS} = -20V |

Dynamic Electrical Characteristics @ T_J = 25°C (unless otherwise specified)

| | | | | | | |
|---------------------|------------------------------|---|------|-----|----|---|
| Q _g | Total Gate Charge | — | — | 234 | nC | I _D = 28A |
| Q _{gs} | Gate-to-Source Charge | — | — | 38 | | V _{DS} = 160V |
| Q _{gd} | Gate-to-Drain Charge | — | — | 110 | | V _{GS} = 10V, See Fig.6 and 13 ④ |
| t _{d(on)} | Turn-On Delay Time | — | 17 | — | ns | V _{DD} = 100V |
| t _r | Rise Time | — | 60 | — | | I _D = 28A |
| t _{d(off)} | Turn-Off Delay Time | — | 55 | — | | R _G = 1.8Ω |
| t _f | Fall Time | — | 48 | — | | V _{GS} = 10V, See Fig.10④ |
| L _D | Internal Drain Inductance | — | 5.0 | — | nH | Between lead, 6mm (0.25in.) from package and center of die contact |
| L _S | Internal Source Inductance | — | 13 | — | |  |
| C _{iss} | Input Capacitance | — | 4057 | — | pF | V _{GS} = 0V |
| C _{oss} | Output Capacitance | — | 603 | — | | V _{DS} = 25V |
| C _{rss} | Reverse Transfer Capacitance | — | 161 | — | | f = 1.0MHz, See Fig.5 |

Diode Characteristics

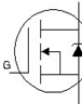
| | Parameter | Min. | Typ. | Max. | Units | Conditions |
|-----------------|--|------|------|------|-------|--|
| I _S | Continuous Source Current (Body Diode) | — | — | 50 | A | MOSFET symbol showing the integral reverse p-n junction diode.  |
| I _{SM} | Pulsed Source Current (Body Diode) ① | — | — | 200 | | |
| V _{SD} | Diode Forward Voltage | — | — | 1.3 | V | T _J = 25°C, I _S = 28A, V _{GS} = 0V ④ |
| t _{rr} | Reverse Recovery Time | — | 268 | 402 | ns | T _J = 25°C, I _F = 28A |
| Q _{rr} | Reverse Recovery Charge | — | 1.9 | 2.8 | μC | di/dt = 100A/μs ④ |

Notes:

- ① Repetitive rating; pulse width limited by max. junction temperature. (See fig. 11).
- ② Starting T_J = 25°C, L = 1.5mH, R_G = 25Ω, I_{AS} = 28A.(See fig. 12).
- ③ I_{SD} ≤ 28A, di/dt ≤ 486A/μs, V_{DD} ≤ V_{(BR)DSS}, T_J ≤ 175°C.
- ④ Pulse width ≤ 400μs; duty cycle ≤ 2%.

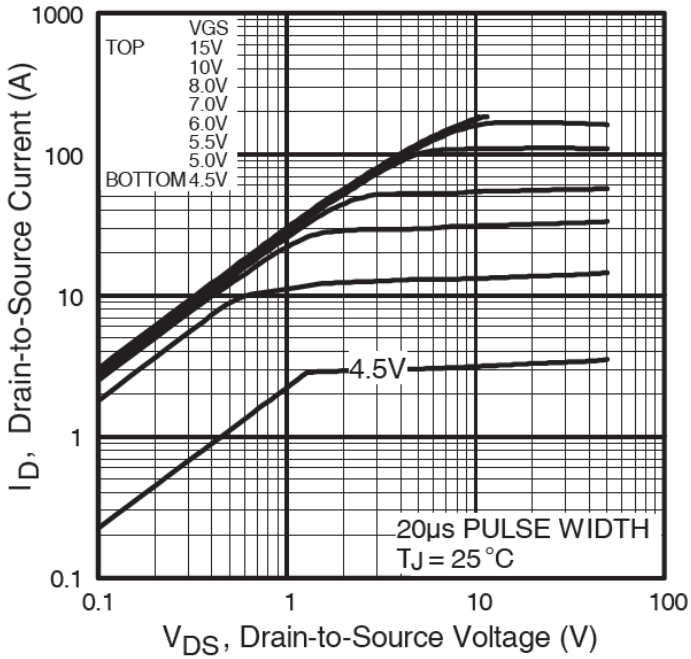
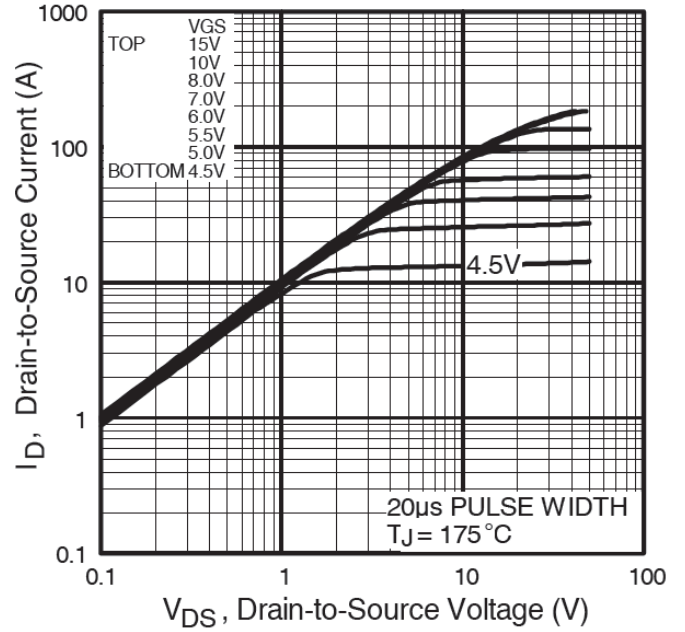
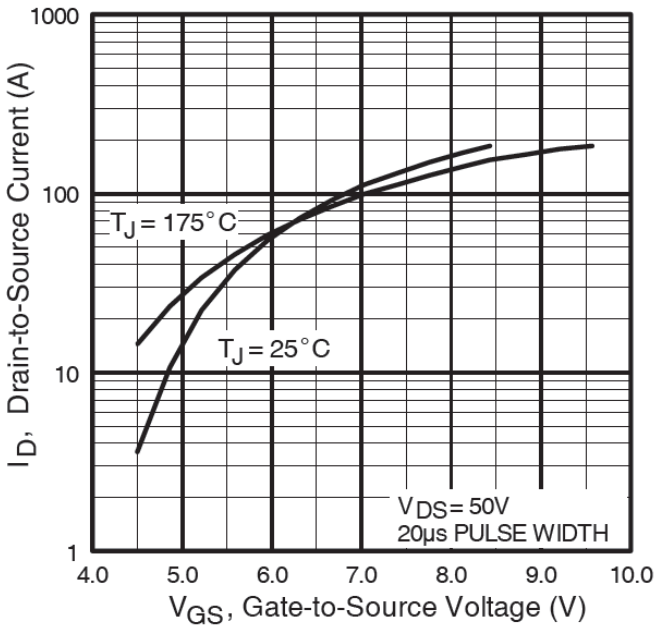
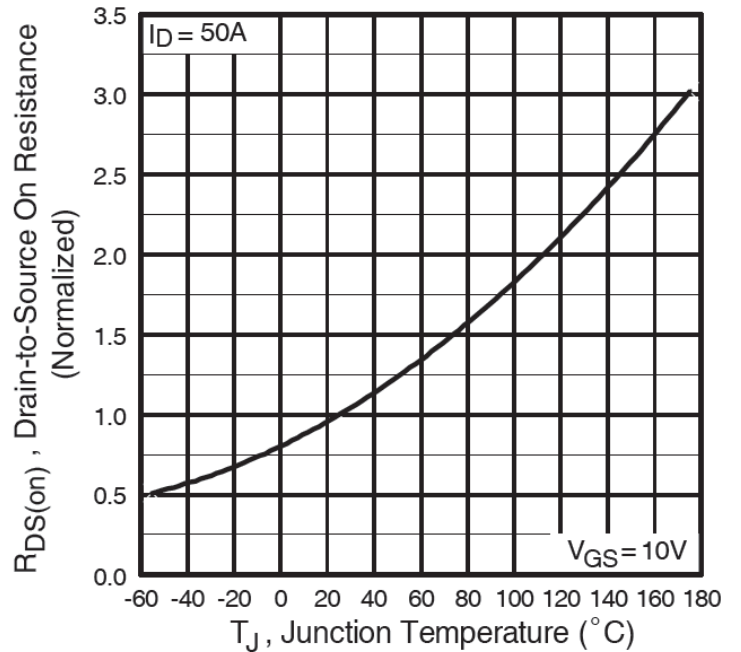
Fig. 1 Typical Output Characteristics

Fig. 2 Typical Output Characteristics

Fig. 3 Typical Transfer Characteristics

Fig. 4 Normalized On-Resistance vs. Temperature

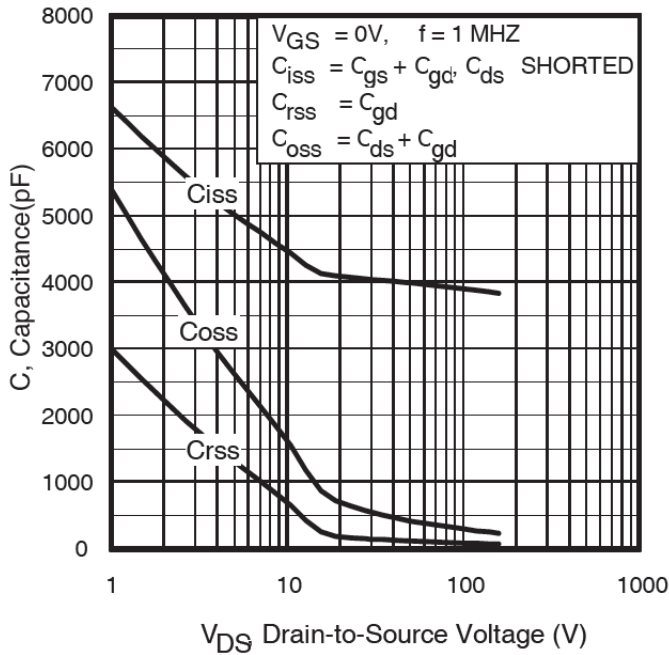

Fig 5. Typical Capacitance vs. Drain-to-Source Voltage

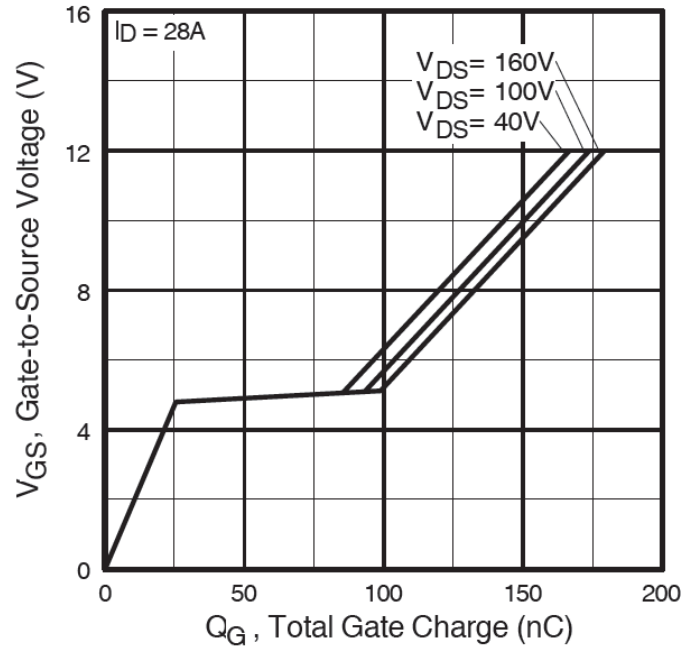

Fig 6. Typical Gate Charge vs. Gate-to-Source Voltage

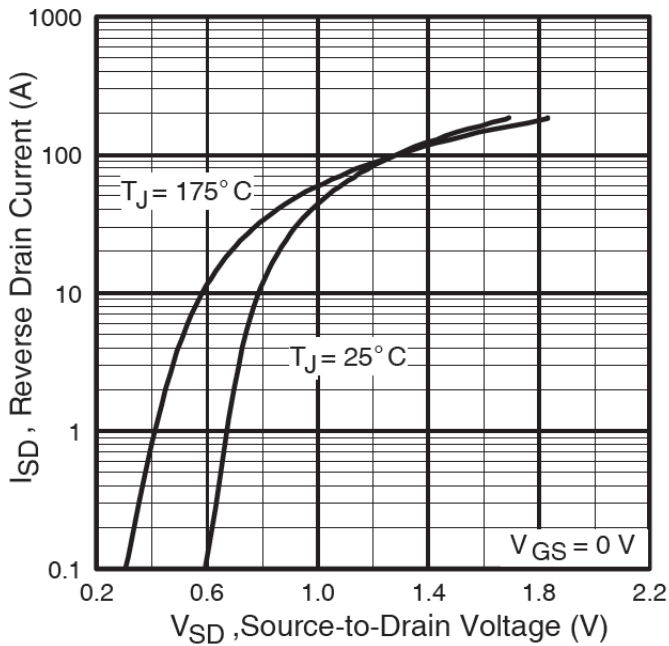

Fig. 7 Typical Source-to-Drain Diode Forward Voltage

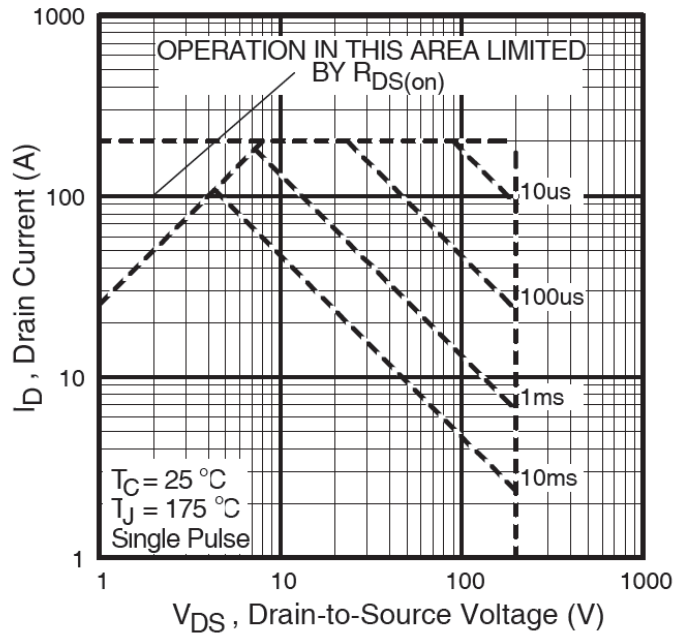

Fig 8. Maximum Safe Operating Area

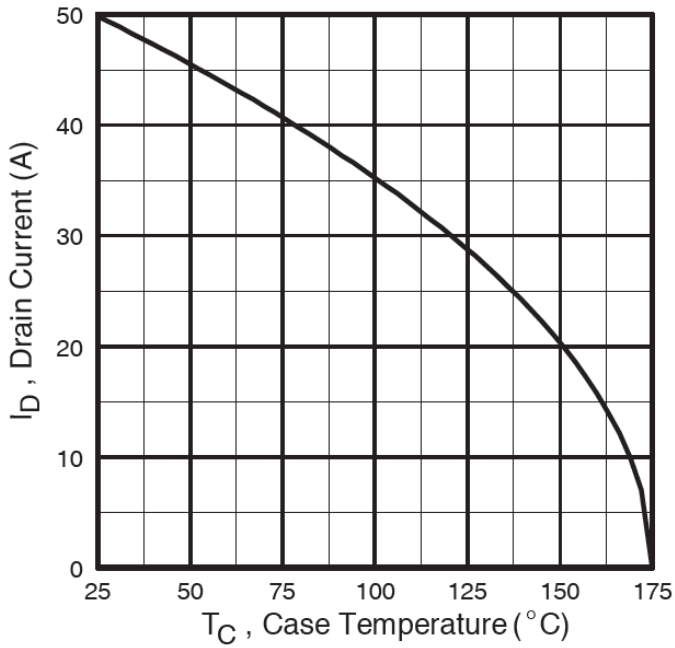

Fig 9. Maximum Drain Current vs. Case Temperature

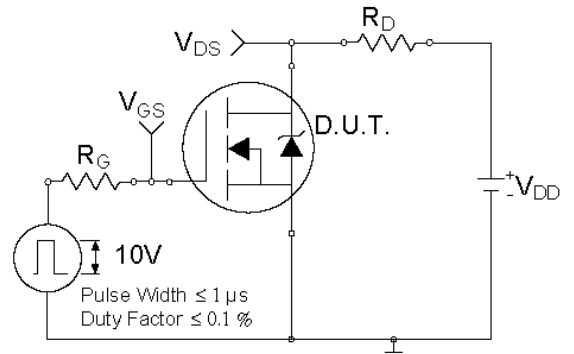

Fig 10a. Switching Time Test Circuit

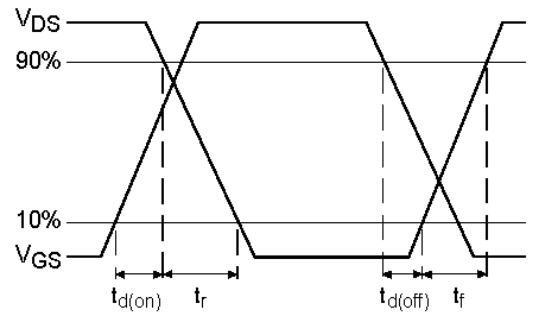

Fig 10a. Switching Time Waveforms

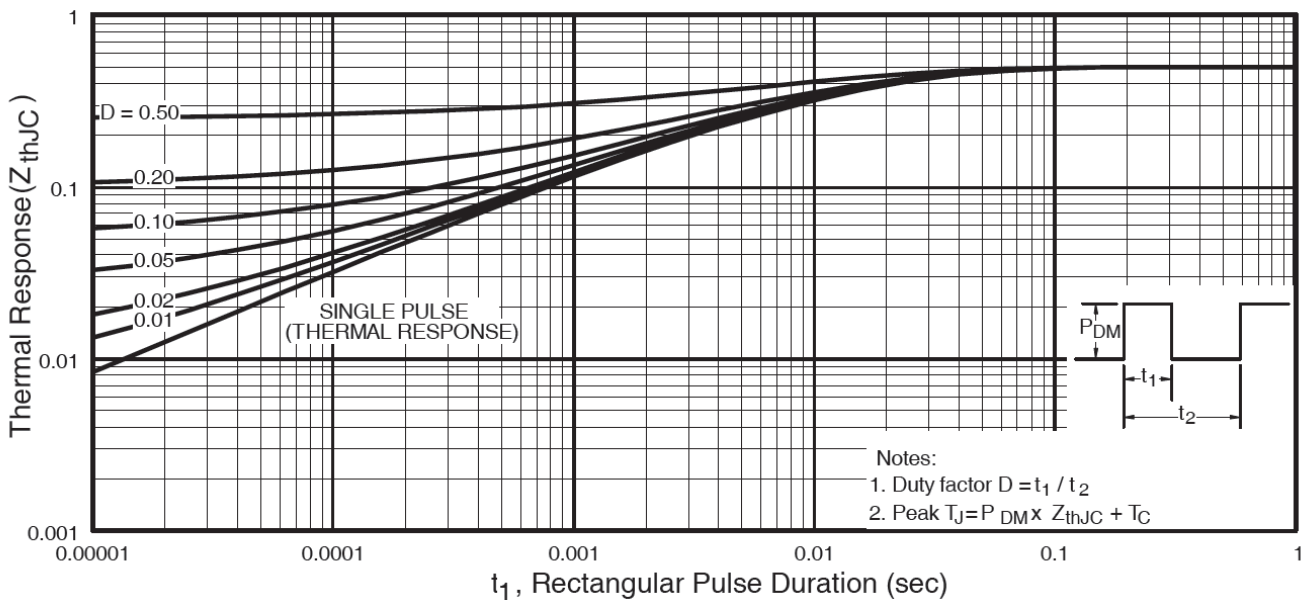
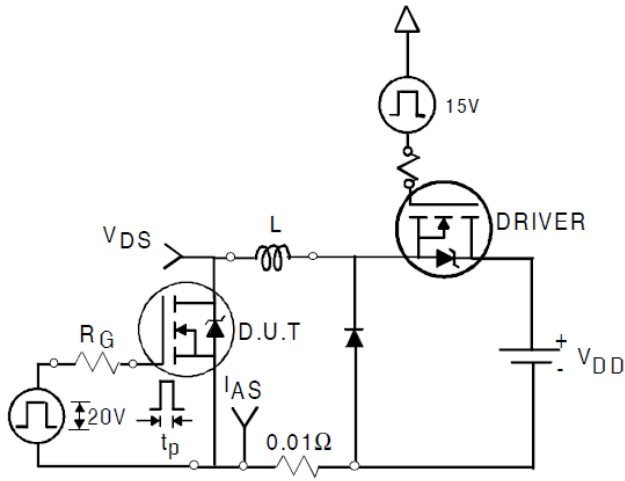
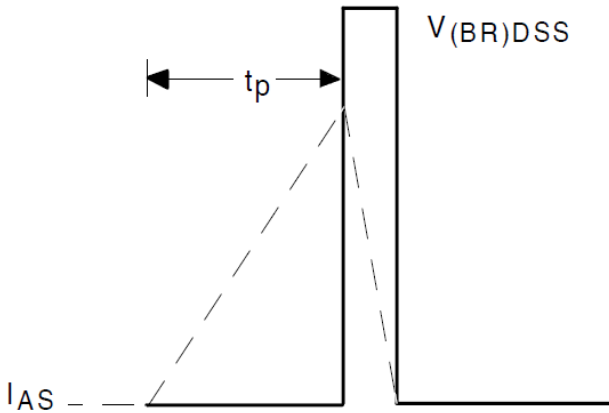
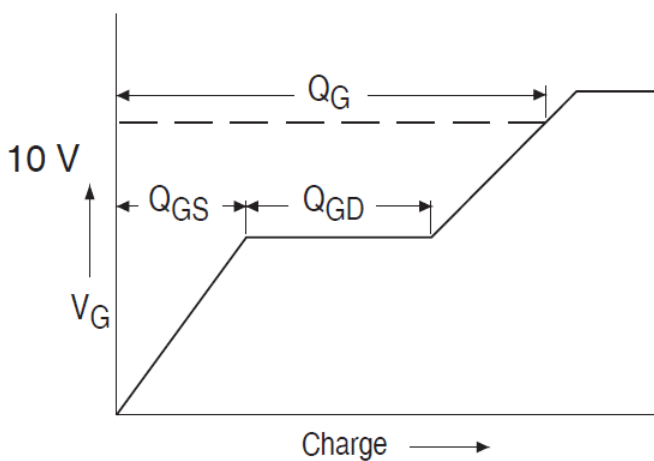
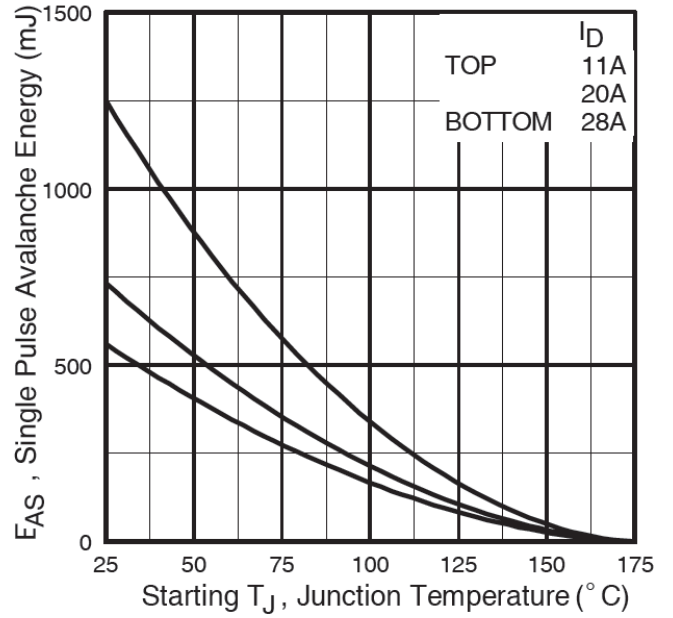
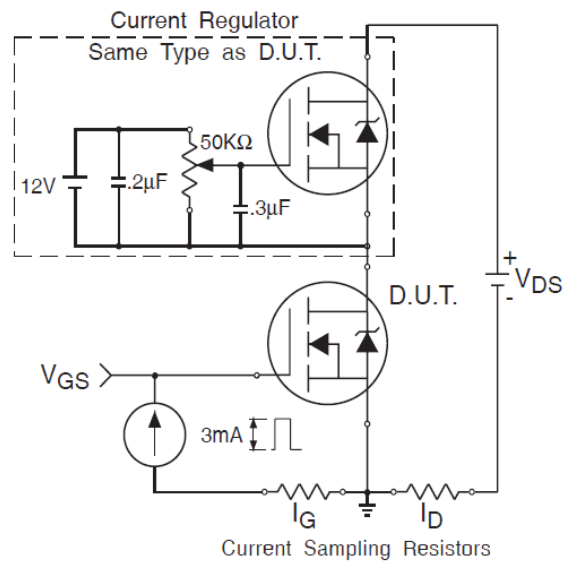

Fig 11. Maximum Effective Transient Thermal Impedance, Junction-to-Case

Fig. 12a. Unclamped Inductive Test Circuit

Fig. 12b. Unclamped Inductive Waveforms

Fig 13a. Basic Gate Charge Waveform

Fig 12c. Maximum Avalanche Energy vs. Drain Current

Fig 13b. Gate Charge Test Circuit

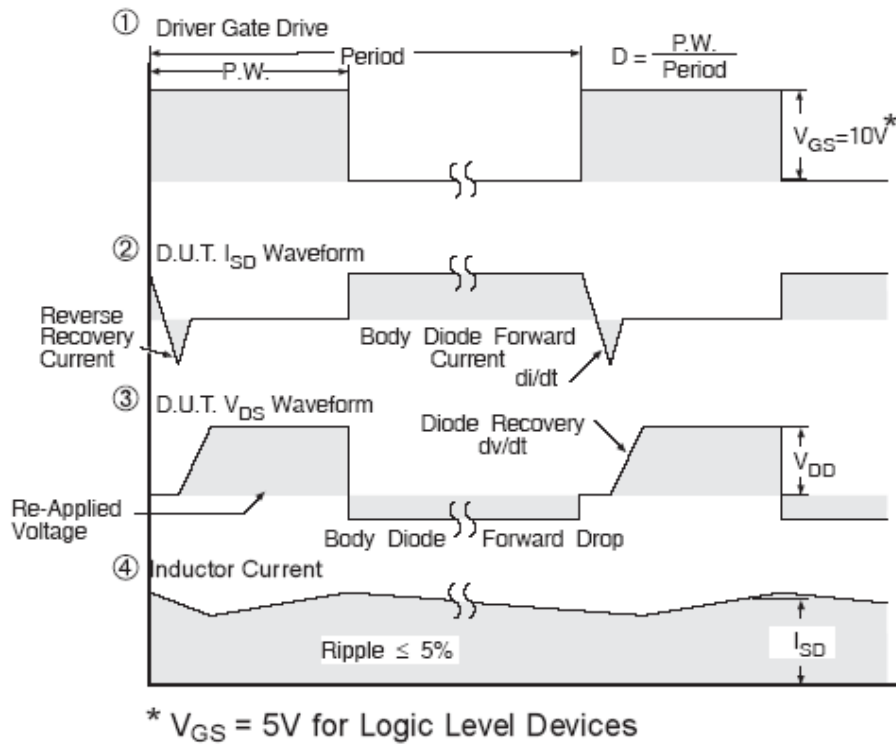
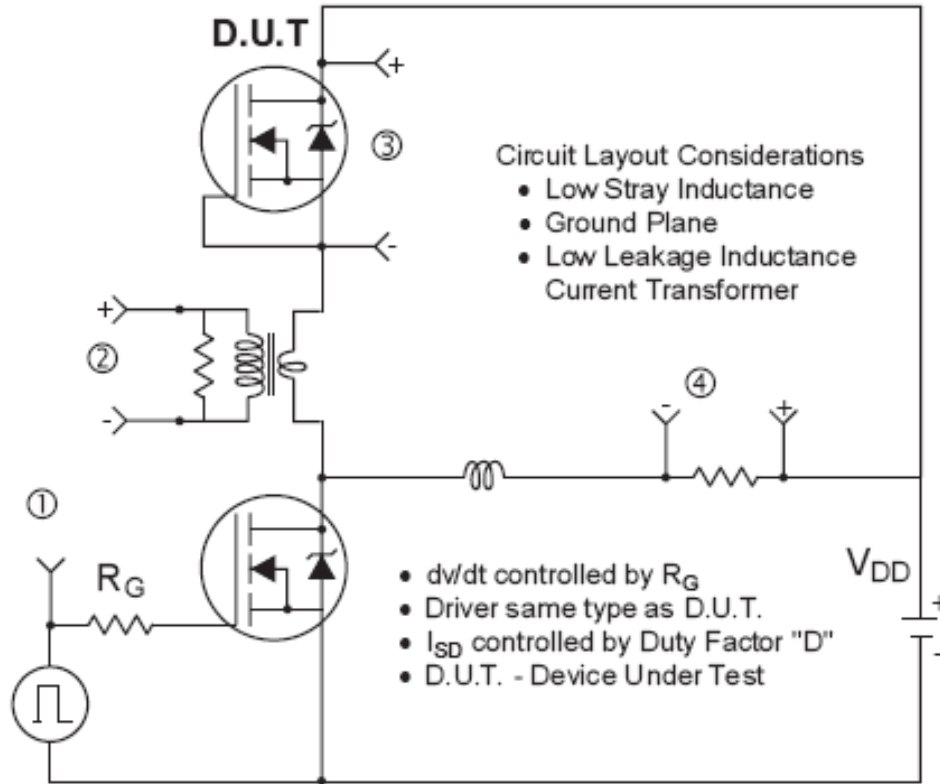
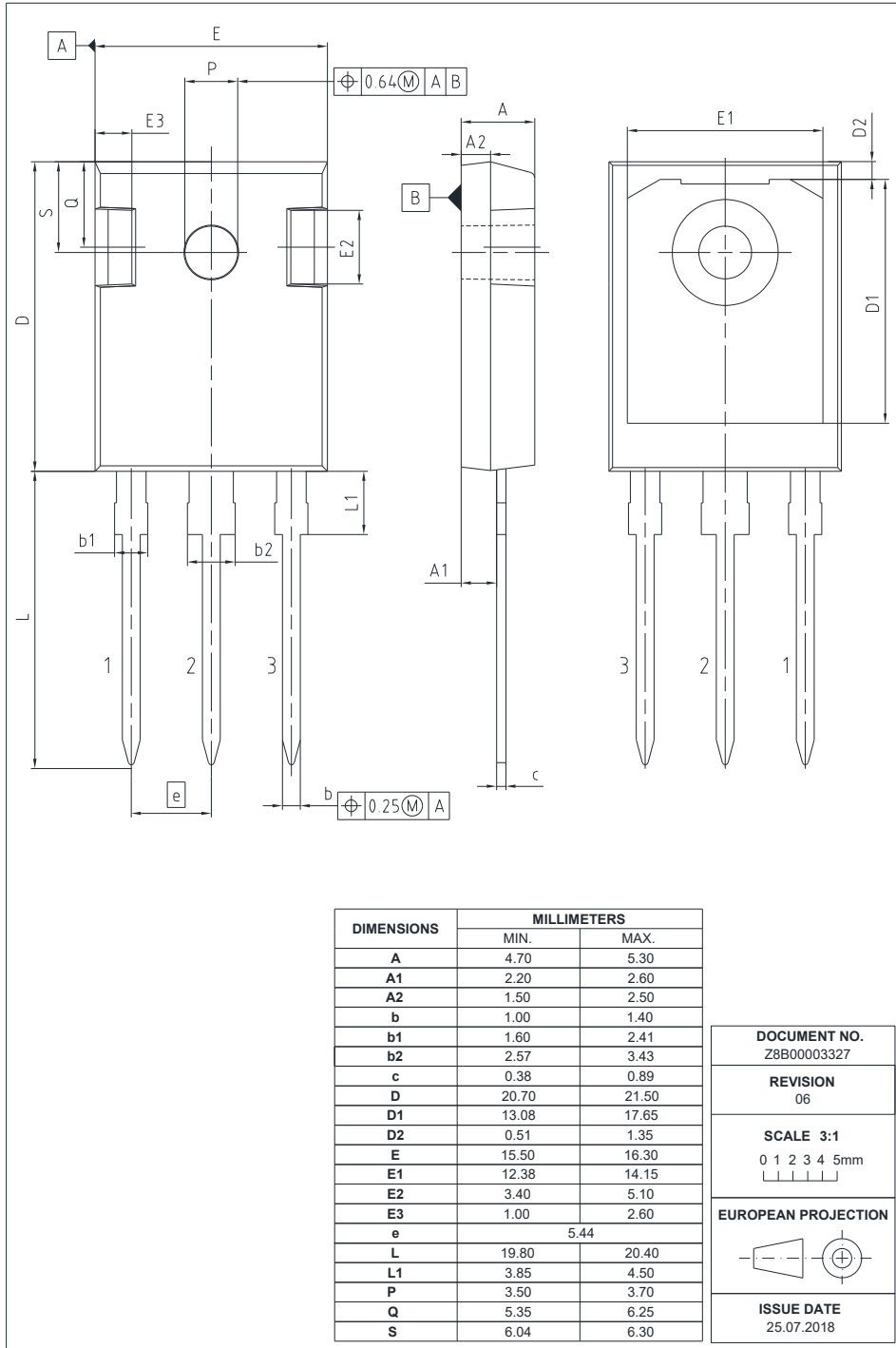
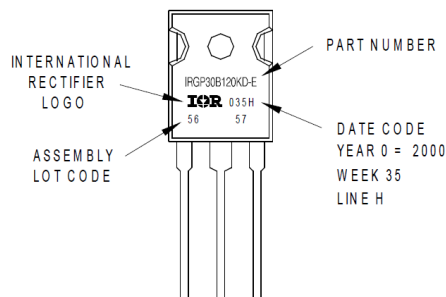

Fig 14. Peak Diode Recovery dv/dt Test Circuit for N-Channel IR MOSFET™

TO-247AD Package Outline (Dimensions are shown in millimeters (inches))

TO-247AD Part Marking Information

EXAMPLE: THIS IS AN IRGP30B120KD-E
WITH ASSEMBLY
LOT CODE 5657
ASSEMBLED ON WW 35, 2000
IN THE ASSEMBLY LINE "H"

Note: "P" in assembly line position
indicates "Lead-Free"



Revision History

| Date | Comments |
|------------|--|
| 05/28/2020 | <ul style="list-style-type: none"> • Updated datasheet with corporate template • Updated Package picture-page1 • Corrected from “Hexfet power MOSFET” to “ IR MOSFET™” -page1 &7 • Corrected part marking from TO-247AC to TO-247AD on page 8. |

Published by
Infineon Technologies AG
81726 München, Germany
© Infineon Technologies AG 2015
All Rights Reserved.

IMPORTANT NOTICE

The information given in this document shall in no event be regarded as a guarantee of conditions or characteristics (“Beschaffenhheitsgarantie”). With respect to any examples, hints or any typical values stated herein and/or any information regarding the application of the product, Infineon Technologies hereby disclaims any and all warranties and liabilities of any kind, including without limitation warranties of non-infringement of intellectual property rights of any third party.

In addition, any information given in this document is subject to customer’s compliance with its obligations stated in this document and any applicable legal requirements, norms and standards concerning customer’s products and any use of the product of Infineon Technologies in customer’s applications.

The data contained in this document is exclusively intended for technically trained staff. It is the responsibility of customer’s technical departments to evaluate the suitability of the product for the intended application and the completeness of the product information given in this document with respect to such application.

For further information on the product, technology, delivery terms and conditions and prices please contact your nearest Infineon Technologies office (www.infineon.com).

WARNINGS

Due to technical requirements products may contain dangerous substances. For information on the types in question please contact your nearest Infineon Technologies office.

Except as otherwise explicitly approved by Infineon Technologies in a written document signed by authorized representatives of Infineon Technologies, Infineon Technologies’ products may not be used in any applications where a failure of the product or any consequences of the use thereof can reasonably be expected to result in personal injury.







Looking for pricing, stock, or lifecycle information?

Click below to explore more details on WIN SOURCE:

 [View IRFP260MPBF](#) on WIN SOURCE

 [Infineon Technologies](#) Information

Optimize Your Supply Chain with WIN SOURCE Solutions

-  Global Sourcing Solution
-  Obsolete Management
-  Cost Control Management
-  Shortage Management
-  Alternative Solution
-  Excess Inventory Management