



# THE DATASHEET OF IRFR430APBF



## Power MOSFET

PRODUCT SUMMARY	
$V_{DS}$ (V)	500
$R_{DS(on)}$ ( $\Omega$ )	$V_{GS} = 10\text{ V}$   1.7
$Q_g$ (Max.) (nC)	24
$Q_{gs}$ (nC)	6.5
$Q_{gd}$ (nC)	13
Configuration	Single

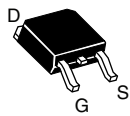
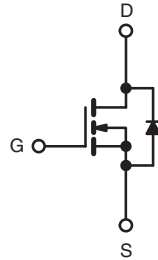
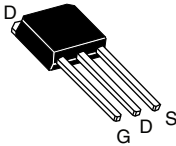
**DPAK (TO-252)**

**IPAK (TO-251)**

N-Channel MOSFET

### FEATURES

- Low Gate Charge  $Q_g$  Results in Simple Drive Requirement
- Improved Gate, Avalanche and Dynamic  $dV/dt$  Ruggedness
- Fully Characterized Capacitance and Avalanche Voltage and Current
- Effective  $C_{oss}$  Specified
- Material categorization: For definitions of compliance please see [www.vishay.com/doc?99912](http://www.vishay.com/doc?99912)

**RoHS**  
 COMPLIANT  
 HALOGEN  
**FREE**  
 Available

### APPLICATIONS

- Switch Mode Power Supply (SMPS)
- Uninterruptible Power Supply
- High Speed Power Switching

ORDERING INFORMATION					
Package	DPAK (TO-252)	DPAK (TO-252)	DPAK (TO-252)	DPAK (TO-252)	IPAK (TO-251)
Lead (Pb)-free and Halogen-free	SiHFR430A-GE3	SiHFR430ATR-GE3 <sup>a</sup>	SiHFR430ATRL-GE3 <sup>a</sup>	SiHFR430ATRR-GE3 <sup>a</sup>	SiHFU430A-GE3
Lead (Pb)-free	IRFR430APbF	IRFR430ATRPbF <sup>a</sup>	IRFR430ATRLPbF <sup>a</sup>	IRFR430ATRRPbF <sup>a</sup>	IRFU430APbF
	SiHFR430A-E3	SiHFR430AT-E3 <sup>a</sup>	SiHFR430ATL-E3 <sup>a</sup>	SiHFR430ATR-E3 <sup>a</sup>	SiHFU430A-E3

#### Note

- a. See device orientation.

ABSOLUTE MAXIMUM RATINGS ( $T_C = 25\text{ }^\circ\text{C}$ , unless otherwise noted)					
PARAMETER	SYMBOL		LIMIT	UNIT	
Drain-Source Voltage	$V_{DS}$		500	V	
Gate-Source Voltage	$V_{GS}$		$\pm 30$		
Continuous Drain Current	$V_{GS}$ at 10 V	$T_C = 25\text{ }^\circ\text{C}$	5.0	A	
		$T_C = 100\text{ }^\circ\text{C}$	3.2		
Pulsed Drain Current <sup>a</sup>	$I_{DM}$		20		
Linear Derating Factor			0.91	W/ $^\circ\text{C}$	
Single Pulse Avalanche Energy <sup>b</sup>	$E_{AS}$		130	mJ	
Repetitive Avalanche Current <sup>a</sup>	$I_{AR}$		5.0	A	
Repetitive Avalanche Energy <sup>a</sup>	$E_{AR}$		11	mJ	
Maximum Power Dissipation	$T_C = 25\text{ }^\circ\text{C}$		$P_D$	110	W
Peak Diode Recovery $dV/dt^c$			$dV/dt$	3.0	V/ns
Operating Junction and Storage Temperature Range	$T_J, T_{stg}$		- 55 to + 150	$^\circ\text{C}$	
Soldering Recommendations (Peak Temperature) <sup>d</sup>	for 10 s		300		

#### Notes

- a. Repetitive rating; pulse width limited by maximum junction temperature (see fig. 11).  
 b. Starting  $T_J = 25\text{ }^\circ\text{C}$ ,  $L = 11\text{ mH}$ ,  $R_g = 25\text{ }^\circ\Omega$ ,  $I_{AS} = 5.0\text{ A}$  (see fig. 12).  
 c.  $I_{SD} \leq 5.0\text{ A}$ ,  $dI/dt \leq 320\text{ A}/\mu\text{s}$ ,  $V_{DD} \leq V_{DS}$ ,  $T_J \leq 150\text{ }^\circ\text{C}$ .  
 d. 1.6 mm from case.



THERMAL RESISTANCE RATINGS				
PARAMETER	SYMBOL	TYP.	MAX.	UNIT
Maximum Junction-to-Ambient	$R_{thJA}$	-	62	°C/W
Case-to-Sink, Flat, Greased Surface	$R_{thCS}$	0.50	-	
Maximum Junction-to-Case (Drain)	$R_{thJC}$	-	1.1	

SPECIFICATIONS ( $T_J = 25\text{ }^\circ\text{C}$ , unless otherwise noted)							
PARAMETER	SYMBOL	TEST CONDITIONS	MIN.	TYP.	MAX.	UNIT	
<b>Static</b>							
Drain-Source Breakdown Voltage	$V_{DS}$	$V_{GS} = 0\text{ V}, I_D = 250\text{ }\mu\text{A}$	500	-	-	V	
$V_{DS}$ Temperature Coefficient	$\Delta V_{DS}/T_J$	Reference to $25\text{ }^\circ\text{C}, I_D = 1\text{ mA}$	-	0.60	-	V/°C	
Gate-Source Threshold Voltage	$V_{GS(th)}$	$V_{DS} = V_{GS}, I_D = 250\text{ }\mu\text{A}$	2.0	-	4.5	V	
Gate-Source Leakage	$I_{GSS}$	$V_{GS} = \pm 30\text{ V}$	-	-	$\pm 100$	nA	
Zero Gate Voltage Drain Current	$I_{DSS}$	$V_{DS} = 500\text{ V}, V_{GS} = 0\text{ V}$	-	-	25	$\mu\text{A}$	
		$V_{DS} = 400\text{ V}, V_{GS} = 0\text{ V}, T_J = 125\text{ }^\circ\text{C}$	-	-	250		
Drain-Source On-State Resistance	$R_{DS(on)}$	$V_{GS} = 10\text{ V}, I_D = 3.0\text{ A}^b$	-	-	1.7	$\Omega$	
Forward Transconductance	$g_{fs}$	$V_{DS} = 50\text{ V}, I_D = 3.0\text{ A}$	2.3	-	-	S	
<b>Dynamic</b>							
Input Capacitance	$C_{iss}$	$V_{GS} = 0\text{ V}, V_{DS} = 25\text{ V}, f = 1.0\text{ MHz}, \text{ see fig. 5}$	-	490	-	pF	
Output Capacitance	$C_{oss}$		-	75	-		
Reverse Transfer Capacitance	$C_{rss}$		-	4.5	-		
Output Capacitance	$C_{oss}$	$V_{GS} = 10\text{ V}$	$V_{DS} = 1.0\text{ V}, f = 1.0\text{ MHz}$	-	750	-	pF
			$V_{DS} = 400\text{ V}, f = 1.0\text{ MHz}$	-	25	-	
Effective Output Capacitance	$C_{oss\text{ eff.}}$			-	51	-	
Total Gate Charge	$Q_g$	$V_{GS} = 10\text{ V}, I_D = 5.0\text{ A}, V_{DS} = 400\text{ V}, \text{ see fig. 6 and 13}^b$	-	-	24	nC	
Gate-Source Charge	$Q_{gs}$		-	-	6.5		
Gate-Drain Charge	$Q_{gd}$		-	-	13		
Turn-On Delay Time	$t_{d(on)}$	$V_{DD} = 250\text{ V}, I_D = 5.0\text{ A}, R_g = 15\text{ }\Omega, R_D = 50\text{ }\Omega, \text{ see fig. 10}^b$	-	8.7	-	ns	
Rise Time	$t_r$		-	27	-		
Turn-Off Delay Time	$t_{d(off)}$		-	17	-		
Fall Time	$t_f$		-	16	-		
<b>Drain-Source Body Diode Characteristics</b>							
Continuous Source-Drain Diode Current	$I_S$	MOSFET symbol showing the integral reverse p - n junction diode 	-	-	5.0	A	
Pulsed Diode Forward Current <sup>a</sup>	$I_{SM}$		-	-	20		
Body Diode Voltage	$V_{SD}$	$T_J = 25\text{ }^\circ\text{C}, I_S = 5.0\text{ A}, V_{GS} = 0\text{ V}^b$	-	-	1.5	V	
Body Diode Reverse Recovery Time	$t_{rr}$	$T_J = 25\text{ }^\circ\text{C}, I_F = 5.0\text{ A}, di/dt = 100\text{ A}/\mu\text{s}^b$	-	410	620	ns	
Body Diode Reverse Recovery Charge	$Q_{rr}$		-	1.4	2.1	$\mu\text{C}$	
Forward Turn-On Time	$t_{on}$	Intrinsic turn-on time is negligible (turn-on is dominated by $L_S$ and $L_D$ )					

**Notes**

- a. Repetitive rating; pulse width limited by maximum junction temperature (see fig. 11).
- b. Pulse width  $\leq 300\text{ }\mu\text{s}$ ; duty cycle  $\leq 2\%$ .
- c.  $C_{oss\text{ eff.}}$  is a fixed capacitance that gives the same charging time as  $C_{oss}$  while  $V_{DS}$  is rising from 0 to 80 %  $V_{DS}$ .



## TYPICAL CHARACTERISTICS (25 °C, unless otherwise noted)

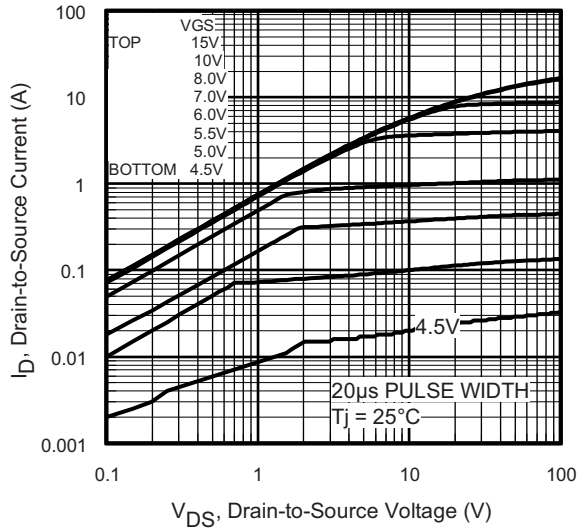

Fig. 1 - Typical Output Characteristics

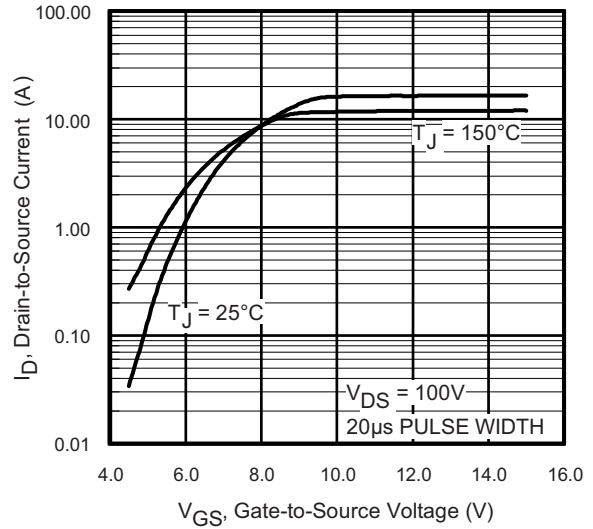

Fig. 3 - Typical Transfer Characteristics

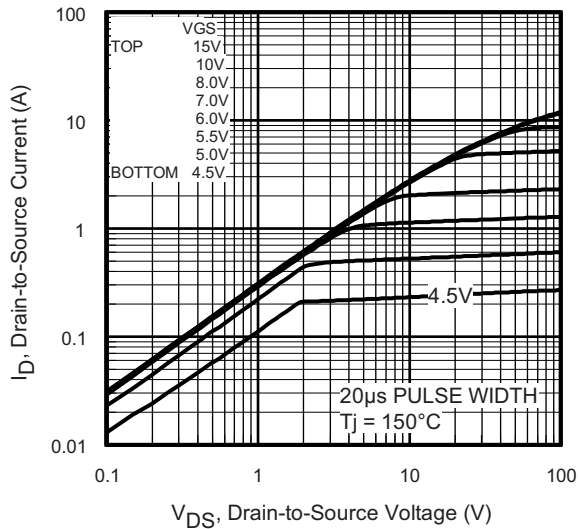

Fig. 2 - Typical Output Characteristics

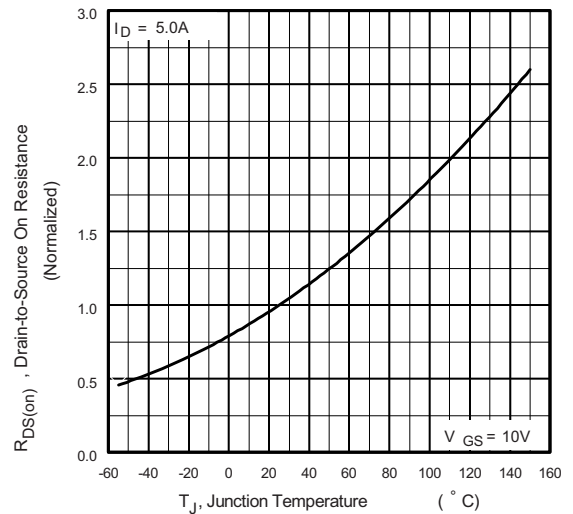

Fig. 4 - Normalized On-Resistance vs. Temperature

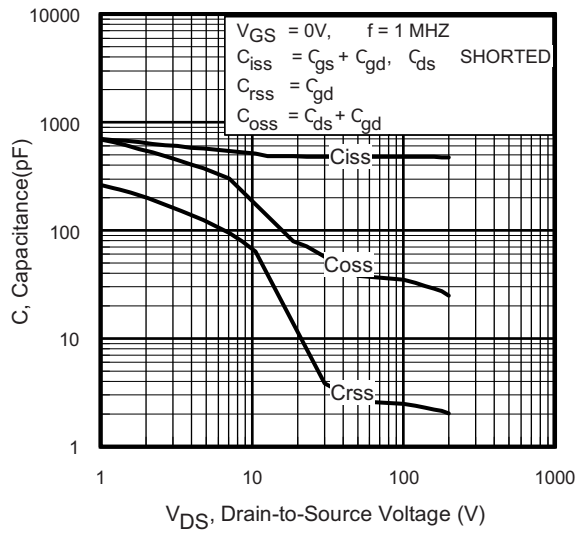

Fig. 5 - Typical Capacitance vs. Drain-to-Source Voltage

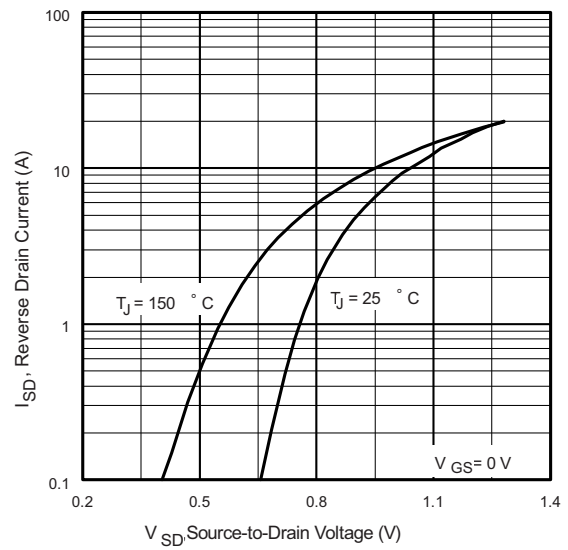

Fig. 7 - Typical Source-Drain Diode Forward Voltage

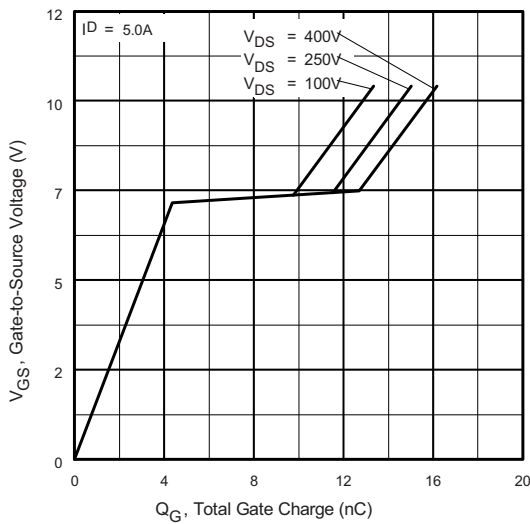

Fig. 6 - Typical Gate Charge vs. Gate-to-Source Voltage

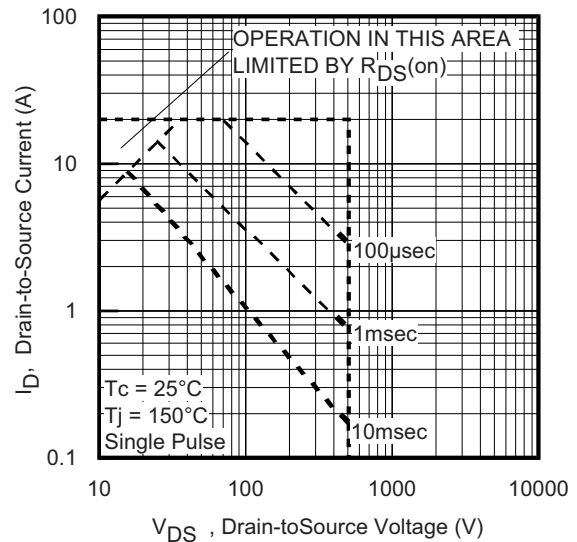

Fig. 8 - Maximum Safe Operating Area

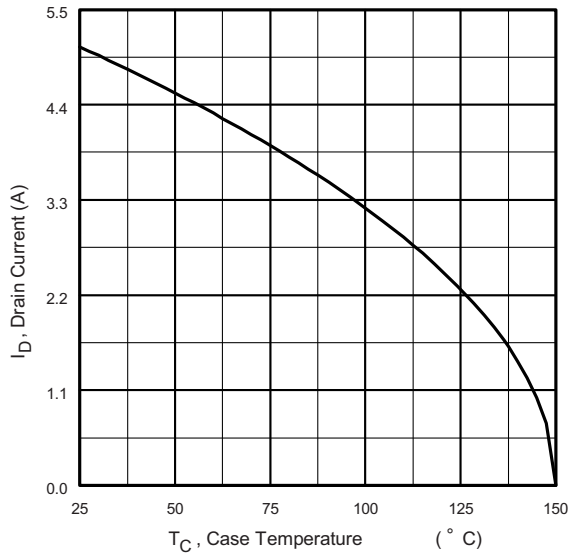

Fig. 9 - Maximum Drain Current vs. Case Temperature

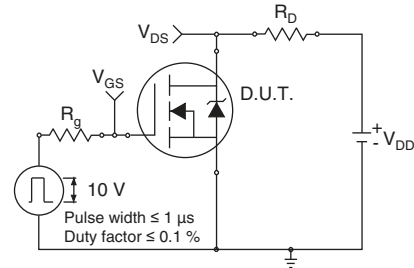

Fig. 10a - Switching Time Test Circuit

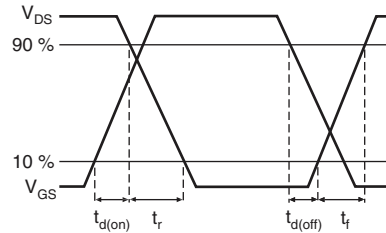

Fig. 10b - Switching Time Waveforms

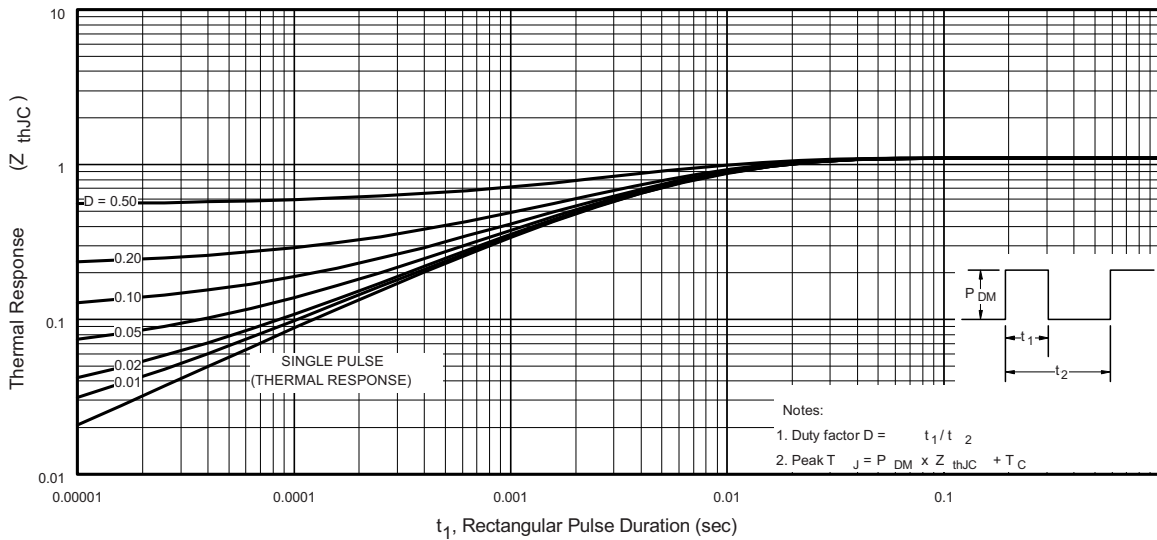

Fig. 11 - Maximum Effective Transient Thermal Impedance, Junction-to-Case

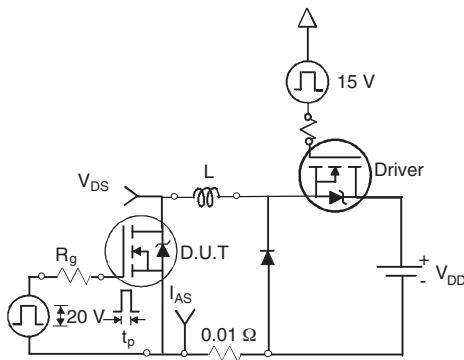

Fig. 12a - Unclamped Inductive Test Circuit

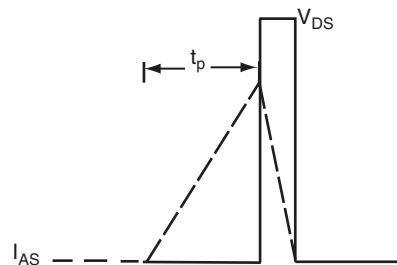

Fig. 12b - Unclamped Inductive Waveforms

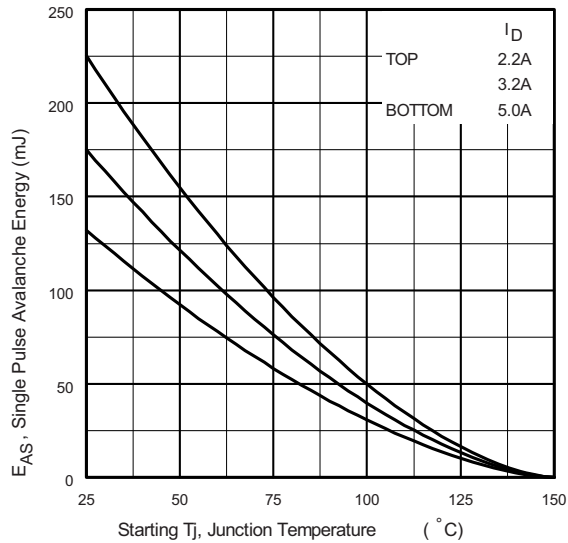

Fig. 12c - Maximum Avalanche Energy vs. Drain Current

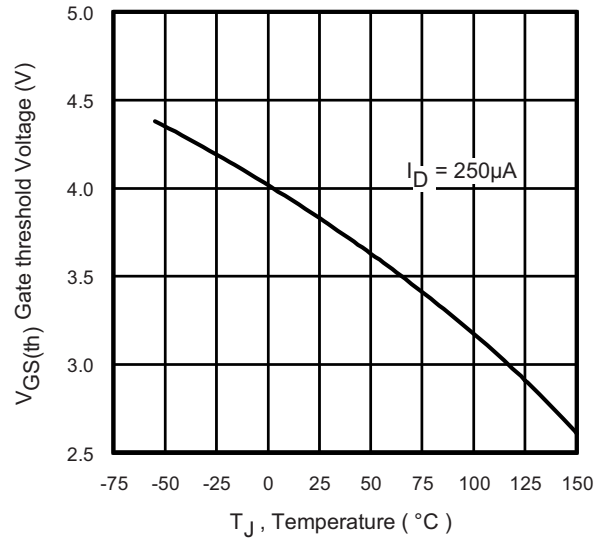

Fig. 12d - Threshold Voltage vs. Temperature

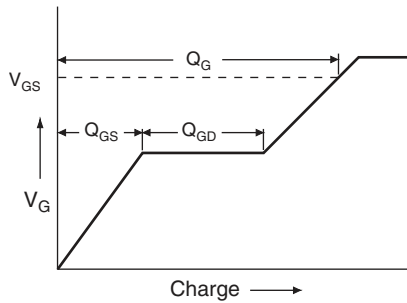

Fig. 13a - Basic Gate Charge Waveform

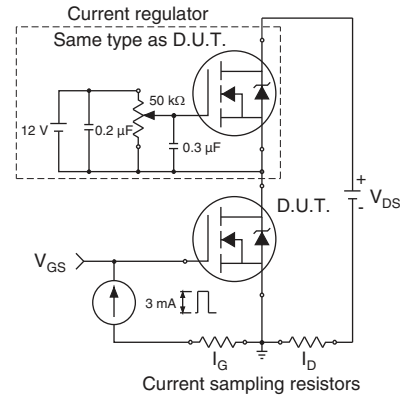
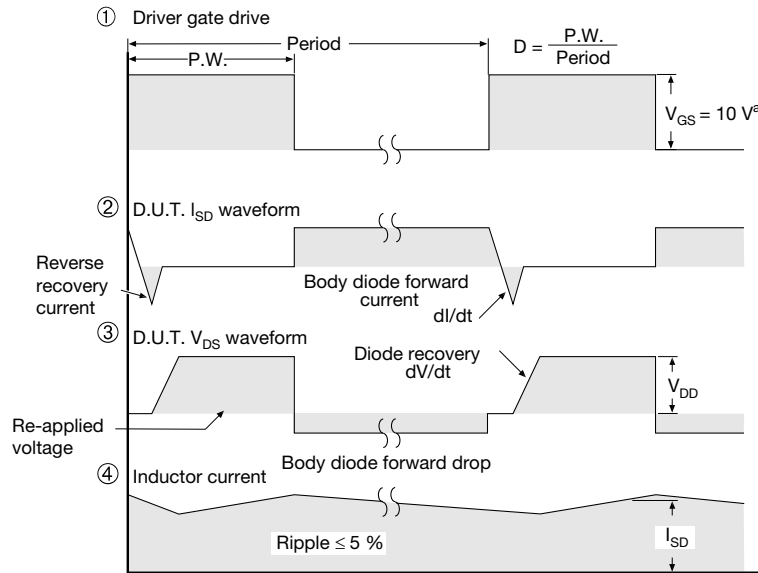
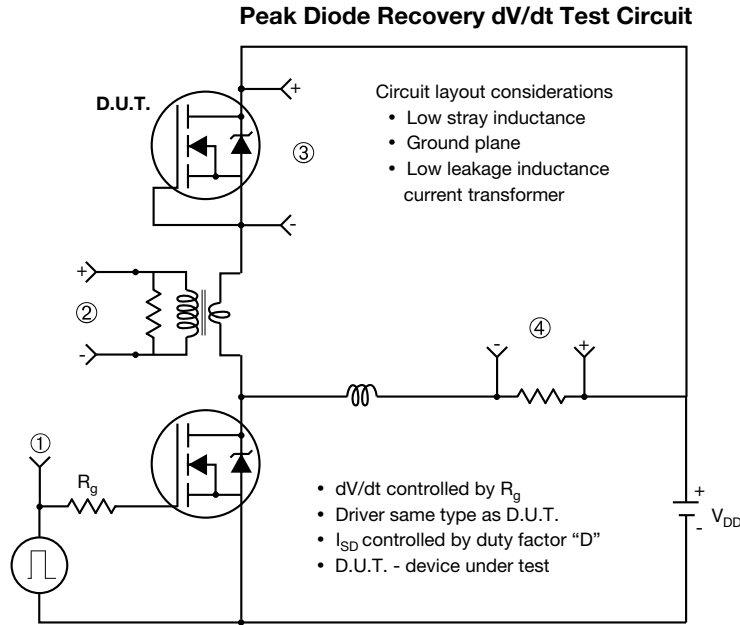

Fig. 13b - Gate Charge Test Circuit



**Note**  
a.  $V_{GS} = 5\text{ V}$  for logic level devices

**Fig. 14 - For N-Channel**

Vishay Siliconix maintains worldwide manufacturing capability. Products may be manufactured at one of several qualified locations. Reliability data for Silicon Technology and Package Reliability represent a composite of all qualified locations. For related documents such as package/tape drawings, part marking, and reliability data, see [www.vishay.com/ppg?91276](http://www.vishay.com/ppg?91276).



### TO-252AA Case Outline



DIM.	MILLIMETERS		INCHES	
	MIN.	MAX.	MIN.	MAX.
A	2.18	2.38	0.086	0.094
A1	-	0.127	-	0.005
b	0.64	0.88	0.025	0.035
b2	0.76	1.14	0.030	0.045
b3	4.95	5.46	0.195	0.215
C	0.46	0.61	0.018	0.024
C2	0.46	0.89	0.018	0.035
D	5.97	6.22	0.235	0.245
D1	4.10	-	0.161	-
E	6.35	6.73	0.250	0.265
E1	4.32	-	0.170	-
H	9.40	10.41	0.370	0.410
e	2.28 BSC		0.090 BSC	
e1	4.56 BSC		0.180 BSC	
L	1.40	1.78	0.055	0.070
L3	0.89	1.27	0.035	0.050
L4	-	1.02	-	0.040
L5	1.01	1.52	0.040	0.060
ECN: T16-0236-Rev. P, 16-May-16 DWG: 5347				

**Notes**

- Dimension L3 is for reference only.

### TO-251AA (HIGH VOLTAGE)



DIM.	MILLIMETERS		INCHES	
	MIN.	MAX.	MIN.	MAX.
A	2.18	2.39	0.086	0.094
A1	0.89	1.14	0.035	0.045
b	0.64	0.89	0.025	0.035
b1	0.65	0.79	0.026	0.031
b2	0.76	1.14	0.030	0.045
b3	0.76	1.04	0.030	0.041
b4	4.95	5.46	0.195	0.215
c	0.46	0.61	0.018	0.024
c1	0.41	0.56	0.016	0.022
c2	0.46	0.86	0.018	0.034
D	5.97	6.22	0.235	0.245

DIM.	MILLIMETERS		INCHES	
	MIN.	MAX.	MIN.	MAX.
D1	5.21	-	0.205	-
E	6.35	6.73	0.250	0.265
E1	4.32	-	0.170	-
e	2.29 BSC		2.29 BSC	
L	8.89	9.65	0.350	0.380
L1	1.91	2.29	0.075	0.090
L2	0.89	1.27	0.035	0.050
L3	1.14	1.52	0.045	0.060
theta1	0'	15'	0'	15'
theta2	25'	35'	25'	35'

ECN: S-82111-Rev. A, 15-Sep-08  
DWG: 5968

#### Notes

1. Dimensioning and tolerancing per ASME Y14.5M-1994.
2. Dimension are shown in inches and millimeters.
3. Dimension D and E do not include mold flash. Mold flash shall not exceed 0.13 mm (0.005") per side. These dimensions are measured at the outermost extremes of the plastic body.
4. Thermal pad contour optional with dimensions b4, L2, E1 and D1.
5. Lead dimension uncontrolled in L3.
6. Dimension b1, b3 and c1 apply to base metal only.
7. Outline conforms to JEDEC outline TO-251AA.

## RECOMMENDED MINIMUM PADS FOR DPAK (TO-252)



Recommended Minimum Pads  
Dimensions in Inches/(mm)

[Return to Index](#)



## **Disclaimer**

ALL PRODUCT, PRODUCT SPECIFICATIONS AND DATA ARE SUBJECT TO CHANGE WITHOUT NOTICE TO IMPROVE RELIABILITY, FUNCTION OR DESIGN OR OTHERWISE.

Vishay Intertechnology, Inc., its affiliates, agents, and employees, and all persons acting on its or their behalf (collectively, "Vishay"), disclaim any and all liability for any errors, inaccuracies or incompleteness contained in any datasheet or in any other disclosure relating to any product.

Vishay makes no warranty, representation or guarantee regarding the suitability of the products for any particular purpose or the continuing production of any product. To the maximum extent permitted by applicable law, Vishay disclaims (i) any and all liability arising out of the application or use of any product, (ii) any and all liability, including without limitation special, consequential or incidental damages, and (iii) any and all implied warranties, including warranties of fitness for particular purpose, non-infringement and merchantability.

Statements regarding the suitability of products for certain types of applications are based on Vishay's knowledge of typical requirements that are often placed on Vishay products in generic applications. Such statements are not binding statements about the suitability of products for a particular application. It is the customer's responsibility to validate that a particular product with the properties described in the product specification is suitable for use in a particular application. Parameters provided in datasheets and / or specifications may vary in different applications and performance may vary over time. All operating parameters, including typical parameters, must be validated for each customer application by the customer's technical experts. Product specifications do not expand or otherwise modify Vishay's terms and conditions of purchase, including but not limited to the warranty expressed therein.

Except as expressly indicated in writing, Vishay products are not designed for use in medical, life-saving, or life-sustaining applications or for any other application in which the failure of the Vishay product could result in personal injury or death. Customers using or selling Vishay products not expressly indicated for use in such applications do so at their own risk. Please contact authorized Vishay personnel to obtain written terms and conditions regarding products designed for such applications.

No license, express or implied, by estoppel or otherwise, to any intellectual property rights is granted by this document or by any conduct of Vishay. Product names and markings noted herein may be trademarks of their respective owners.

## Looking for pricing, stock, or lifecycle information?

Click below to explore more details on WIN SOURCE:

 [View IRFR430APBF on WIN SOURCE](#)

 [Vishay Information](#)

## Optimize Your Supply Chain with WIN SOURCE Solutions

-  Global Sourcing Solution
-  Obsolete Management
-  Cost Control Management
-  Shortage Management
-  Alternative Solution
-  Excess Inventory Management