



**THE DATASHEET OF  
IRFR4620TRLPBF**



# IRFR4620PbF IRFU4620PbF

HEXFET® Power MOSFET

### Applications

- High Efficiency Synchronous Rectification in SMPS
- Uninterruptible Power Supply
- High Speed Power Switching
- Hard Switched and High Frequency Circuits

### Benefits

- Improved Gate, Avalanche and Dynamic dV/dt Ruggedness
- Fully Characterized Capacitance and Avalanche SOA
- Enhanced body diode dV/dt and dI/dt Capability
- Lead-Free

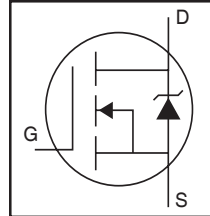

$V_{DSS}$		<b>200V</b>
$R_{DS(on)}$	typ.	<b>64mΩ</b>
	max.	<b>78mΩ</b>
$I_D$		<b>24A</b>

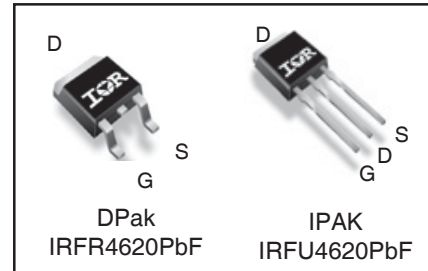

<b>G</b>	<b>D</b>	<b>S</b>
Gate	Drain	Source

### Absolute Maximum Ratings

Symbol	Parameter	Max.	Units
$I_D @ T_C = 25^\circ\text{C}$	Continuous Drain Current, $V_{GS} @ 10\text{V}$	24	A
$I_D @ T_C = 100^\circ\text{C}$	Continuous Drain Current, $V_{GS} @ 10\text{V}$	17	
$I_{DM}$	Pulsed Drain Current ①	100	
$P_D @ T_C = 25^\circ\text{C}$	Maximum Power Dissipation	144	W
	Linear Derating Factor	0.96	W/°C
$V_{GS}$	Gate-to-Source Voltage	± 20	V
dv/dt	Peak Diode Recovery ③	54	V/ns
$T_J$ $T_{STG}$	Operating Junction and Storage Temperature Range	-55 to + 175	°C
	Soldering Temperature, for 10 seconds (1.6mm from case)	300	

### Avalanche Characteristics

$E_{AS}$ (Thermally limited)	Single Pulse Avalanche Energy ②	113	mJ
$I_{AR}$	Avalanche Current ①	See Fig. 14, 15, 22a, 22b,	A
$E_{AR}$	Repetitive Avalanche Energy ①		mJ

### Thermal Resistance

Symbol	Parameter	Typ.	Max.	Units
$R_{\theta JC}$	Junction-to-Case ⑧	—	1.045	°C/W
$R_{\theta JA}$	Junction-to-Ambient (PCB Mount) ⑦	—	50	
$R_{\theta JA}$	Junction-to-Ambient	—	110	

### ORDERING INFORMATION:

See detailed ordering and shipping information on the last page of this data sheet.

Notes ① through ⑧ are on page 11

**Static @ T<sub>J</sub> = 25°C (unless otherwise specified)**

Symbol	Parameter	Min.	Typ.	Max.	Units	Conditions
V <sub>(BR)DSS</sub>	Drain-to-Source Breakdown Voltage	200	—	—	V	V <sub>GS</sub> = 0V, I <sub>D</sub> = 250μA
ΔV <sub>(BR)DSS/ΔT<sub>J</sub></sub>	Breakdown Voltage Temp. Coefficient	—	0.23	—	V/°C	Reference to 25°C, I <sub>D</sub> = 5mA①
R <sub>DS(on)</sub>	Static Drain-to-Source On-Resistance	—	64	78	mΩ	V <sub>GS</sub> = 10V, I <sub>D</sub> = 15A ④
V <sub>GS(th)</sub>	Gate Threshold Voltage	3.0	—	5.0	V	V <sub>DS</sub> = V <sub>GS</sub> , I <sub>D</sub> = 100μA
I <sub>DSS</sub>	Drain-to-Source Leakage Current	—	—	20	μA	V <sub>DS</sub> = 200V, V <sub>GS</sub> = 0V
		—	—	250		V <sub>DS</sub> = 200V, V <sub>GS</sub> = 0V, T <sub>J</sub> = 125°C
I <sub>GSS</sub>	Gate-to-Source Forward Leakage	—	—	100	nA	V <sub>GS</sub> = 20V
	Gate-to-Source Reverse Leakage	—	—	-100		V <sub>GS</sub> = -20V
R <sub>G(int)</sub>	Internal Gate Resistance	—	2.6	—	Ω	

**Dynamic @ T<sub>J</sub> = 25°C (unless otherwise specified)**

Symbol	Parameter	Min.	Typ.	Max.	Units	Conditions
g <sub>fs</sub>	Forward Transconductance	37	—	—	S	V <sub>DS</sub> = 50V, I <sub>D</sub> = 15A
Q <sub>g</sub>	Total Gate Charge	—	25	38	nC	I <sub>D</sub> = 15A
Q <sub>gs</sub>	Gate-to-Source Charge	—	8.2	—		V <sub>DS</sub> = 100V
Q <sub>gd</sub>	Gate-to-Drain ("Miller") Charge	—	7.9	—		V <sub>GS</sub> = 10V ④
Q <sub>sync</sub>	Total Gate Charge Sync. (Q <sub>g</sub> - Q <sub>gd</sub> )	—	17	—		I <sub>D</sub> = 15A, V <sub>DS</sub> = 0V, V <sub>GS</sub> = 10V
t <sub>d(on)</sub>	Turn-On Delay Time	—	13.4	—	ns	V <sub>DD</sub> = 130V
t <sub>r</sub>	Rise Time	—	22.4	—		I <sub>D</sub> = 15A
t <sub>d(off)</sub>	Turn-Off Delay Time	—	25.4	—		R <sub>G</sub> = 7.3Ω
t <sub>f</sub>	Fall Time	—	14.8	—		V <sub>GS</sub> = 10V ④
C <sub>iss</sub>	Input Capacitance	—	1710	—	pF	V <sub>GS</sub> = 0V
C <sub>oss</sub>	Output Capacitance	—	125	—		V <sub>DS</sub> = 50V
C <sub>rss</sub>	Reverse Transfer Capacitance	—	30	—		f = 1.0MHz (See Fig.5)
C <sub>oss eff. (ER)</sub>	Effective Output Capacitance (Energy Related)⑥	—	113	—		V <sub>GS</sub> = 0V, V <sub>DS</sub> = 0V to 160V ⑥(See Fig.11)
C <sub>oss eff. (TR)</sub>	Effective Output Capacitance (Time Related)⑤	—	317	—		V <sub>GS</sub> = 0V, V <sub>DS</sub> = 0V to 160V ⑤

**Diode Characteristics**

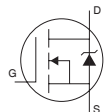
Symbol	Parameter	Min.	Typ.	Max.	Units	Conditions
I <sub>S</sub>	Continuous Source Current (Body Diode)	—	—	24	A	MOSFET symbol showing the integral reverse p-n junction diode. 
I <sub>SM</sub>	Pulsed Source Current (Body Diode) ①	—	—	100		
V <sub>SD</sub>	Diode Forward Voltage	—	—	1.3	V	T <sub>J</sub> = 25°C, I <sub>S</sub> = 15A, V <sub>GS</sub> = 0V ④
t <sub>rr</sub>	Reverse Recovery Time	—	78	—	ns	T <sub>J</sub> = 25°C V <sub>R</sub> = 100V,
		—	99	—		T <sub>J</sub> = 125°C I <sub>F</sub> = 15A
Q <sub>rr</sub>	Reverse Recovery Charge	—	294	—	nC	T <sub>J</sub> = 25°C di/dt = 100A/μs ④
		—	432	—		T <sub>J</sub> = 125°C
I <sub>RRM</sub>	Reverse Recovery Current	—	7.6	—	A	T <sub>J</sub> = 25°C
t <sub>on</sub>	Forward Turn-On Time	Intrinsic turn-on time is negligible (turn-on is dominated by LS+LD)				

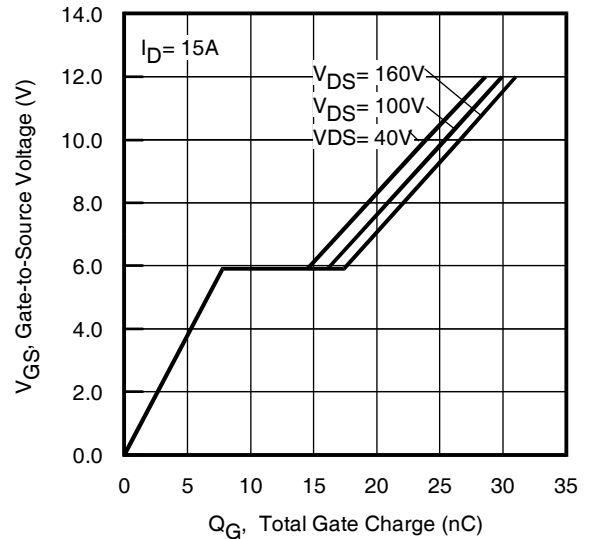
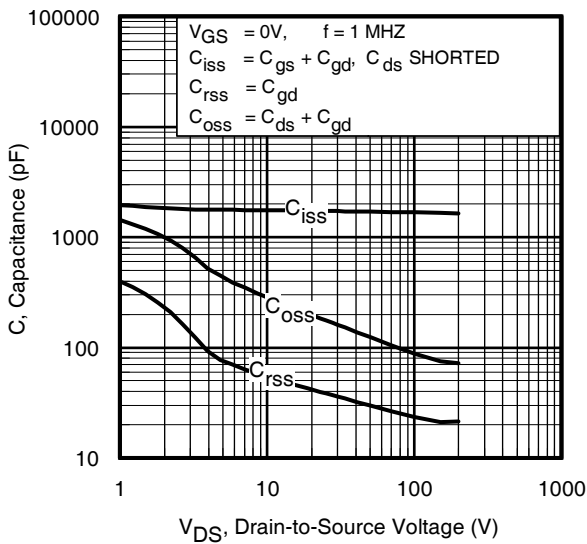
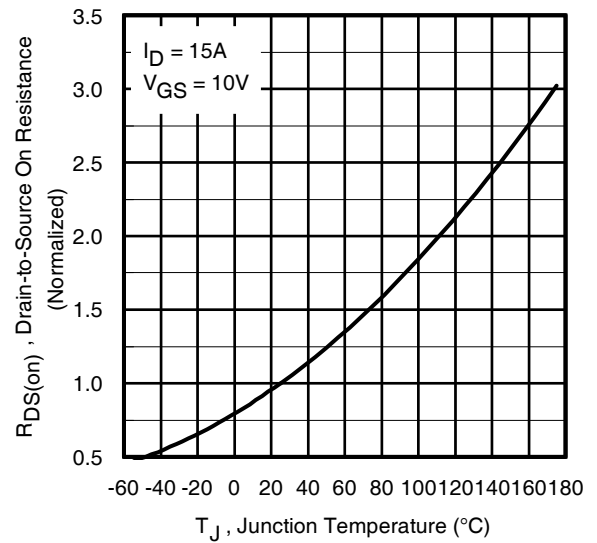
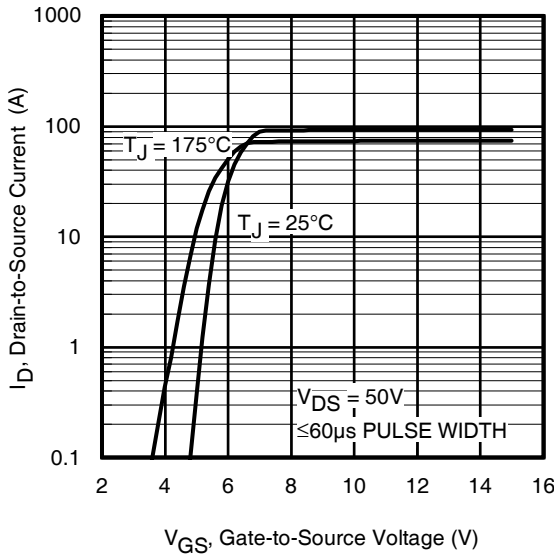
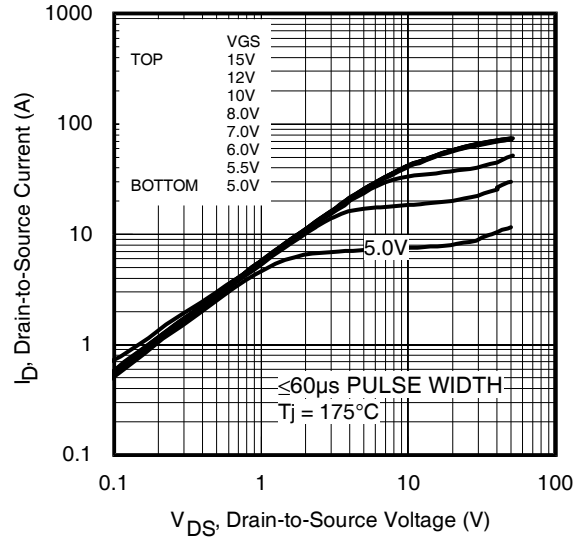
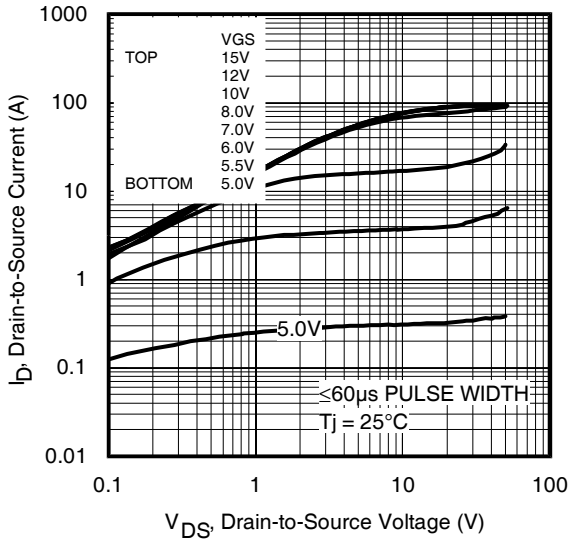
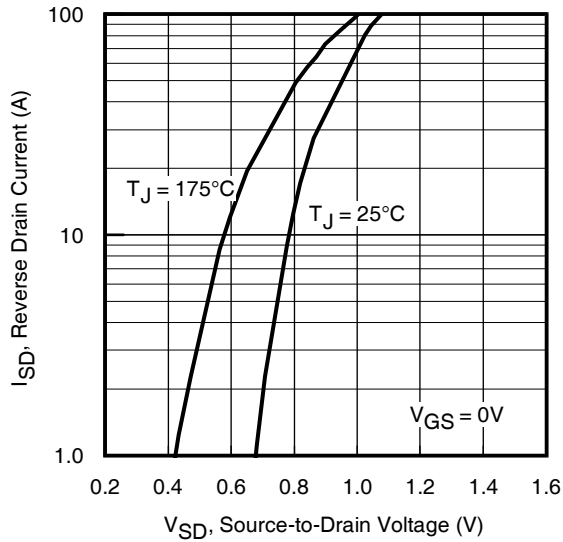
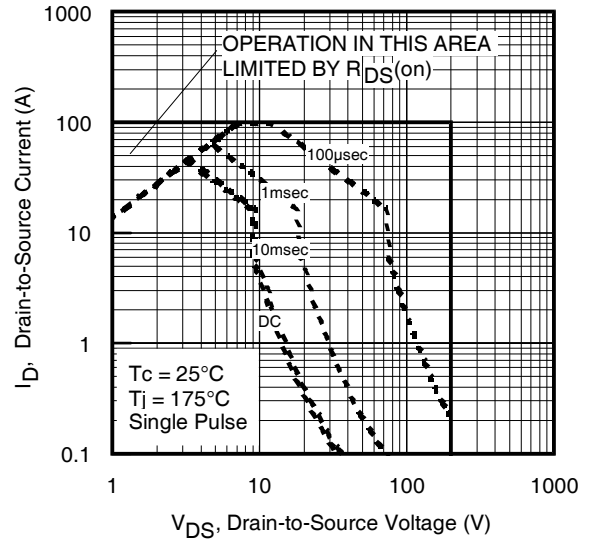

Fig 5. Typical Capacitance vs. Drain-to-Source Voltage

Fig 6. Typical Gate Charge vs. Gate-to-Source Voltage



**Fig 7.** Typical Source-Drain Diode Forward Voltage



**Fig 8.** Maximum Safe Operating Area

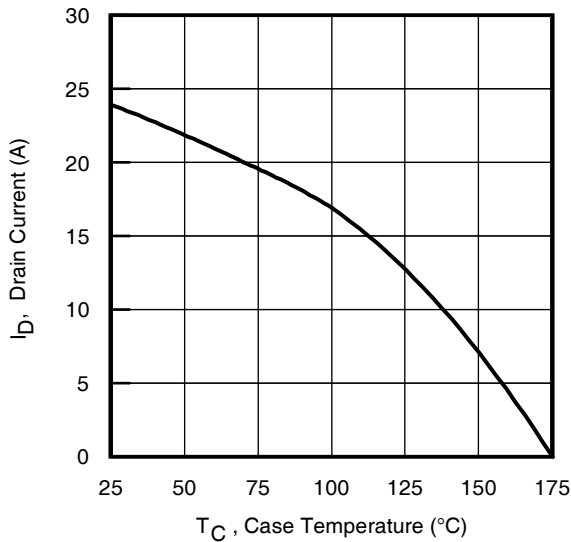

**Fig 9.** Maximum Drain Current vs. Case Temperature

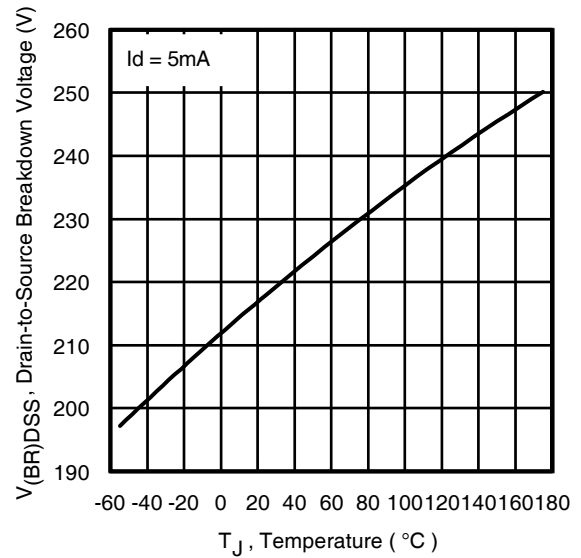

**Fig 10.** Drain-to-Source Breakdown Voltage

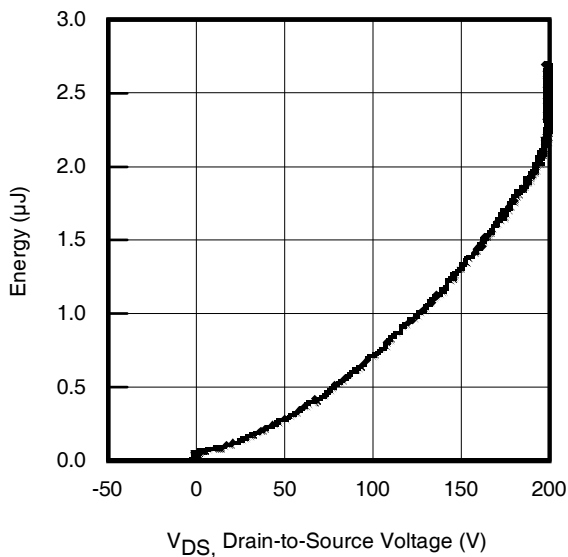

**Fig 11.** Typical  $C_{OSS}$  Stored Energy

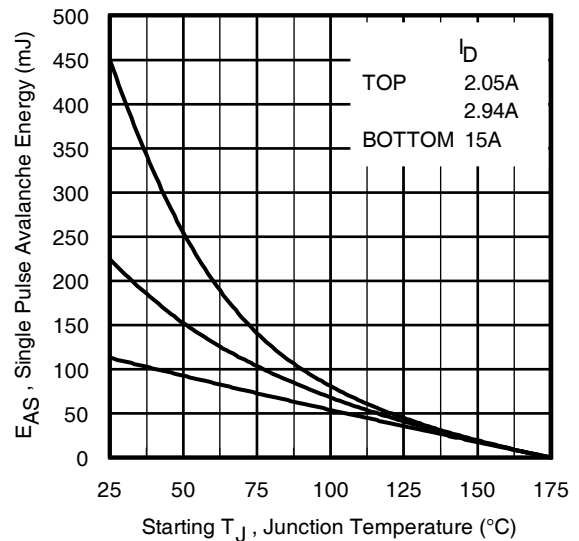

**Fig 12.** Maximum Avalanche Energy vs. Drain Current

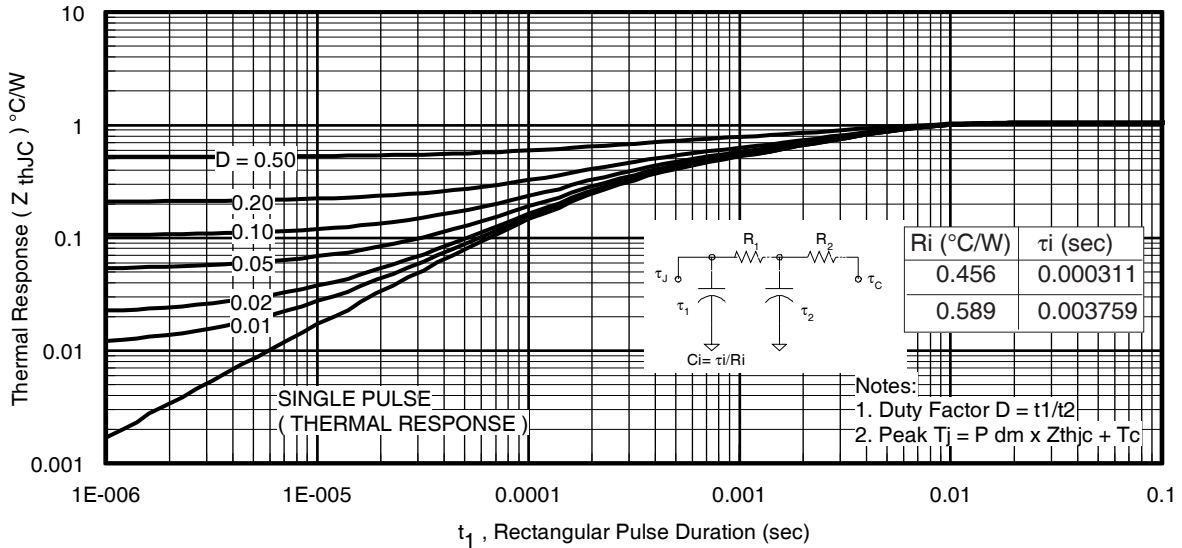

Fig 13. Maximum Effective Transient Thermal Impedance, Junction-to-Case

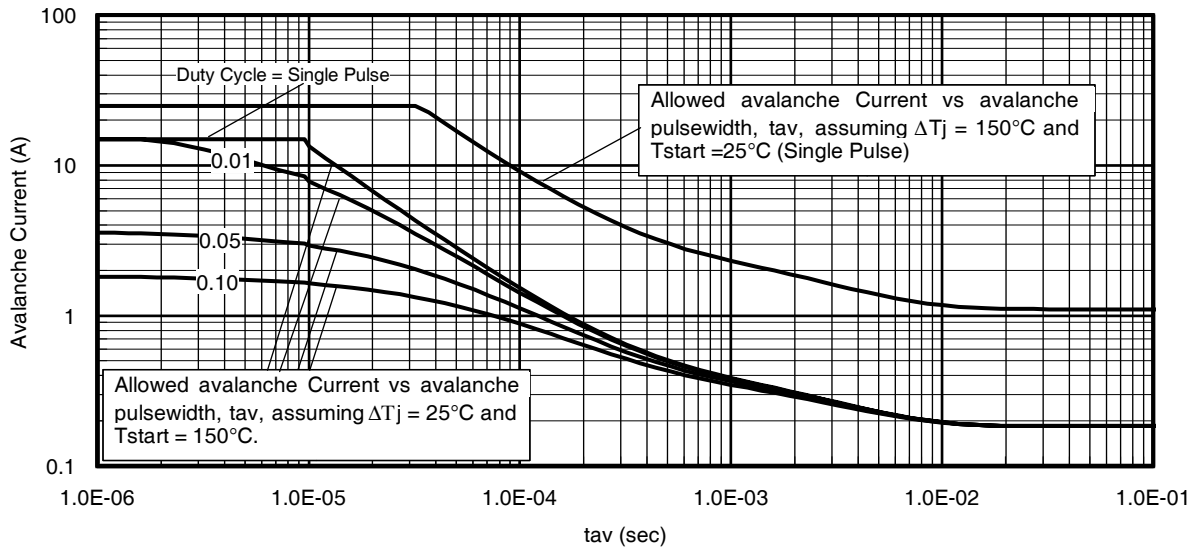
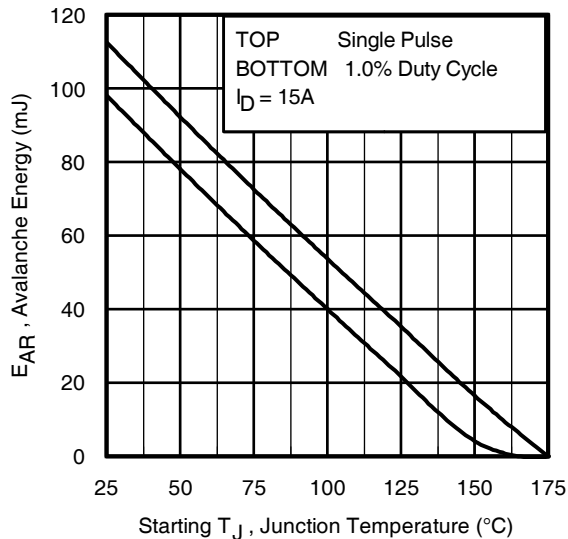

Fig 14. Typical Avalanche Current vs. Pulsewidth



Notes on Repetitive Avalanche Curves, Figures 14, 15:  
(For further info, see AN-1005 at [www.irf.com](http://www.irf.com))

1. Avalanche failures assumption:  
Purely a thermal phenomenon and failure occurs at a temperature far in excess of  $T_{jmax}$ . This is validated for every part type.
2. Safe operation in Avalanche is allowed as long as  $T_{jmax}$  is not exceeded.
3. Equation below based on circuit and waveforms shown in Figures 16a, 16b.
4.  $P_{D(ave)}$  = Average power dissipation per single avalanche pulse.
5.  $BV$  = Rated breakdown voltage (1.3 factor accounts for voltage increase during avalanche).
6.  $I_{av}$  = Allowable avalanche current.
7.  $\Delta T$  = Allowable rise in junction temperature, not to exceed  $T_{jmax}$  (assumed as 25°C in Figure 14, 15).  
 $t_{av}$  = Average time in avalanche.  
 $D$  = Duty cycle in avalanche =  $t_{av} \cdot f$   
 $Z_{thJC}(D, t_{av})$  = Transient thermal resistance, see Figures 13)

$$P_{D(ave)} = 1/2 (1.3 \cdot BV \cdot I_{av}) = \Delta T / Z_{thJC}$$

$$I_{av} = 2\Delta T / [1.3 \cdot BV \cdot Z_{th}]$$

$$E_{AS(AR)} = P_{D(ave)} \cdot t_{av}$$

Fig 15. Maximum Avalanche Energy vs. Temperature

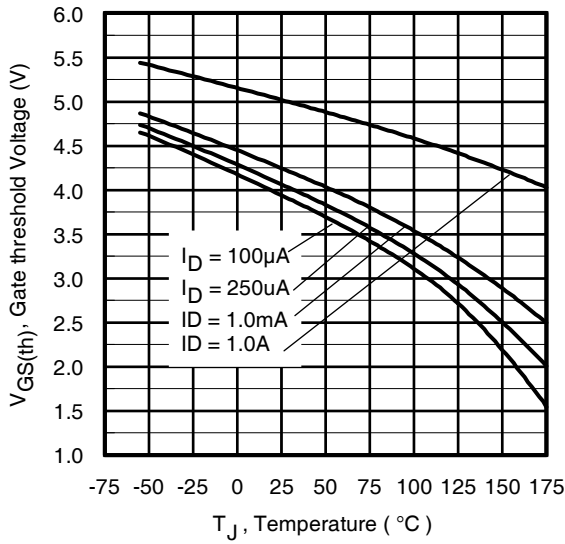

Fig 16. Threshold Voltage vs. Temperature

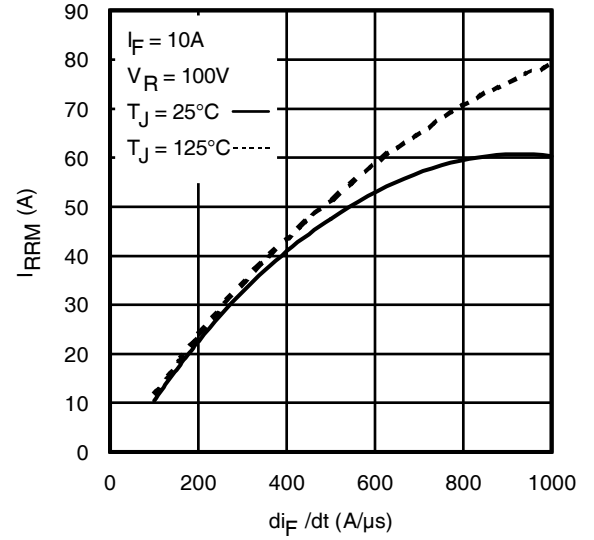

Fig. 17 - Typical Recovery Current vs. di<sub>F</sub>/dt

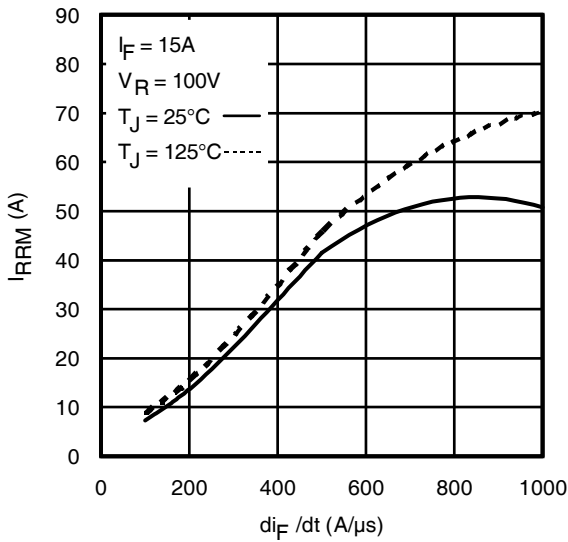

Fig. 18 - Typical Recovery Current vs. di<sub>F</sub>/dt

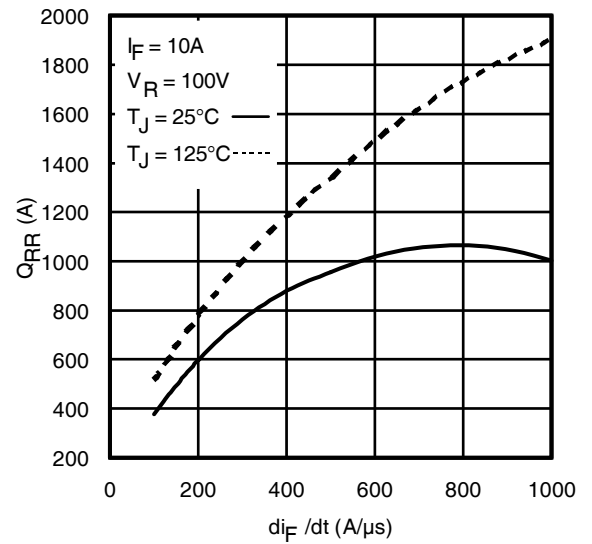

Fig. 19 - Typical Stored Charge vs. di<sub>F</sub>/dt

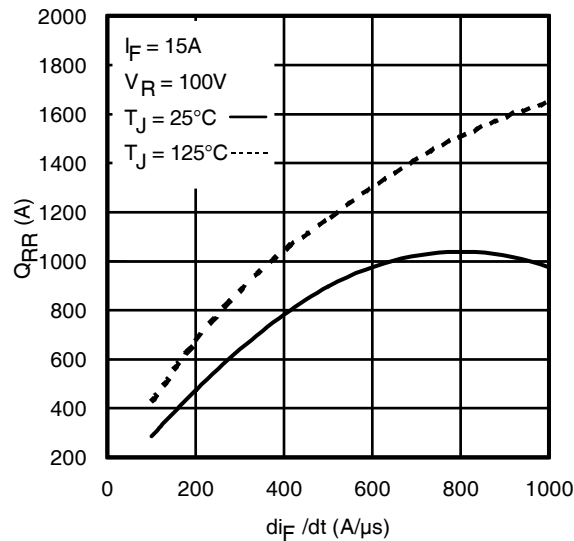

Fig. 20 - Typical Stored Charge vs. di<sub>F</sub>/dt



**Fig 21. Peak Diode Recovery dv/dt Test Circuit for N-Channel HEXFET® Power MOSFETs**



\*  $V_{GS} = 5V$  for Logic Level Devices

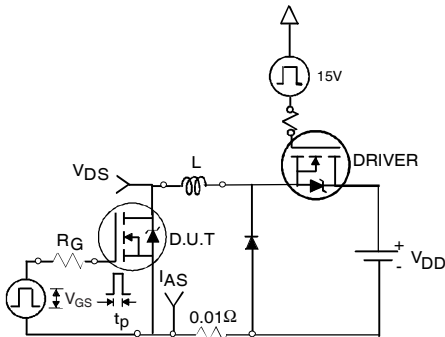

**Fig 22a. Unclamped Inductive Test Circuit**

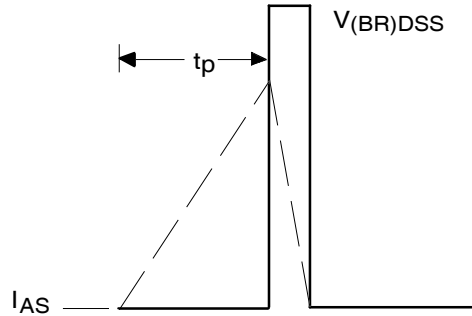

**Fig 22b. Unclamped Inductive Waveforms**

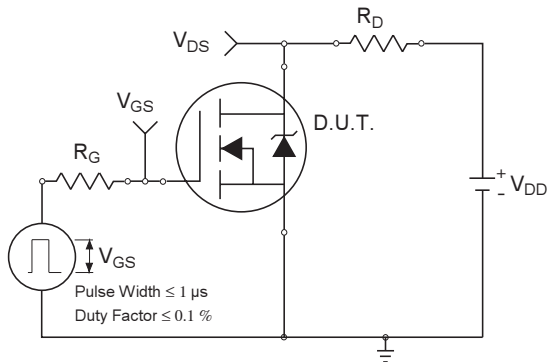

**Fig 23a. Switching Time Test Circuit**

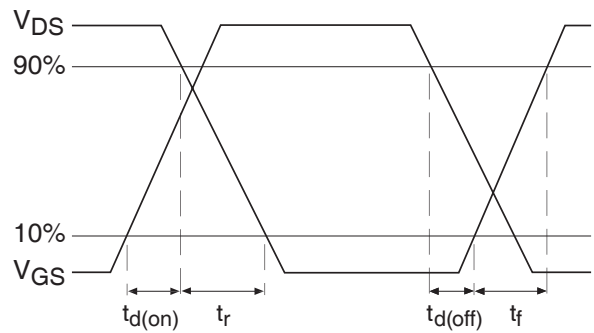

**Fig 23b. Switching Time Waveforms**

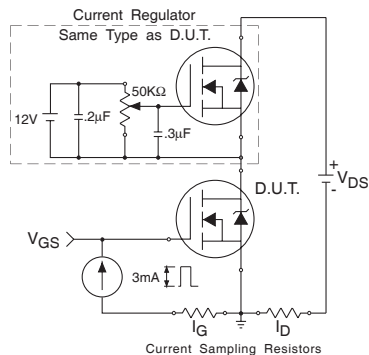

**Fig 24a. Gate Charge Test Circuit**

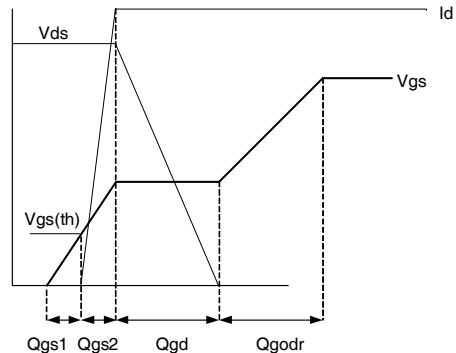

**Fig 24b. Gate Charge Waveform**

D-Pak (TO-252AA) Package Outline

Dimensions are shown in millimeters (inches)

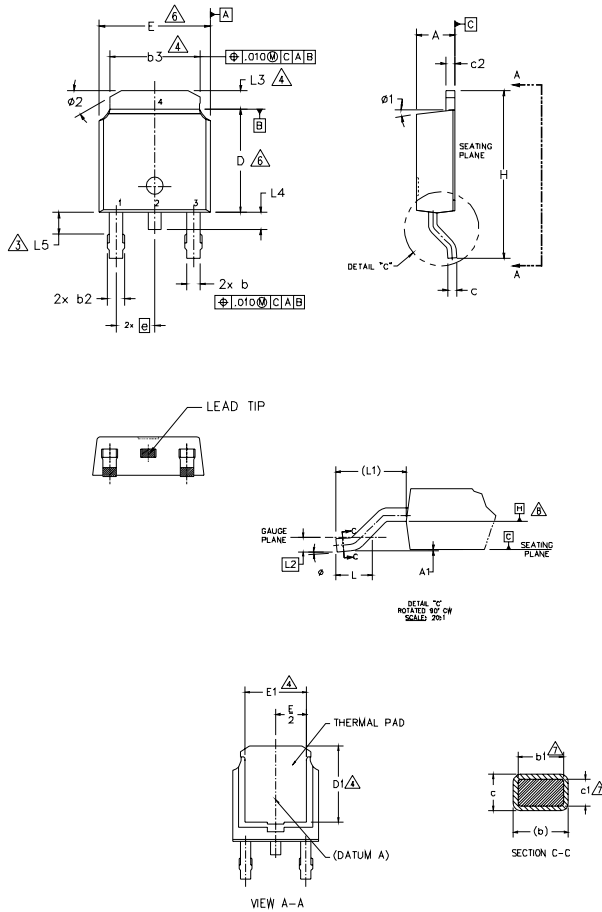

- NOTES:
- 1.- DIMENSIONING AND TOLERANCING PER ASME Y14.5M-1994
  - 2.- DIMENSIONS ARE SHOWN IN INCHES [MILLIMETERS].
  - 3.- LEAD DIMENSION UNCONTROLLED IN L5.
  - 4.- DIMENSION D1, E1, L3 & b3 ESTABLISH A MINIMUM MOUNTING SURFACE FOR THERMAL PAD.
  - 5.- SECTION C-C DIMENSIONS APPLY TO THE FLAT SECTION OF THE LEAD BETWEEN .005 AND 0.10 [0.13 AND 0.25] FROM THE LEAD TIP.
  - 6.- DIMENSION D & E DO NOT INCLUDE MOLD FLASH. MOLD FLASH SHALL NOT EXCEED .005 [0.13] PER SIDE. THESE DIMENSIONS ARE MEASURED AT THE OUTMOST EXTREMES OF THE PLASTIC BODY.
  - 7.- DIMENSION b1 & c1 APPLIED TO BASE METAL ONLY.
  - 8.- DATUM A & B TO BE DETERMINED AT DATUM PLANE H.
  - 9.- OUTLINE CONFORMS TO JEDEC OUTLINE TO-252AA.

SYMBOL	DIMENSIONS				NOTES
	MILLIMETERS		INCHES		
	MIN.	MAX.	MIN.	MAX.	
A	2.18	2.39	.086	.094	
A1	-	0.13	-	.005	
b	0.64	0.89	.025	.035	
b1	0.65	0.79	.025	.031	7
b2	0.76	1.14	.030	.045	
b3	4.95	5.46	.195	.215	4
c	0.46	0.61	.018	.024	
c1	0.41	0.56	.016	.022	7
c2	0.46	0.89	.018	.035	
D	5.97	6.22	.235	.245	6
D1	5.21	-	.205	-	4
E	6.35	6.73	.250	.265	6
E1	4.32	-	.170	-	4
e	2.29 BSC		.090 BSC		
H	9.40	10.41	.370	.410	
L	1.40	1.78	.055	.070	
L1	2.74 BSC		.108 REF.		
L2	0.51 BSC		.020 BSC		
L3	0.89	1.27	.035	.050	4
L4	-	1.02	-	.040	
L5	1.14	1.52	.045	.060	3
Ø	0"	10"	0"	10"	
Ø1	0"	15"	0"	15"	
Ø2	25"	35"	25"	35"	

LEAD ASSIGNMENTS

HEXFET

- 1.- GATE
- 2.- DRAIN
- 3.- SOURCE
- 4.- DRAIN

IGBT & CoPAK

- 1.- GATE
- 2.- COLLECTOR
- 3.- EMITTER
- 4.- COLLECTOR

D-Pak (TO-252AA) Part Marking Information

EXAMPLE: THIS IS AN IRFR120 WITH ASSEMBLY LOT CODE 1234 ASSEMBLED ON WW 16, 2001 IN THE ASSEMBLY LINE 'A'

Note: 'P' in assembly line position indicates 'Lead-Free'

'P' in assembly line position indicates 'Lead-Free' qualification to the consumer-level

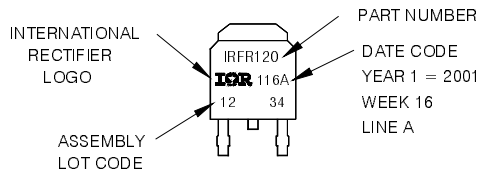

OR

INTERNATIONAL RECTIFIER LOGO

ASSEMBLY LOT CODE

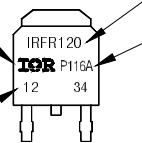

PART NUMBER

DATE CODE  
P = DESIGNATES LEAD-FREE PRODUCT (OPTIONAL)

P = DESIGNATES LEAD-FREE PRODUCT QUALIFIED TO THE CONSUMER LEVEL (OPTIONAL)

YEAR 1 = 2001

WEEK 16

A = ASSEMBLY SITE CODE

Note: For the most current drawing please refer to IR website at <http://www.irf.com/package/>



D-Pak (TO-252AA) Tape & Reel Information

Dimensions are shown in millimeters (inches)

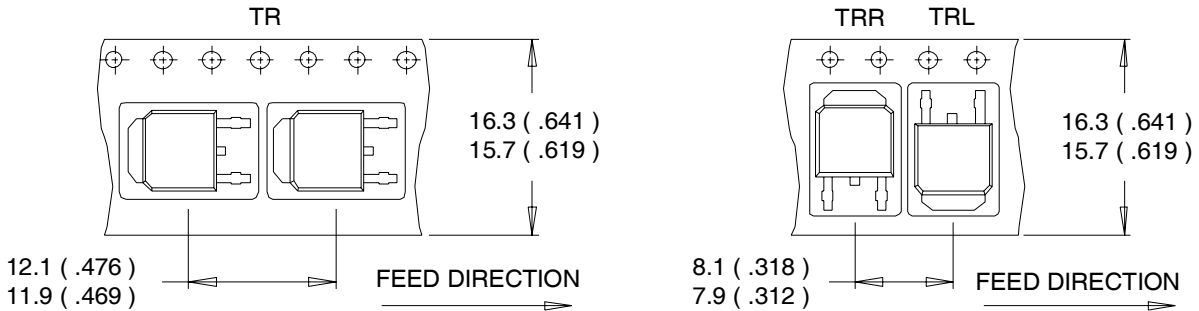

NOTES :

1. CONTROLLING DIMENSION : MILLIMETER.
2. ALL DIMENSIONS ARE SHOWN IN MILLIMETERS ( INCHES ).
3. OUTLINE CONFORMS TO EIA-481 & EIA-541.

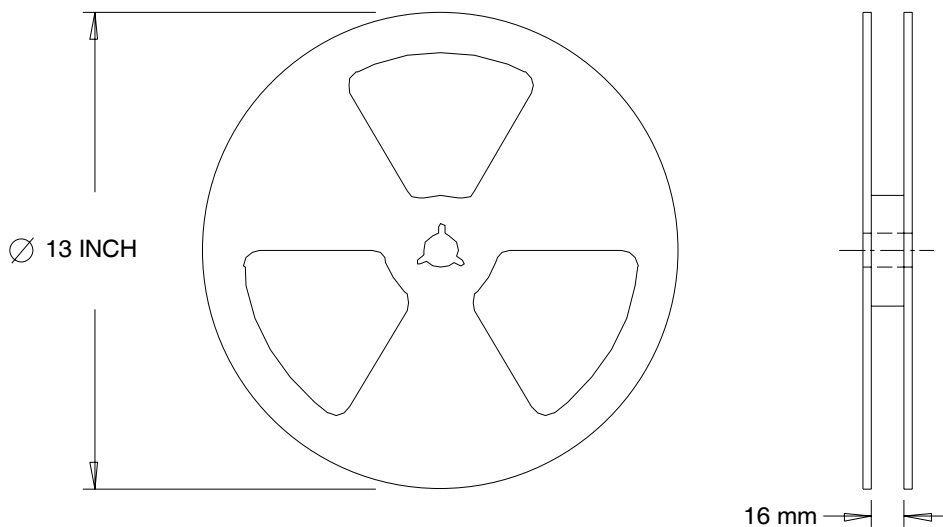

NOTES :

1. OUTLINE CONFORMS TO EIA-481.

Note: For the most current drawing please refer to IR website at <http://www.irf.com/package/>

Orderable part number	Package Type	Standard Pack		Note
		Form	Quantity	
IRFR4620PbF	D-PAK	Tube/Bulk	75	
IRFR4620TRPbF	D-PAK	Tape and Reel	2000	
IRFU4620PbF	I-PAK	Tube/Bulk	75	

### Qualification Information<sup>†</sup>

Qualification level	Industrial <sup>††</sup>	
	(per JEDEC JESD47F <sup>†††</sup> guidelines)	
	Comments: This family of products has passed JEDEC's Industrial qualification. IR's Consumer qualification level is granted by extension of the higher Industrial level.	
Moisture Sensitivity Level	D-PAK	MSL1 (per JEDEC J-STD-020D <sup>†††</sup> )
	I-PAK	Not applicable
RoHS Compliant	Yes	

† Qualification standards can be found at International Rectifier's web site <http://www.irf.com/product-info/reliability>

†† Higher qualification ratings may be available should the user have such requirements. Please contact

your International Rectifier sales representative for further information: <http://www.irf.com/whoto-call/salesrep/>

††† Applicable version of JEDEC standard at the time of product release.

#### Notes:

- ① Repetitive rating; pulse width limited by max. junction temperature.
- ② Limited by  $T_{Jmax}$ , starting  $T_J = 25^\circ\text{C}$ ,  $L = 1.0\text{mH}$   
 $R_G = 25\Omega$ ,  $I_{AS} = 15\text{A}$ ,  $V_{GS} = 10\text{V}$ . Part not recommended for use above this value.
- ③  $I_{SD} \leq 15\text{A}$ ,  $di/dt \leq 634\text{A}/\mu\text{s}$ ,  $V_{DD} \leq V_{(BR)DSS}$ ,  $T_J \leq 175^\circ\text{C}$ .
- ④ Pulse width  $\leq 400\mu\text{s}$ ; duty cycle  $\leq 2\%$ .
- ⑤  $C_{oss}$  eff. (TR) is a fixed capacitance that gives the same charging time as  $C_{oss}$  while  $V_{DS}$  is rising from 0 to 80%  $V_{DSS}$ .
- ⑥  $C_{oss}$  eff. (ER) is a fixed capacitance that gives the same energy as  $C_{oss}$  while  $V_{DS}$  is rising from 0 to 80%  $V_{DSS}$ .
- ⑦ When mounted on 1" square PCB (FR-4 or G-10 Material). For recommended footprint and soldering techniques refer to application note #AN-994.
- ⑧  $R_\theta$  is measured at  $T_J$  approximately  $90^\circ\text{C}$

Data and specifications subject to change without notice

International  
IR Rectifier

IR WORLD HEADQUARTERS: 233 Kansas St., El Segundo, California 90245, USA Tel: (310) 252-7105

TAC Fax: (310) 252-7903

Visit us at [www.irf.com](http://www.irf.com) for sales contact information. 06/2009

## **IMPORTANT NOTICE**

The information given in this document shall in no event be regarded as a guarantee of conditions or characteristics ("Beschaffheitsgarantie").

With respect to any examples, hints or any typical values stated herein and/or any information regarding the application of the product, Infineon Technologies hereby disclaims any and all warranties and liabilities of any kind, including without limitation warranties of non-infringement of intellectual property rights of any third party.

In addition, any information given in this document is subject to customer's compliance with its obligations stated in this document and any applicable legal requirements, norms and standards concerning customer's products and any use of the product of Infineon Technologies in customer's applications.

The data contained in this document is exclusively intended for technically trained staff. It is the responsibility of customer's technical departments to evaluate the suitability of the product for the intended application and the completeness of the product information given in this document with respect to such application.

For further information on the product, technology, delivery terms and conditions and prices please contact your nearest Infineon Technologies office ([www.infineon.com](http://www.infineon.com)).

## **WARNINGS**

Due to technical requirements products may contain dangerous substances. For information on the types in question please contact your nearest Infineon Technologies office.

Except as otherwise explicitly approved by Infineon Technologies in a written document signed by authorized representatives of Infineon Technologies, Infineon Technologies' products may not be used in any applications where a failure of the product or any consequences of the use thereof can reasonably be expected to result in personal injury.

## Looking for pricing, stock, or lifecycle information?

Click below to explore more details on WIN SOURCE:

 [View IRFR4620TRLPBF on WIN SOURCE](#)

 [Infineon Technologies](#) Information

## Optimize Your Supply Chain with WIN SOURCE Solutions

-  Global Sourcing Solution
-  Obsolete Management
-  Cost Control Management
-  Shortage Management
-  Alternative Solution
-  Excess Inventory Management