



THE DATASHEET OF IRFZ48NLPBF



IRFZ48NSPbF

IRFZ48NLPbF

HEXFET® Power MOSFET

- Advanced Process Technology
- Surface Mount (IRFZ48NS)
- Low-profile through-hole (IRFZ48NL)
- 175°C Operating Temperature
- Fast Switching
- Fully Avalanche Rated
- Lead-Free

Description

Advanced HEXFET® Power MOSFETs from International Rectifier utilize advanced processing techniques to achieve extremely low on-resistance per silicon area. This benefit, combined with the fast switching speed and ruggedized device design that HEXFET power MOSFETs are well known for, provides the designer with an extremely efficient and reliable device for use in a wide variety of applications.

The D²Pak is a surface mount power package capable of accommodating die sizes up to HEX-4. It provides the highest power capability and the lowest possible on-resistance in any existing surface mount package. The D²Pak is suitable for high current applications because of its low internal connection resistance and can dissipate up to 2.0W in a typical surface mount application. The through-hole version (IRFZ48NL) is available for low-profile applications.

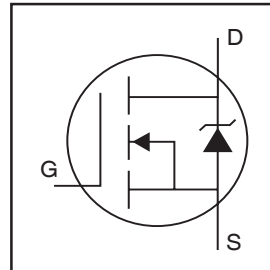

$V_{DSS} = 55V$
$R_{DS(on)} = 0.014\Omega$
$I_D = 64A$

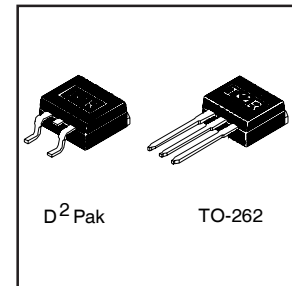

Absolute Maximum Ratings

	Parameter	Max.	Units
$I_D @ T_C = 25^\circ C$	Continuous Drain Current, $V_{GS} @ 10V$	64	A
$I_D @ T_C = 100^\circ C$	Continuous Drain Current, $V_{GS} @ 10V$	45	
I_{DM}	Pulsed Drain Current ①	210	
$P_D @ T_A = 25^\circ C$	Power Dissipation	3.8	W
$P_D @ T_C = 25^\circ C$	Power Dissipation	130	W
	Linear Derating Factor	0.83	W/°C
V_{GS}	Gate-to-Source Voltage	± 20	V
I_{AR}	Avalanche Current ①	32	A
E_{AR}	Repetitive Avalanche Energy ①	13	mJ
dv/dt	Peak Diode Recovery dv/dt ③	5.0	V/ns
T_J	Operating Junction and	-55 to + 175	°C
T_{STG}	Storage Temperature Range Soldering Temperature, for 10 seconds	300 (1.6mm from case)	

Thermal Resistance

	Parameter	Typ.	Max.	Units
R_{qJC}	Junction-to-Case	—	1.15	°C/W
R_{qJA}	Junction-to-Ambient (PCB Mounted, steady-state)**	—	40	

IRFZ48NS/LPbF

International
IR Rectifier

Electrical Characteristics @ $T_J = 25^\circ\text{C}$ (unless otherwise specified)

	Parameter	Min.	Typ.	Max.	Units	Conditions
$V_{(BR)DSS}$	Drain-to-Source Breakdown Voltage	55	—	—	V	$V_{GS} = 0V, I_D = 250\mu A$
$\Delta V_{(BR)DSS}/\Delta T_J$	Breakdown Voltage Temp. Coefficient	—	0.058	—	V/°C	Reference to $25^\circ\text{C}, I_D = 1\text{mA}$
$R_{DS(on)}$	Static Drain-to-Source On-Resistance	—	—	14	mΩ	$V_{GS} = 10V, I_D = 32A$ ④
$V_{GS(th)}$	Gate Threshold Voltage	2.0	—	4.0	V	$V_{DS} = V_{GS}, I_D = 250\mu A$
g_{fs}	Forward Transconductance	24	—	—	S	$V_{DS} = 25V, I_D = 32A$ ④
I_{DSS}	Drain-to-Source Leakage Current	—	—	25	μA	$V_{DS} = 55V, V_{GS} = 0V$
		—	—	250		$V_{DS} = 44V, V_{GS} = 0V, T_J = 150^\circ\text{C}$
I_{GSS}	Gate-to-Source Forward Leakage	—	—	100	nA	$V_{GS} = 20V$
	Gate-to-Source Reverse Leakage	—	—	-100		$V_{GS} = -20V$
Q_g	Total Gate Charge	—	—	81	nC	$I_D = 32A$
Q_{gs}	Gate-to-Source Charge	—	—	19		$V_{DS} = 44V$
Q_{gd}	Gate-to-Drain ("Miller") Charge	—	—	30		$V_{GS} = 10V$, See Fig. 6 and 13
$t_{d(on)}$	Turn-On Delay Time	—	12	—	ns	$V_{DD} = 28V$
t_r	Rise Time	—	78	—		$I_D = 32A$
$t_{d(off)}$	Turn-Off Delay Time	—	34	—		$R_G = 0.85\Omega$
t_f	Fall Time	—	50	—		$V_{GS} = 10V$, See Fig. 10 ④
L_S	Internal Source Inductance	—	7.5	—	nH	Between lead, and center of die contact
C_{iss}	Input Capacitance	—	1970	—	pF	$V_{GS} = 0V$
C_{oss}	Output Capacitance	—	470	—		$V_{DS} = 25V$
C_{rss}	Reverse Transfer Capacitance	—	120	—		$f = 1.0\text{MHz}$, See Fig. 5
E_{AS}	Single Pulse Avalanche Energy ②	—	700 ⑤	190 ⑥	mJ	$I_{AS} = 32A, L = 0.37\text{mH}$

Source-Drain Ratings and Characteristics

	Parameter	Min.	Typ.	Max.	Units	Conditions
I_S	Continuous Source Current (Body Diode)	—	—	64	A	MOSFET symbol showing the integral reverse p-n junction diode.
I_{SM}	Pulsed Source Current (Body Diode) ①	—	—	210		
V_{SD}	Diode Forward Voltage	—	—	1.3	V	$T_J = 25^\circ\text{C}, I_S = 32A, V_{GS} = 0V$ ④
t_{rr}	Reverse Recovery Time	—	68	100	ns	$T_J = 25^\circ\text{C}, I_F = 32A$
Q_{rr}	Reverse Recovery Charge	—	220	330	nC	$di/dt = 100A/\mu s$ ④
t_{on}	Forward Turn-On Time	Intrinsic turn-on time is negligible (turn-on is dominated by $L_S + L_D$)				

Notes:

- ① Repetitive rating; pulse width limited by max. junction temperature. (See fig. 11)
- ② Starting $T_J = 25^\circ\text{C}, L = 0.37\text{mH}$
 $R_G = 25\Omega, I_{AS} = 32A$. (See Figure 12)
- ③ $I_{SD} \leq 32A, di/dt \leq 220A/\mu s, V_{DD} \leq V_{(BR)DSS}, T_J \leq 175^\circ\text{C}$
- ④ Pulse width $\leq 400\mu s$; duty cycle $\leq 2\%$.
- ⑤ This is the destructive value not limited to the thermal limit.
- ⑥ This is the thermal limited value.

** When mounted on 1" square PCB (FR-4 or G-10 Material).
For recommended soldering techniques refer to application note #AN-994.

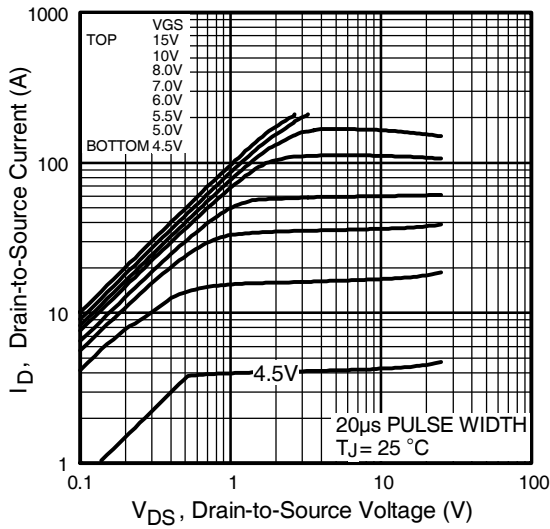

Fig 1. Typical Output Characteristics

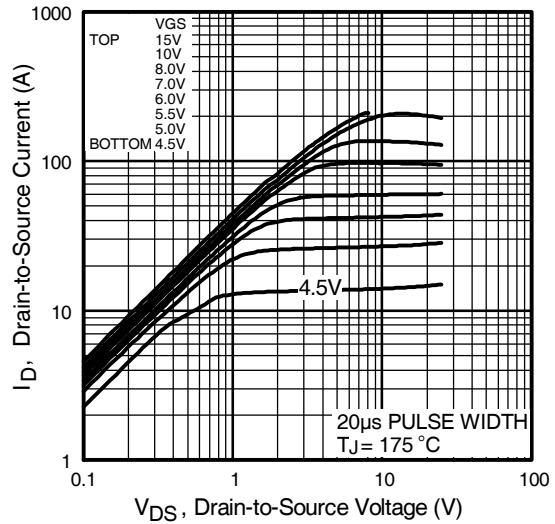

Fig 2. Typical Output Characteristics

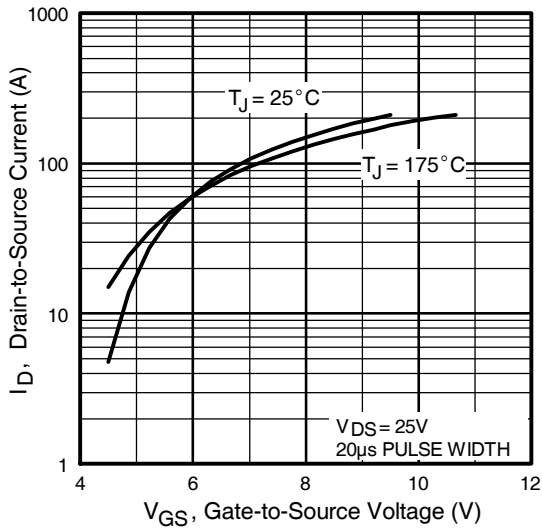

Fig 3. Typical Transfer Characteristics

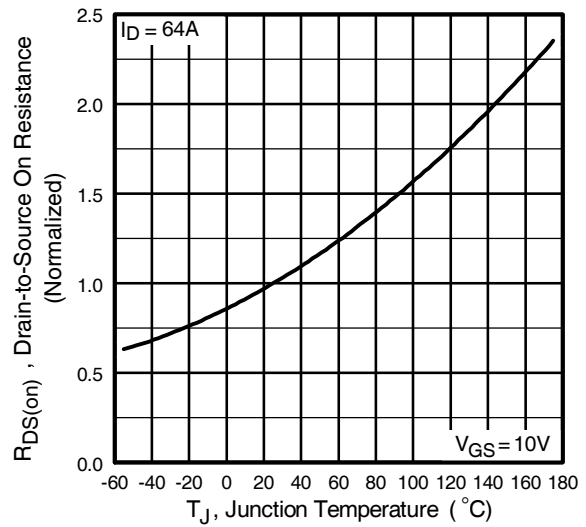

Fig 4. Normalized On-Resistance Vs. Temperature

IRFZ48NS/LPbF

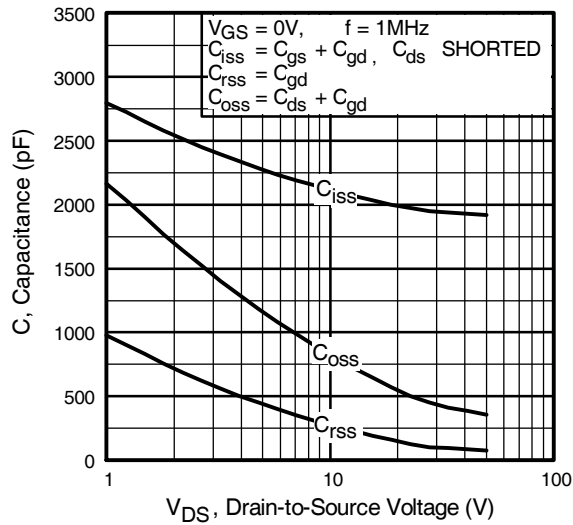

Fig 5. Typical Capacitance Vs. Drain-to-Source Voltage

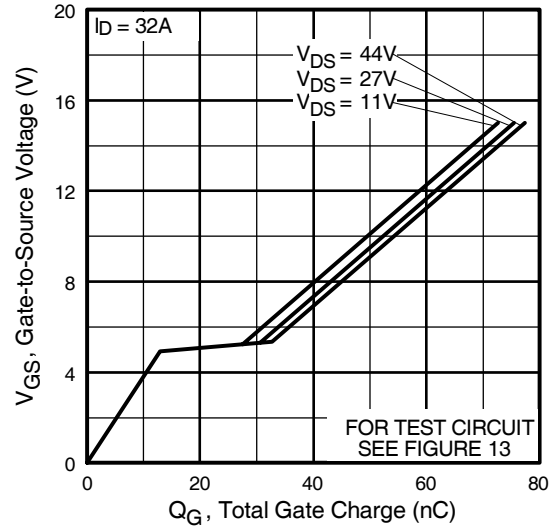

Fig 6. Typical Gate Charge Vs. Gate-to-Source Voltage

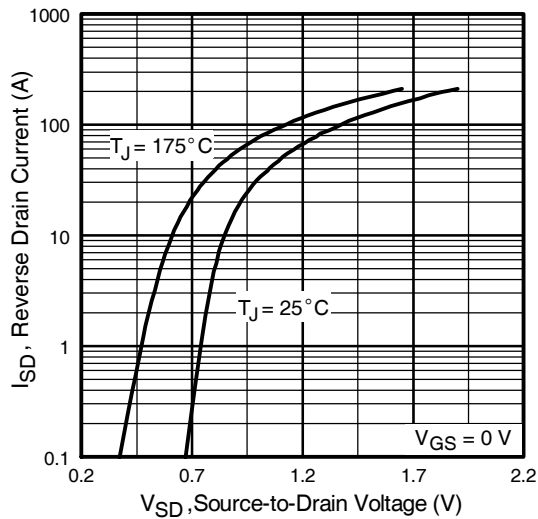

Fig 7. Typical Source-Drain Diode Forward Voltage

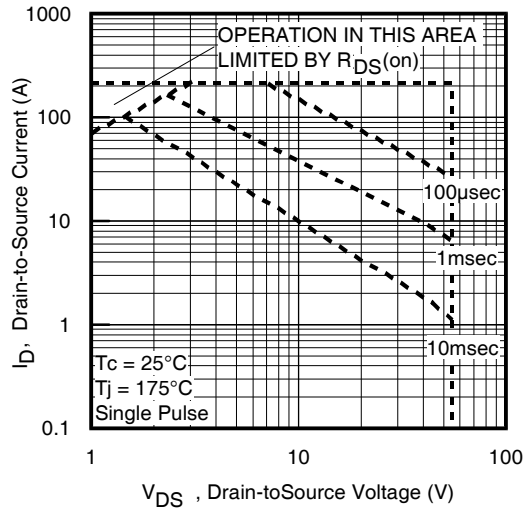

Fig 8. Maximum Safe Operating Area

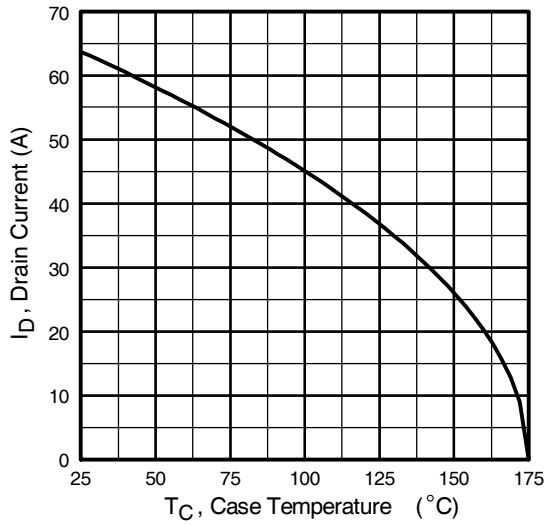

Fig 9. Maximum Drain Current Vs. Case Temperature

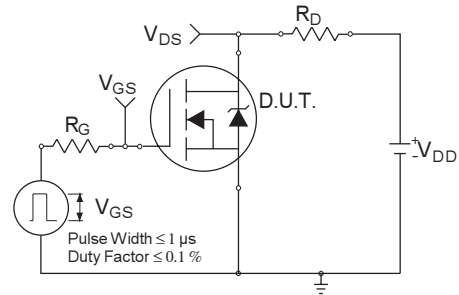

Fig 10a. Switching Time Test Circuit

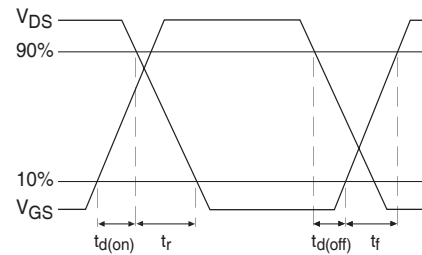

Fig 10b. Switching Time Waveforms

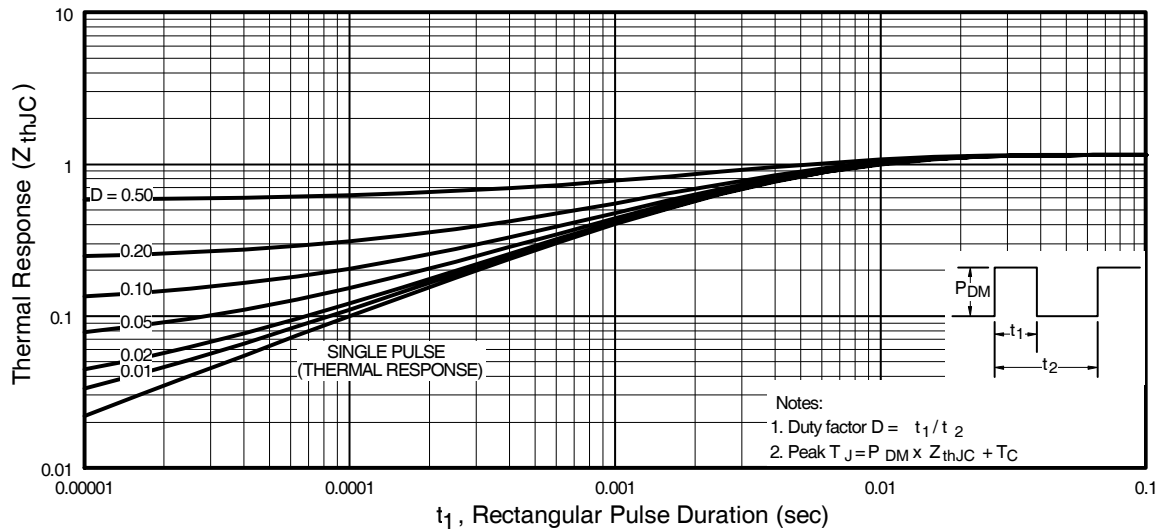

Fig 11. Maximum Effective Transient Thermal Impedance, Junction-to-Case

IRFZ48NS/LPbF

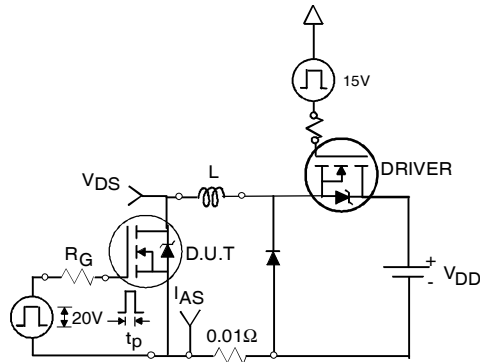

Fig 12a. Unclamped Inductive Test Circuit

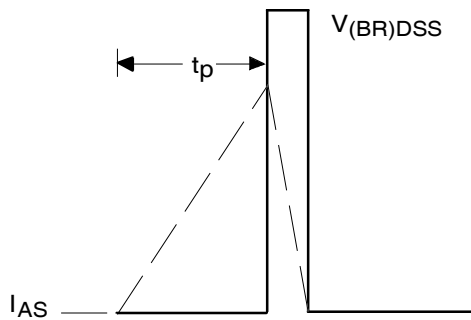

Fig 12b. Unclamped Inductive Waveforms

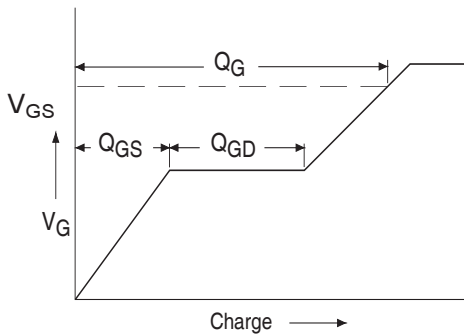

Fig 13a. Basic Gate Charge Waveform

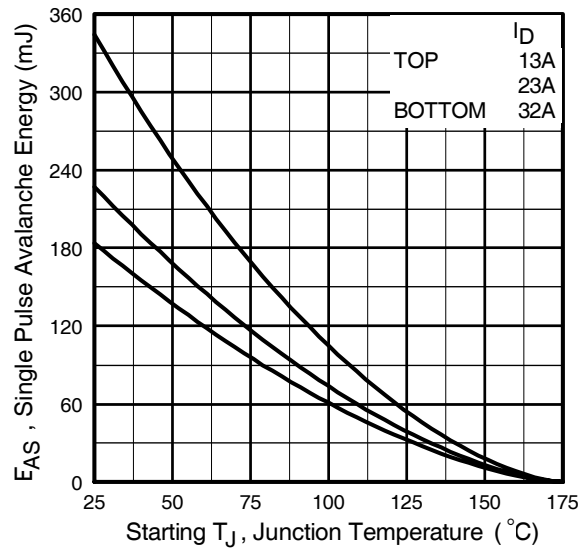

Fig 12c. Maximum Avalanche Energy Vs. Drain Current

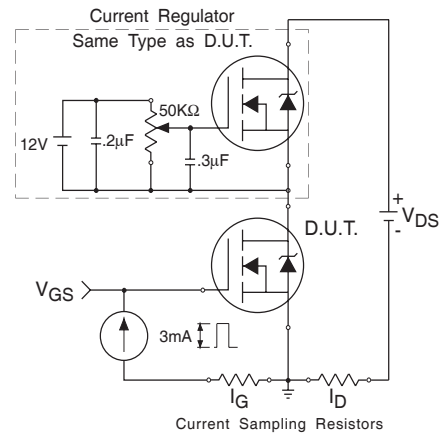
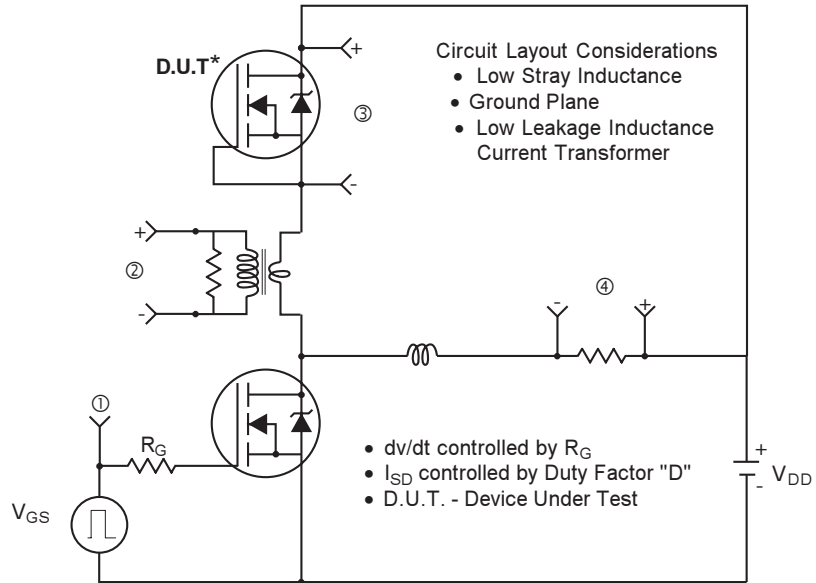
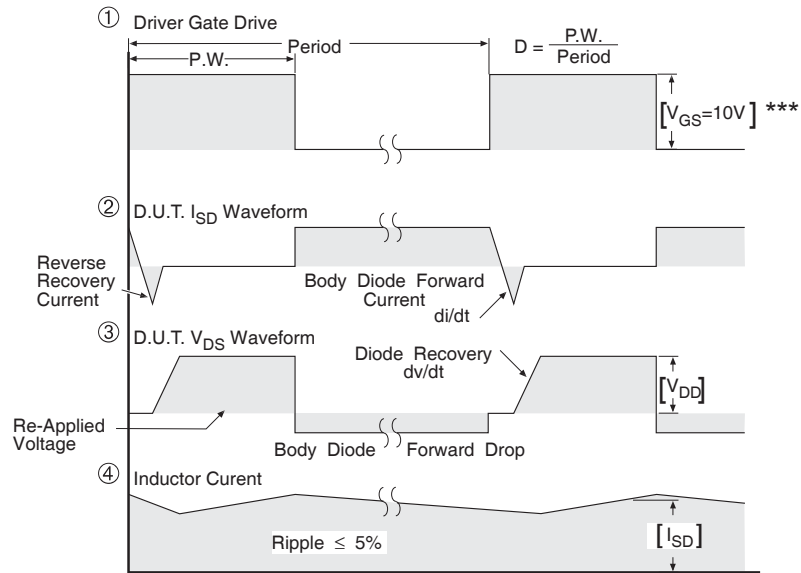

Fig 13b. Gate Charge Test Circuit

Peak Diode Recovery dv/dt Test Circuit



* Reverse Polarity of D.U.T for P-Channel



*** $V_{GS} = 5.0V$ for Logic Level and 3V Drive Devices

Fig 14. For N-channel HEXFET® power MOSFETs

IRFZ48NS/LPbF



D²Pak Package Outline

Dimensions are shown in millimeters (inches)

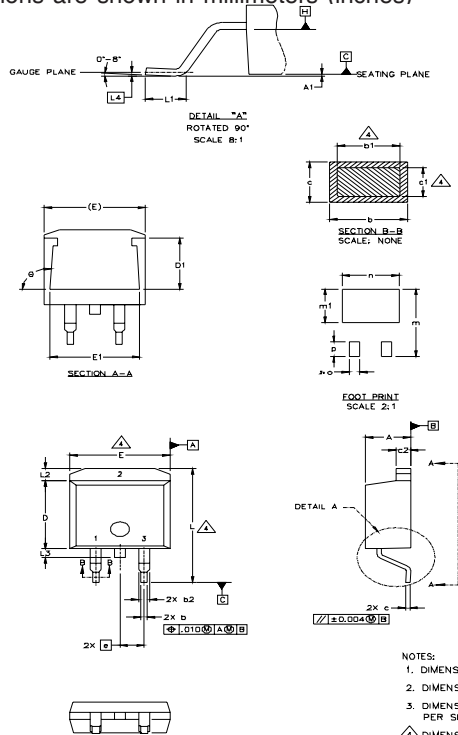

SYMBOL	DIMENSIONS				NOTES
	MILLIMETERS		INCHES		
	MIN.	MAX.	MIN.	MAX.	
A	4.06	4.83	.160	.190	4
A1		0.127		.005	
b	0.51	0.99	.020	.039	
b1	0.51	0.89	.020	.035	
b2	1.14	1.40	.045	.055	4
c	0.43	0.63	.017	.025	
c1	0.38	0.74	.015	.029	3
c2	1.14	1.40	.045	.055	
D	8.51	9.65	.335	.380	3
D1	5.33		.210		
E	9.65	10.67	.380	.420	3
E1	6.22		.245		
e	2.54	BSC	.100	BSC	
L	14.61	15.88	.575	.625	
L1	1.78	2.79	.070	.110	
L2		1.65		.065	
L3	1.27	1.78	.050	.070	
L4	0.25	BSC	.010	BSC	
m	17.78		.700		
m1	8.89		.350		
n	11.43		.450		
o	2.08		.082		
p	3.81		.150		
θ	90°	93°	90°	93°	

LEAD ASSIGNMENTS

HEXFET	IGBTs, CoPACK	DIODES
1.- GATE	1.- GATE	1.- ANODE *
2.- DRAIN	2.- COLLECTOR	2.- CATHODE
3.- SOURCE	3.- EMITTER	3.- ANODE

* PART DEPENDENT.

- NOTES:
 1. DIMENSIONING AND TOLERANCING PER ASME Y14.5M-1994
 2. DIMENSIONS ARE SHOWN IN MILLIMETERS [INCHES].
 3. DIMENSION D & E DO NOT INCLUDE MOLD FLASH. MOLD FLASH SHALL NOT EXCEED 0.127 [.005"] PER SIDE. THESE DIMENSIONS ARE MEASURED AT THE OUTMOST EXTREMES OF THE PLASTIC BODY.
 4. DIMENSION b1 AND c1 APPLY TO BASE METAL ONLY.
 5. CONTROLLING DIMENSION: INCH.

D²Pak Part Marking Information (Lead-Free)

EXAMPLE: THIS IS AN IRF530S WITH
 LOT CODE 8024
 ASSEMBLED ON WW 02, 2000
 IN THE ASSEMBLY LINE "L"

Note: "P" in assembly line
 position indicates "Lead-Free"

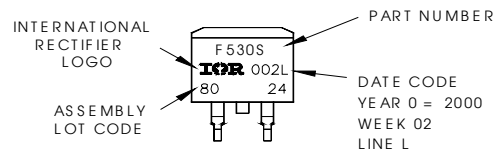

OR

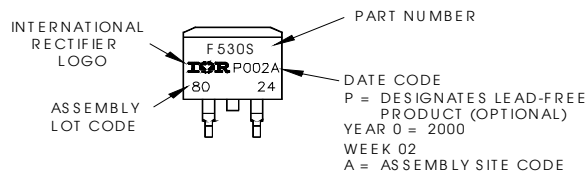

TO-262 Package Outline

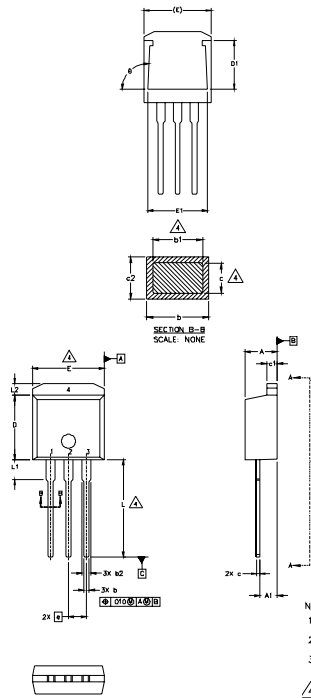

SYMBOL	DIMENSIONS				NOTES
	MILLIMETERS		INCHES		
	MIN.	MAX.	MIN.	MAX.	
A	4.06	4.83	.160	.190	4
A1	2.03	2.92	.080	.115	
b	0.51	0.99	.020	.039	
b1	0.51	0.89	.020	.035	
b2	1.14	1.40	.045	.055	4
c	0.38	0.63	.015	.025	
c1	1.14	1.40	.045	.055	3
c2	0.43	.063	.017	.029	
D	8.51	9.65	.335	.380	
D1	5.33		.210		
E	9.65	10.67	.380	.420	3
E1	6.22		.245		
e	2.54 BSC		.100 BSC		
L	13.46	14.09	.530	.555	
L1	3.56	3.71	.140	.146	
L2		1.65		.065	

LEAD ASSIGNMENTS

HEXFET	IGBT
1.- GATE	1- GATE
2.- DRAIN	2- COLLECTOR
3.- SOURCE	3- EMITTER
4.- DRAIN	

- NOTES:
1. DIMENSIONING AND TOLERANCING PER ASME Y14.5M-1994
 2. DIMENSIONS ARE SHOWN IN MILLIMETERS [INCHES]
 3. DIMENSION D & E DO NOT INCLUDE MOLD FLASH. MOLD FLASH SHALL NOT EXCEED 0.127 [0.005] PER SIDE. THESE DIMENSIONS ARE MEASURED AT THE OUTMOST EXTREMES OF THE PLASTIC BODY.
 4. DIMENSION b1 AND c1 APPLY TO BASE METAL ONLY.
 5. CONTROLLING DIMENSION: INCH.

TO-262 Part Marking Information

EXAMPLE: THIS IS AN IRL3103L
 LOT CODE 1789
 ASSEMBLED ON WW 19, 1997
 IN THE ASSEMBLY LINE "C"
 Note: "P" in assembly line
 position indicates "Lead-Free"

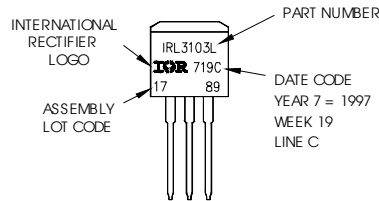

OR

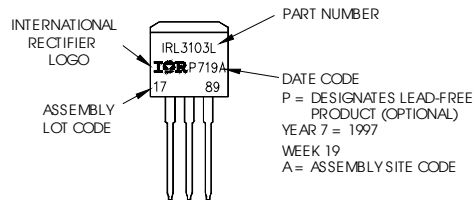

IRFZ48NS/LPbF

International
IR Rectifier

D²Pak Tape & Reel Information

Dimensions are shown in millimeters (inches)

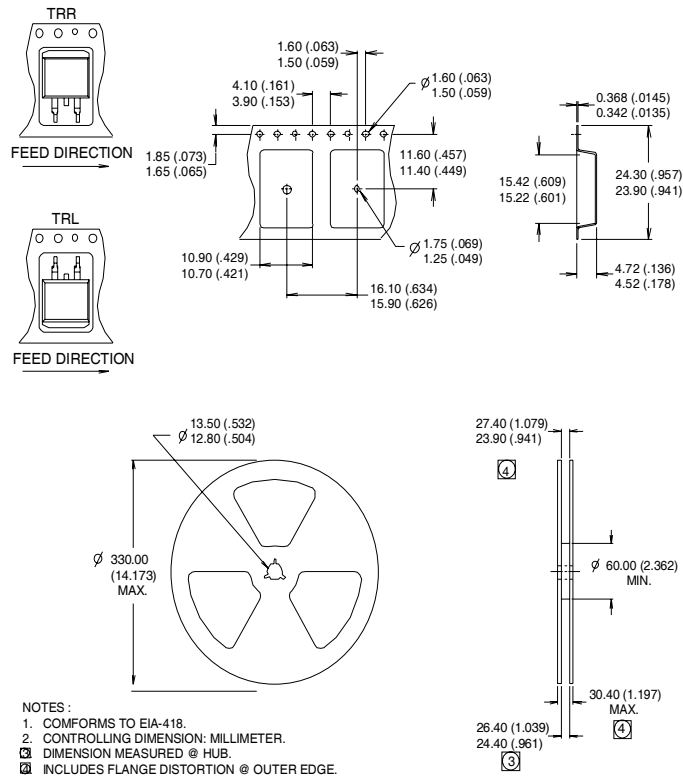

Data and specifications subject to change without notice.
This product has been designed and qualified for the industrial market.
Qualification Standards can be found on IR's Web site.

International
IR Rectifier

IR WORLD HEADQUARTERS: 233 Kansas St., El Segundo, California 90245, USA Tel: (310) 252-7105
TAC Fax: (310) 252-7903

Visit us at www.irf.com for sales contact information.03/04

www.irf.com

Note: For the most current drawings please refer to the IR website at:
<http://www.irf.com/package/>

Looking for pricing, stock, or lifecycle information?

Click below to explore more details on WIN SOURCE:

 [View IRFZ48NLPBF on WIN SOURCE](#)

 [Infineon Technologies](#) Information

Optimize Your Supply Chain with WIN SOURCE Solutions

-  Global Sourcing Solution
-  Obsolete Management
-  Cost Control Management
-  Shortage Management
-  Alternative Solution
-  Excess Inventory Management