



**THE DATASHEET OF
IRL1104S**



PRELIMINARY

IRL1104S/L

HEXFET® Power MOSFET

- Logic-Level Gate Drive
- Advanced Process Technology
- Surface Mount (IRL1104S)
- Low-profile through-hole (IRL1104L)
- 175°C Operating Temperature
- Fast Switching
- Fully Avalanche Rated

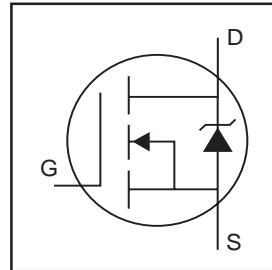

$V_{DSS} = 40V$
$R_{DS(on)} = 0.008\Omega$
$I_D = 104A\text{⑥}$

Description

Fifth Generation HEXFETs from International Rectifier utilize advanced processing techniques to achieve extremely low on-resistance per silicon area. This benefit, combined with the fast switching speed and ruggedized device design that HEXFET Power MOSFETs are well known for, provides the designer with an extremely efficient and reliable device for use in a wide variety of applications.

The D²Pak is a surface mount power package capable of accommodating die sizes up to HEX-4. It provides the highest power capability and the lowest possible on-resistance in any existing surface mount package. The D²Pak is suitable for high current applications because of its low internal connection resistance and can dissipate up to 2.0W in a typical surface mount application.

The through-hole version (IRL1104L) is available for low-profile applications.

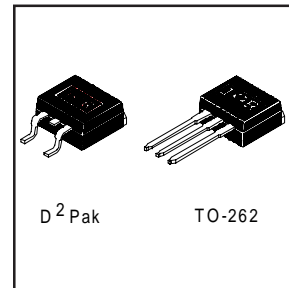

Absolute Maximum Ratings

	Parameter	Max.	Units
$I_D @ T_C = 25^\circ C$	Continuous Drain Current, $V_{GS} @ 10V\text{⑤}$	104⑥	A
$I_D @ T_C = 100^\circ C$	Continuous Drain Current, $V_{GS} @ 10V\text{⑤}$	74⑥	
I_{DM}	Pulsed Drain Current ①⑤	416	
$P_D @ T_A = 25^\circ C$	Power Dissipation	2.4	W
$P_D @ T_C = 25^\circ C$	Power Dissipation	167	W
	Linear Derating Factor	1.1	W/°C
V_{GS}	Gate-to-Source Voltage	± 16	V
E_{AS}	Single Pulse Avalanche Energy②⑤	340	mJ
I_{AR}	Avalanche Current①	62	A
E_{AR}	Repetitive Avalanche Energy①	17	mJ
dv/dt	Peak Diode Recovery dv/dt ③⑤	5.0	V/ns
T_J	Operating Junction and	-55 to + 175	°C
T_{STG}	Storage Temperature Range		
	Soldering Temperature, for 10 seconds	300 (1.6mm from case)	

Thermal Resistance

	Parameter	Typ.	Max.	Units
$R_{\theta JC}$	Junction-to-Case	—	0.9	°C/W
$R_{\theta JA}$	Junction-to-Ambient(PCB Mounted, steady-state)**	—	62	

Electrical Characteristics @ T_J = 25°C (unless otherwise specified)

	Parameter	Min.	Typ.	Max.	Units	Conditions
V _{(BR)DSS}	Drain-to-Source Breakdown Voltage	40	—	—	V	V _{GS} = 0V, I _D = 250μA
ΔV _{(BR)DSS/ΔT_J}	Breakdown Voltage Temp. Coefficient	—	0.04	—	V/°C	Reference to 25°C, I _D = 1mA ^⑤
R _{DS(on)}	Static Drain-to-Source On-Resistance	—	—	0.008	W	V _{GS} = 10V, I _D = 62A ^④
		—	—	0.012		V _{GS} = 4.5V, I _D = 52A ^④
V _{GS(th)}	Gate Threshold Voltage	1.0	—	—	V	V _{DS} = V _{GS} , I _D = 250μA
g _{fs}	Forward Transconductance	53	—	—	S	V _{DS} = 25V, I _D = 62A ^⑤
I _{DSS}	Drain-to-Source Leakage Current	—	—	25	μA	V _{DS} = 40V, V _{GS} = 0V
		—	—	250		V _{DS} = 32V, V _{GS} = 0V, T _J = 150°C
I _{GSS}	Gate-to-Source Forward Leakage	—	—	100	nA	V _{GS} = 16V
	Gate-to-Source Reverse Leakage	—	—	-100		V _{GS} = -16V
Q _g	Total Gate Charge	—	—	68	nC	I _D = 62A
Q _{gs}	Gate-to-Source Charge	—	—	24		V _{DS} = 32V
Q _{gd}	Gate-to-Drain ("Miller") Charge	—	—	34		V _{GS} = 4.5V, See Fig. 6 and 13 ^{④⑤}
t _{d(on)}	Turn-On Delay Time	—	18	—		V _{DD} = 20V
t _r	Rise Time	—	257	—		I _D = 54A
t _{d(off)}	Turn-Off Delay Time	—	32	—		R _G = 3.6Ω, V _{GS} = 4.5V
t _f	Fall Time	—	64	—		R _D = 0.4Ω, See Fig. 10 ^{④⑤}
L _S	Internal Source Inductance	—	7.5	—	nH	Between lead, and center of die contact
C _{iss}	Input Capacitance	—	3445	—	pF	V _{GS} = 0V
C _{oss}	Output Capacitance	—	1065	—		V _{DS} = 25V
C _{rss}	Reverse Transfer Capacitance	—	270	—		f = 1.0MHz, See Fig. 5 ^⑤

Source-Drain Ratings and Characteristics

	Parameter	Min.	Typ.	Max.	Units	Conditions
I _S	Continuous Source Current (Body Diode)	—	—	104 ^⑥	A	MOSFET symbol showing the integral reverse p-n junction diode.
I _{SM}	Pulsed Source Current (Body Diode) ^①	—	—	416		
V _{SD}	Diode Forward Voltage	—	—	1.3	V	T _J = 25°C, I _S = 62A, V _{GS} = 0V ^④
t _{rr}	Reverse Recovery Time	—	84	126	ns	T _J = 25°C, I _F = 62A
Q _{rr}	Reverse Recovery Charge	—	223	335	nC	di/dt = 100A/μs ^{④⑤}
t _{on}	Forward Turn-On Time	Intrinsic turn-on time is negligible (turn-on is dominated by L _S +L _D)				

Notes:

- ① Repetitive rating; pulse width limited by max. junction temperature. (See fig. 11)
- ② V_{DD} = 15V, starting T_J = 25°C, L = 0.18mH, R_G = 25Ω, I_{AS} = 62A. (See Figure 12)
- ③ I_{SD} ≤ 62A, di/dt ≤ 217A/μs, V_{DD} ≤ V_{(BR)DSS}, T_J ≤ 175°C

④ Pulse width ≤ 300μs; duty cycle ≤ 2%.

⑤ Uses IRL1104 data and test conditions.

⑥ Calculated continuous current based on maximum allowable junction temperature; for recommended current-handling of the package refer to Design Tip # 93-4

** When mounted on 1" square PCB (FR-4 or G-10 Material).
For recommended footprint and soldering techniques refer to application note #AN-994.

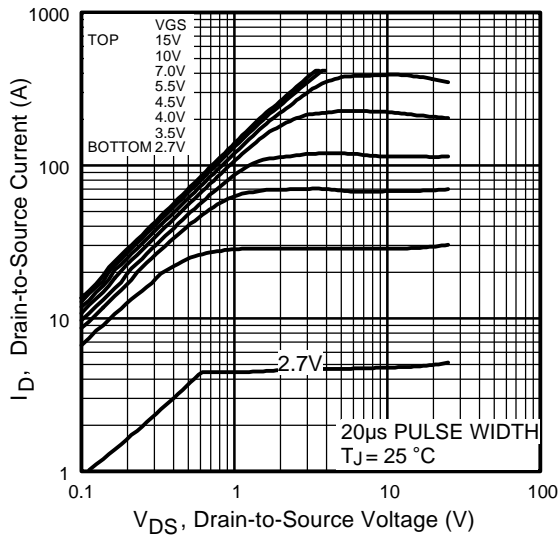

Fig 1. Typical Output Characteristics

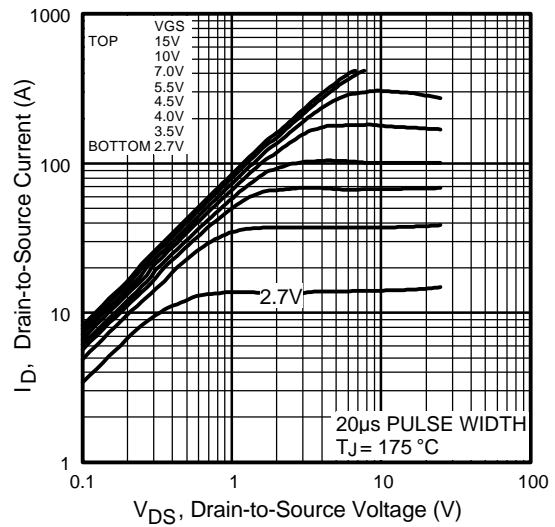

Fig 2. Typical Output Characteristics

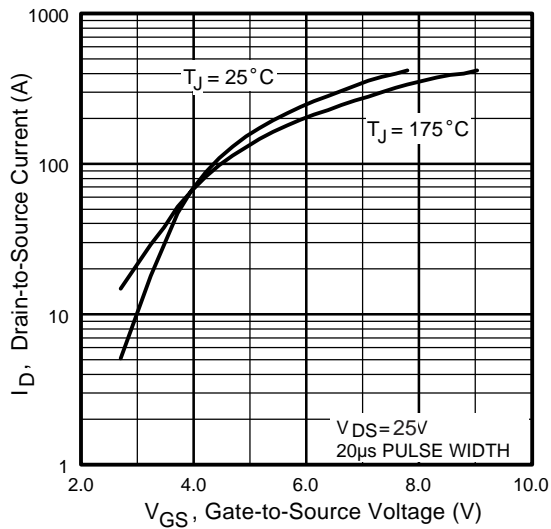

Fig 3. Typical Transfer Characteristics

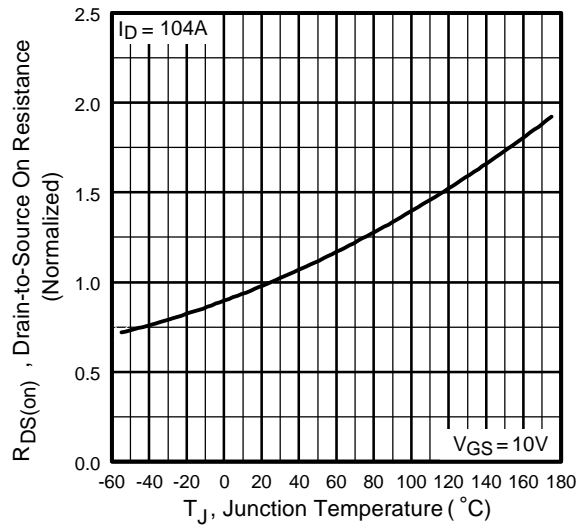

Fig 4. Normalized On-Resistance Vs. Temperature

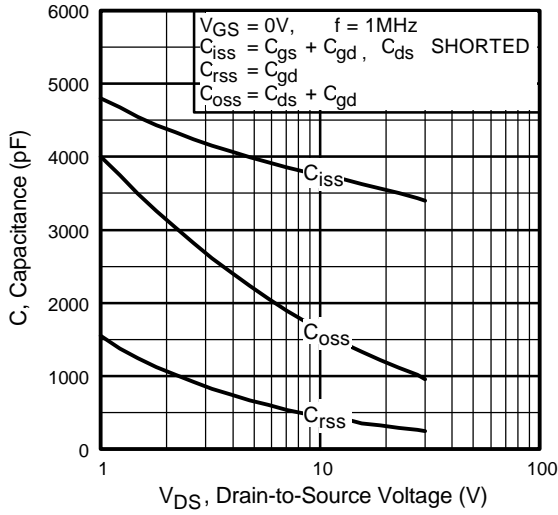

Fig 5. Typical Capacitance Vs. Drain-to-Source Voltage

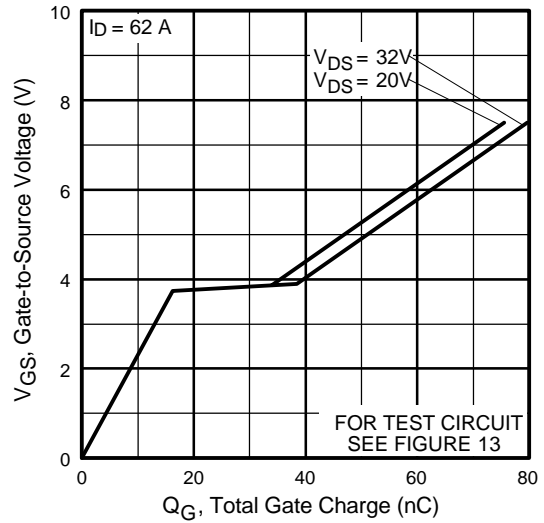

Fig 6. Typical Gate Charge Vs. Gate-to-Source Voltage

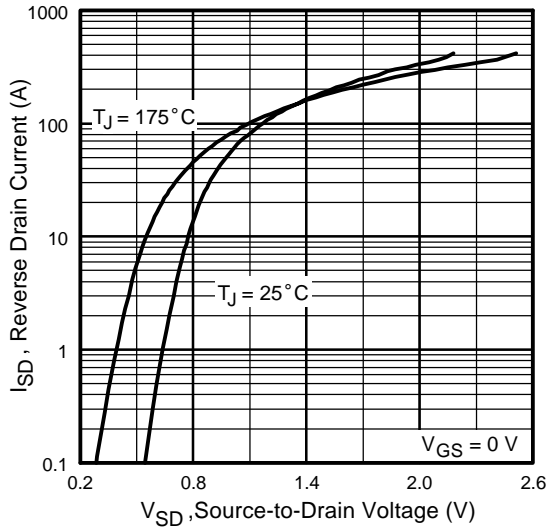

Fig 7. Typical Source-Drain Diode Forward Voltage

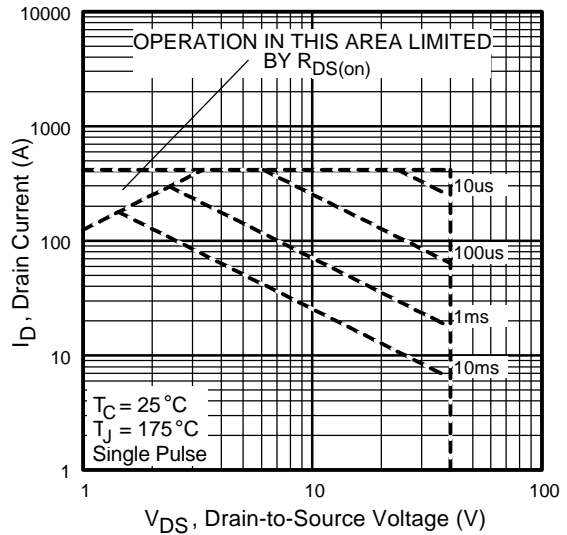

Fig 8. Maximum Safe Operating Area

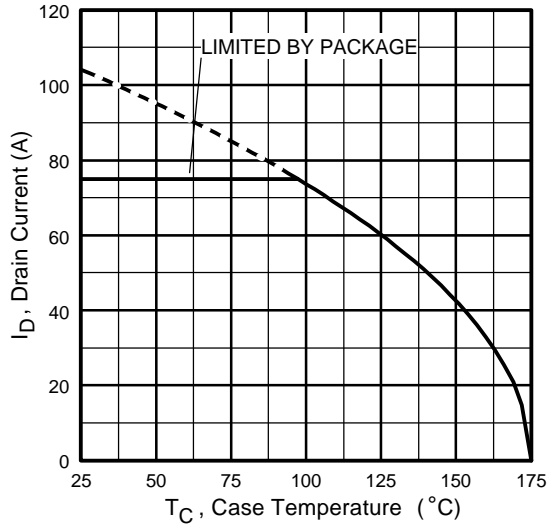

Fig 9. Maximum Drain Current Vs. Case Temperature

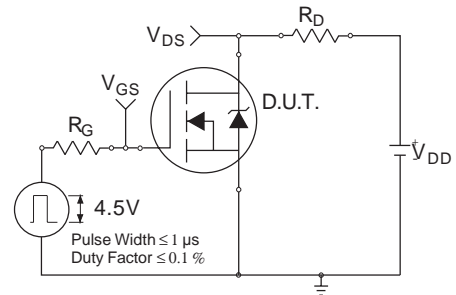

Fig 10a. Switching Time Test Circuit

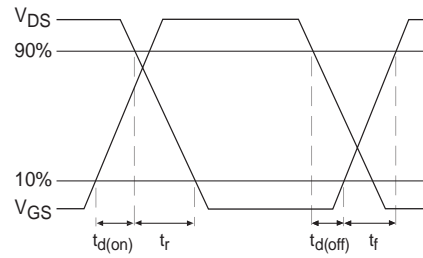

Fig 10b. Switching Time Waveforms

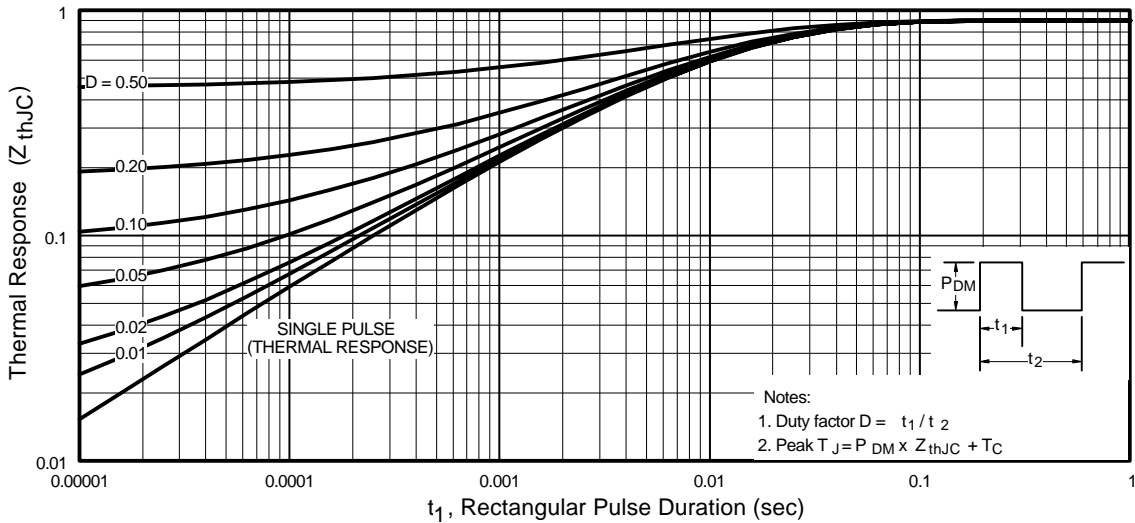

Fig 11. Maximum Effective Transient Thermal Impedance, Junction-to-Case

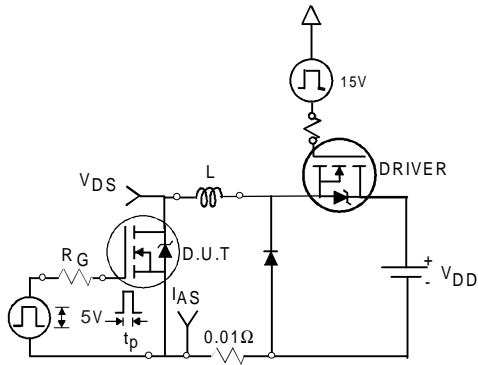

Fig 12a. Unclamped Inductive Test Circuit

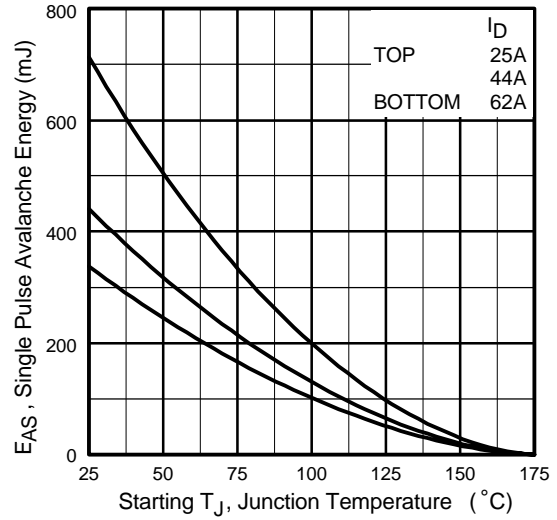

Fig 12c. Maximum Avalanche Energy Vs. Drain Current

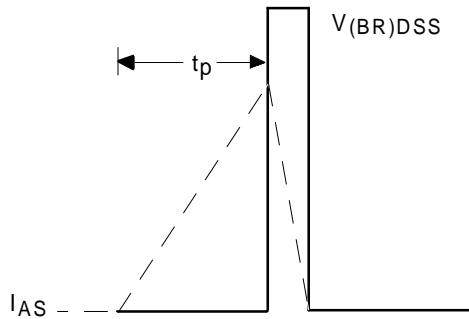

Fig 12b. Unclamped Inductive Waveforms

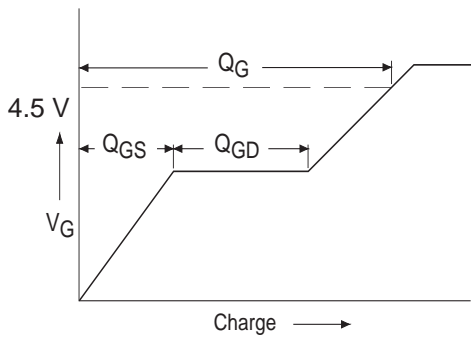

Fig 13a. Basic Gate Charge Waveform

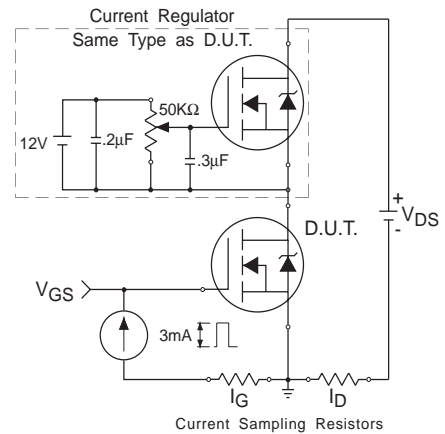
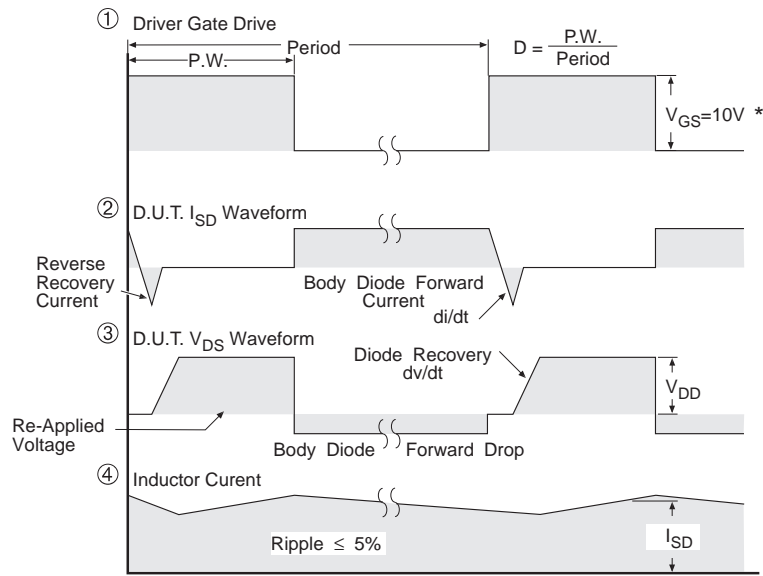
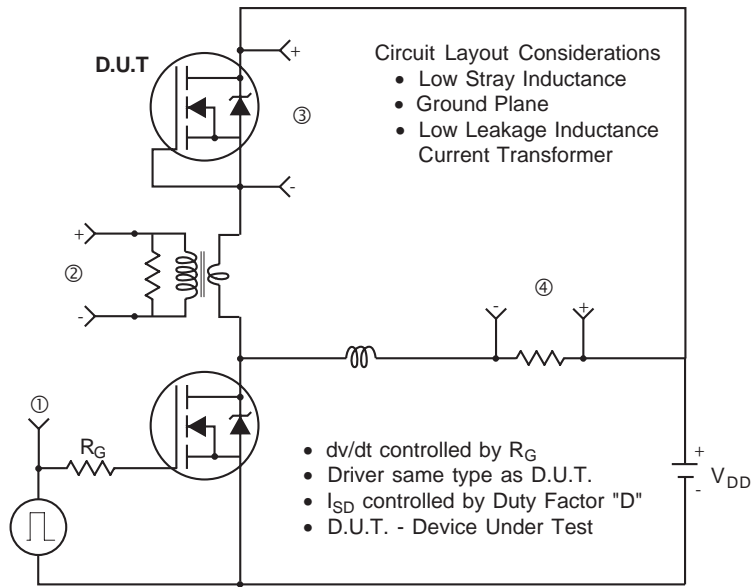

Fig 13b. Gate Charge Test Circuit

Peak Diode Recovery dv/dt Test Circuit



* $V_{GS} = 5V$ for Logic Level Devices

Fig 14. For N-Channel HEXFETS

IRL1104S/L



D²Pak Package Details

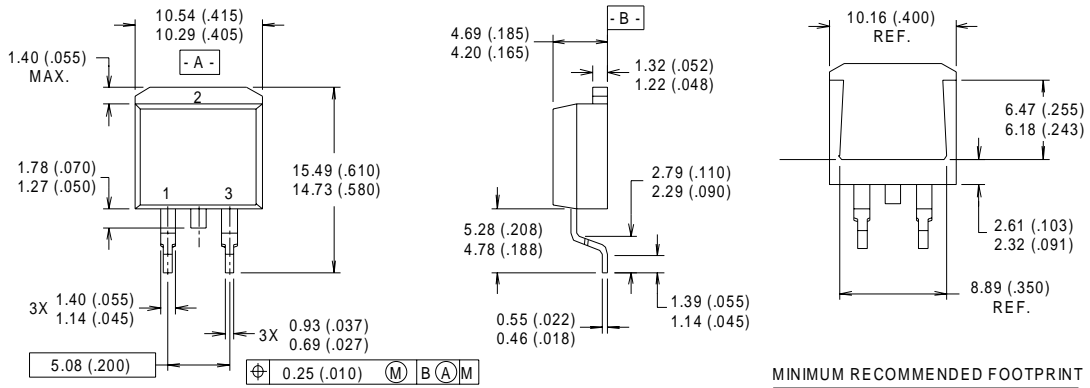

- NOTES:
- 1 DIMENSIONS AFTER SOLDER DIP.
 - 2 DIMENSIONING & TOLERANCING PER ANSI Y14.5M, 1982.
 - 3 CONTROLLING DIMENSION : INCH.
 - 4 HEATSINK & LEAD DIMENSIONS DO NOT INCLUDE BURRS.

- LEAD ASSIGNMENTS
- 1 - GATE
 - 2 - DRAIN
 - 3 - SOURCE

MINIMUM RECOMMENDED FOOTPRINT

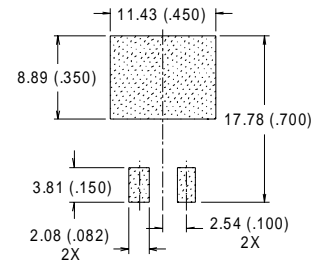

Part Marking

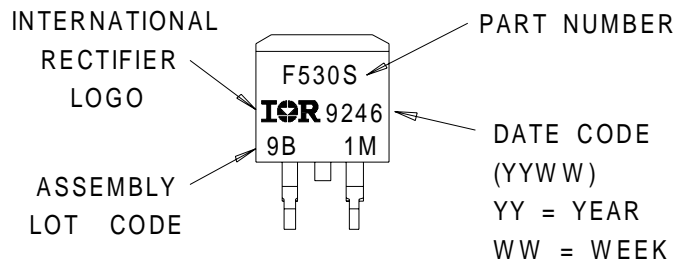

TO-262 Package Details

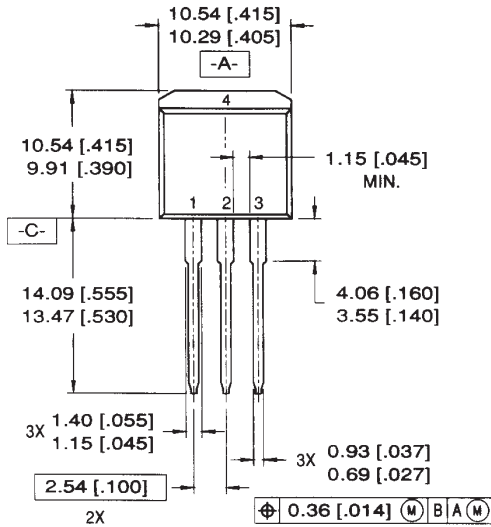

LEAD ASSIGNMENTS

- 1 = GATE 3 = SOURCE
- 2 = DRAIN 4 = DRAIN

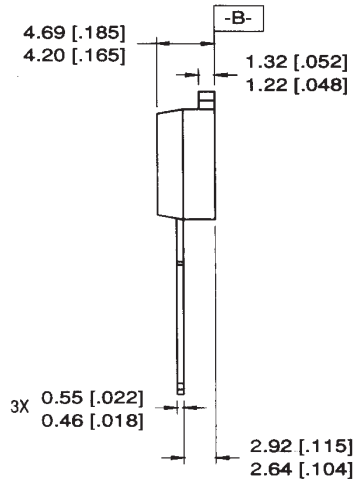

NOTES:

1. DIMENSIONING & TOLERANCING PER ANSI Y14.5M-1982
2. CONTROLLING DIMENSION: INCH.
3. DIMENSIONS ARE SHOWN IN MILLIMETERS [INCHES].
4. HEATSINK & LEAD DIMENSIONS DO NOT INCLUDE BURRS.

Part Marking

EXAMPLE: THIS IS AN IRL3103L
 LOT CODE 1789
 ASSEMBLED ON WW 19, 1997
 IN THE ASSEMBLY LINE "C"

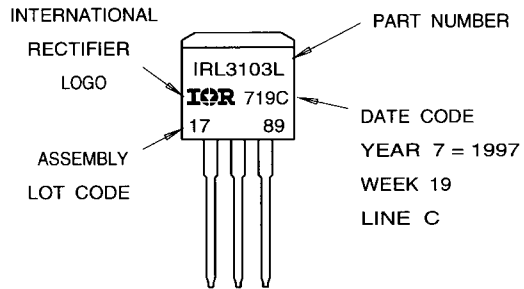

IRL1104S/L

International
IR Rectifier

D²Pak Tape and Reel

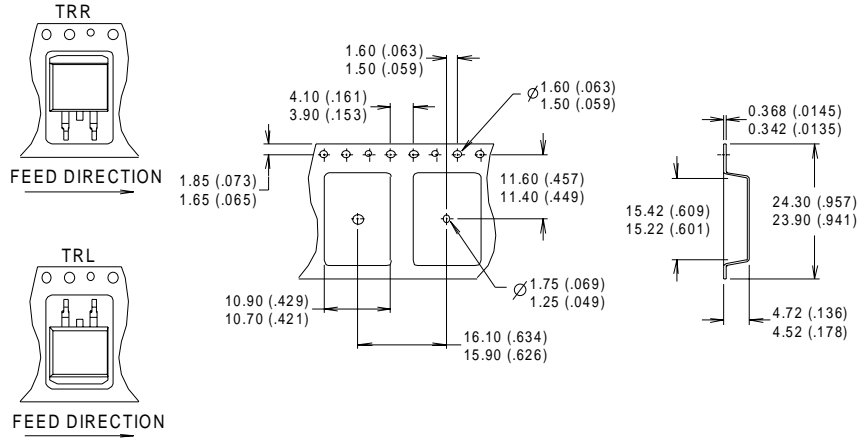

- NOTES :
1. CONFORMS TO EIA-418.
 2. CONTROLLING DIMENSION: MILLIMETER.
 - ③ DIMENSION MEASURED @ HUB.
 - ④ INCLUDES FLANGE DISTORTION @ OUTER EDGE.

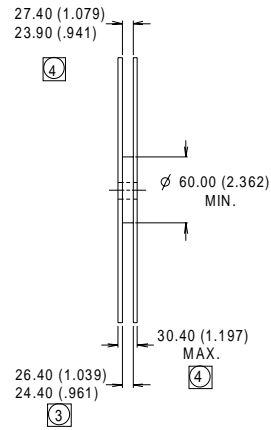

International
IR Rectifier

WORLD HEADQUARTERS: 233 Kansas St., El Segundo, California 90245, Tel: (310) 322 3331

IR GREAT BRITAIN: Hurst Green, Oxted, Surrey RH8 9BB, UK Tel: ++ 44 1883 732020

IR CANADA: 15 Lincoln Court, Brampton, Ontario L6T3Z2, Tel: (905) 453 2200

IR GERMANY: Saalburgstrasse 157, 61350 Bad Homburg Tel: ++ 49 6172 96590

IR ITALY: Via Liguria 49, 10071 Borgaro, Torino Tel: ++ 39 11 451 0111

IR FAR EAST: K&H Bldg., 2F, 30-4 Nishi-Ikebukuro 3-Chome, Toshima-Ku, Tokyo Japan 171 Tel: 81 3 3983 0086

IR SOUTHEAST ASIA: 1 Kim Seng Promenade, Great World City West Tower, 13-11, Singapore 237994 Tel: ++ 65 838 4630

IR TAIWAN: 16 Fl. Suite D. 207, Sec. 2, Tun Haw South Road, Taipei, 10673, Taiwan Tel: 886-2-2377-9936

<http://www.irf.com/>

Data and specifications subject to change without notice. 10/98

www.irf.com

Note: For the most current drawings please refer to the IR website at:
<http://www.irf.com/package/>

Looking for pricing, stock, or lifecycle information?

Click below to explore more details on WIN SOURCE:

 [View IRL1104S](#) on WIN SOURCE

 [Infineon Technologies](#) Information

Optimize Your Supply Chain with WIN SOURCE Solutions

-  Global Sourcing Solution
-  Obsolete Management
-  Cost Control Management
-  Shortage Management
-  Alternative Solution
-  Excess Inventory Management