



**THE DATASHEET OF
IRS27952STRPBF**



RESONANT HALF-BRIDGE CONVERTER CONTROL IC

Features

- Simple primary-side control solution for fixed and variable frequency DC-DC resonant converters.
- Max 500kHz per channel output with 50% duty cycle
- Floating channel bootstrap operation up to +600Vdc
- Programmable minimum and maximum switching frequency
- Programmable soft start frequency and soft start time
- Programmable dead time
- Micropower start-up & ultra low quiescent current
- Over-current protection using low side MOSFET Rds(on)
- User initiated micropower “Sleep mode”
- Under-voltage Lockout
- Simple design with minimal component count.
- Lead-free

Typical Application

- LCD & PDP TV
- Telecom SMPS, PC SMPS
- Home Audio Systems

Product Summary

Topology	Half-Bridge
V _{OFFSET}	600 V
V _{OUT}	V _{CC}
I _{O+} & I _{O-} (typical)	300 mA & 900 mA
Dead-time (programmable)	200ns~2us

Package Options

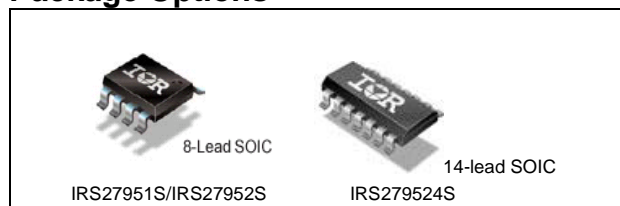

Ordering Information

Base Part Number	Package Type	Standard Pack		Complete Part Number
		Form	Quantity	
IRS27951	SOIC8N	Tube/Bulk	95	IRS27951SPBF
		Tape and Reel	2500	IRS27951STRPBF
IRS27952	SOIC8N	Tube/Bulk	95	IRS27952SPBF
		Tape and Reel	2500	IRS27952STRPBF
IRS279524	SOIC14N	Tube/Bulk	55	IRS279524SPBF
		Tape and Reel	2500	IRS279524STRPBF

Typical Application Diagram

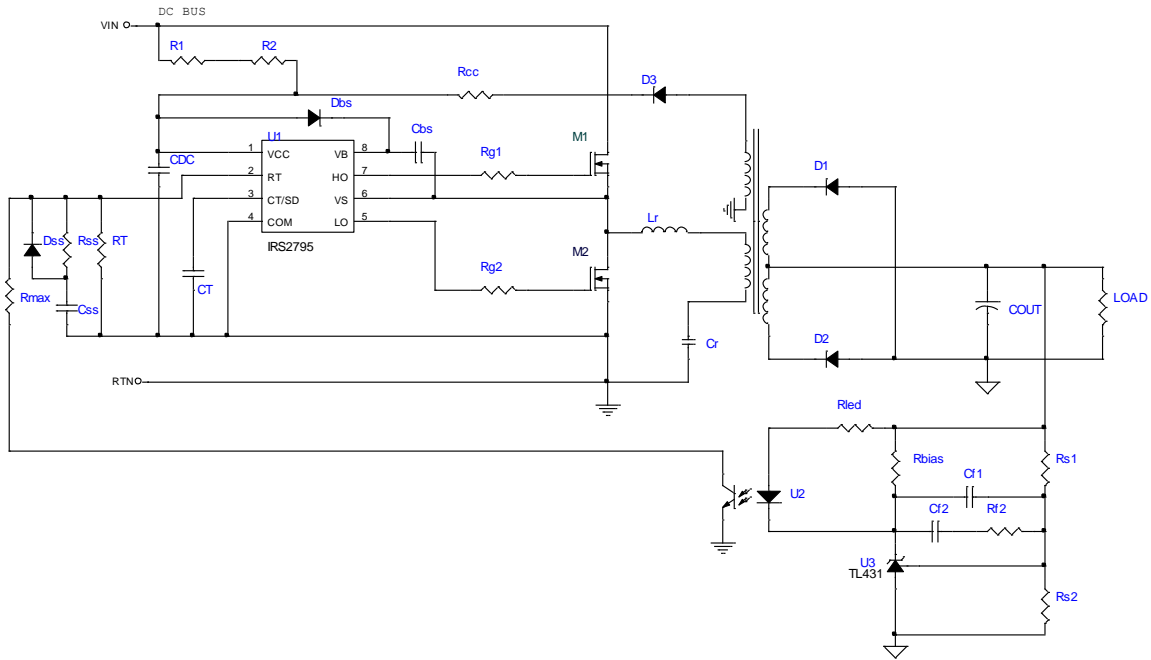

Table of Contents	Page
Ordering Information	1
Typical Application Diagram	2
Absolute Maximum Ratings	5
Recommended Operating Conditions	5
Electrical Characteristics	6
Functional Block Diagram	8
Input/Output Pin Equivalent Circuit Diagram	9
Lead Definitions	10
Lead Assignments	10
State Diagram	12
Application Information and Additional Details	13
Package Details	23
Tape and Reel Details	25
Part Marking Information	27
Qualification Information	28

Description

The IRS2795(1,2)(4) is a self oscillating half-bridge driver IC for DC-DC resonant converter applications, especially the LLC resonant half-bridge converter. The frequency and dead time can be programmed externally using two external components. The IC offers over current protection using the on state resistance of the low-side MOSFET. The IC can be disabled by externally pulling the voltage at the CT/SD pin below its enable voltage threshold

Absolute Maximum Ratings

Absolute maximum ratings indicate sustained limits beyond which damage to the device may occur. All voltage parameters are absolute voltages referenced to COM, all currents are defined positive into any lead. The thermal resistance and power dissipation ratings are measured under board mounted and still air conditions.

Symbol	Definition	Min.	Max.	Units	
V _{CC}	Supply Voltage	-0.3	25	V	
V _B	High-side Floating Supply Voltage	-0.3	625		
V _S	High-side Floating Supply Offset Voltage	V _B - 25	V _B + 0.3		
V _{HO}	High-side Floating Output Voltage	V _S - 0.3	V _B + 0.3		
V _{LO}	Low-side Output Voltage	-0.3	V _{CC} + 0.3		
V _{CT}	CT/SD Pin Voltage	-0.3	V _{CC} + 0.3		
V _{RT}	RT Pin Voltage	-0.3	V _{CC} + 0.3		
I _{RT}	RT pin source current	---	2	mA	
dV _S /dt	Allowable offset voltage slew rate	-50	50	V/ns	
T _J	Operating Junction Temperature	-40	150	°C	
T _S	Storage Temperature	-55	150		
P _D	Package power dissipation @ TA ≤ 25°C	(8 lead SOIC)	—	0.833	W
		(14 lead SOIC)	—	1.04	
R _{thJA}	Thermal resistance, junction to ambient	(8 lead SOIC)	—	150	°C/W
		(14 lead SOIC)	—	120	

Recommended Operating Conditions

For proper operation the device should be used within the recommended conditions.

Symbol	Definition	Min.	Max.	Units
V _{BS}	High-side floating supply voltage	10	V _{CC}	V
V _S	Steady-state high-side floating supply offset voltage	-3.0 [†]	600	
V _{CC}	Supply voltage	12	18	
f _{sw}	Switching Frequency	---	500	kHz

[†] Care should be taken to avoid output switching conditions where the V_S node flies inductively below ground by more than 5 V.

Recommended Component Values

Symbol	Component	Min.	Max.	Units
R _{RT}	RT pin resistor value	2	100	kΩ
C _{CT}	CT pin capacitor value	200	2000	pF

Electrical Characteristics

VCC=VBS=15V, VS=0V, CVCC=CBS=0.1uF, CLO=CHO=1nF, RT=50.5kΩ, CT=200pF and TA = 25°C unless otherwise specified. The output voltage and current (VO and IO) parameters are referenced to COM and are applicable to the respective HO and LO output leads.

Symbol	Definition	Min	Typ	Max	Units	Test Conditions
Low Voltage Supply Characteristics						
V _{CCUV+}	V _{CC} turn on threshold	10.1	11	11.9	V	N/A
V _{CCUV-}	V _{CC} turn off threshold (Under Voltage Lock Out)	8.1	9	9.9		
V _{CCUVHYS}	V _{CC} undervoltage lockout hysteresis	---	2	---		
I _{CCSTART}	V _{CC} startup current	---	50	100	μA	V _{CC} = V _{CCUV+} - 0.1V
I _{SLEEP}	Sleep mode V _{CC} supply current	---	150	200		V _{CT/SD} < V _{EN2} , V _{BS} =0V
I _{QCC}	Quiescent V _{CC} supply current	---	2	2.5	mA	V _{EN1} < V _{CT/SD} < 4.5V
I _{CC46KHz}	V _{CC} operating current @ f _{osc} = 46KHz	---	3.1	4.5		RT=50.5kΩ
I _{CC285KHz}	V _{CC} operating current @ f _{osc} = 285KHz	---	8.7	11		RT=7.32kΩ
Floating Supply Characteristics						
V _{BSUV+}	V _{BS} turn on threshold	7.6	8.5	9.4	V	N/A
V _{BSUV-}	V _{BS} turn on threshold (Under Voltage Lock Out)	7	7.9	8.8		
V _{BSUVHYS}	V _{BS} undervoltage lockout hysteresis	---	0.6	---		
I _{LKVS}	VS Offset supply leakage current	---	---	50	μA	V _B = V _S = 600 V
I _{BSSTART}	V _{BS} startup current	---	50	100		V _{BS} ≤ V _{BSUV+} - 0.1V
I _{QBS}	Quiescent V _{BS} supply current	---	50	100		V _{EN1} < V _{CT/SD} < 4.5V
I _{BS46KHz}	V _{BS} operating current @ f _{osc} = 46KHz	---	1	1.5	mA	RT=50.5kΩ
I _{BS285KHz}	V _{BS} operating current @ f _{osc} = 285KHz	---	5.7	7		RT=7.32kΩ
Oscillator I/O Characteristics						
f _{SW}	Oscillator frequency	44.3	46.6	48.9	kHz	CT=200pF, RT=50.5kΩ
		271	285	299		CT=200pF, RT=7.32kΩ
V _{CT+}	Upper CT ramp voltage threshold	---	5.0	---	V	GBD
V _{CT-}	Lower CT ramp voltage threshold	---	3.0	---		
I _{CTSTART}	CT/SD pin startup current	---	10	---	μA	V _{CT/SD} < V _{EN1}
V _{RT}	Voltage reference at RT pin	1.92	2.0	2.08	V	
CM	Current mirror ratio	---	1	---	A/A	
D	Output duty cycle (LO and HO)	---	50	---	%	
t _{DT}	High/low output dead time	170	210	250	ns	

Electrical Characteristics

VCC=VBS=15V, VS=0V, CVCC=CBS=0.1uF, CLO=CHO=1nF, RT=50.5kΩ, CT=200pF and TA = 25°C unless otherwise specified. The output voltage and current (VO and IO) parameters are referenced to COM and are applicable to the respective HO and LO output leads.

Symbol	Definition	Min	Typ	Max	Units	Test Conditions
Protection Characteristics						
R _{RTD}	RT discharge resistance	---	115	---	Ω	
R _{CTD}	CT/SD discharge resistance	---	115	---		
V _{EN1}	CT/SD rising enable voltage	0.75	1.05	1.4	V	
V _{EN2}	CT/SD standby voltage	0.6	0.85	1.1		
V _{ENHYST}	CT/SD enable hysteresis voltage	---	0.2	---		
V _{OCP}	Overcurrent VS threshold	1.9	2	2.1	V	IRS27951
		2.85	3	3.15		IRS27952(4)
t _{BLANK}	Leading edge blanking on LO	---	300	---	ns	GBD
t _{SD}	Shutdown propagation delay	---	300	---		GBD
Gate Driver Output Characteristics						
V _{OH}	Gate High Voltage	V _{CC} -1	---	---	V	I _{GATE} = 20mA
V _{OL}	Gate Low Voltage	---	0.05	0.15		I _{GATE} = -20mA
t _r	Output rise time	---	60	---	ns	C _{LOAD} =1nF
t _r	Output rise time	---	200	---		C _{LOAD} =4.7nF
t _f	Output fall time	---	16	---		C _{LOAD} =1nF
t _f	Output fall time	---	65	---		C _{LOAD} =4.7nF
M _{DT}	Output deadtime matching (DTLO-HO) – (DTHO-LO)	---	---	25	ns	
I _{O+}	Output source current	---	300	---	mA	GBD
I _{O-}	Output sink current	---	900	---		
R _{UP}	Pull up Resistance	---	20	---	Ω	I _{GATE} = 20mA
R _{DOWN}	Pull down Resistance	---	3	---		I _{GATE} = -20mA

† GBD: Guaranteed by design.

Functional Block Diagram

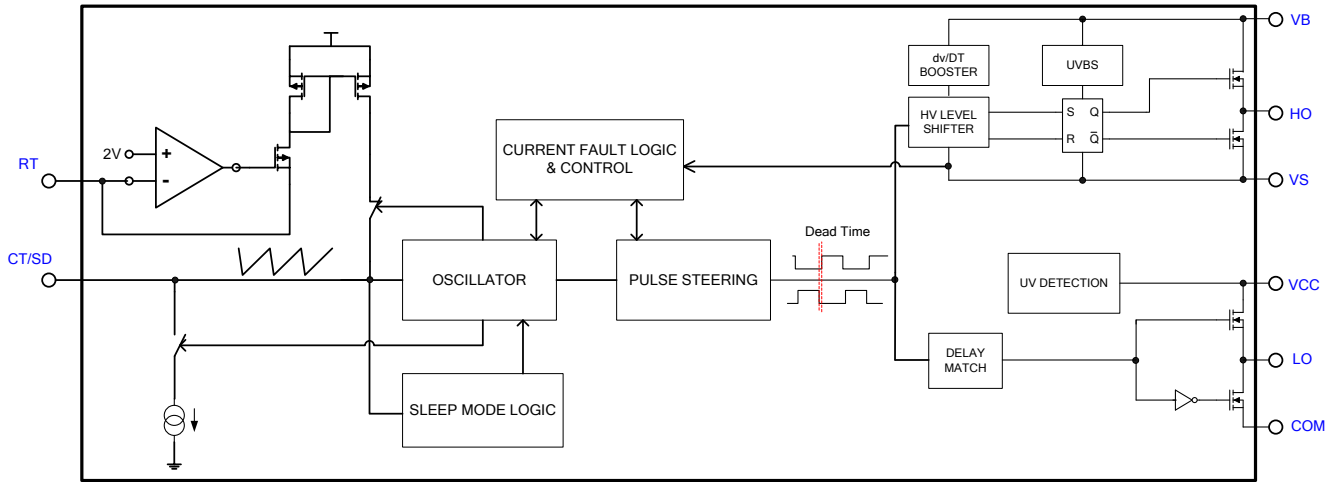

Input/Output Pin Equivalent Circuit Diagrams:

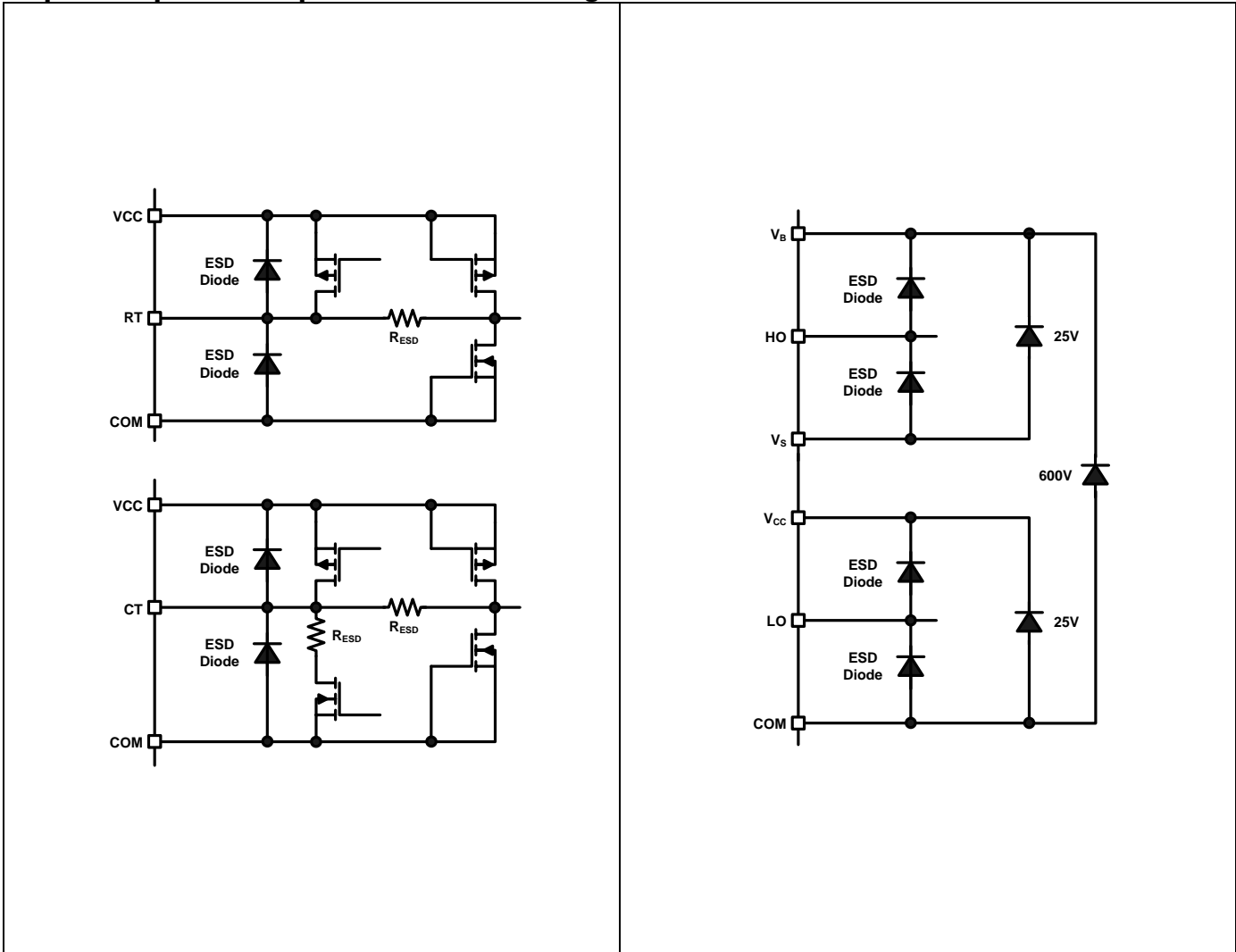

Lead Definitions:

Symbol	Description
VCC	Supply Voltage
RT	Oscillator timing resistor
CT/SD	Oscillator timing capacitor / shutdown
COM	Ground
LO	Low-side gate drive
VS	High-side gate drive return / HV current Sense
HO	High-side gate drive
VB	High-side floating supply voltage

Lead Assignments: IRS2795(1,2)S

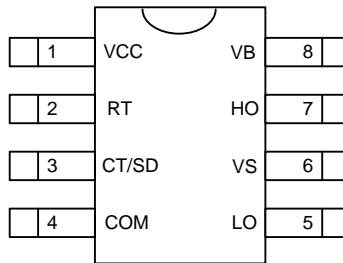

Lead Assignments: IRS279524S

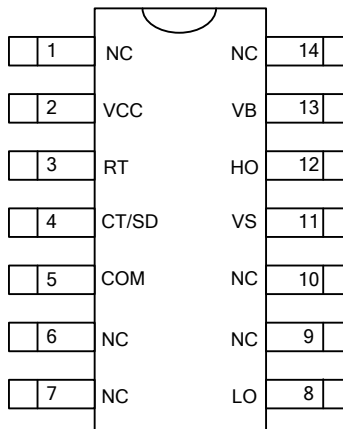

VCC: Power Supply Voltage

This is the supply voltage pin of the IC and sense node for the under-voltage lock out circuit. It is possible to turn off the IC by pulling this pin below the minimum turn off threshold voltage, V_{CCUV} , without damage to the IC. This pin is not internally clamped.

RT: Oscillator timing resistor

This pin provides a precise 2V reference and a resistor connected from this pin to COM defines a current that is used to set the minimum oscillator frequency. To close the feedback loop that regulates the converter output voltage by modulating the oscillator frequency, the phototransistor of an optocoupler will be connected to this pin through a resistor. The value of this resistor will set the maximum operating frequency. An R-C series connected from this pin to COM sets frequency shift at start-up to prevent excessive energy inrush (soft-start).

CT/SD: Oscillator timing capacitor /Shutdown

An external capacitor CT from this pin to COM sets the dead time and frequency of the oscillator. The CT pin has sawtooth waveform, which is charged up by the current reference programmed at RT pin during rising slope and is discharged by an internal fixed 2mA current source during the falling slope. The falling time of the sawtooth defines the dead-time.

At start-up, a 10uA current source charges this capacitor and the oscillator is enabled only when the voltage at this pin exceeds VEN1. The IC can also be used to enter sleep mode by externally pulling this pin below VEN2.

COM: Logic and Gate drive Ground

This is ground potential pin of the integrated control circuit. All internal circuits are referenced to this point.

LO: Low-side Gate Drive Output

The driver is capable of 0.3A source and 0.9A sink peak current to drive the lower MOSFET of the half-bridge leg. The pin is actively pulled to GND during UVLO.

VS: High Side Gate Return/Current Sense

This is the floating supply return. This pin also acts as a high voltage current sense pin and uses the low-side MOSFET $R_{DS(ON)}$ to detect an over current fault condition.

HO: High-side Gate Drive

The driver is capable of 0.3A source and 0.9A sink peak current to drive the high-side MOSFET in the half-bridge. A resistor internally connected to pin VS ensures that the pin is not floating during UVLO.

VB: High Side floating supply voltage

The bootstrap capacitor connected between this pin and VS is charged by the bootstrap diode when the low-side gate-drive is high.

State Diagram

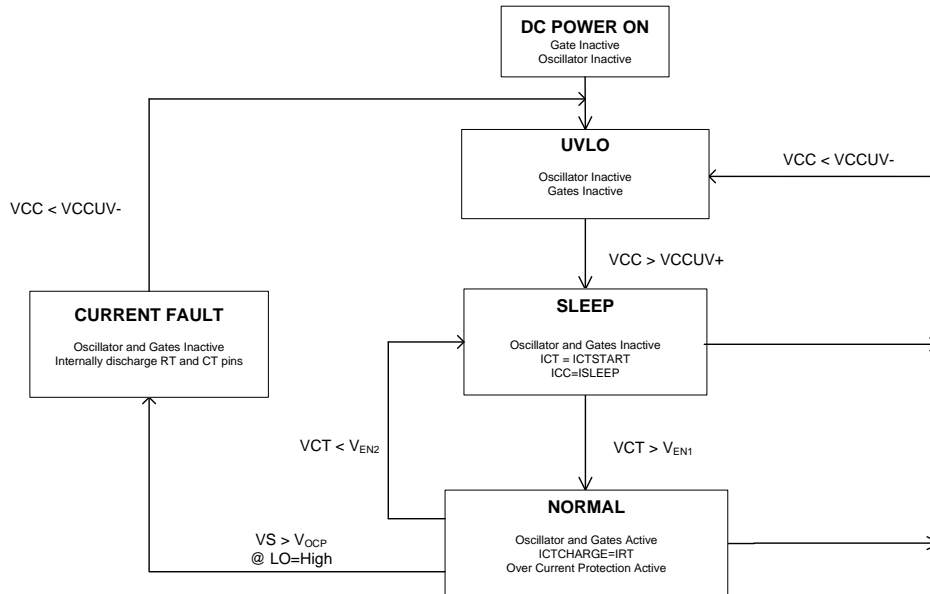

UVLO Mode

The IC remains in the UVLO condition until the voltage on the V_{CC} pin exceeds the V_{CC} turn on threshold voltage, V_{CCUV+} . During the time the IC remains in the UVLO state, the gate drive circuit is inactive and the IC draws a quiescent current of $I_{CC\ START}$. The UVLO mode is accessible from any other state of operation whenever the IC supply voltage condition of $V_{CC} < V_{CCUV-}$ occurs.

Sleep Mode

When V_{CC} exceeds the V_{CCUV+} threshold the IRS2795(1,2)(4) starts to charge up CT capacitor with I_{CT} startup current towards the enable threshold, V_{EN1} . During this period, the IC is in Sleep mode. The oscillator and gate drive circuits are disabled and the IC consumes I_{SLEEP} .

When the voltage at the CT/SD pin exceeds V_{EN1} , the IC is pulled out of sleep mode and the 2V reference voltage at the RT pin is enabled.

The IC can be placed in Sleep mode while operating in Normal mode by externally pulling the CT/SD pin below V_{EN2} . When this occurs, the RT pin of the IC is internally discharged to COM to ensure a system restart with soft-start.

Normal Mode

The IC enters in normal operating mode once the UVLO voltage and V_{EN1} has been exceeded. The RT pin voltage is 2V under normal mode. Gate drive signal appears at HO and LO with fixed 50% duty-cycle.

During this mode, the over-current protection scheme using the VS sense circuitry is active.

Current Fault Mode

When operating in Normal mode, the IC senses the voltage on the VS pin each time the low-side device is turned ON (with a leading edge blanking on LO, t_{blank}). When the voltage sensed exceeds V_{OCP} , the IC terminates the current gate pulse, disables the oscillator and gate drivers, and enters the Current Fault mode. When the IC enters this state, RT and CT/SD pins are internally discharged and IC supply voltage must be recycled before the IC can restart with soft-start again.

Application Information and Additional Details

Information regarding the following topics is included as subsections within this section of the datasheet.

- General Description
- IC Supply Circuit & Low start-up current
- Multi-function 2 Pin Oscillator
- Frequency and Dead-time Calculation
- User initiated Micropower Sleep mode
- Gate Drive Capability
- System Protection Features
- PCB Layout Tips
- Additional Documentation

General Description

The IRS2795(1,2)(4) is a double-ended controller for the resonant half-bridge topology. It provides complementary outputs with 50% (max) duty cycle; the high-side and low-side bridge devices are driven 180° out-of-phase for exactly the same time. A programmable dead-time inserted between the turn-OFF of one switch and the turn-ON of the other one guarantees soft-switching operation. The IC incorporates a multi-function oscillator that allows the designer to program all the necessary features to control a half bridge resonant switch-mode power supply featuring low standby power. The IC also incorporates additional protection features for robust operation and provides a high performance solution while minimizing external components, design time, and printed circuit board real estate.

The IC enables the designer to externally program all the following features using a 2 pin RC oscillator – operating frequency range (start-up, minimum and maximum frequency), dead time, soft-start time and sleep mode operation. IRS2795(1,2)(4) also uses IR’s proprietary high-voltage technology to implement a VS sensing circuitry that monitors the current through the low-side half bridge MOSFET for short circuit faults. By using the $R_{DS(ON)}$ of the low-side MOSFET, the IRS2795(1,2)(4) eliminates the need for an additional current sensing resistor, filter and current-sensing pin. This protection feature is latched and the thresholds are fixed at 2V for IRS27951 and 3V for IRS27952(4).

Finally, the controller IC also features a micro power startup current ($I_{CC} < 100\mu A$) and a user initiated sleep mode during which the IC power consumption is less than $200\mu A$ (@ $V_{CC} = 15V$). The sleep mode function allows system designs with reduced standby power consumption and can be used to meet stringent energy standards from Blue Angel, Energy Star etc.

IC Supply Circuit & Low start-up current

The UVLO circuit maintains the IC in UVLO mode if the VCC pin voltage is less than the VCC turn-on threshold, VCCON. If the VCC pin voltage drops below the UVLO threshold VCCUVLO at anytime after start-up, the IC is pushed back into UVLO mode. The current consumption in this mode is less than 100uA.

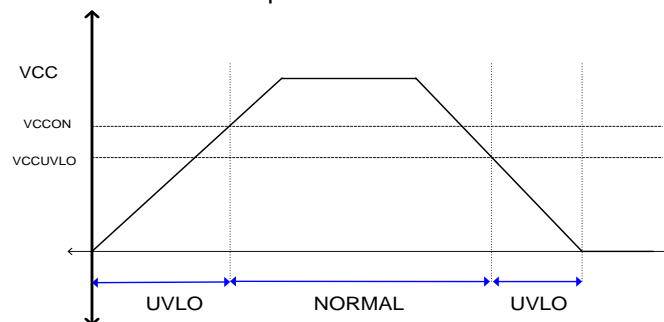

Figure 1: VCC Under Voltage Lockout

Multi-function 2 Pin Oscillator

The two pin oscillator is externally programmed by a resistor RT connected between pin#2 and COM and a capacitor CT, connected from pin#3 to COM. The RT pin provides an accurate 2V reference with a 2mA source capability (higher the current sourced by the pin, the higher is the oscillator frequency).

In normal operation, CT is charged by a current defined by the network connected at the RT pin. The oscillator ramp charges and discharges between the two ramp thresholds (3 and 5V). When the ramp voltage reaches 5V, it is internally discharged by a fixed current of 2mA. The fall time for the ramp corresponds to the dead time between the bridge devices.

At startup, a 10uA internal current source charges the oscillator capacitor at the CT pin to V_{EN1} . At this point, the IC is pulled out of sleep mode and the 2V reference voltage at the RT pin is enabled. The low-side device is now also turned ON to charge the bootstrap capacitor (this sequence at startup or while exiting sleep mode ensures that the low-side device is always switched on first to charge the bootstrap capacitor which will be ready to supply the high-side floating driver). The low-side device remains ON till the CT pin voltage reaches the upper ramp threshold of 5V (see Fig 2).

The programmable features for the oscillator are listed below-

- *Wide frequency range:*

The high-speed oscillator allows an output frequency from 50 kHz up to 500 kHz.

- *Programmable dead-time:*

The oscillator timing capacitor CT also programs the dead time between LO and HO.

- *Programmable soft-start time:*

In resonant converter applications, the output power delivered is an inverse function of frequency i.e. soft-start is achieved by sweeping the operating frequency from an initial high value until the control loop takes over. Additionally, the resonant tank has a non-linear frequency dependence that makes the converter's power transfer capability change little when the frequency is away from resonance and change very quickly as frequency approaches the resonant tank frequency.

An R-C series circuit (CSS + RSS) connected between the RT pin and COM programs the soft-start time for the converter. Initially, the capacitor CSS is totally discharged, so that the series resistor RSS is effectively in parallel to Rfmin and the resulting initial frequency is determined by RSS and RT only (the optocoupler's phototransistor is cut off). During this frequency sweep, the operating frequency will decay following the exponential charge of CSS, that is, initially it will change relatively quickly but the rate of change will get slower. The CSS capacitor charges until its voltage reaches 2V and, consequently, the current through RSS is reduced to zero.

The soft-start sequence is activated at normal startup and back to operation from Sleep mode.

- *Programmable start-up, minimum and maximum frequency:*

In resonant converter applications, it is important to operate the converter in the soft-switching region of operation. IRS2795(1,2)(4) offers a trimmed voltage reference ($\pm 4\%$ ¹) at the RT pin to accurately program the charging current. The converter switching frequency is trimmed to be within $\pm 5\%$ range for the desired region of operation.

¹ See revision history on the last page

- The effective resistance (RSS//RT) at pin#2 during IC power up and the CT capacitor program the start-up frequency of the converter.
- RT and CT program the minimum operating frequency.
- For closed loop systems with feedback control, a resistor Rfmax can be connected between the RT pin and the collector of the (emitter-grounded) phototransistor. The feedback loop modulates the current through the phototransistor and hence, the oscillator frequency for output voltage regulation.
- The converter maximum frequency is set by (Rmax//RT) and CT.

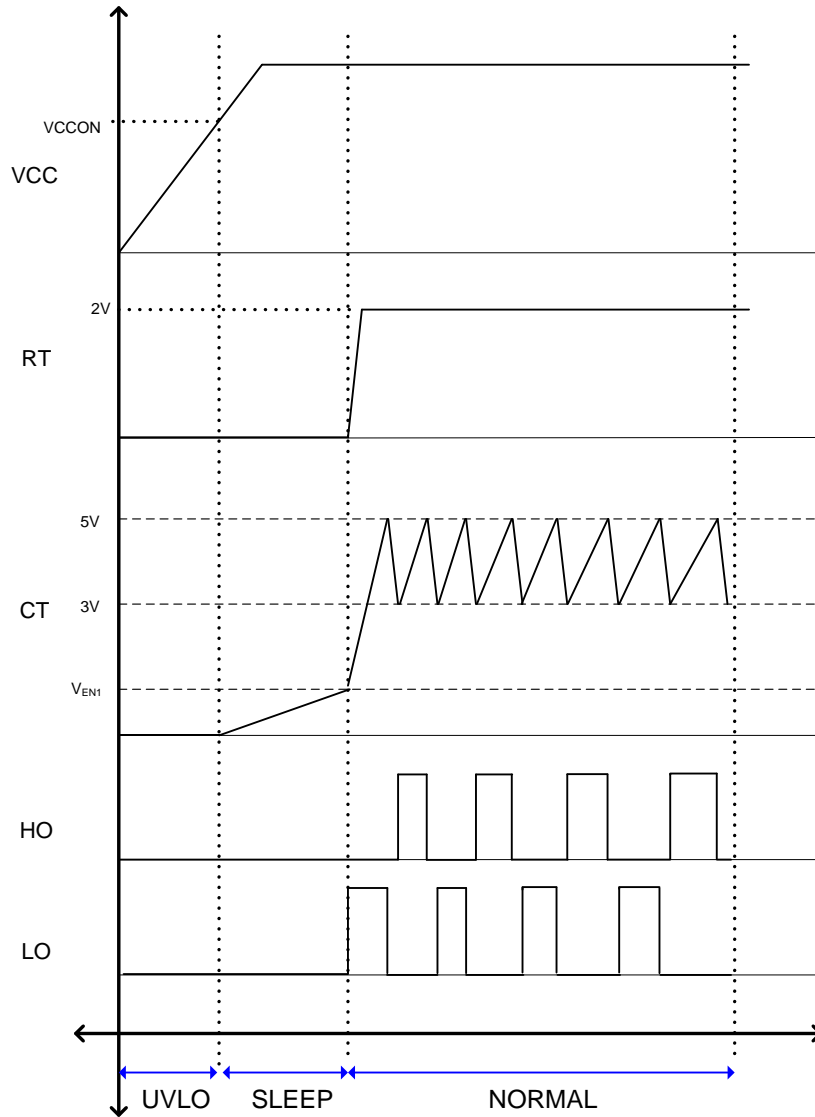

Figure 2: Typical startup waveforms with soft-start

Frequency and Dead-time Calculation

The dead time is calculated by the following equation:

$$t_{DT} = (0.85C_T + 40pF) \cdot \frac{2V}{2mA}$$

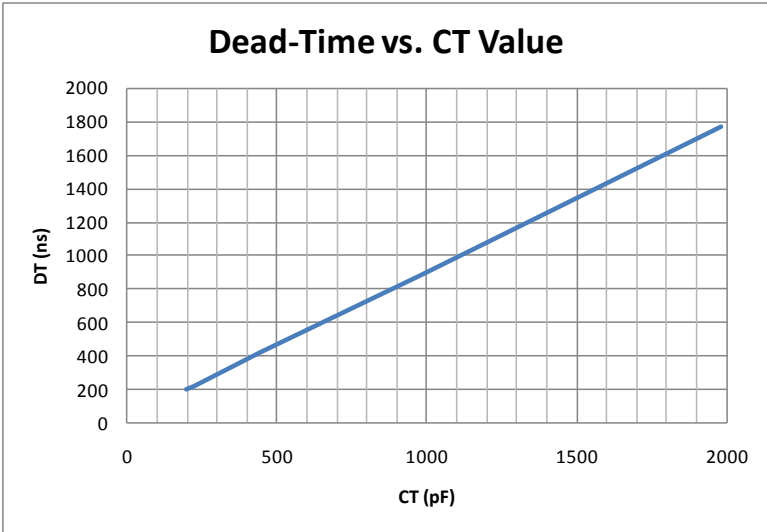

Figure 3: Dead-time with CT capacitor chart

The running frequency of the IRS2795(1,2)(4) is given by:

$$f_{sw} = \frac{1}{2 \cdot [R_{Teq} (0.85C_T + 40pF) + t_{DT}]}$$

R_{Teq} is the total equivalent resistance at RT pin.

Or just simply select the RT value from the frequency chart shown below:

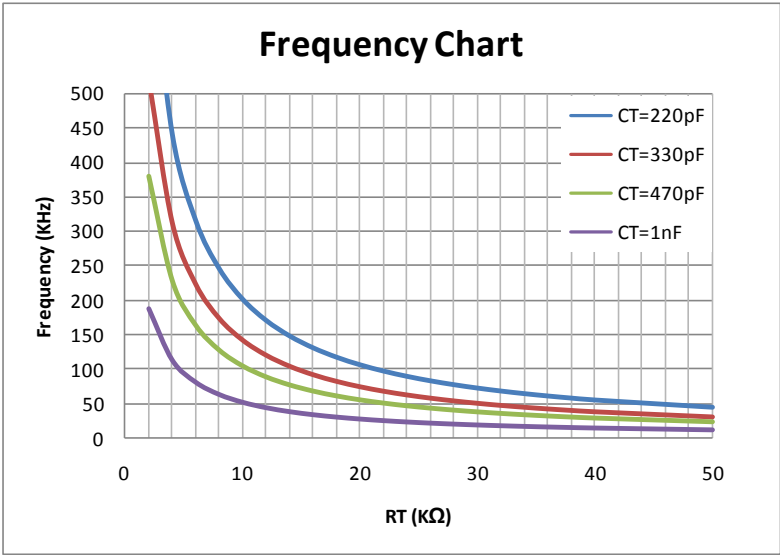

Figure 4: Switching frequency and RT selection

The maximum duty cycle is given by:

$$DC_{MAX} = 0.5 - (t_{DT} * f)$$

User initiated Micro Power Sleep mode

The IC can be actively pushed into a micropower sleep mode where current consumption is less than 200uA by pulling the CT pin below the sleep threshold V_{EN2} , even while the IC VCC is above VCCON. This mode allows the user to disable the resonant power converter during application standby modes in order to meet regulation standards (Blue Angel, Energy Start, Green Power etc). This IC disabling feature can also be use to implement other system protection features.

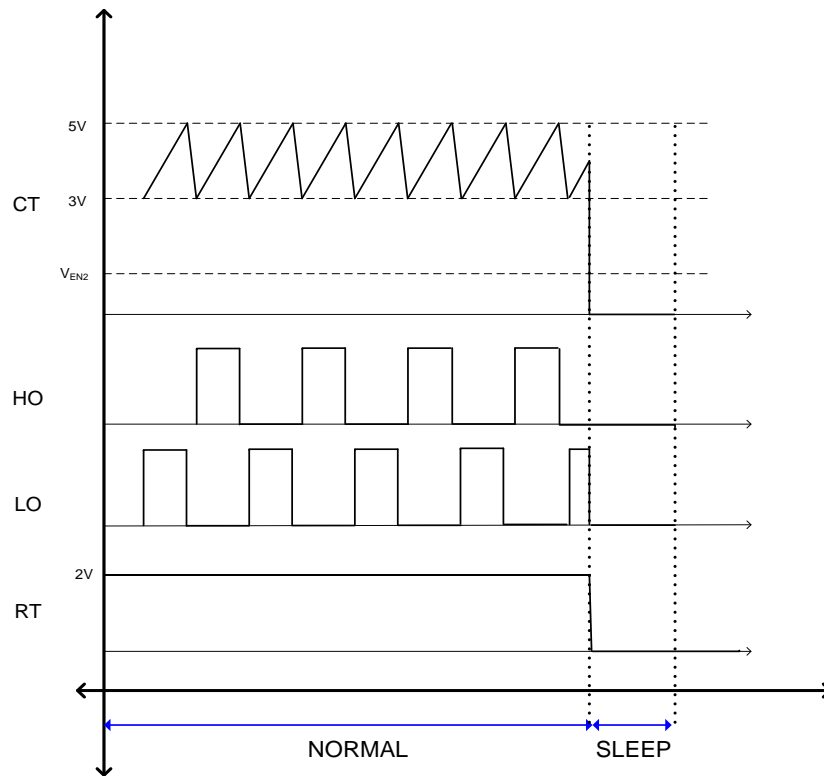

Figure 5: IC transition from normal to sleep mode by pulling down CT/SD pin

Gate Drive Capability

The gate drive output stage of the IC is capable of 0.3A peak source current and 0.9A peak sink current drive capability. Gate drive buffer circuits can be easily driven with the GATE pin of the IC to adapt to any system power level.

System Protection Features

IRS2795(1,2)(4) uses IR’s high-voltage technology to implement a VS sensing circuitry that monitors the current through the low-side half bridge MOSFET for short circuit faults. By using the $R_{DS(on)}$ of the low-side MOSFET, the need for an additional current sensing resistor is eliminated. The voltage at the VS node is sensed after a leading edge blanking time on LO. When the sensed voltage exceeds the protection thresholds, the IC enters Current Fault Mode (gate drive outputs are disabled and the oscillator pins are internally discharged to COM).

This protection feature is latched and the IC supply voltage must be pulled below the UVLO threshold and then again above VCCON in order to reset the latch and restart the IC.

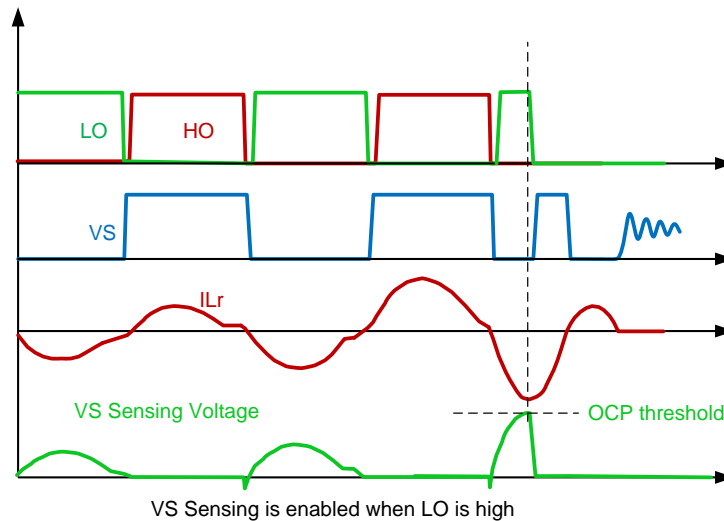

Figure 6: VS sensing over current protection

PCB Layout Tips

Distance between high and low voltage components: It is strongly recommended to place the components tied to the floating voltage pins (V_B and V_S) near the respective high voltage portions of the device.

Ground Plane: In order to minimize noise coupling, the ground plane should not be placed under or near the high voltage floating side.

Gate Drive Loops: Current loops behave like antennas and are able to receive and transmit EM noise. In order to reduce the EM coupling and improve the power switch turn on/off performance, the gate drive loops must be reduced as much as possible. For the low-side driver, the return of the drive loop must be directly connected to the COM pin of the IC and separate with signal ground (power ground and signal ground have star connection at COM pin).

Supply Capacitor: It is recommended to place a bypass capacitor (C_{IN}) between the V_{CC} and COM pins. A $1\mu\text{F}$ ceramic capacitor is suitable for most applications. This component should be placed as close as possible to the pins in order to reduce parasitic elements.

C_{BS} Capacitor: The C_{BS} capacitor should be placed as close as possible to the V_B and V_S pins.

Routing and Placement: 1) The IC has only one COM pin for both signal return and power return, so it is strongly recommended to route the signal ground and power ground separately and with a star connection at the COM pin. 2) The RT pin provides a current reference for the internal oscillator and needs to be kept as clean as possible to avoid frequency jittering or duty-cycle mismatch between high-side and low-side. The components connected to this pin must keep away from the high frequency switching loop such as the gate driver loop and the VS node. The PCB traces connected to RT pin also need to be kept away from any switching node. 3) Connect CT capacitor directly to COM pin, don't share the return with any other signal ground.

Layout Example:

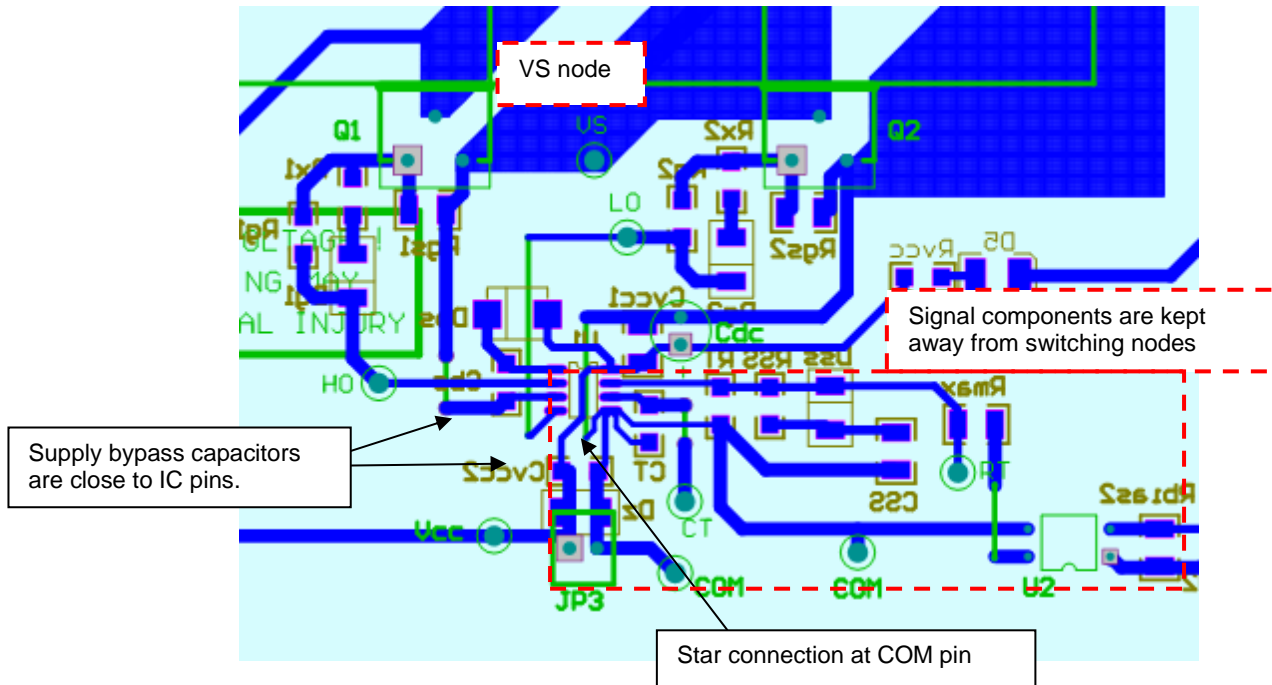

Additional Documentation

Please refer to application note AN-1160 for more design details of IRS2795(1,2)(4).

Several technical documents related to the use of HVICs are also available at www.irf.com; use the Site Search function and the document number to quickly locate them. Below is a short list of some of these documents.

- AN-1160: Design of Resonant Half-Bridge converter using IRS2795(1,2) Control IC
- DT97-3: Managing Transients in Control IC Driven Power Stages

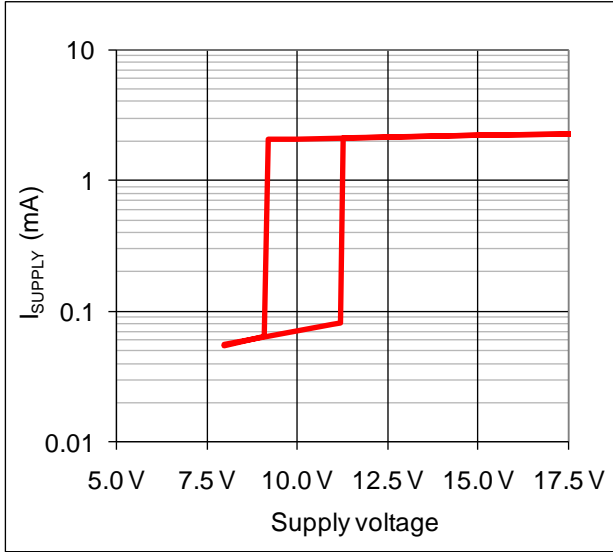

Figure 7: Supply Current vs. Supply Voltage

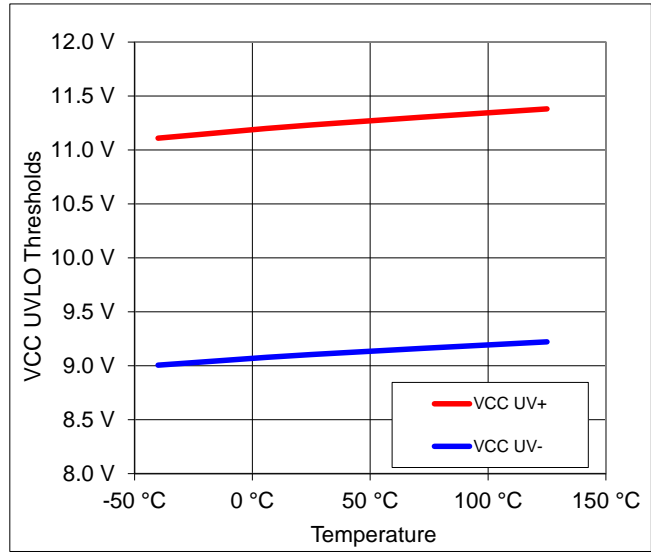

Figure 8: Undervoltage Lockout vs. Temperature

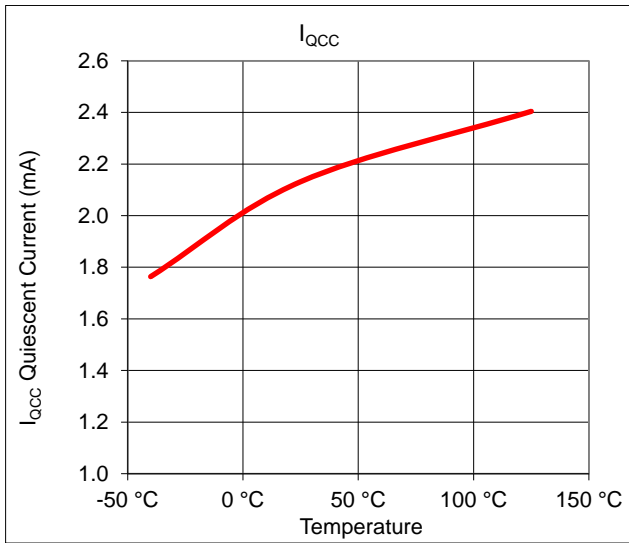

Figure 9: Icc Quiescent Current vs. Temperature

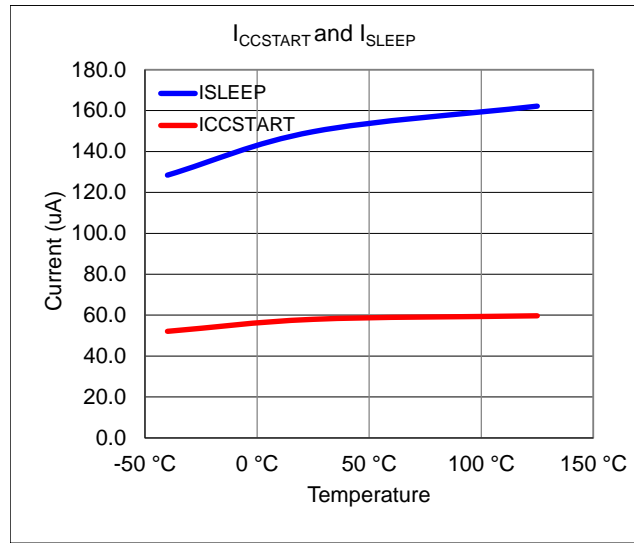

Figure 10: Startup Current and Sleep Current vs. Temperature

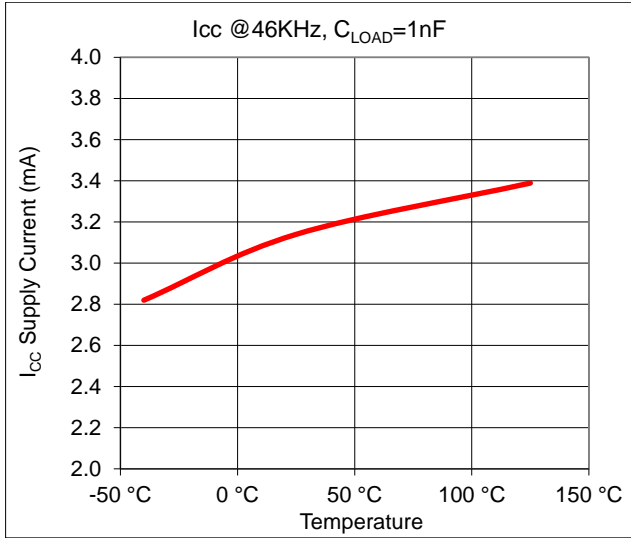

Figure 11: Icc Supply Current @1nF Load vs. Temperature

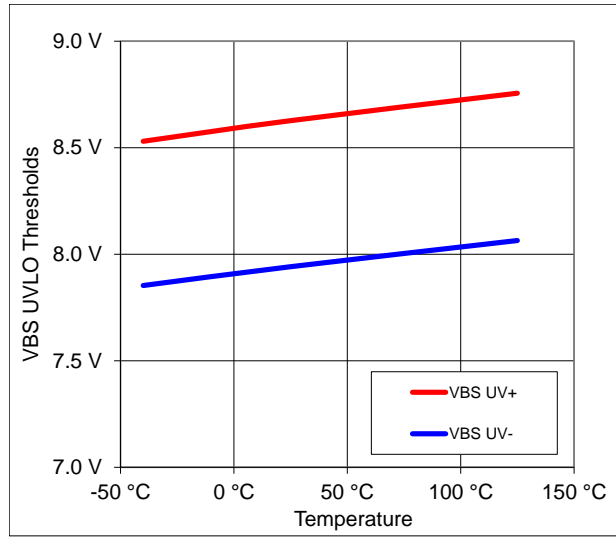

Figure 12: VBS Undervoltage Lockout vs. Temperature

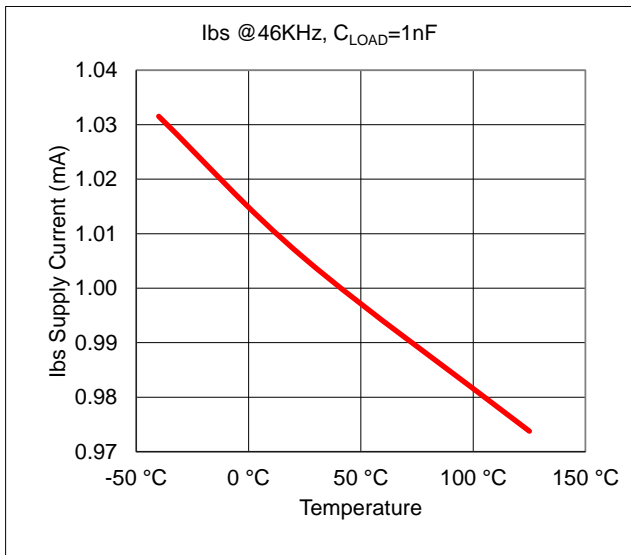

Figure 13: Ibs Current @1nF Load vs. Temperature

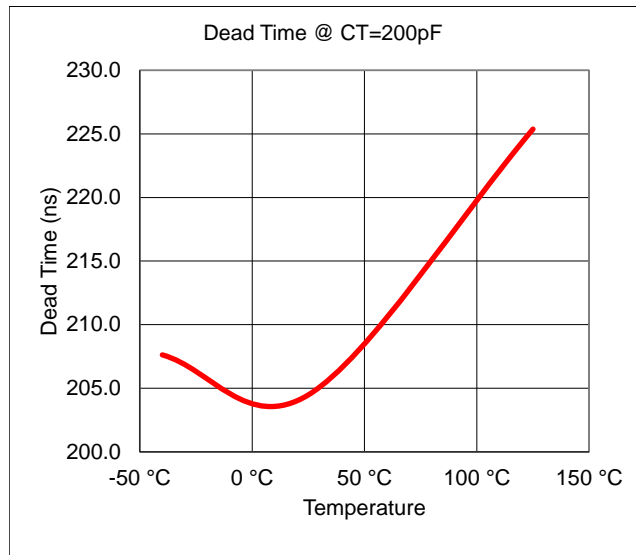

Figure 14: Dead-Time vs Temperature

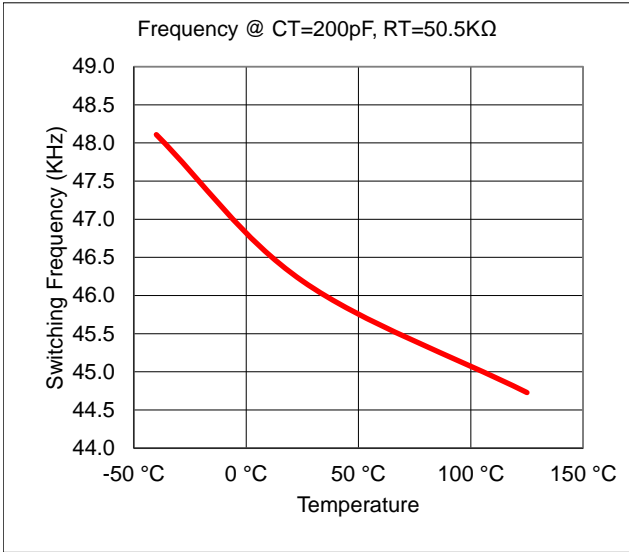

Figure 15: Switching Frequency vs. Temperature

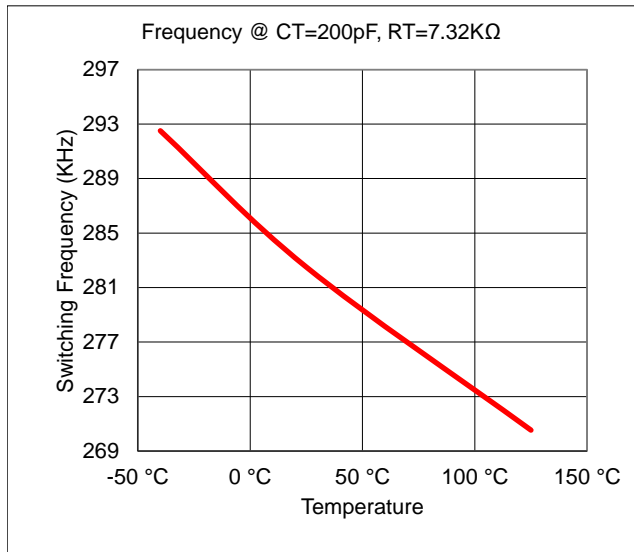

Figure 16: Switching Frequency vs. Temperature

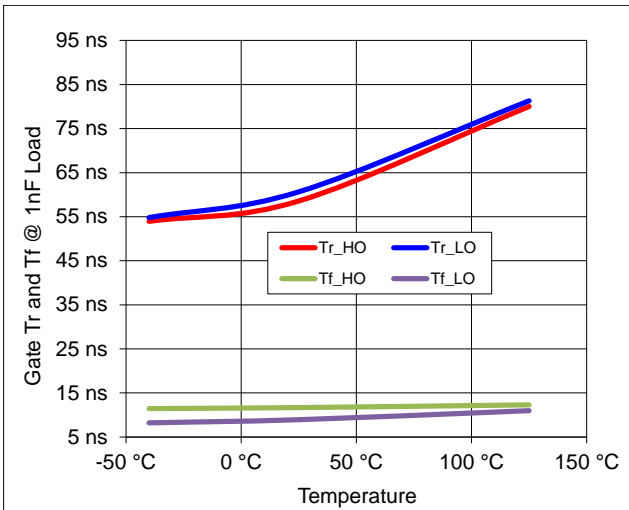

Figure 17: Gate Output Tr and Tf time @ 1nF Load vs. Temperature

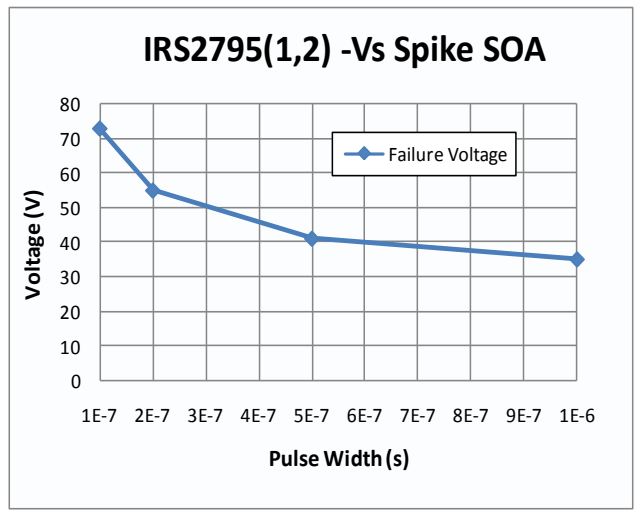
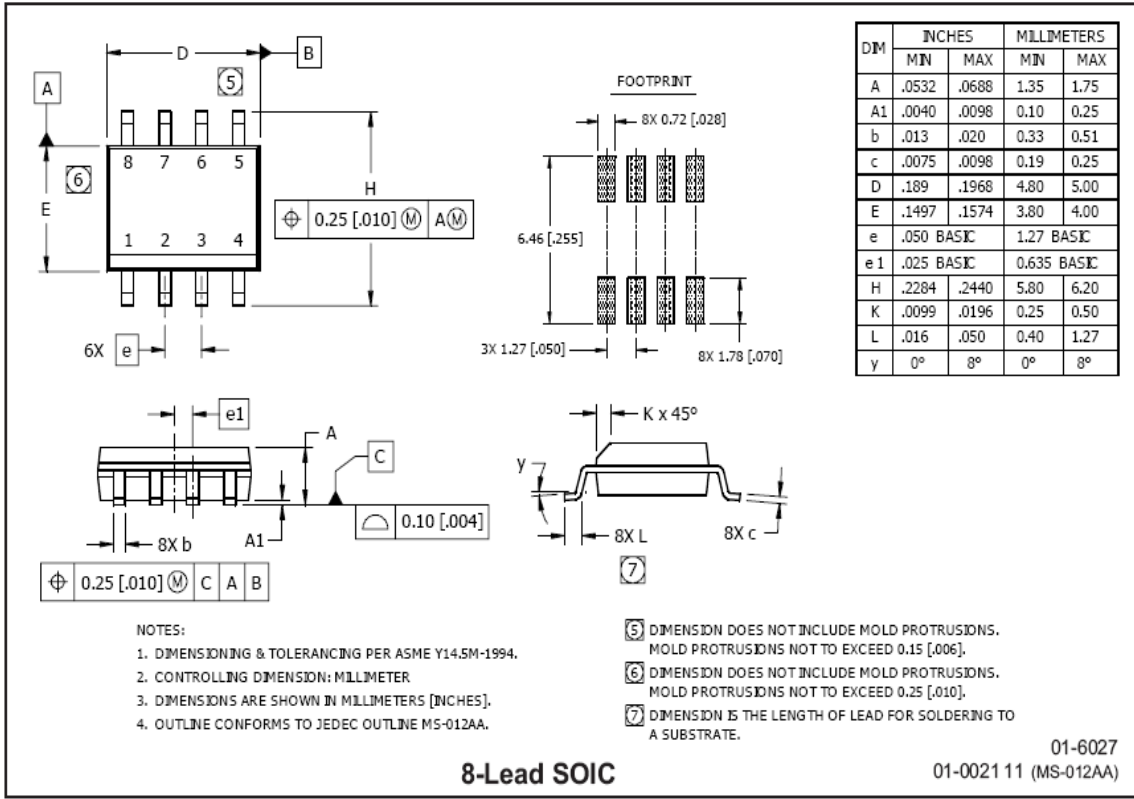

Figure 18: VS Negative Transient Safety Operation Area

Package Details: SOIC8N



- NOTES:
1. DIMENSIONING & TOLERANCING PER ASME Y14.5M-1994.
 2. CONTROLLING DIMENSION: MILLIMETER
 3. DIMENSIONS ARE SHOWN IN MILLIMETERS [INCHES].
 4. OUTLINE CONFORMS TO JEDEC OUTLINE MS-012AA.
 5. DIMENSION DOES NOT INCLUDE MOLD PROTRUSIONS. MOLD PROTRUSIONS NOT TO EXCEED 0.15 [0.006].
 6. DIMENSION DOES NOT INCLUDE MOLD PROTRUSIONS. MOLD PROTRUSIONS NOT TO EXCEED 0.25 [0.010].
 7. DIMENSION IS THE LENGTH OF LEAD FOR SOLDERING TO A SUBSTRATE.

Package Details: SOIC14N

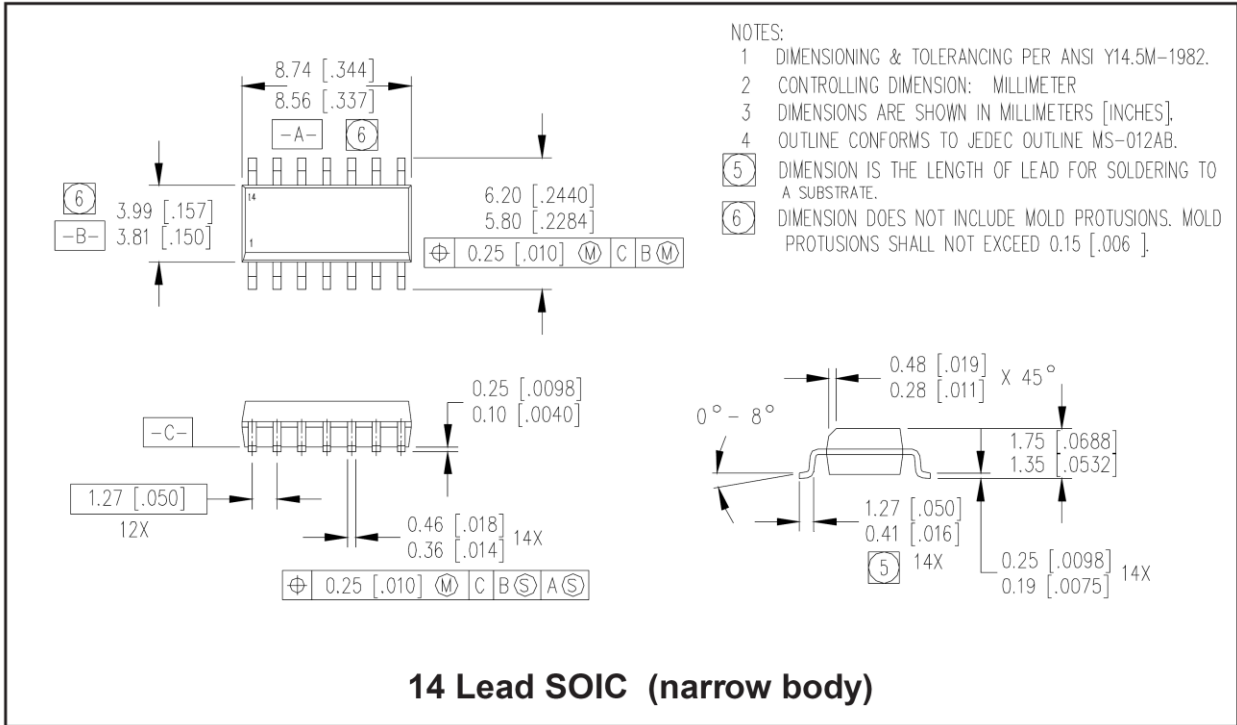

- NOTES:
- 1 DIMENSIONING & TOLERANCING PER ANSI Y14.5M-1982.
 - 2 CONTROLLING DIMENSION: MILLIMETER
 - 3 DIMENSIONS ARE SHOWN IN MILLIMETERS [INCHES].
 - 4 OUTLINE CONFORMS TO JEDEC OUTLINE MS-012AB.
 - 5 DIMENSION IS THE LENGTH OF LEAD FOR SOLDERING TO A SUBSTRATE.
 - 6 DIMENSION DOES NOT INCLUDE MOLD PROTUSIONS. MOLD PROTUSIONS SHALL NOT EXCEED 0.15 [0.006].

Tape and Reel Details: SOIC8N

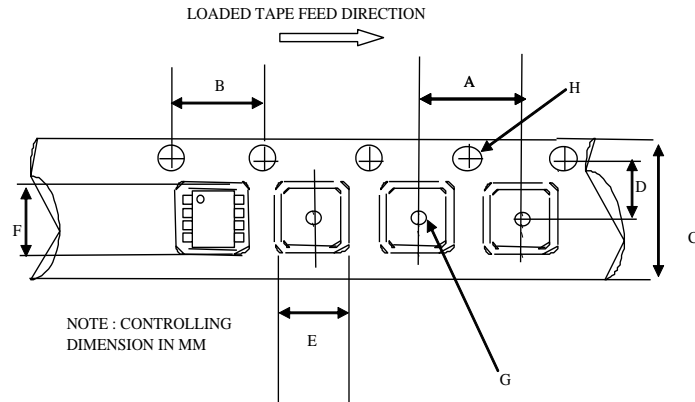

CARRIER TAPE DIMENSION FOR 8SOICN

Code	Metric		Imperial	
	Min	Max	Min	Max
A	7.90	8.10	0.311	0.318
B	3.90	4.10	0.153	0.161
C	11.70	12.30	0.46	0.484
D	5.45	5.55	0.214	0.218
E	6.30	6.50	0.248	0.255
F	5.10	5.30	0.200	0.208
G	1.50	n/a	0.059	n/a
H	1.50	1.60	0.059	0.062

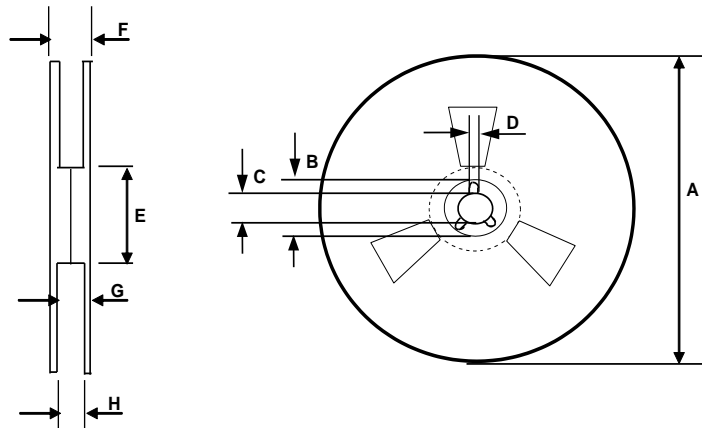

REEL DIMENSIONS FOR 8SOICN

Code	Metric		Imperial	
	Min	Max	Min	Max
A	329.60	330.25	12.976	13.001
B	20.95	21.45	0.824	0.844
C	12.80	13.20	0.503	0.519
D	1.95	2.45	0.767	0.096
E	98.00	102.00	3.858	4.015
F	n/a	18.40	n/a	0.724
G	14.50	17.10	0.570	0.673
H	12.40	14.40	0.488	0.566

Tape and Reel Details: SOIC14N

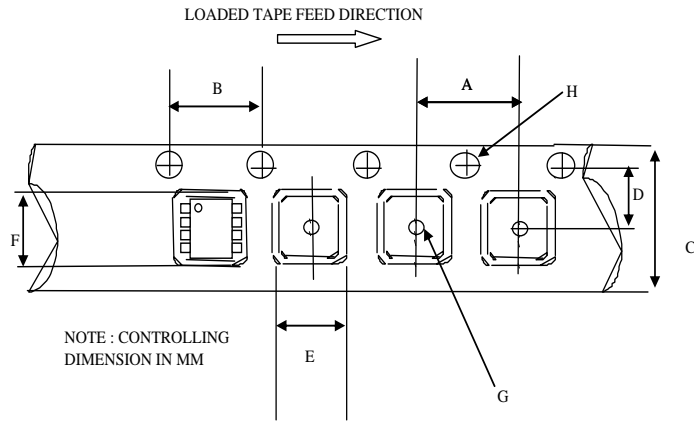

CARRIER TAPE DIMENSION FOR 14SOICN

Code	Metric		Imperial	
	Min	Max	Min	Max
A	7.90	8.10	0.311	0.318
B	3.90	4.10	0.153	0.161
C	15.70	16.30	0.618	0.641
D	7.40	7.60	0.291	0.299
E	6.40	6.60	0.252	0.260
F	9.40	9.60	0.370	0.378
G	1.50	n/a	0.059	n/a
H	1.50	1.60	0.059	0.062

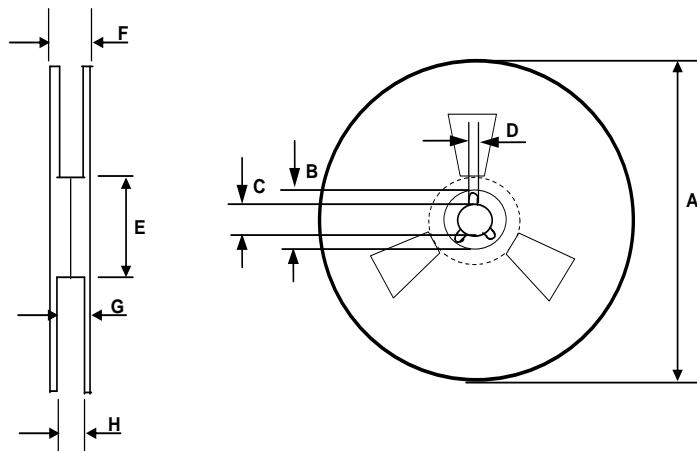

REEL DIMENSIONS FOR 14SOICN

Code	Metric		Imperial	
	Min	Max	Min	Max
A	329.60	330.25	12.976	13.001
B	20.95	21.45	0.824	0.844
C	12.80	13.20	0.503	0.519
D	1.95	2.45	0.767	0.096
E	98.00	102.00	3.858	4.015
F	n/a	22.40	n/a	0.881
G	18.50	21.10	0.728	0.830
H	16.40	18.40	0.645	0.724

Part Marking Information

SOIC8

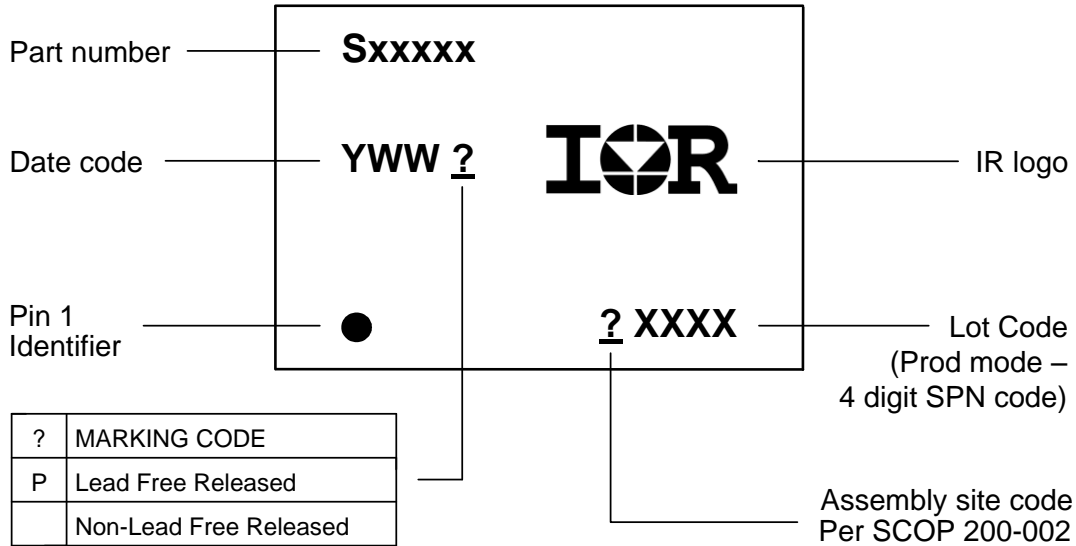

SOIC14

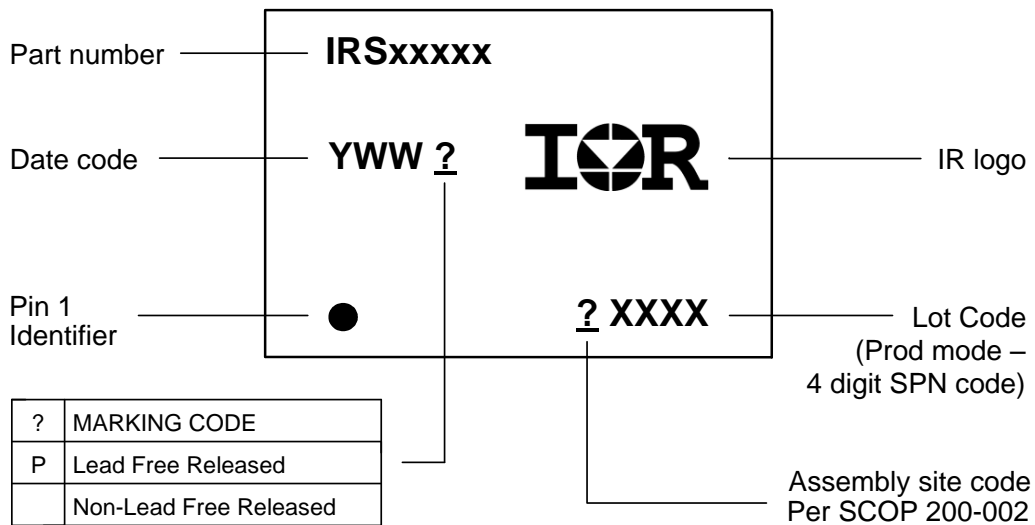

Qualification Information[†]

Qualification Level		Industrial ^{††}	
		Comments: This family of ICs has passed JEDEC's Industrial qualification. IR's Consumer qualification level is granted by extension of the higher Industrial level.	
Moisture Sensitivity Level		SOIC8N	MSL2 ^{†††} 260°C (per IPC/JEDEC J-STD-020C)
		SOIC14N	MSL2 ^{†††} 260°C (per IPC/JEDEC J-STD-020)
ESD	Machine Model	Class B (per JEDEC standard EIA/JESD22-A115-A)	
	Human Body Model	Class 2 (per EIA/JEDEC standard JESD22-A114-B)	
IC Latch-Up Test		Class I, Level A (per JESD78A)	
RoHS Compliant		Yes	

- † Qualification standards can be found at International Rectifier's web site <http://www.irf.com/>
- †† Higher qualification ratings may be available should the user have such requirements. Please contact your International Rectifier sales representative for further information.
- ††† Higher MSL ratings may be available for the specific package types listed here. Please contact your International Rectifier sales representative for further information.

The information provided in this document is believed to be accurate and reliable. However, International Rectifier assumes no responsibility for the consequences of the use of this information. International Rectifier assumes no responsibility for any infringement of patents or of other rights of third parties which may result from the use of this information. No license is granted by implication or otherwise under any patent or patent rights of International Rectifier. The specifications mentioned in this document are subject to change without notice. This document supersedes and replaces all information previously supplied.

For technical support, please contact IR's Technical Assistance Center
<http://www.irf.com/technical-info/>

WORLD HEADQUARTERS:
 233 Kansas St., El Segundo, California 90245
 Tel: (310) 252-7105

Revision History: **27 August 2015**

Previous Version: 8 November 2012

Page	Subjects (major changes since last revision)
14	Corrected the trimming range of RT reference voltage in Application Information section, from +/2% to +/-4% as indicated in electrical characteristic table.

Looking for pricing, stock, or lifecycle information?

Click below to explore more details on WIN SOURCE:

 [View IRS27952STRPBF on WIN SOURCE](#)

 [Infineon Technologies](#) Information

Optimize Your Supply Chain with WIN SOURCE Solutions

-  Global Sourcing Solution
-  Obsolete Management
-  Cost Control Management
-  Shortage Management
-  Alternative Solution
-  Excess Inventory Management